

PIETER ADAM<sup>TM</sup>  
LIGHTING & ACCESSORIES

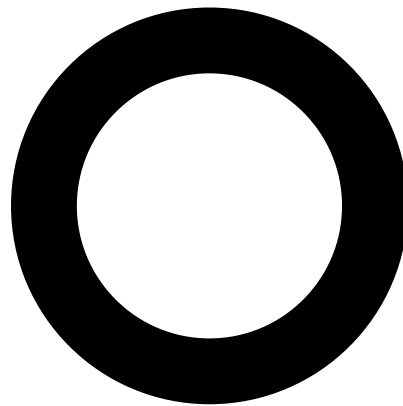

MADE OF MATERIALS LIKE BRASS,  
MARBLE, GLASS, SILK AND LEATHER.  
A STYLE FOR EVERY PERSON WHO  
APPRECIATES A STYLISH AND  
EXCLUSIVE DESIGN.

[WWW.PIETER-ADAM.COM](http://WWW.PIETER-ADAM.COM)

WHAT YOU SEE IS WHAT YOU GET



## PHILOSOPHY

Drawing from years of experience in exclusive lighting, Pieter Adam started his line of lighting as an alternative to the volatile, temporary and trendy mass production items available everywhere. His main focus was on quality and exclusivity with durability, craftsmanship and expertise being high on his priority list.

With a clean slate and full of ideas we began the Pieter Adam Collection with the key words contemporary, exclusive and stylish serving as the main design focus. Every detail and every piece was carefully thought out leaving nothing to chance.

Quality through expertise. Our many years of experience with bronze founders, glass blowers, granite refiners, and silk weavers enables our highly skilled craftsmen to make special limited edition pieces. As a result, we are able to meet special needs and requests, such as complete custom designed lighting plans for special projects.

Perfection is paramount in the Pieter Adam collection. From the silk chords to the metal housing for each fitting, a Pieter Adam piece is assembled with scrutiny and passion. A showpiece in your interior radiating international splendour.





## ROSEDALE

A real Pieter Adam piece plays with different materials. The elegance and lightness of the blown glass contradict the shape of the metal which gives a Rosedale piece its distinctive and playful quality thus ensuring its own identity and recognition. The glass beautifully absorbs any colour and the combination of materials engages the light in a very unique way.

The Rosedale series encompasses transparency and exclusivity offering plenty possibilities when you need a real glamour piece. Whether placed in a five-star hotel lobby or in your residence, these eye catchers complement any interior.

Timeless and with a great adaptability, a Rosedale piece easily integrates in its environment while leaving a great impression through its stylish appearance.

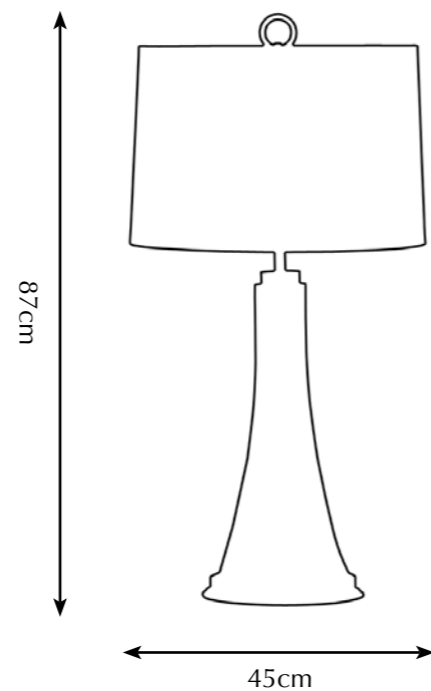

Itemnr: **PA 821**  
Model: Rosedale table-lamp  
Material: Casted brass/Blown Glass  
Shade: 8214 Saffron Black  
Sockets: 2x E27 max. 60 Watt  
Finishes: -Dutch Silver  
          **-Canadian Gold**  
          -Smoked Brass

\* For images of the other finishes visit our website.

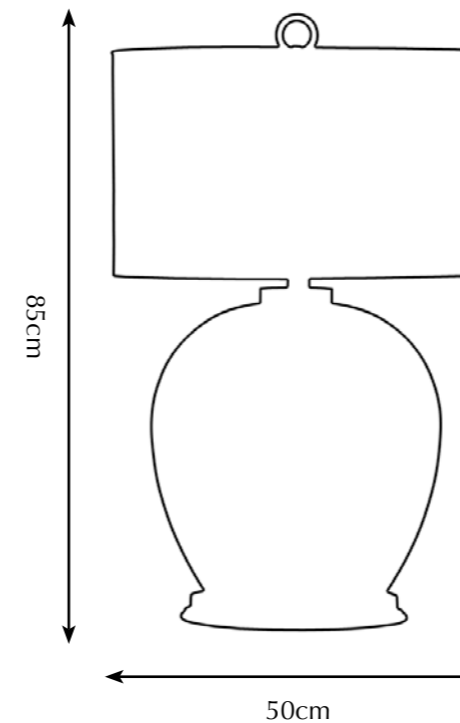

Itemnr: **PA 822**  
Model: Rosedale table-lamp big  
Material: Casted brass/Blown Glass  
Shade: 5305 Pitch Black Silk  
Sockets: 2x E27 max. 60 Watt  
Finishes: -Dutch Silver  
          -Canadian Gold  
          -Smoked Brass  
          **-Rose Gold**

\* For images of the other finishes visit our website.



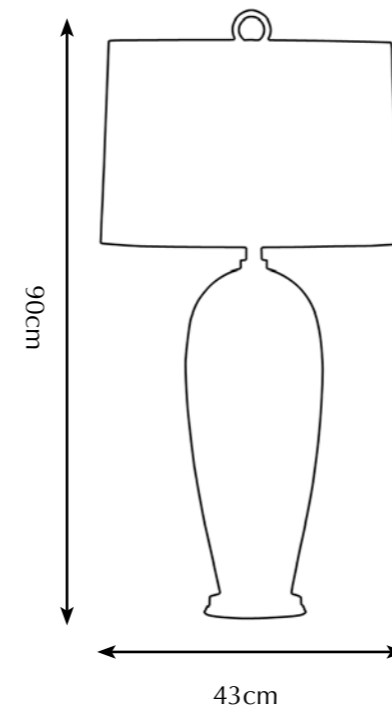

- Itemnr: **PA 823**  
Model: Rosedale table-lamp  
Material: Casted brass/Blown Glass  
Shade: 5301 Stony Ground Linen  
Sockets: 2x E27 max. 60 Watt  
Finishes: **-Dutch Silver**  
          -Canadian Gold  
          -Smoked Brass  
          -Rose Gold

\* For images of the other finishes visit our website.



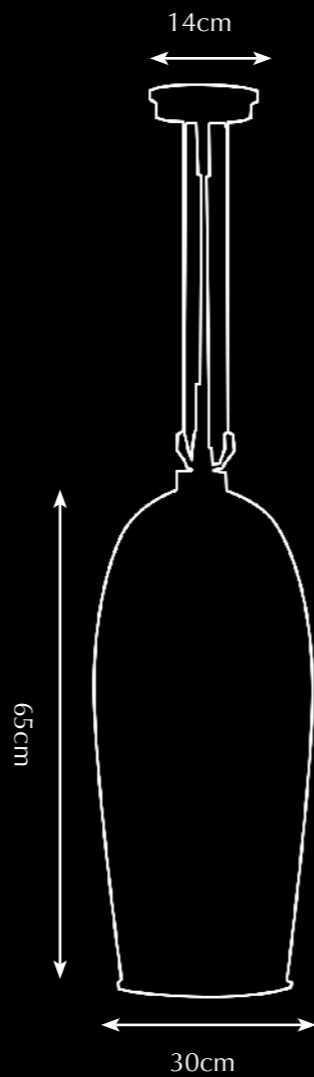

Itemnr: **PA 825**  
 Model: Rosedale hanging lamp long  
 Material: Casted brass/Blown glass  
 Socket: E27 max. 60Watt  
 Finishes: **-Dutch Silver**  
 -Canadian Gold  
 -Rose Gold

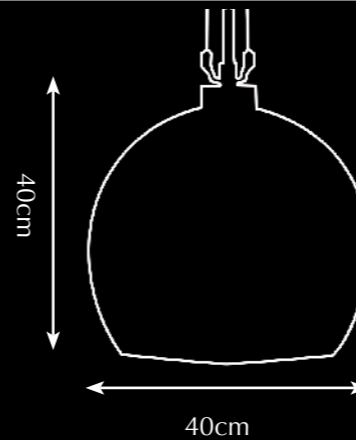

Itemnr: **PA 824**  
 Model: Rosedale hanging lamp round  
 Material: Casted brass/Blown glass  
 Socket: E27 max. 60Watt  
 Finishes: **-Dutch Silver**  
**-Canadian Gold**  
 -Rose Gold

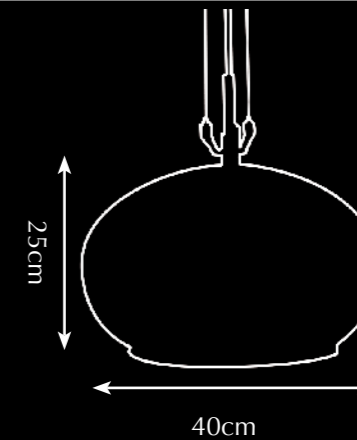

Itemnr: **PA 826**  
 Model: Rosedale hanging lamp oval  
 Material: Casted brass/Blown glass  
 Socket: E27 max. 60Watt  
 Finishes: **-Dutch Silver**  
 -Canadian Gold  
**-Rose Gold**





## BRONX

The Bronx series exemplifies lighting with an international radiance. The Pieter Adam logo, circular interconnecting links, returns frequently within these series. These rings are very recognizable and give this series its own identity.

Inspiration for this series was found in refined traditional workmanship on the one hand and the dynamic development of the new era on the other resulting in an unpretentious design employing geometrical patterns and clean lines.

The Bronx style resembles the Art Deco looks. In the late 19th and early 20th century, the Art Deco workmanship was highly valued and appreciated. Also for this series, a lot of patience and expertise is demanded from our bronze founders. A laborious process, recurring in for example the separate moulding of each ring, which is subsequently melted onto the connecting piece. Polished, silver/gold plated and varnished, each piece is made with the utmost attention to perfection.

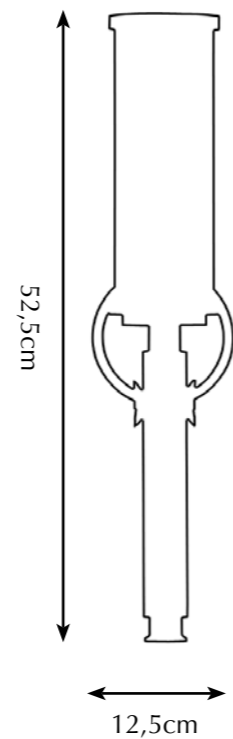

Itemnr: **PA 801**  
Model: Bronx wall-sconce  
Material: Casted brass  
Sockets: E27 max. 60 Watt  
Finishes: **-Dutch Silver**  
-Canadian Gold  
-Smoked Brass  
-Retro Blond

\* For images of the other finishes visit our website.

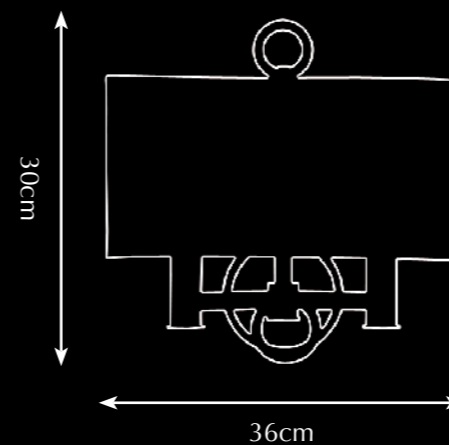

Itemnr: **PA 802**  
Model: Bronx wall-sconce  
Material: Casted brass  
Shade: 8214 Saffron Black  
Sockets: 2x E14 max. 60 Watt  
Finishes: **-Dutch Silver**  
**-Canadian Gold**  
-Smoked Brass  
-Retro Blond

\* For images of the other finishes visit our website.



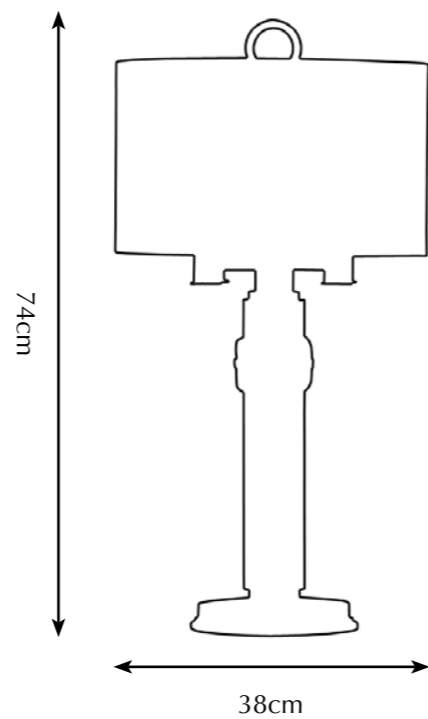

Itemnr: **PA 809**  
Model: Bronx table-lamp  
Material: Casted brass  
Shade: D186 Black Gold Silk  
Sockets: 4x E14 max. 40 Watt  
Finishes: -Dutch Silver  
          **-Canadian Gold**  
          -Smoked Brass  
          -Retro Blond

\* For images of the other finishes visit our website.

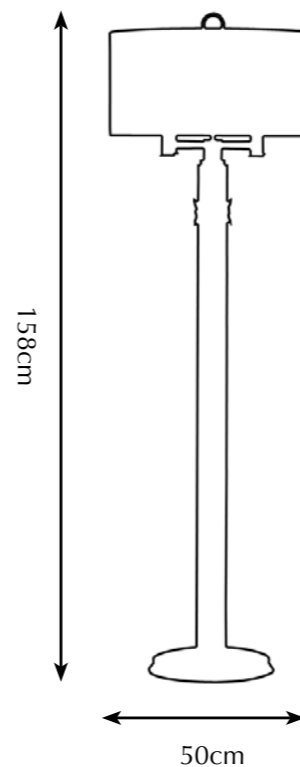

Itemnr: **PA 804**  
Model: Bronx floor-lamp  
Material: Casted brass  
Shade: 5301 Stony Ground Linen  
Sockets: 4x E14 max. 40 Watt  
Finishes: **-Dutch Silver**  
          -Canadian Gold  
          -Smoked Brass  
          -Retro Blond

\* For images of the other finishes visit our website.



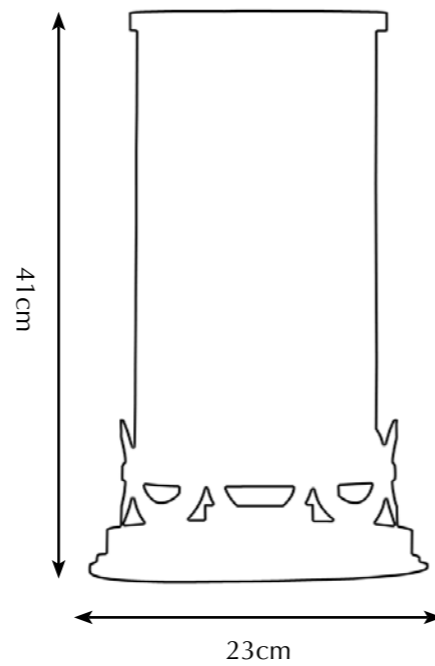

Itemnr: **PA 803**  
Model: Bronx hurricane  
Material: Casted brass  
Finishes: **-Dutch Silver**  
          -Canadian Gold  
          -Smoked Brass  
          -Retro Blond

\* For images of the other finishes visit our website.



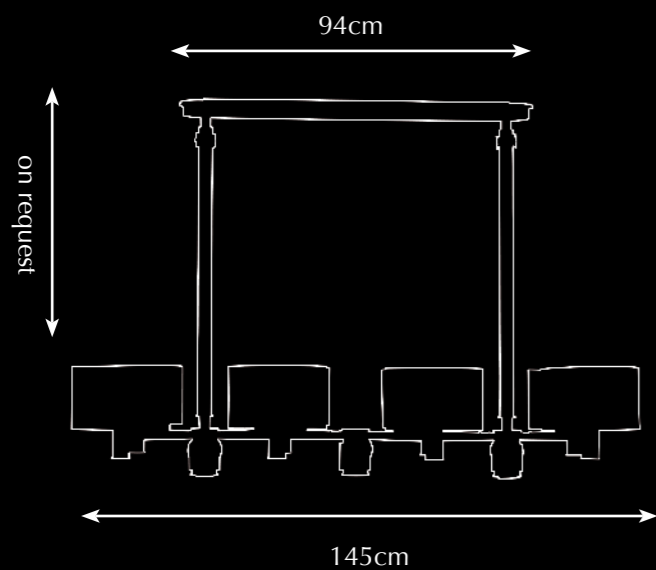

Itemnr: **PA 830**  
Model: Pendant Bronx 8 shades  
Material: Casted Brass  
Shade: 5301 Stony Ground Linen  
Sockets: 8x E27 max. 60 Watt,  
2x GU 10 220V halogen  
spotlight max. 50 Watt  
Finishes: **-Dutch Silver**  
-Canadian Gold  
-Smoked Brass  
-Retro Blond  
-Rose Gold

\* For images of the other finishes visit our website.

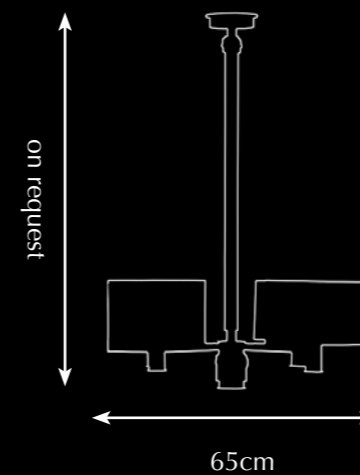

Itemnr: **PA 831**  
Model: Pendant Bronx 4 shades  
Material: Casted Brass  
Shade: 8273 Cracked Glossy Black  
Sockets: 4x E27 max. 60 Watt,  
1x GU 10 220V halogen  
spotlight max. 50 Watt  
Finishes: **-Dutch Silver**  
**-Canadian Gold**  
-Smoked Brass  
-Retro Blond  
-Rose Gold

\* For images of the other finishes visit our website.



## ODEON

The Odeon collection uses the elegant diabolo shape as its starting point. The stacking and flared shape of this series gives it a sharp appearance with a hint of retro. The Pieter Adam rings also return here as an important decorative element as well as a trademark. With its strong contour, an Odeon piece represents sophisticated, refined and characteristic design without too much adornment.

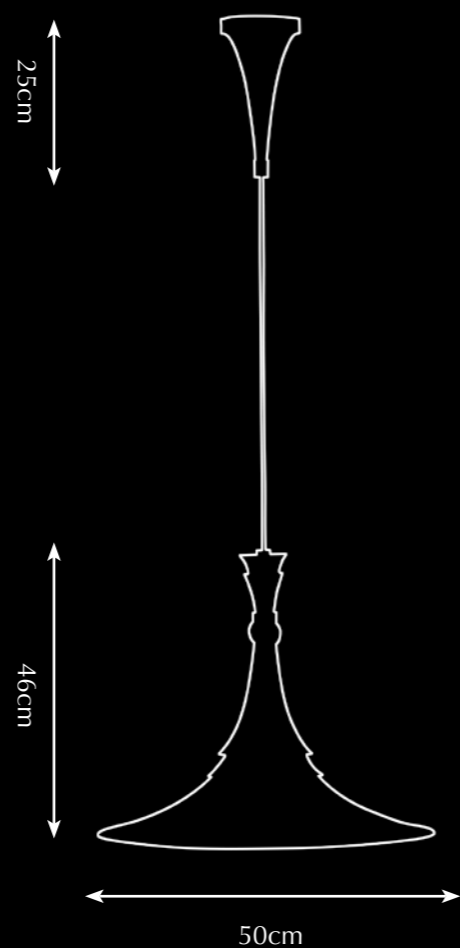

Itemnr: **PA 812**  
Model: Odeon hanging-lamp  
Material: Casted brass  
Sockets: E27 max. 100 Watt  
Finishes: **-Canadian Gold**  
-Smoked Brass  
-Retro Blond  
-Dutch Silver

\* For images of the other finishes visit our website.

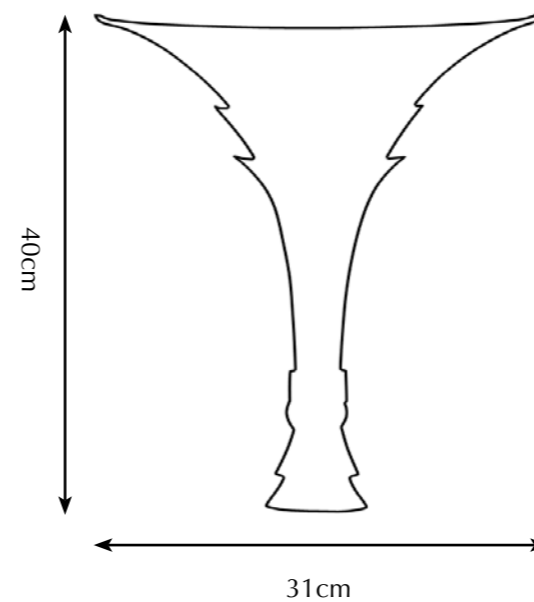

Itemnr: **PA 814**  
Model: Odeon wall-sconce  
Material: Casted brass  
Sockets: E14 max. 100 Watt  
Finishes: **-Dutch Silver**  
-Canadian Gold  
-Smoked Brass  
-Retro Blond

\* For images of the other finishes visit our website.



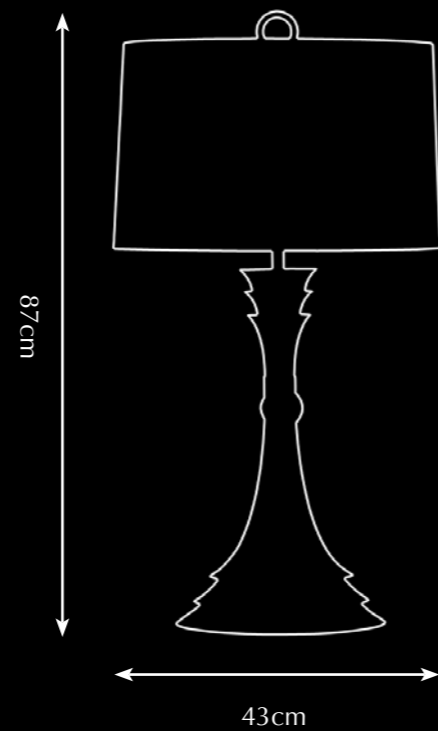

Itemnr: **PA 815**  
Model: Odeon table-lamp  
Material: Casted brass  
Shade: D274 Pure Linen  
Sockets: 2x E27 max. 60 Watt  
Finishes: -Dutch Silver  
-Canadian Gold  
-Smoked Brass  
**-Retro Blond**

\* For images of the other finishes visit our website.

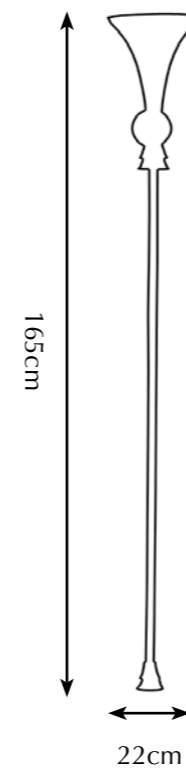

Itemnr: **PA 816**  
Model: Odeon wall torch  
Material: Casted brass  
Sockets: E14 max. 40 Watt  
Finishes: **-Dutch Silver**  
-Canadian Gold  
-Smoked Brass

\* For images of the other finishes visit our website.





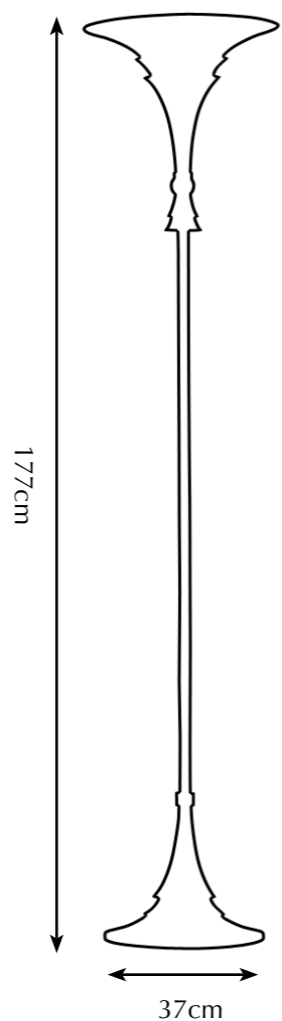
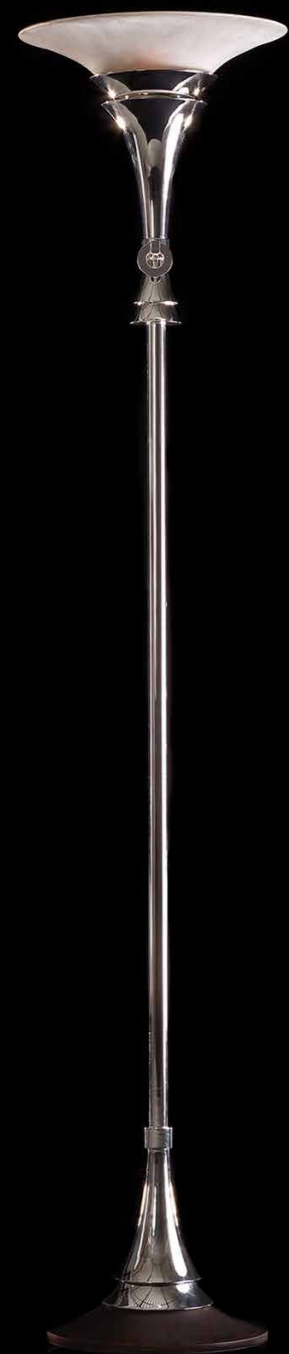

Itemnr: **PA 817**  
Model: Odeon floor-lamp  
Material: Casted brass  
Sockets: E27 max. 100 Watt  
Finishes: **-Dutch Silver**  
-Canadian Gold  
-Retro Blond

\* For images of the other finishes visit our website.

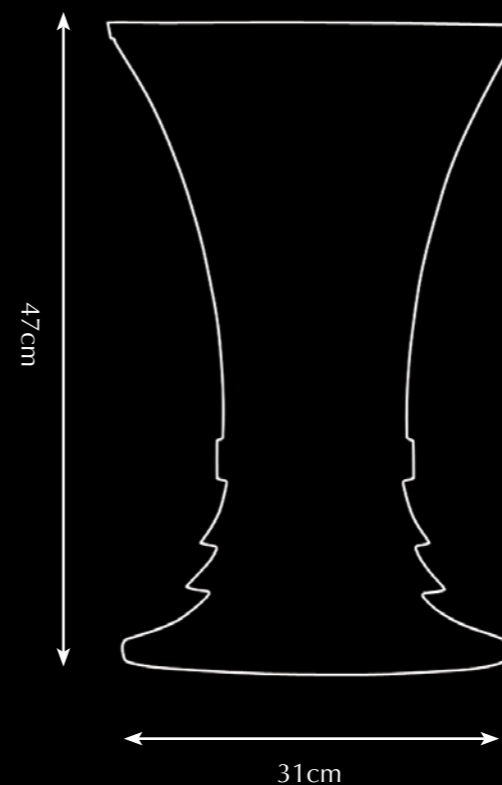

Itemnr: **PA 818**  
Model: Odeon hurricane  
Material: Casted brass  
Finishes: **-Canadian Gold**  
-Smoked Brass  
**-Retro Blond**

\* For images of the other finishes visit our website.



PIETER ADAM  
LUSTROGRAD BY  
PIETER ADAM





## MELTING PARIS

The Melting Paris series combines nature's radiance with organic shapes in a contemporary style by employing a raw surface of bronze. Recognizable shapes are restyled to achieve their own look.

In contrast with today's mass production, Pieter Adam wants his designs to show his personal touch and signature. This is clearly visible in the Melting Paris series where each piece is handcrafted in wax literally showing the artist's finger prints. When looking at a Melting piece one can see the organic, unrestricted shape; nothing is straight or smooth. These pieces are characteristic of detail and achievement. The possibilities bronze casting offers are being employed in all its facets.

The freedom of creativity and inspiration is ultimately found in creating something by just using your hands. It is the purest way of designing. Away from all mass produced items and searching for the authentic craftsmanship only traditional craftsmen can achieve. Sustainable, with love for his craft and the end product, a Melting Paris piece truly gives a peek in the artist's head.

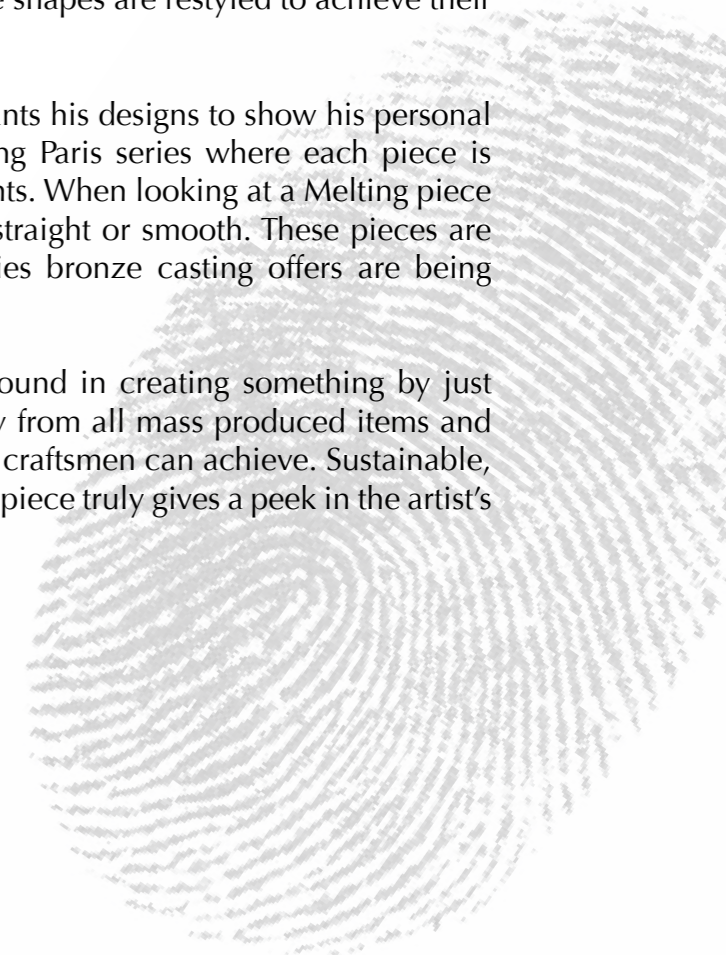

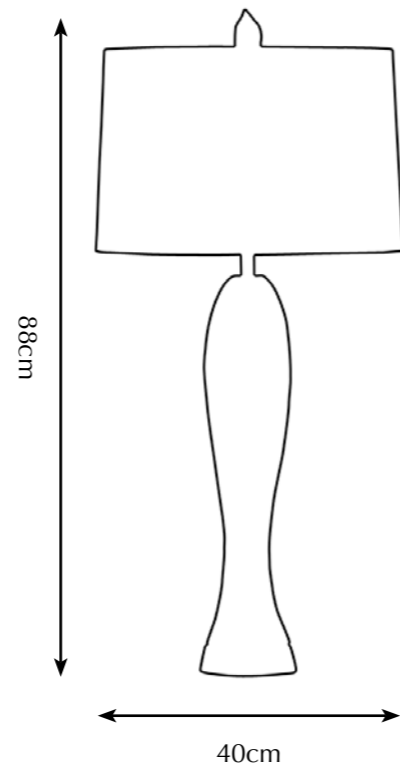

Itemnr: **PA 847**  
Model: Melting Paris table-lamp  
Material: Casted brass  
Shade: 5300 Forest Linen  
Sockets: 2x E27 max. 60 Watt  
Finishes: -Dutch Silver  
-Canadian Gold  
**-Smoked Brass**  
-Rose Gold

\* For images of the other finishes visit our website.

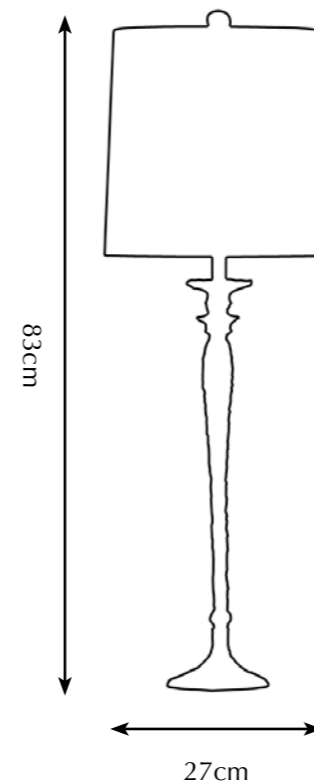

Itemnr: **PA 849**  
Model: Melting Paris table-lamp  
Material: Casted brass  
Shade: 8259 Ivory Velvet  
Sockets: 2x E14 max. 40 Watt  
Finishes: **-Dutch Silver**  
-Canadian Gold  
-Smoked Brass  
-Rose Gold

\* For images of the other finishes visit our website.



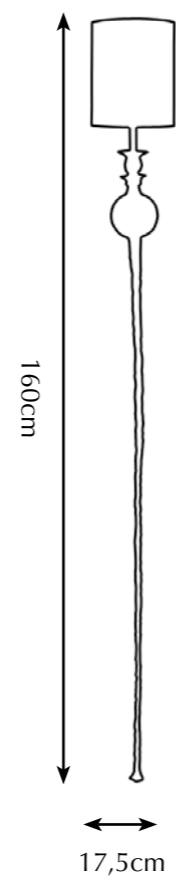

Itemnr: **PA 856**  
Model: Melting Paris wall-torch long  
Material: Casted brass  
Shade: 7051 Seashell Silk  
Sockets: E27 max. 60 Watt  
Finishes: -Dutch Silver  
          **-Canadian Gold**  
          -Smoked Brass  
          -Rose Gold

\* For images of the other finishes visit our website.

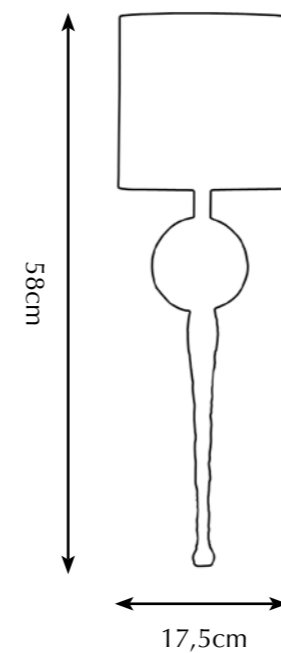

Itemnr: **PA 855**  
Model: Melting Paris wall-torch  
Material: Casted brass  
Shade: 5301 Stony ground Linen  
Sockets: E27 max. 40 Watt  
Finishes: **-Dutch Silver**  
          -Canadian Gold  
          -Smoked Brass  
          -Rose Gold

\* For images of the other finishes visit our website.



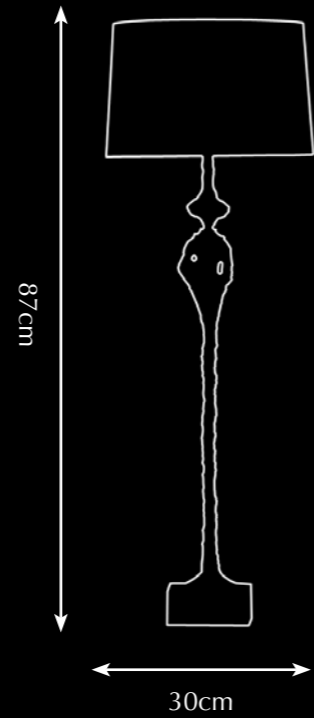

Itemnr: **PA 851**  
Model: Melting Paris Sunday afternoon man  
Material: Casted brass  
Shade: 8261 Burnished Gold Velvet  
Sockets: 2x E14 max. 40 Watt  
Finishes: -Dutch Silver  
          **-Canadian Gold**  
          -Smoked Brass

\* For images of the other finishes visit our website.

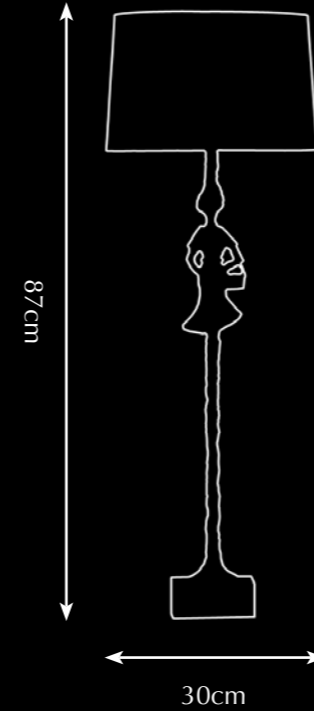

Itemnr: **PA 850**  
Model: Melting Paris Sunday afternoon woman  
Material: Casted brass  
Shade: 8261 Burnished Gold Velvet  
Sockets: 2x E14 max. 40 Watt  
Finishes: -Dutch Silver  
          **-Canadian Gold**  
          -Smoked Brass

\* For images of the other finishes visit our website.



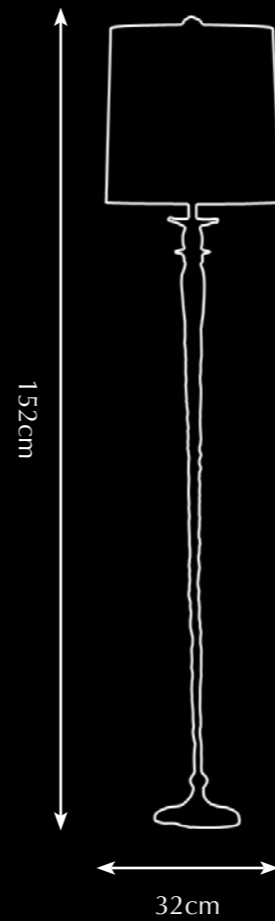

Itemnr: **PA 845**  
Model: Melting Paris floor-lamp  
Material: Casted brass  
Shade: 8230 Black Leather  
Sockets: 2x E14 max. 40 Watt  
Finishes: -Dutch Silver  
          -Canadian Gold  
          -Smoked Brass  
          **-Rose Gold**

\* For images of the other finishes visit our website.





## MELTING AMSTERDAM

Our capital Amsterdam has a rich history and has been a cultural melting pot for many centuries. As a result, the city has its own identity with freedom and individuality being its main traits. This is also true of the new collection designed by Pieter Adam™. The copper-tinted chandeliers of the Golden Age were a source of inspiration for this unique line of lighting fixtures. Tradition and craftsmanship are applied in a contemporary way bringing the past, present and future together. Materials such as gold, silver, Murano glass, silk and brass casted in sand are used for their superior quality. The Dutch design of Pieter Adam™ supplies the originality.



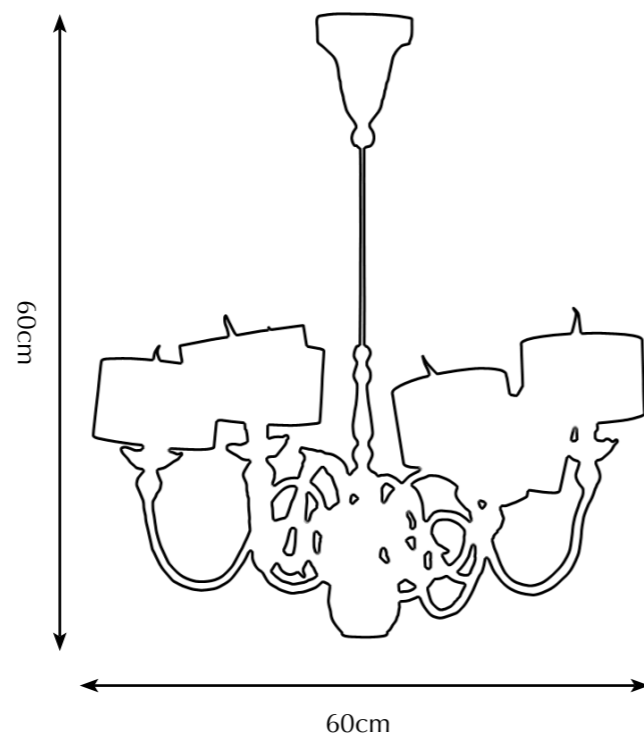

Itemnr: **PA 860**  
Model: Melting Amsterdam chandelier  
Material: Casted brass  
Shade: 8259 Ivory Velvet  
Sockets: G4 12V max. 10 Watt halogen,  
Spotlight max. 30 Watt  
Finishes: **-Dutch Silver**  
**-Canadian Gold**

\* For images of the other finishes visit our website.

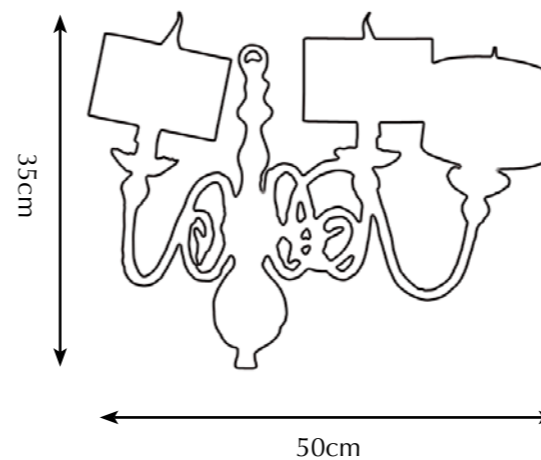

Itemnr: **PA 861**  
Model: Melting Amsterdam wall sconce  
Material: Casted brass  
Shade: 5305 Pitch Black Silk  
Sockets: G4 12V max. 10 Watt halogen  
Finishes: **-Dutch Silver**  
**-Canadian Gold**

\* For images of the other finishes visit our website.



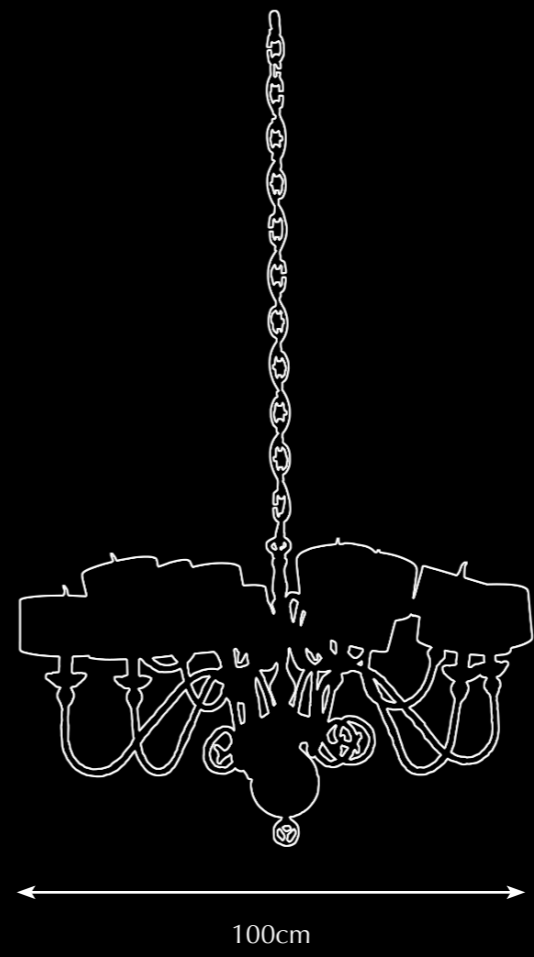

- Itemnr: **PA 865**
- Model: Melting Amsterdam chandelier XL
- Material: Casted brass
- Shade: 8259 Ivory Velvet
- Sockets: 12x G9 230V max. 25Watt
- Finishes: **-Dutch Silver**  
-Canadian Gold  
-Rose Gold

\* For images of the other finishes visit our website.

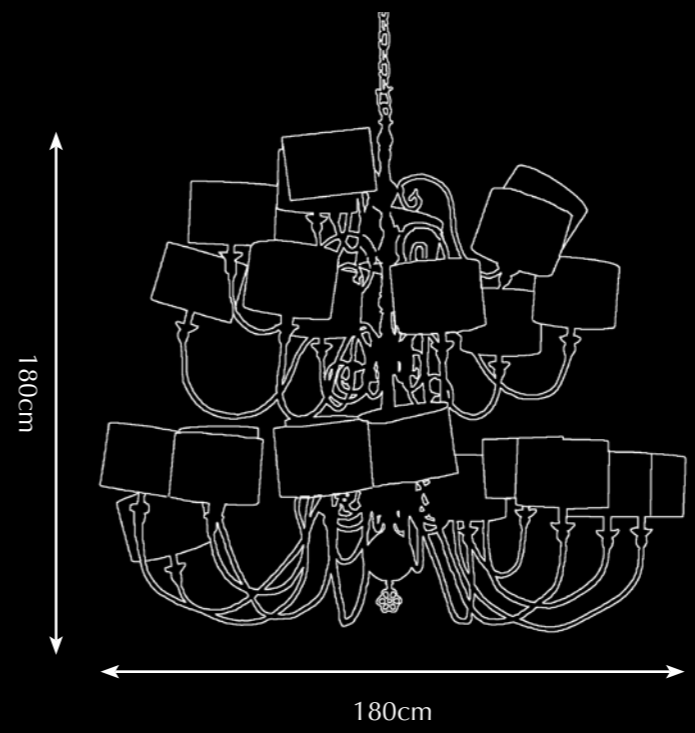

Itemnr: **PA 866**  
Model: Melting Amsterdam hanging lamp XXL  
Material: Casted Brass  
Shades: on request  
Sockets: 24x E27 max. 60 Watt  
Finishes: **-Dutch Silver**  
              **-Canadian Gold**

\* For images of the other finishes visit our website.





## TWIGGY

Pieter Adam's Twiggy line comprehends contemporary design and sustainability. Twiggy is a collection based on nature's purest grace. Inspiration was found in the organic, capricious shaping of twigs. Pursuing nature's strength in growing strong and solid with its unequalled, beautiful and characteristic appearance was serving as the main source of inspiration for the designer. Fair materials like brass and glass emphasize the sustainable nature of this collection. Organic shapes casted in brass and crafted with the utmost attention to detail combined with mouthblown glass providing a subtle reflection of the halogen light. Finishes like silver and gold give this lighting series its specific and exclusive radiation.

Look, feel and admire: enjoy nature's beauty where no twigs are alike.

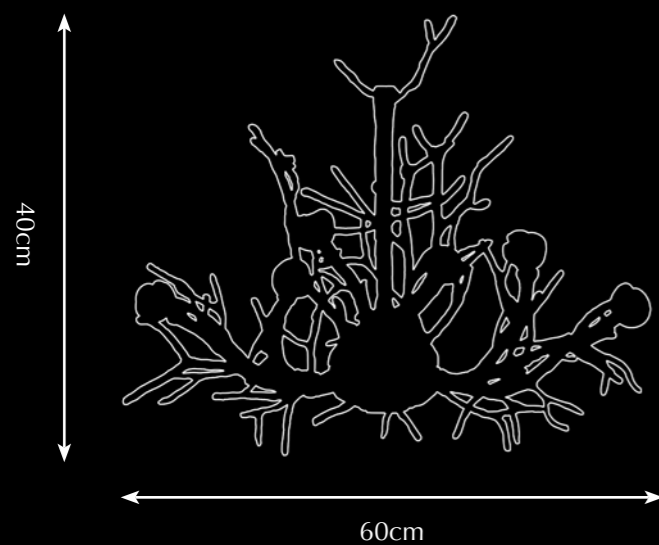

Itemnr: **PA 870**  
Model: Twiggy hanging lamp small  
Material: Casted brass  
Sockets: 6x G4 12V max. 5 Watt  
halogen spot max. 30 Watt  
Finishes: -Dutch Silver  
-**Canadian Gold**  
-Smoked Brass

\* For images of the other finishes visit our website.

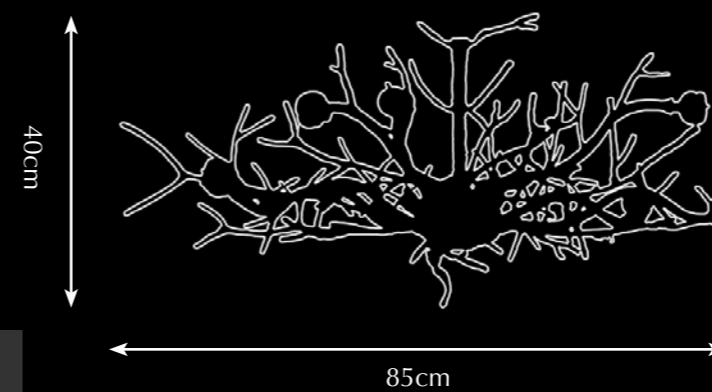

Itemnr: **PA 871**  
Model: Twiggy hanging lamp medium  
Material: Casted brass  
Sockets: 9x G4 12V max. 5 Watt  
halogen spot max. 30 Watt  
Finishes: -**Dutch Silver**  
-Canadian Gold  
-Smoked Brass

\* For images of the other finishes visit our website.

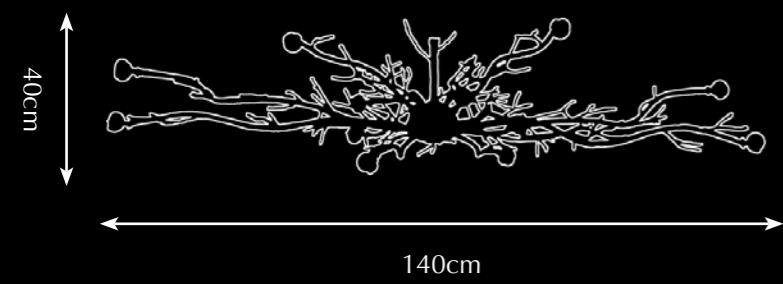
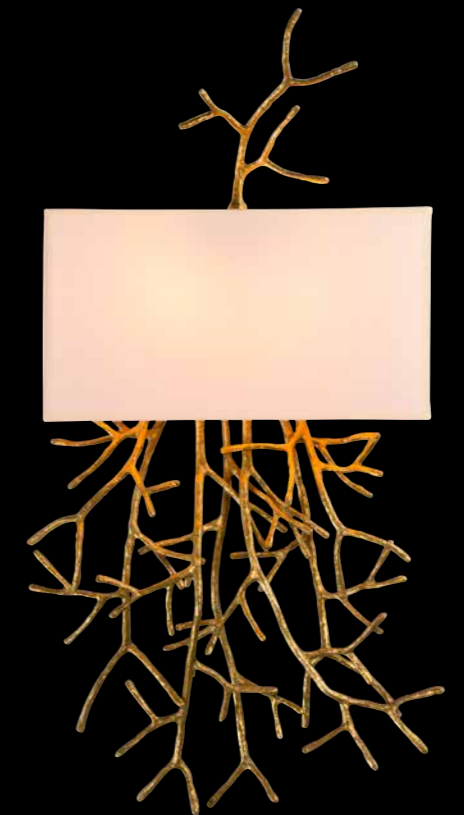

Itemnr: **PA 872**  
 Model: Twiggy hanging lamp large  
 Material: Casted brass  
 Sockets: 12x G4 12V max. 5 Watt  
 halogen spot max. 30 Watt  
 Finishes: **-Dutch Silver**  
 -Canadian Gold  
 -Smoked Brass

\* For images of the other finishes visit our website.

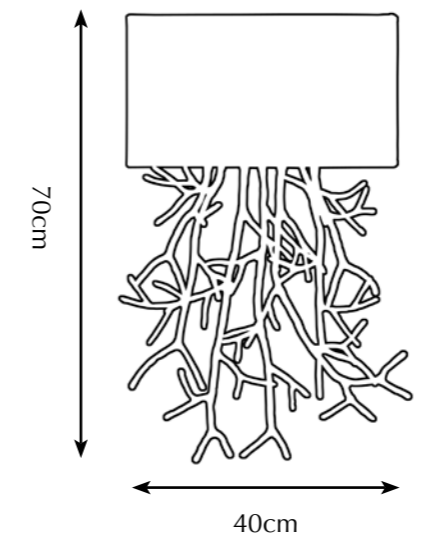

Itemnr: **PA 875**  
 Model: Twiggy wall-sconce  
 Material: Casted brass  
 Shade: 8111 Champagne Silk  
 Sockets: 2x E14 max. 40Watt  
 Finishes: **-Dutch Silver**  
**-Canadian Gold**  
 -Smoked Brass

\* For images of the other finishes visit our website.

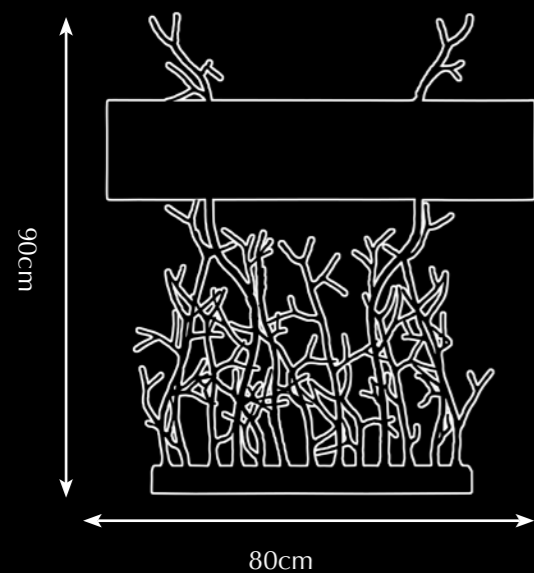
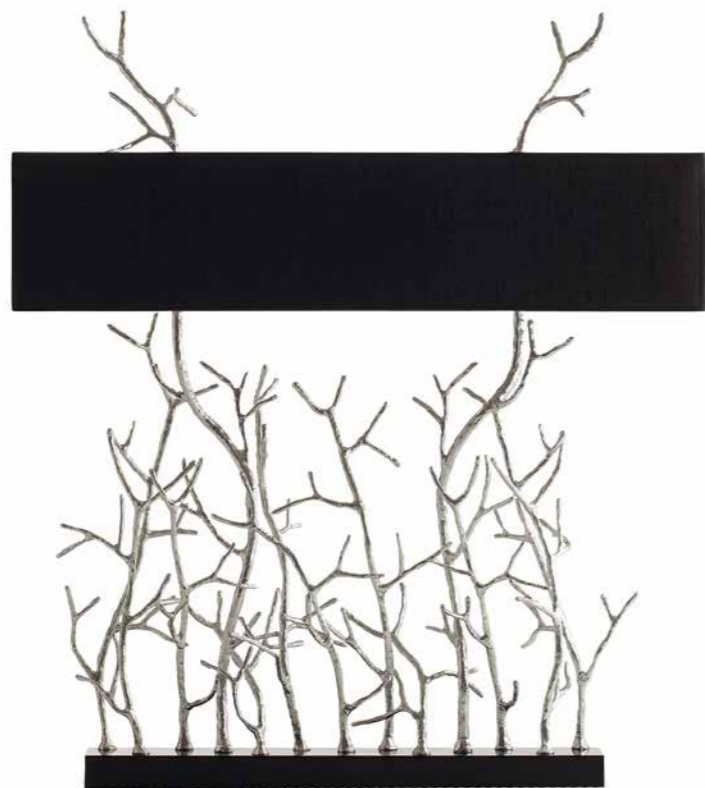

Itemnr: **PA 873**  
Model: Twigg table lamp XL  
Material: Casted brass  
Shade: 5306 Pitch Black Silk  
Sockets: 4x E14 max. 40 Watt  
Finish: **-Dutch Silver**  
-Canadian Gold  
-Smoked Brass

\* For images of the other finishes visit our website.

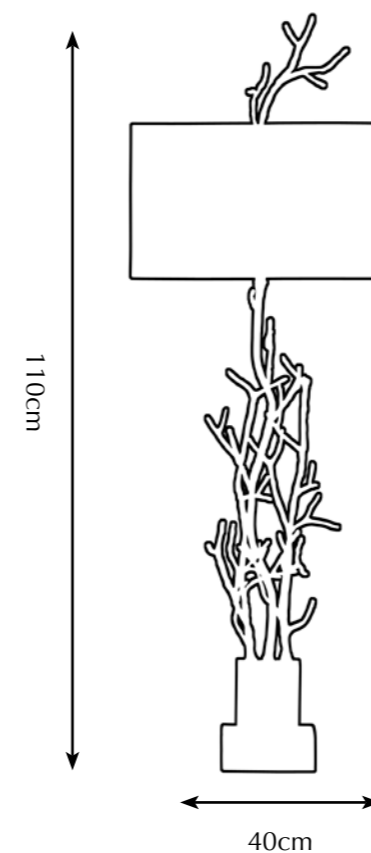

Itemnr: **PA 874**  
Model: Twigg table lamp high  
Material: Casted brass  
Shade: 8215 Ivory Smooth Linen  
Sockets: 2x E14 max. 40 Watt  
Finish: **-Dutch Silver**  
-Canadian Gold  
-Smoked Brass

\* For images of the other finishes visit our website.



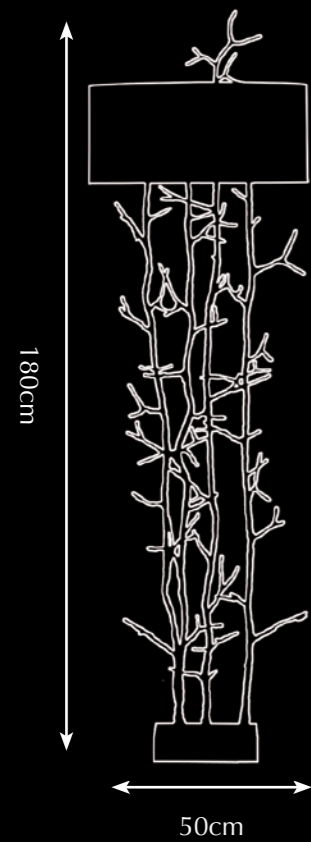

Itemnr: **PA 876**  
 Model: Twiggly floor lamp  
 Material: Casted brass  
 Shade: 5305 Pitch Black Silk  
 Sockets: 2x E14 max. 40Watt  
 Finish: -Dutch Silver  
       **-Canadian Gold**  
       -Smoked Brass

\* For images of the other finishes visit our website.

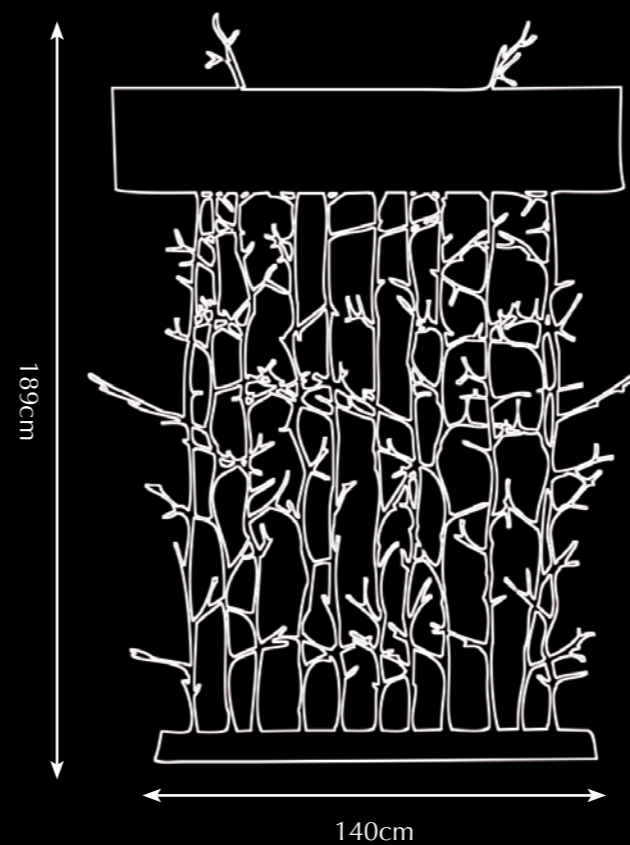
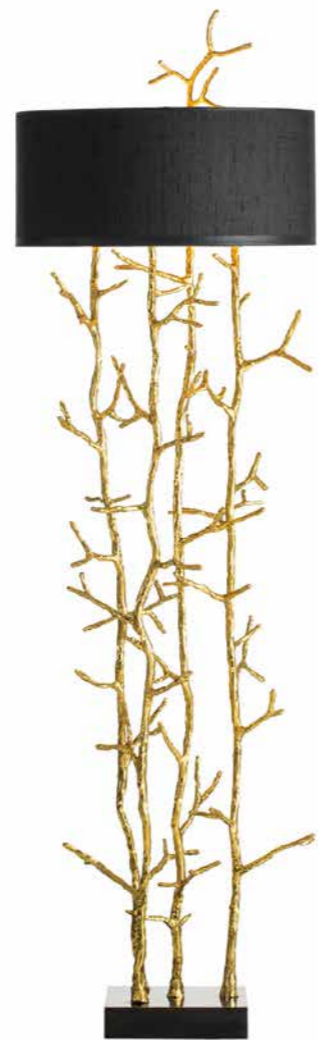

Itemnr: **PA 877**  
 Model: Twiggly floor lamp XL  
 Material: Casted Brass  
 Shades: 8111 Champagne Silk  
 Sockets: 4x E14 max. 40Watt  
 Finishes: -Dutch Silver  
           **-Canadian Gold**  
           -Smoked Brass

\* For images of the other finishes visit our website.







## LE SOLEIL

Pieter Adam's Le Soleil design encompasses the shape and warm shine of a radiant sun. Nature's beauty has always been a main source of inspiration for the Pieter Adam collection and this was no different for the Le Soleil design. A natural shape made of bronze, with a closed inner circle and an outer circle scattering rays of light. This sculpture has a very pleasant and warm appearance. It can be adjusted to the wall, as well as to the ceiling, ensuring an unique diffusion of light. Le Soleil is available in four sizes and in the finishes bronze, silver and gold. Contemporary and subtle design are characteristic for the Pieter Adam collection and for this, Le Soleil is no exception.

# PIETER ADAM

## CONTEMPORARY DESIGN

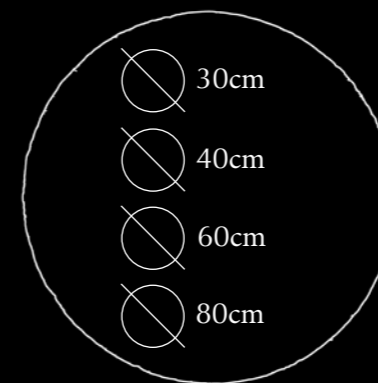

Itemnr: **PA 200 - 30cm**  
**PA 201 - 40cm**  
**PA 202 - 60cm**  
**PA 203 - 80cm**  
Model: Le Soleil wall lamp  
Material: Casted brass  
Sockets: 6x max. 10 Watt G4  
Finishes: -Vintage Silver  
-Vintage Gold  
-Smoked brass

\* For images of the other finishes visit our website.



## ORGANIC ATOMIC

As its name indicates, the design of Organic Atomic is reminiscent of the smallest particle that an element can be reduced to. This lighting object resembles the organic both systematic composition of everything we see around us. Based on the organic work of art, the spheres are connected in a way that the whole forms an impressive and striking piece of lighting. The Murano glasses with silver leaf are specially blown and designed for this new Pieter Adam series. Sculpted by hand and casted in brass, the connecting pieces can be linked in many ways providing endless possibilities for customization. This leaves lighting architects the opportunity to give their own interpretation to this design and fit it perfectly into their lighting projects.

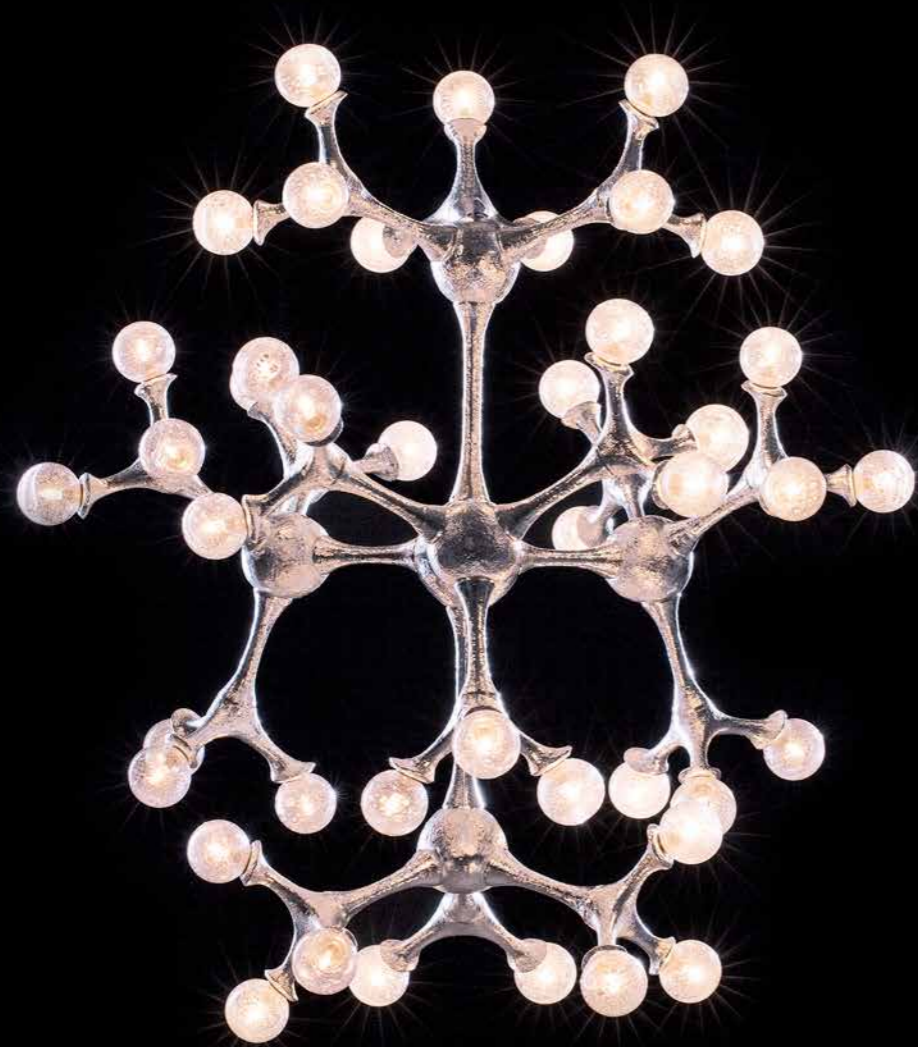

Itemnr: **PA 892**  
Model: Organic Atomic hanging lamp  
Sockets: 45x G4 LED  
Finish: **-Dutch Silver**  
-Canadian Gold  
Dimensions: L90xD80xH95cm

\* Custom sizes on request. For images of the other finishes visit our website.

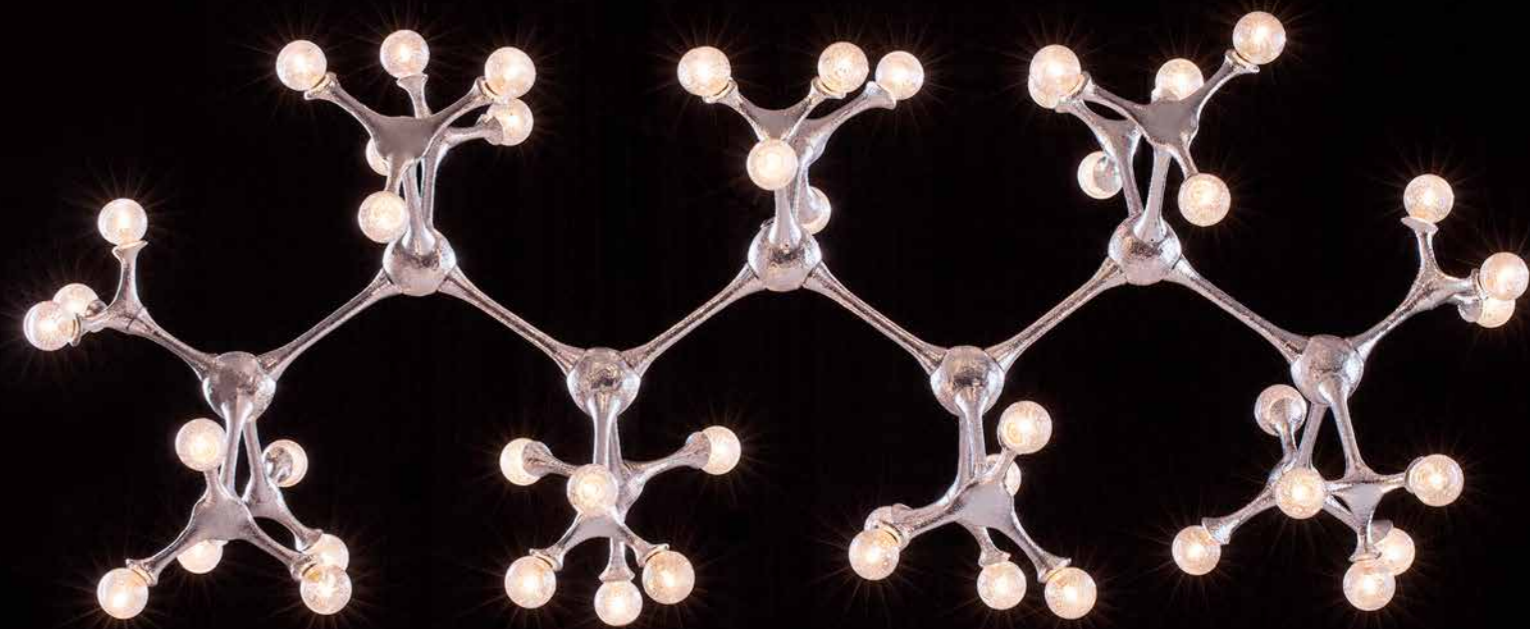

Itemnr: **PA 891**  
Model: Organic Atomic hanging lamp XL  
Sockets: 48x G4 LED  
Finish: **-Dutch Silver**  
-Canadian Gold  
Dimensions: L185xD70xH75cm

\* Custom sizes on request. For images of the other finishes visit our website.



Itemnr: **PA 894**  
Model: Organic Atomic hanging lamp round XL  
Sockets: 75x G4 LED  
Finish: **-Oxid silver**  
-Oxid green  
-Other finishes on request  
Dimensions: Ø120cm / Ø 80cm

\* Custom sizes on request. For images of the other finishes visit our website.



Itemnr: **PA 897**  
Model: Organic Atomic table lamp  
Sockets: 21x G4 LED  
Finish: **-Oxid silver**  
**-Oxid green**  
-Other finishes on request  
Dimensions: 65xH65cm

\* Custom sizes on request. For images of the other finishes visit our website.



Itemnr: **PA 893**  
Model: Organic Atomic wall sconce  
Sockets: 9x G4 LED  
Finish: **-Dutch Silver**  
          **-Canadian Gold**  
Dimensions: L50xD40xH55cm

\* Custom sizes on request. For images of the other finishes visit our website.





## MELTING FLOWERS

Flowers bring happiness, lightness and positive feelings. Inspired by his own garden, Pieter Adam began to mould these breath-taking products of nature in wax. With his designs, Pieter hopes to contribute to a joyful interior. For this, he most certainly succeeded with this Melting Flowers series existing of both hanging and wall lamps.

A flower is both beautiful on its own as well as bound together. This also accounts for the series of wall lights. One piece on itself is very decorative but filling a wall these objects are irresistible as well. All pieces are made by hand in brass and subsequently provided with a gold, rose gold or real silver layer.

The series of hanging lamps is very eye catching and perfectly suitable for a sophisticated setting. The flowers, in all their diversity, give these hanging lamps their appealing and lively appearance. The light is scattered in a unique and beautiful way, contributed by the thickness and silver spots of the glass bulbs. For these beautifully blown glasses, Pieter went to Italy where quality is still being made as he so much appreciates.

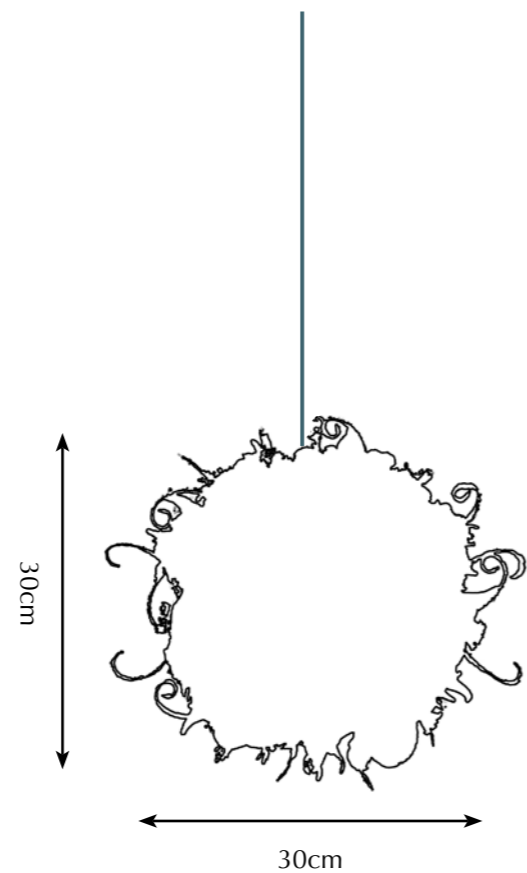

Itemnr: **PA 880**  
Model: Melting Flowers hanging lamp small  
Material: Casted Brass  
Sockets: 12x G4 Halogen max. 5 Watt  
Finishes: **-Gold base with silver flowers**  
-Black base with gold flowers  
-Gold/copper leaf and RAL colours for the base on request

\* For images of the other finishes visit our website.



Itemnr: **PA 881**  
Model: Melting Flowers hanging lamp medium  
Material: Casted Brass  
Sockets: 18x G4 Halogen max. 5 Watt  
Finishes: **-Gold base with silver flowers**  
-Black base with gold flowers  
**-Gold/copper leaf and RAL colours for the base on request**

\* For images of the other finishes visit our website.







STEP OUT OF THE SHADOW  
BY PIETER ADAM

  
LUSTRO GRAD  
ОПТОВЫЕ ПРОДАЖИ СВЕТИЛЬНИКОВ

THE ONLY ENEMY OF ART IS TASTE

THOMAS HOVING

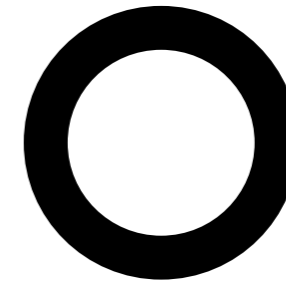

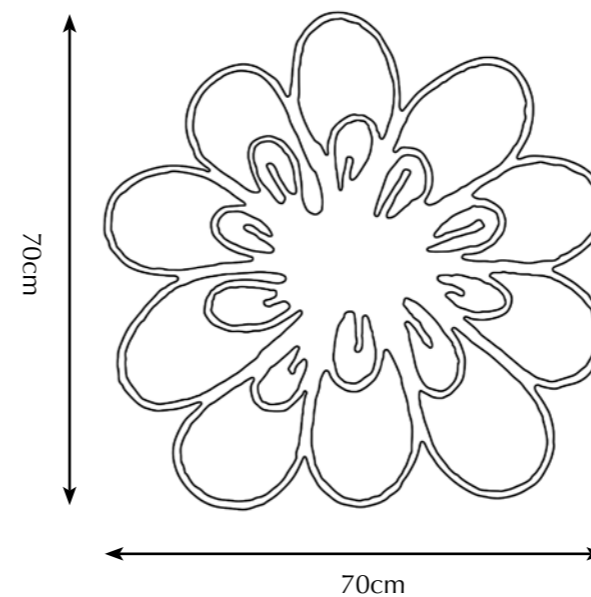
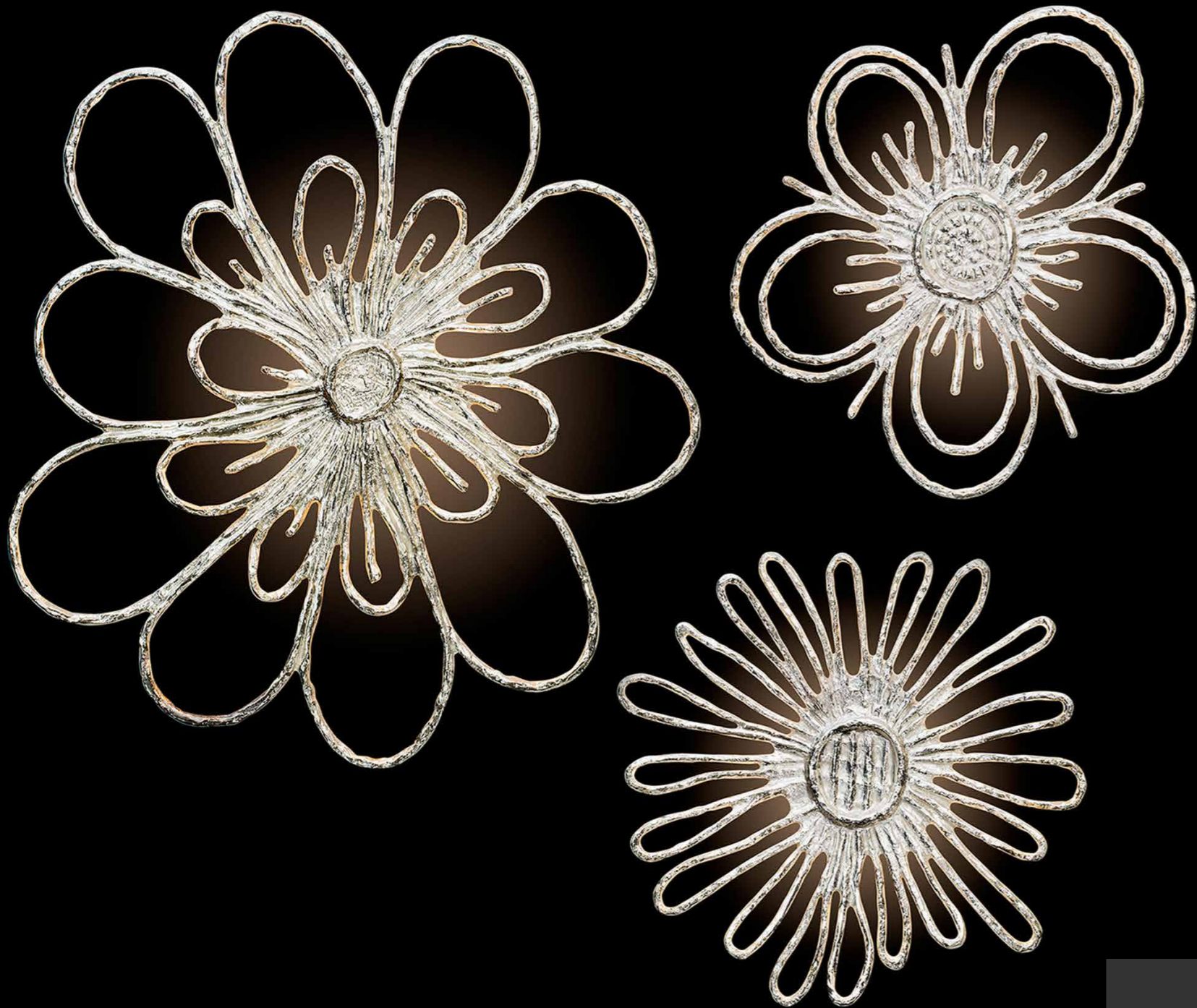

Itemnr: **PA 885**  
Model: Melting Flowers wall lamp Dahlia  
Material: Casted Brass  
Sockets: 6x G4 Halogen max. 10 Watt  
Finishes: -Dutch Silver  
          **-Canadian Gold**  
          -Rose Gold

\* For images of the other finishes visit our website.

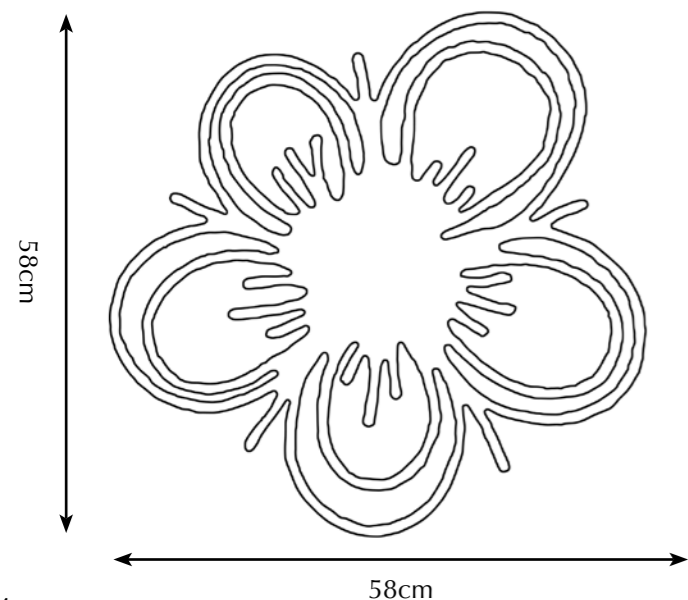

Itemnr: **PA 883**  
 Model: Melting Flowers wall lamp Blossom  
 Material: Casted Brass  
 Sockets: 6x G4 Halogen max. 10 Watt  
 Finishes: **-Dutch Silver**  
 -Canadian Gold  
 -Rose Gold

\* For images of the other finishes visit our website.

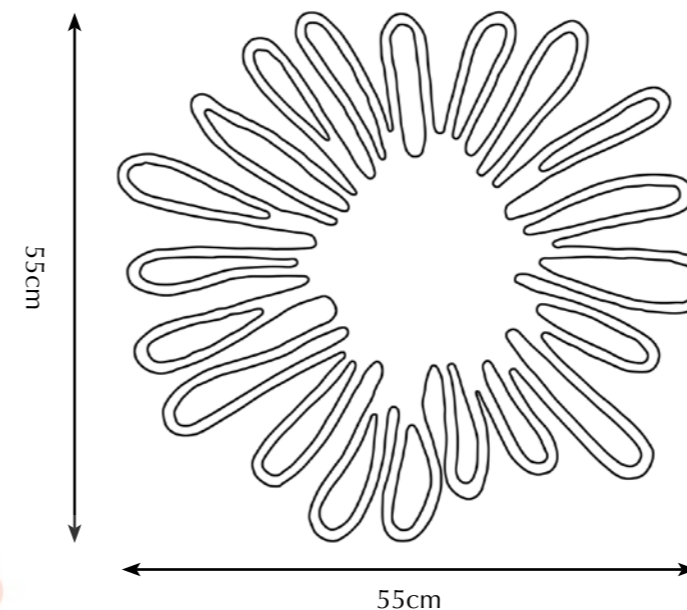

Itemnr: **PA 884**  
 Model: Melting Flowers wall lamp Daisy  
 Material: Casted Brass  
 Sockets: 6x G4 Halogen max. 10 Watt  
 Finishes: **-Dutch Silver**  
 -Canadian Gold  
 -Rose Gold

\* For images of the other finishes visit our website.



## MYSTERIOUS BAMBOO

Nature can work in mysterious ways, with its grace and curiosity serving as a great source of inspiration. In various Asian cultures bamboo is regarded a symbol for uprightness and tenacity. The plant is often endowed with traits as integrity, elegance, and optimism. The new Mysterious Bamboo series represents Pieter Adam's own interpretation of this noble plant, enriching it with a playfulness, joy and light-heartedness. The integrity and elegance in the detailing shows a great admiration of nature. An excellent choice for anyone looking to implement a botanical, mystic touch to their interior, perfectly fitting the present zeitgeist.

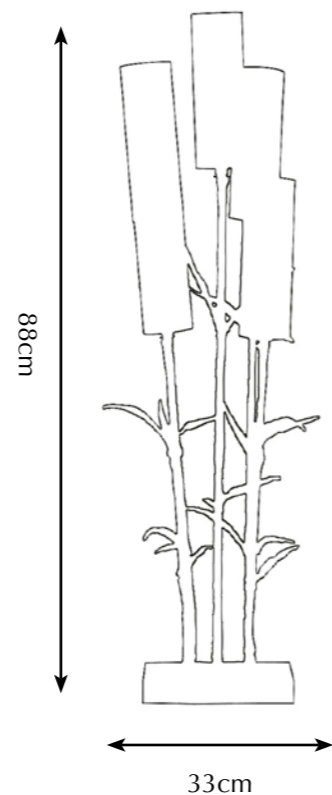

Itemnr: PA 901  
Model: Mysterious Bamboo table lamp  
Material: Casted brass  
Shade: 1141 Honey Glow Silk  
Sockets: 5x E14 max. 40Watt  
Finish: **-Natural Brass**  
          **-Dutch Silver**

\* For images of the other finishes visit our website.



Itemnr: PA 902  
Model: Mysterious Bamboo floor lamp S  
Material: Casted brass  
Shade: P109 White Lacquer  
Sockets: 3x E14 max. 40Watt  
Finish: **-Natural Brass**  
          **-Dutch Silver**

\* For images of the other finishes visit our website.



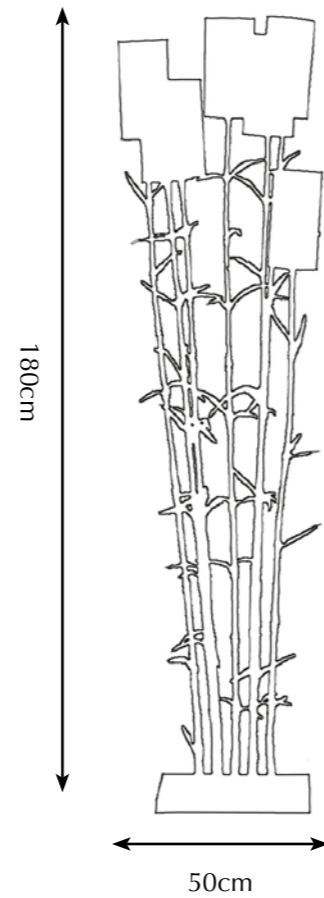

Itemnr: PA 903  
Model: Mysterious Bamboo floor lamp L  
Material: Casted brass  
Shade: 5305 Pitch Black Silk  
Sockets: 7x E14 max. 40Watt  
Finish: **-Natural Brass**  
**-Dutch Silver**

\* For images of the other finishes visit our website.

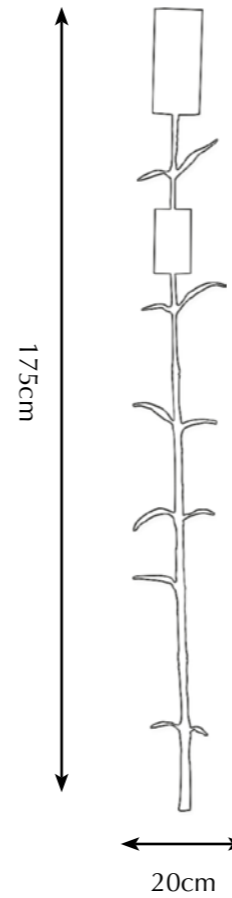

Itemnr: PA 904  
Model: Mysterious Bamboo wall lamp  
Material: Casted brass  
Shade: 5305 Pitch Black Silk  
Sockets: 1x E14 max. 40Watt  
Finish: **-Natural Brass**  
**-Dutch Silver**

\* For images of the other finishes visit our website.





## MELTING FEZ

With the Melting Fez series, Pieter Adam shows a new angle on combining varied authentic aesthetics. The sharp-edged curls, a Gothic decorative element, blend beautifully with the Moroccan feel of the lantern. The transparent, delicate fabric combined with the toughness and fickleness of the brass side lines, create a pleasant tension. The light sheltered in the stretched fabric adds a softness and warmth to the mystic sense this design exudes. Mysterious yet frivolous, this lush piece of characteristic lighting merges wonderfully in an ancient ambiance, complementing it with a contemporary twist.

This new series of lighting will soon be extended with wall lighting.

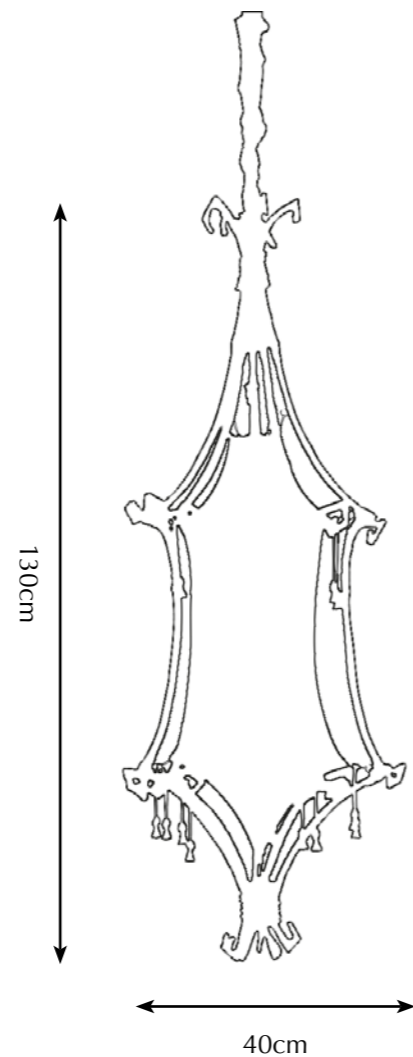

Itemnr: PA 501  
Model: Melting Fez hanging lamp  
Material: Casted brass  
Sockets: 1x E27 max. 60Watt  
Finish: -**Canadian Gold**  
-Dark Bronze  
-Dutch Silver

\* Matching wall sconce coming soon.  
For images of the other finishes visit our website.







## MELTING FLORENCE

Melting Florence is Pieter Adam's first series of lighting that can be used both indoors as well as outdoors. The series consist of lanterns with a distinctive twist. The history of lanterns is long standing. Italian lanterns were Pieter's source of inspiration for designing his own version of this centuries-old form of light. As usual, he shows a completely own silhouette corresponding his language of form and shape. The distorted lines and the surprising organic shaping create a completely new interpretation of an ancient type of lighting.

Pieter Adam hopes you will enjoy these objects as much as he enjoyed making them. Fantasy does not know any boundaries.

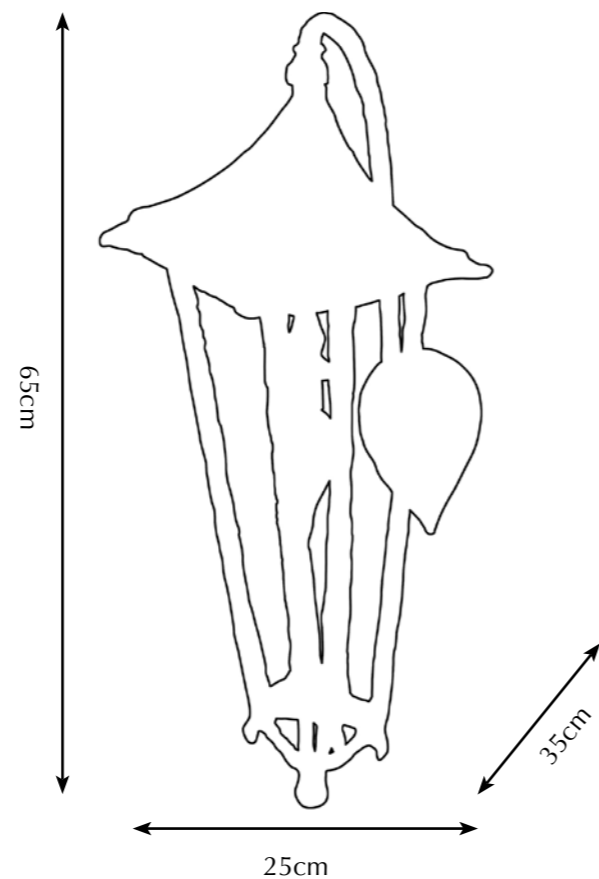

Itemnr: **PA 232 – PA 233**  
Model: Melting Florence wall lantern medium  
Material: Casted Brass  
Sockets: G9 max. 25 Watt  
Finishes: Dutch Silver

Also available in nickel finish, suitable for outdoor use.

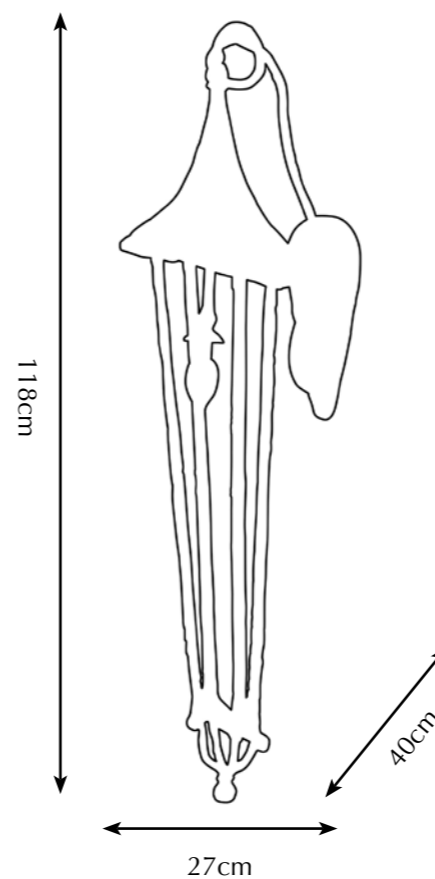

Itemnr: **PA 234 – PA 235**  
Model: Melting Florence wall lantern large  
Material: Casted Brass  
Sockets: G9 max. 25 Watt  
Finishes: Dutch Silver

Also available in nickel finish, suitable for outdoor use.





EVERYTHING YOU CAN IMAGINE IS REAL

PABLO PICASSO

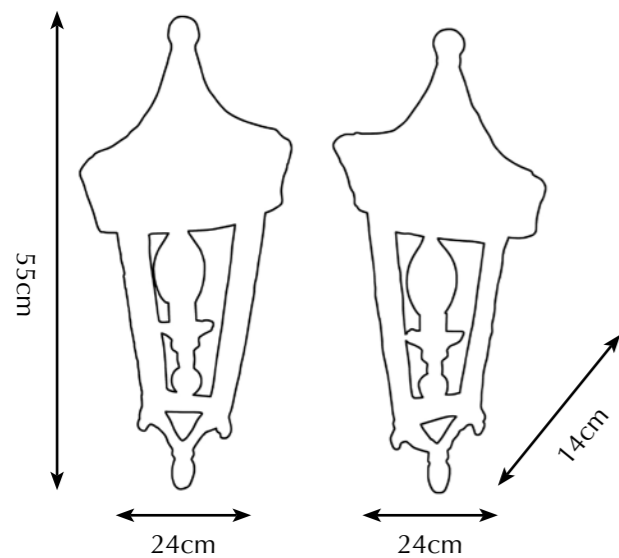
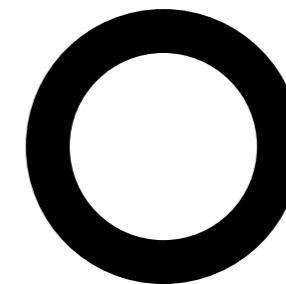

Itemnr: **PA 230 - PA 231**  
Model: Melting Florence wall lantern small  
Material: Casted Brass  
Sockets: G9 max. 25 Watt  
Finishes: Dutch Silver

\* Also available in nickel finish suitable for outdoor use.



## FRIDAY NIGHT AT THE BEACH

In his few spare moments, Pieter Adam finds the opportunity to do what he likes best: create objects fully corresponding with his idea of beautiful design. These dancing figures are remarkably lifelike and vividly shaped showing the designer's positive attitude and passion for the good and beautiful things in life. Casted in brass and finished in silver or gold, this sculpture truly shows Pieter Adam's great attention to detail and dedication to his craft. This is the first design within a series which will soon be expanded to include more sculptures.

Itemnr: **PA 601**  
Material: Casted Brass  
Dimensions: L75xD20xH45cm  
Finishes: -Smoked Brass  
          **-Dutch Silver**  
          -Canadian Gold

\* For images of the other finishes visit our website.



Mariëlle



Carola



Anne



Daniëlle

If you have any questions or requests, please do not hesitate to contact us.  
We are always happy to assist!

For news (e.g. new collections, fairs/exhibitions etc.) visit our website or follow us on Facebook.



Distribution of Pieter Adam™ by:

**Lumière**

Lopikerweg oost 126

NL-3411 LZ LOPIKERKAPEL - The Netherlands

T +31 (0) 348 55 13 40 info@pieter-adam.com

F +31 (0) 348 55 30 04 www.pieter-adam.com

# MADE ON EARTH

Copyright © 2017 Pieter-Adam. All rights reserved.

Unless otherwise indicated, all models, materials, images, on these pages are copyrighted by Pieter-Adam.  
All rights reserved. No part of these pages, models, either text or image may be used.

Graphic Design by A.Graphique - [www.a-graphique.nl](http://www.a-graphique.nl)

