



AIARDINI
MILANO

FABBRICA ITALIANA LAMPADARI

FILOSOFIA

Nella filosofia aziendale di AIARDINI, fabbrica italiana di illuminazione, si pone particolare attenzione non solo a proporre collezioni che risultino di gradimento sul mercato, ma soprattutto al loro livello qualitativo.

Questo è di fondamentale importanza e ragione per la quale vengono utilizzati solo i migliori materiali, come i vetri soffiati veneziani e cristalli Swarovski.

Il processo evolutivo del know-how sviluppatosi in questi anni ha unito la nostra esperienza artigianale con i migliori studi di architettura, per soddisfare le richieste sempre più esigenti di una clientela, sia residenziale che alberghiera, che pone la sua attenzione alla qualità e alla ricercatezza di un design raffinato, che risulta essere apprezzato in ben venti Paesi del mondo.

PHILOSOPHY

Into Aiardini corporate philosophy, an Italian handmade lights manufacturer, attention is paid not only to offer collections being attractive to the market, but also and especially to ensure a very high quality level of its products. This is extremely important and reason why the best materials only are used, such as blown Venetian glass and Swarovski crystals.

The evolutionary process of the know-how developed in recent years has combined our experience crafted with the finest architecture studios in order to meet the increasingly demanding needs of both private and hospitality customers focused on the quality and sophistication of a refined design, which has proved to be appreciated in twenty countries in the world.

AIARDINI

3

философия

В корпоративной философии итальянской фабрики освещения, ручной работы, Aiardini положен принцип приделения внимания не только коллекции более востребованной на рынке, но и индивидуальный подход к каждому клиенту, что обеспечивает очень высокий уровень продукции. Это чрезвычайно важно потому используются самые лучшие материалы, например, венецианское стекло и кристаллы Сваровски.

Эволюционный процес ноу-хау, разработанный в последние годы, в сочетании опыта создания коллекций с лучшими архитектурными студиями дает возможность удовлетворять все более жесткие требования как частных клиентов, так и больших корпоративных заказчиков. Aiardini сосредоточены не только на качестве и изысканности, но и утонченным дизайне, который признан в двадцати странах мира.

AIARDINI® è un marchio registrato e tutti i modelli sono depositati e protetti per il copyright in ambito internazionale.

AIARDINI® is a registered trademark, and every its creation is a lodged model protected by copyright.

AIARDINI® является зарегистрированным товарным знаком и все модели зарегистрированы и защищены авторскими правами на международном уровне.

Milan · New York · Edimburgo · Moscow · Abu Dhabi · Dubai
St. Louis · Amburgo · Amsterdam · Warsaw · London · Paris · Tokyo
St. Petersburg · Nice · Praga · Oslo · Oman · Seoul · Frankfurt

le nostre collezioni
our collections

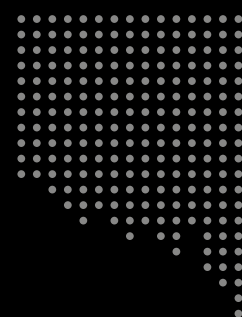

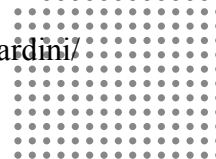

art.		pag.
119	· Soffio	9
135	· Alice	19
129	· Gabriel	27
134	· Nina	37
128	· Dolcevita	47
203	· Giulietta	55
117	· Esmeralda	61
123	· Glamour	69
118	· Elettra	79
126	· Elegance	85
100	· Ottagono	95
101	· Ginevra	101
204	· Flavia	111
120	· Sinfonia	121
136	· Lisa	131
121	· Chanel	141
110	· Tango	145
133	· Melody	153

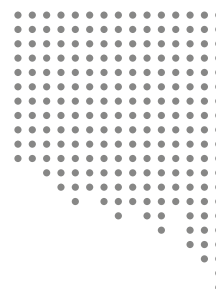



art. 119 - Soffio



art. 135 - Alice



art. 129 - Gabriel



art. 134 - Nina



art. 128 - Dolcevita



art. 203 - Giulietta



art. 117 - Esmeralda



art. 123 - Glamour



art. 117 - Elettra



art. 126 - Elegance



art. 100 - Ottagono



art. 101 - Ginevra



art. 204 - Flavia



art. 120 - Sinfonia



art. 136 - Lisa



art. 121 - Chanel



art. 110 - Tango

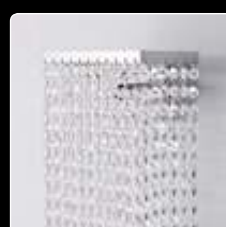

art. 133 - Melody

serie
series

119

Soffio

soffiatori di vetro... la forza di una cultura italiana!
glassblowers, the strength of Italian culture!
воздуходувки, стекло... Сила, культуры, итальянский !

Struttura: metallo e parti in ottone
Diffusori: paralumi cilindrici in tessuto
Fusto e Bobeches: in vetro soffiato trasparente Veneziano
Braccetti: in metallo
Decorazioni pendenti: in cristallo
Finiture: cromo lucido, oro lucido, oro satinato, nichel satinato
Rosoni a soffitto: in metallo

*Structure: metal and brass parts
Diffusers: white cylindrical fabric lampshades
Stem and Bobeches: transparent blown glass, Venetian
Arms: Metal
Pendants decorations: in crystal
Finishing: polished chrome, polished gold, satin gold, satin nickel
Ceiling roses: Metal*

Структура: латунь и металлические части
Диффузоры: цилиндрические абажуры из ткани
Стволовые и Bobeches, прозрачный выдувное стекло, венецианское
Оружие: Металл
Подвески украшения: в кристалле
Отделка: полированный хром, полированный золото, сатин золото, матовый никель
Потолочные розы: Металлические

Disegni, dimensioni e varianti a pagina 17



AIARDINI

9

AIARDINI

10



Soffio





AIARDINI

12



LUSTRO GRAD
ОПТОВЫЕ ПРОДАЖИ СВЕТИЛЬНИКОВ



AIARDINI

14

serie
series

119

Soffio



AIARDINI

15



AIARDINI

16

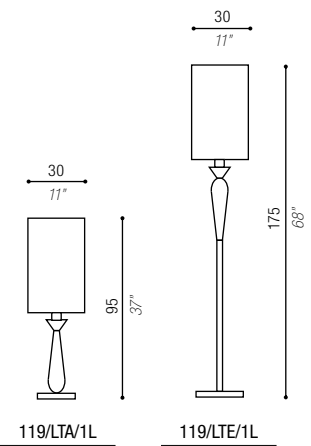
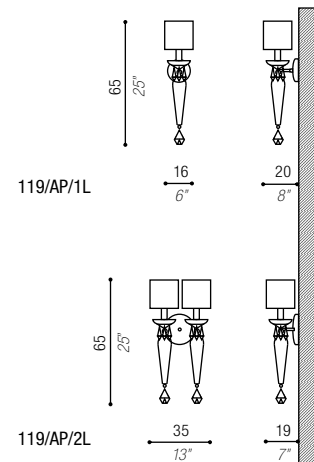
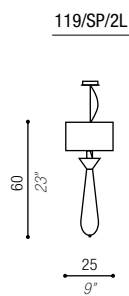
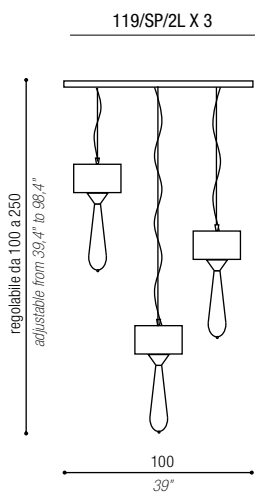
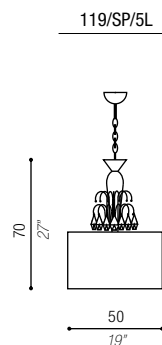
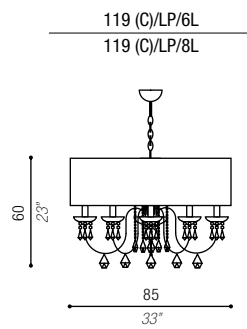
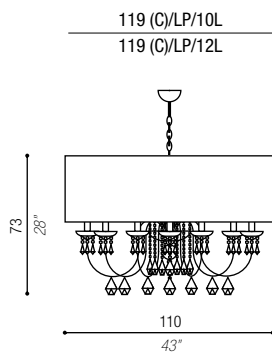
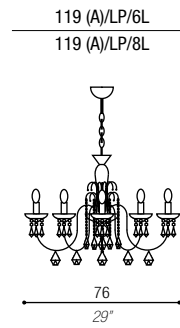
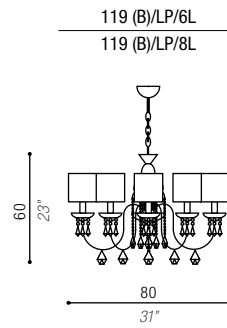
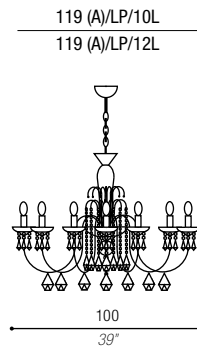
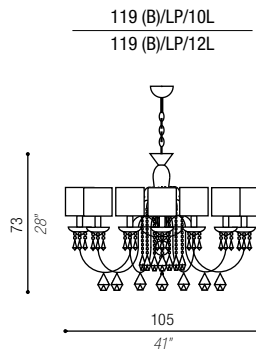

versioni disponibili



legenda a pag. 159

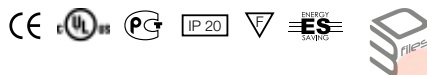
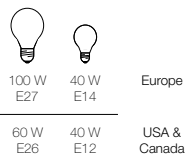

serie
series

135

Alice

il silenzio della luce, pura seduzione!
the silent of light, pure seduction!
Молчание света, чистого соблазнения!

Struttura: metallo e parti in ottone
Finitura: laccato bianco
Diffusori: paralumi troncoconici in tessuto rigido
Decorazioni pendenti: sfere di vetro con gocce di cristallo sfaccettate
Rosoni a soffitto: in metallo

*Structure: metal and brass parts
Finishing: lacquered white
Diffusers : conical lampshades in stiff fabric
Pendants decorations: glass beads, with crystal drops faceted
Finishing: polished chrome, polished gold, satin gold, satin nickel
Ceiling roses: Metal*

Структура: латунь и металлические части
Отделка: лакированный белый
Абажур: конической жесткой ткани
украшения Подвески: стеклянные бусины, с кристалльно капли граненый
Отделка: полированный хром, полированный золото, сатин золото, матовый никель
Потолочные розы: Металлические

Disegni, dimensioni e varianti a pagina **25**



AIARDINI

19



LUSTRO GRAD
ОПТОВЫЕ ПРОДАЖИ СВЕТИЛЬНИКОВ



LUSTRO GRAD
ОПТОВЫЕ ПРОДАЖИ СВЕТИЛЬНИКОВ



LUSTRO GRAD
ОПТОВЫЕ ПРОДАЖИ СВЕТИЛЬНИКОВ





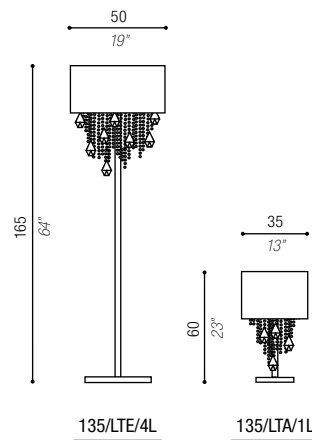
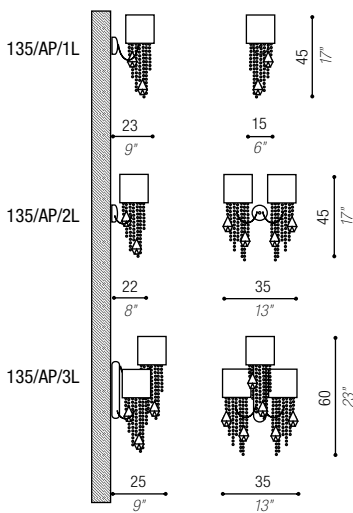
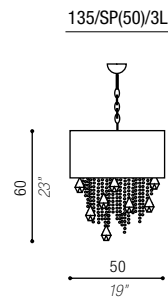
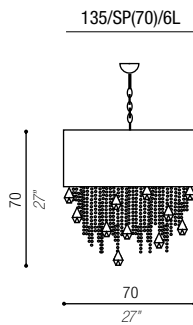
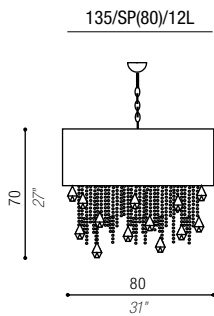
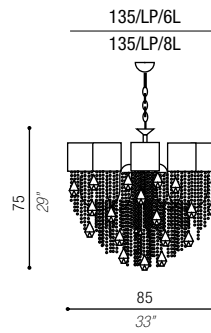
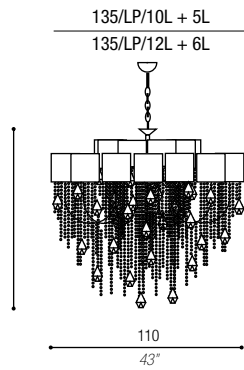
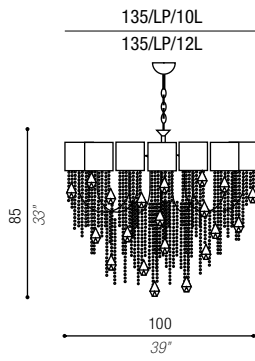

versioni disponibili



legenda a pag. 159

		Europe
100 W E27	40 W E14	
60 W E26	40 W E12	USA & Canada



serie
series

129

Gabriel

vivere brillantemente, un sogno possibile!

live brilliantly, a possible dream!

жить ярко, возможные мечты!

Struttura: metallo e parti in ottone
Diffusori: paralumi cilindrici in tessuto bianco
Bobeches: cristallo trasparente
Decorazioni pendenti: sfere sfaccettate in cristallo Swarovski
Finiture: cromo lucido, oro lucido, oro satinato, nichel satinato
Rosoni a soffitto: in metallo

*Structure: metal and brass parts
Diffusers: white cylindrical fabric lampshades
Bobeches: transparent crystal
Pendants decorations: faceted crystal balls Swarovski
Finishing: polished chrome, polished gold, satin gold, satin nickel
Ceiling roses: Metal*

Структура: латунь и металлические части
Диффузоры: белый цилиндрические из ткани абажуры
Bobeches: прозрачный кристалл
Подвески украшения: граненый хрустальные шары Swarovski
Отделка: полированный хром, полированный золото, сатин золото, матовый никель
Потолочные розы: Металлические

Disegni, dimensioni e varianti a pagina 35



AIARDINI

27











AIARDINI

32





AIARDINI

34

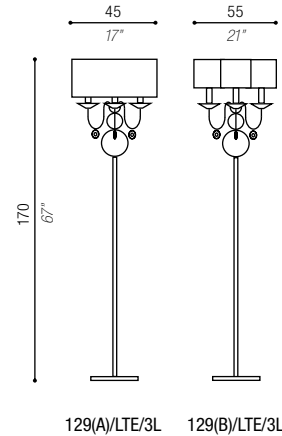
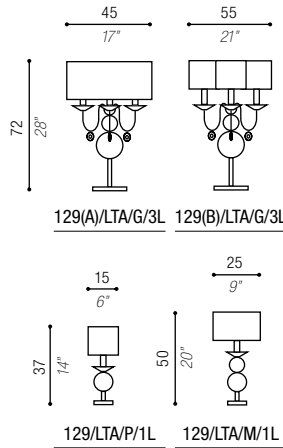
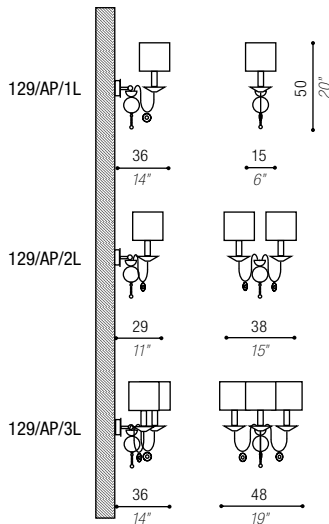
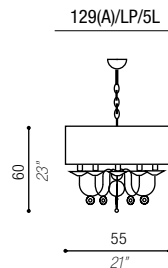
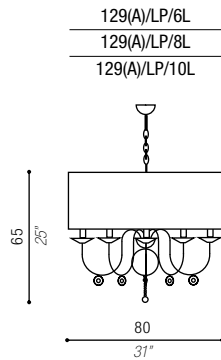
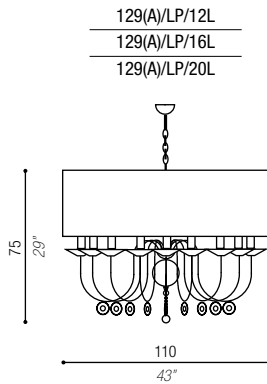
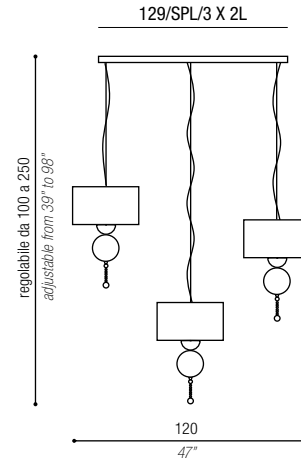
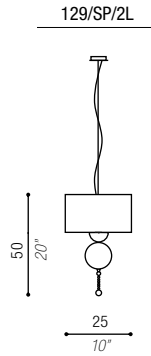
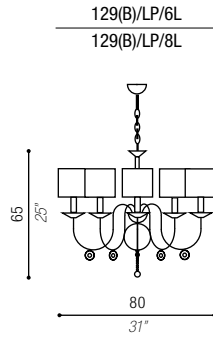
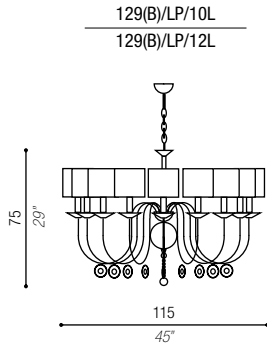

versioni disponibili



legenda a pag. 159

40 W E14 Europe
40 W E12 USA & Canada



serie
series

134

Nina

il linguaggio emozionale della luce!
the emotional language of light!
ЭМОЦИОНАЛЬНЫМ ЯЗЫКОМ СВЕТА!

Struttura: metallo e parti in ottone
Diffusori: paralumi cilindrici in tessuto rigido
Decorazioni pendenti: catene di cristalli, con anelli in ottone
Finiture : cromo lucido, oro lucido, oro satinato, nichel satinato
Rosoni a soffitto: in metallo

*Structure: metal and brass parts
Diffusers: cylindrical fabric lampshades drive
Decorations hanging: chains of crystals, with brass rings
Finishing: polished chrome, polished gold, satin gold, satin nickel
Ceiling roses: Metal*

Структура: латунь и металлические части
Диффузоры: цилиндрические абажуры из ткани езды
Декорации висит цепи кристаллов, с медными кольцами
Отделка: полированный хром, полированный золото, сатин золото, матовый никель
Потолочные розы: Металлические

Disegni, dimensioni e varianti a pagina 45



AIARDINI

37







AIARDINI

40





LUSTRO GRAD
ОПТОВЫЕ ПРОДАЖИ СВЕТИЛЬНИКОВ





AIARDINI

44

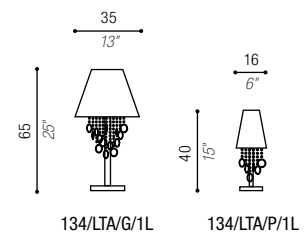
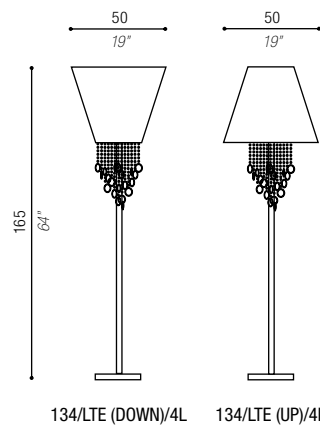
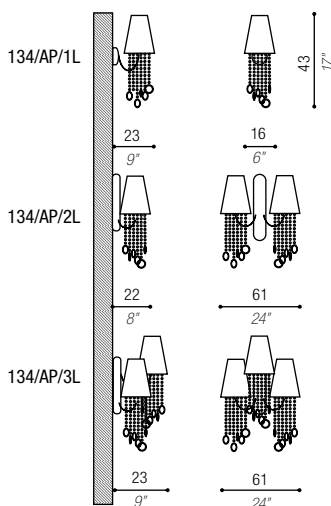
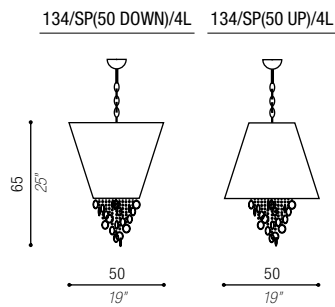
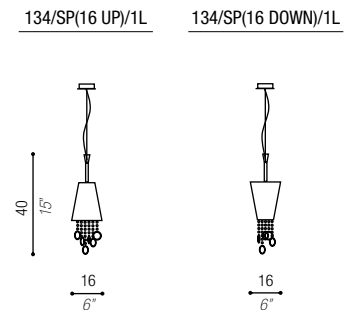
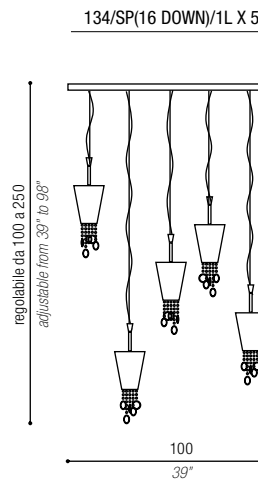
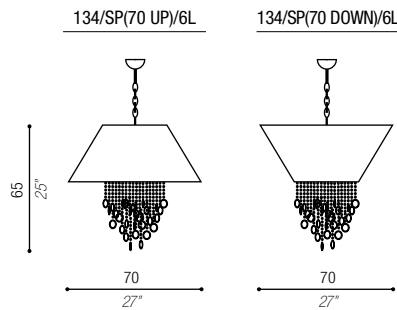
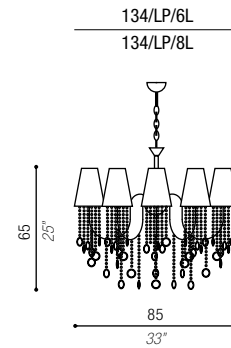
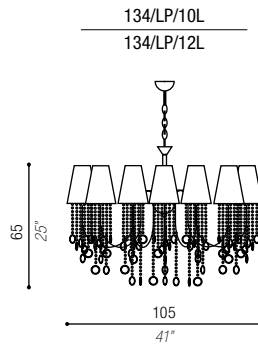
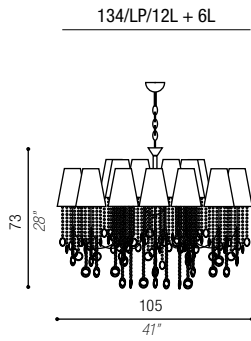

versioni disponibili



legenda a pag. 159

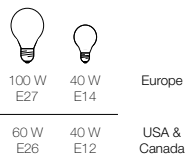

serie
series

128

Dolcevita

bianco puro e stile contemporaneo!
pure white and contemporary style!
Чистый белый и современный стиль!

Struttura: legno tornito, braccetti in metallo
Finitura: laccato bianco

Diffusori: paralumi modello pagoda americano bianco

Decorazioni pendenti: perline sfaccettate in cristallo Swarovski, gocce sfaccettate e perline lisce in vetro Bianco

Rosoni a soffitto: in metallo

Structure: Turned wood with metal arms

Finishing: lacquered white

Ceiling roses: metal finishing in polished chrome

Diffusers: white fabric American pagoda lampshade

Pendant decorations: faceted beads crystal Swarovski, faceted drops and polished pearls in white glass.

Ceiling roses: Metal

Структура: точеной древесины с металлическими оружия

Отделка: лакированный белый

Потолочные розы: металл отделка из полированного хрома

Диффузоры: белая ткань Американский пагода абажур

Подвесные украшения: граненые бусины кристалл Swarovski, граненый капли и полированные жемчуг в белого стекла.

Потолочные розы: Металлические

Disegni, dimensioni e varianti a pagina 53



AIARDINI

47







AIARDINI

50





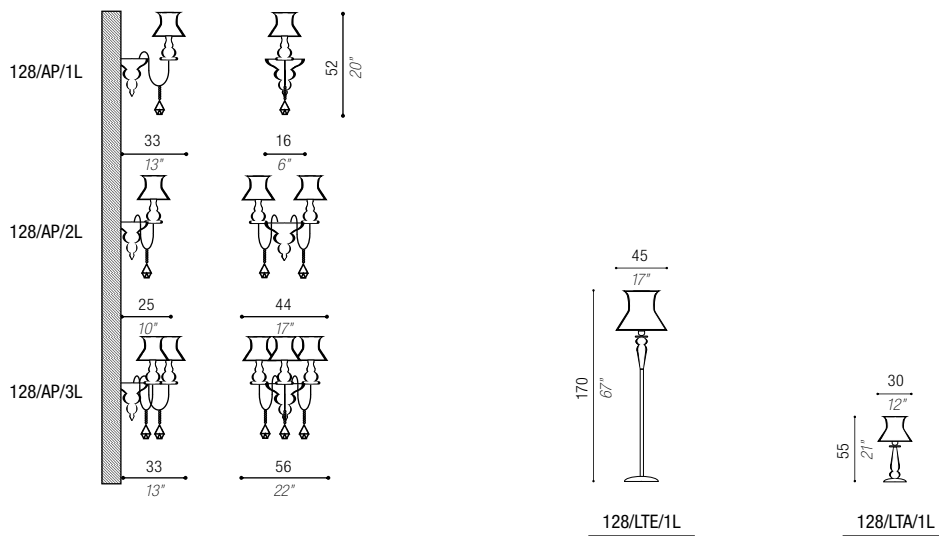
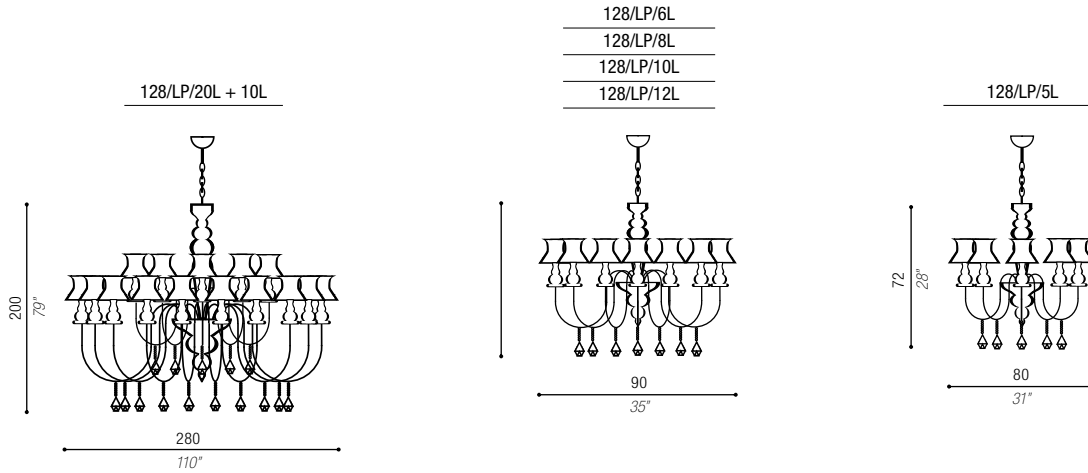

versioni disponibili



legenda a pag. 159

		Europe
100 W E27	40 W E14	
60 W E26	40 W E12	USA & Canada



serie
series

203

Giulietta

Idee italiane, uno stile di vita!

Italian ideas, a lifestyle!

Итальянские идеи, стиль жизни!

Struttura: metallo e parti in ottone
Diffusori: paralumi cilindrici in tessuto rigido
Decorazioni pendenti: catene di cristallo
Finiture : cromo lucido, oro lucido, oro satinato, nichel satinato
Rosoni a soffitto: in metallo

*Structure: metal and brass parts
Diffusers: cylindrical fabric lampshades drive
Decorations pendants: crystal chains
Finishing: polished chrome, polished gold, satin gold, satin nickel
Ceiling roses: Metal*

Структура: латунь и металлические части
Диффузоры: цилиндрические абажуры из ткани езды
Украшения подвески: хрустальные цепи
Отделка: полированный хром, полированный золото, сатин золото, матовый никель
Потолочные розы: Металлические

Disegni, dimensioni e varianti a pagina 59





LUSTROGRAD
ОПТОВЫЕ ПРОДАЖИ СВЕТИЛЬНИКОВ



serie
series

203

Giulietta

AIARDINI

57



LUSTRO GRAD
ОПТОВЫЕ ПРОДАЖИ СВЕТИЛЬНИКОВ



AIARDINI

58

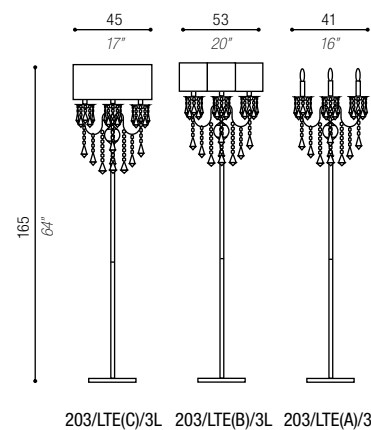
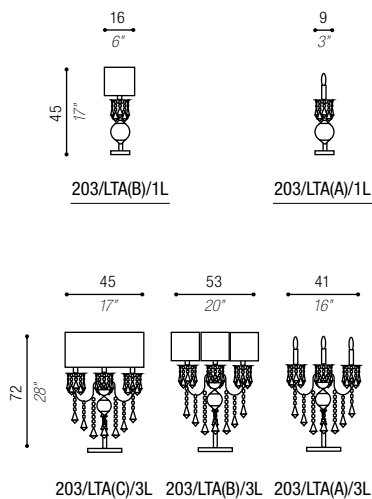
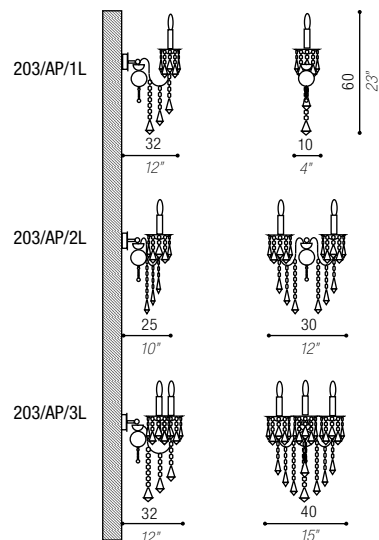
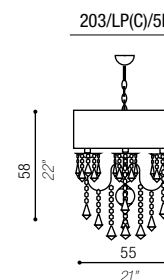
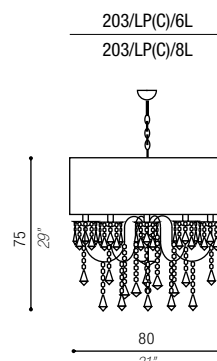
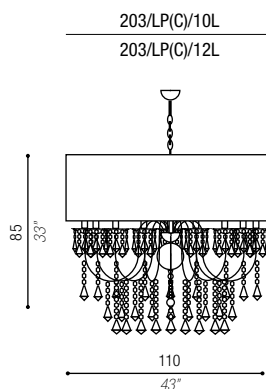
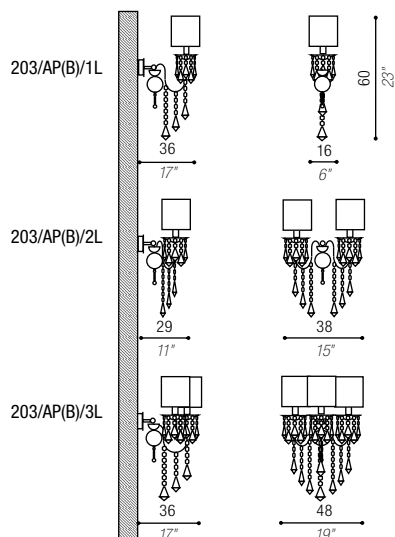
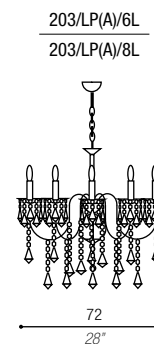
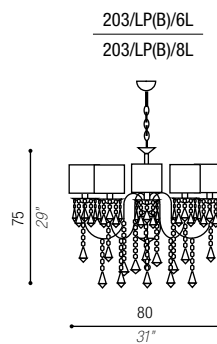
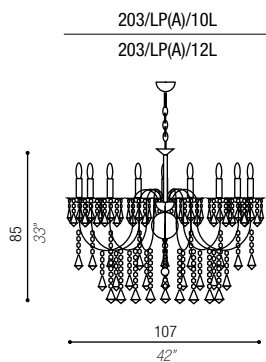
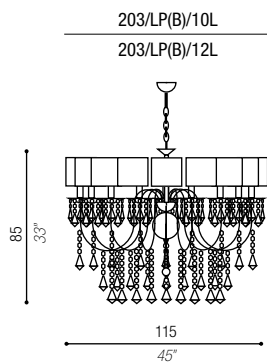

versioni disponibili



legenda a pag. 159

40 W
E14 Europe

40 W
E12 USA &
Canada



serie
series

117

Esmeralda

la Vanità, debolezza irresistibile!
vanity, irresistible weakness!
Тщеславие, слабость неотразимы!

Struttura: ottone e parti in metallo
Diffusori: paralumi cilindrici in tessuto rigido
Decorazioni pendenti: catene di cristalli, con anelli in ottone
Finiture : cromo lucido, oro lucido, oro satinato, nichel satinato
Rosoni a soffitto: in metallo

*Structure: brass and metal parts
Diffusers: cylindrical fabric lampshades drive
Decorations hanging chains of crystals, with brass rings
Finishing: polished chrome, polished gold, satin gold, satin nickel
Ceiling roses: Metal*

Структура: латунь и металлические части
Диффузоры: цилиндрические абажуры из ткани езды
Украшения висит: цепи кристаллов, с медными кольцами
Отделка: полированный хром, полированный золото, сатин золото, матовый никель
Потолочные розы: Металлические

Disegni, dimensioni e varianti a pagina 67



AIARDINI

61







Esmeralda



AIARDINI

66



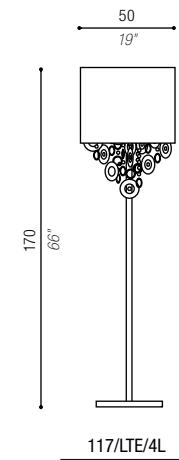
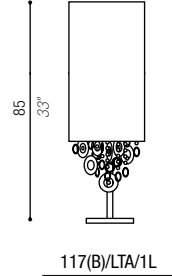
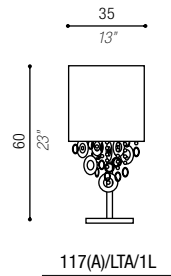
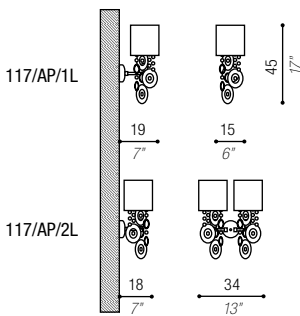
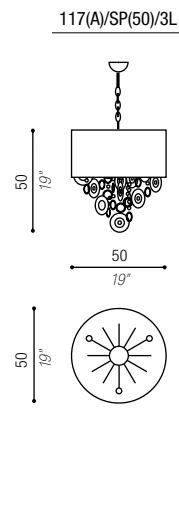
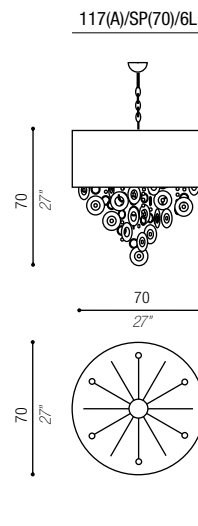
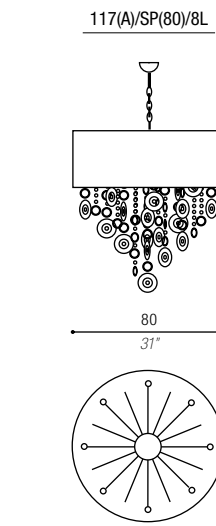
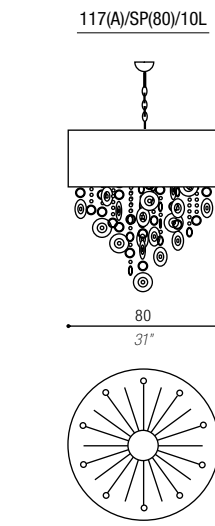
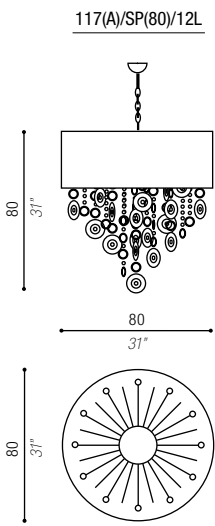
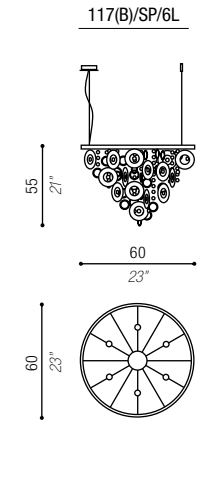
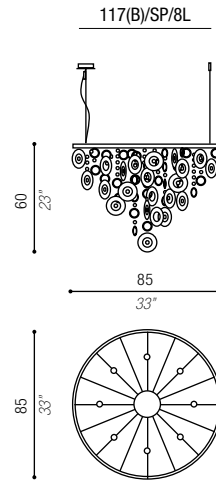
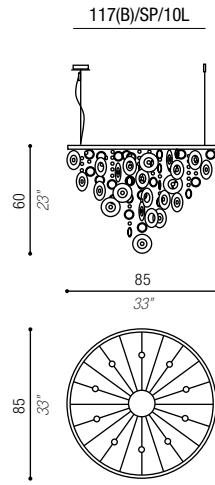
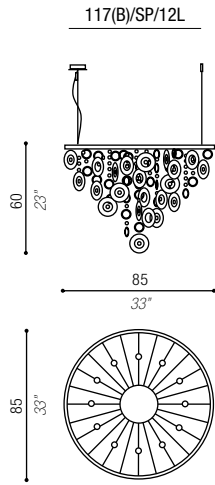

versioni disponibili



legenda a pag. 159

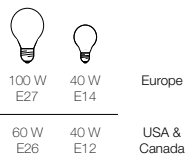

serie
series

123

Glamour

il fascino e l'eleganza del cristallo, con i pendagli veneziani
the charm and elegance of crystal, with the pendants Venziani
шарм и элегантность кристалла, с подвесками Venziani

Struttura: metallo e parti in ottone
Diffusori: paralumi cilindrici in tessuto rigido
Decorazioni pendenti: tondo realizzato con catene pendenti in cristallo e gocce di vetro veneziano.
Finiture: cromo lucido, oro lucido, oro satinato, nichel satinato
Rosoni a soffitto: in metallo

*Structure: metal and brass parts
Diffusers: cylindrical fabric lampshades
Decorations pendants: round made by crystal pendants hains and venetian glass drops
Finishing: polished chrome, polished gold, satin gold, satin nickel
Ceiling roses: metal*

Структура: латунь и металлические части
Диффузоры: цилиндрические абажуры из ткани
Украшения подвески: круглые, сделанные хрустальными подвесками Hains и венецианское стекло капли
Отделка: полированный хром, полированный золото, сатин золото, матовый никель
Потолочные розы: металл

Disegni, dimensioni e varianti a pagina 77



AIARDINI

69

AIARDINI

70











AIARDINI

74





AIARDINI

76

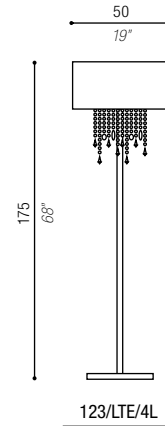
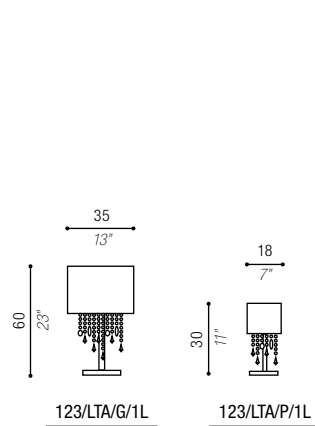
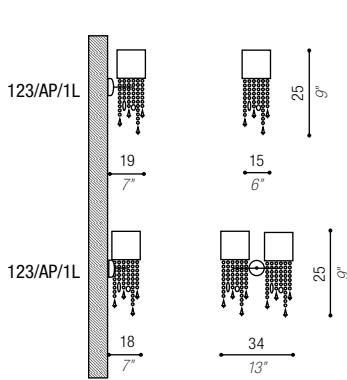
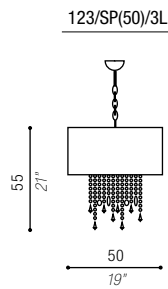
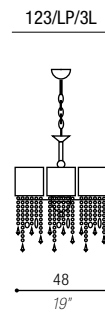
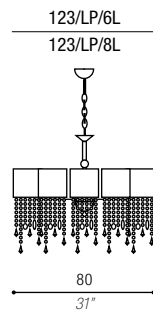
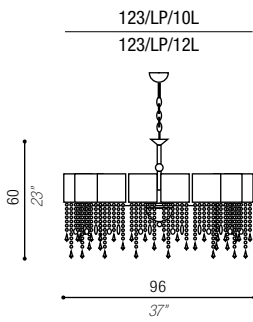
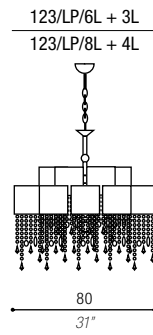
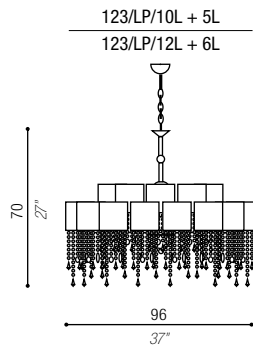

versioni disponibili



legenda a pag. 159

100 W E27
40 W E14
Europe

60 W E26
40 W E12
USA & Canada



serie
series

118

Elettra

nuovi concetti espressivi per l'illuminazione
new expressive concepts for lighting
новые выразительные концепции для освещения

Struttura: metallo e parti in ottone
Diffusori: paralumi cilindrici in tessuto rigido
Bobeches: cristallo trasparente
Finiture: cromo lucido, oro lucido, oro satinato, nichel satinato
Rosoni a soffitto: in metallo

*Structure: metal and brass parts
Diffusers: cylindrical fabric lampshades
Bobeches: cristal transparent
Finishing: polished chrome, polished gold, satin gold, satin nickel
Ceiling roses: metal*

Структура: латунь и металлические части
Диффузоры: цилиндрические абажуры из ткани
Bobeches: Cristal прозрачный
Отделка: полированный хром, полированный золото, сатин золото, матовый никель
Потолочные розы: металл

Disegni, dimensioni e varianti a pagina 83



AIARDINI

79





AIARDINI

82



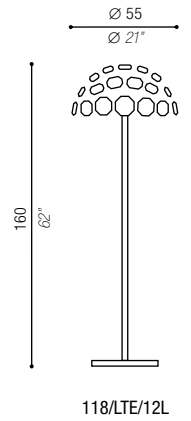
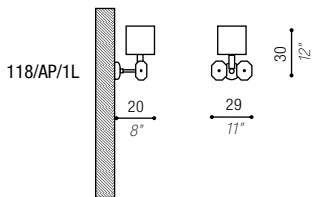
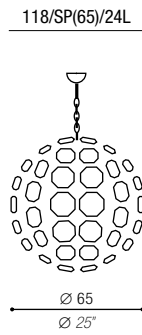
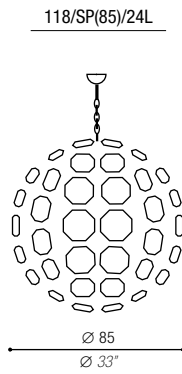
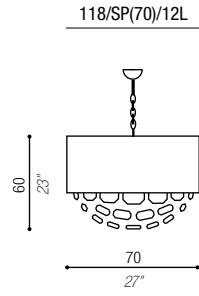
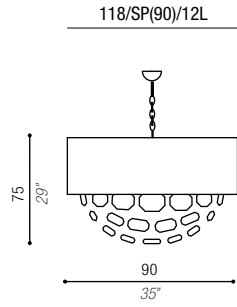

versioni disponibili



legenda a pag. 159



40 W
E14

Europe
USA &
Canada



serie
series

126

Elegance

luci e ombre, sensazioni magiche!
lights and shadows, magic sensations!
света и тени, волшебные ощущений!

Struttura: ottone e parti in metallo
Diffusori: paralumi troncoconici in tessuto rigido
Decorazioni pendenti: perle sfaccettate in cristallo chiaro e gocce sfaccettate in cristallo ambra Swarovski
Finiture: cromo lucido, oro lucido, oro satinato, nichel satinato

*Structure: brass and metal parts
Diffusers: truncated conical fabric lampshades
Pendants decorations: clear faceted crystal beads and amber crystal drops Swarovski
Finishing: polished chrome, polished gold, satin gold, satin nickel*

Структура: латунь и металлические части
Диффузоры: усеченного конуса ткани абажуры
Подвески украшения: прозрачный граненого хрусталя бусы и янтарь кристалл падает Swarovski
Отделка: полированный хром, полированный золото, сатин золото, матовый никель

Disegni, dimensioni e varianti a pagina 93



AIARDINI

85













serie
series

126

Elegance

AIARDINI

91



AIARDINI

92

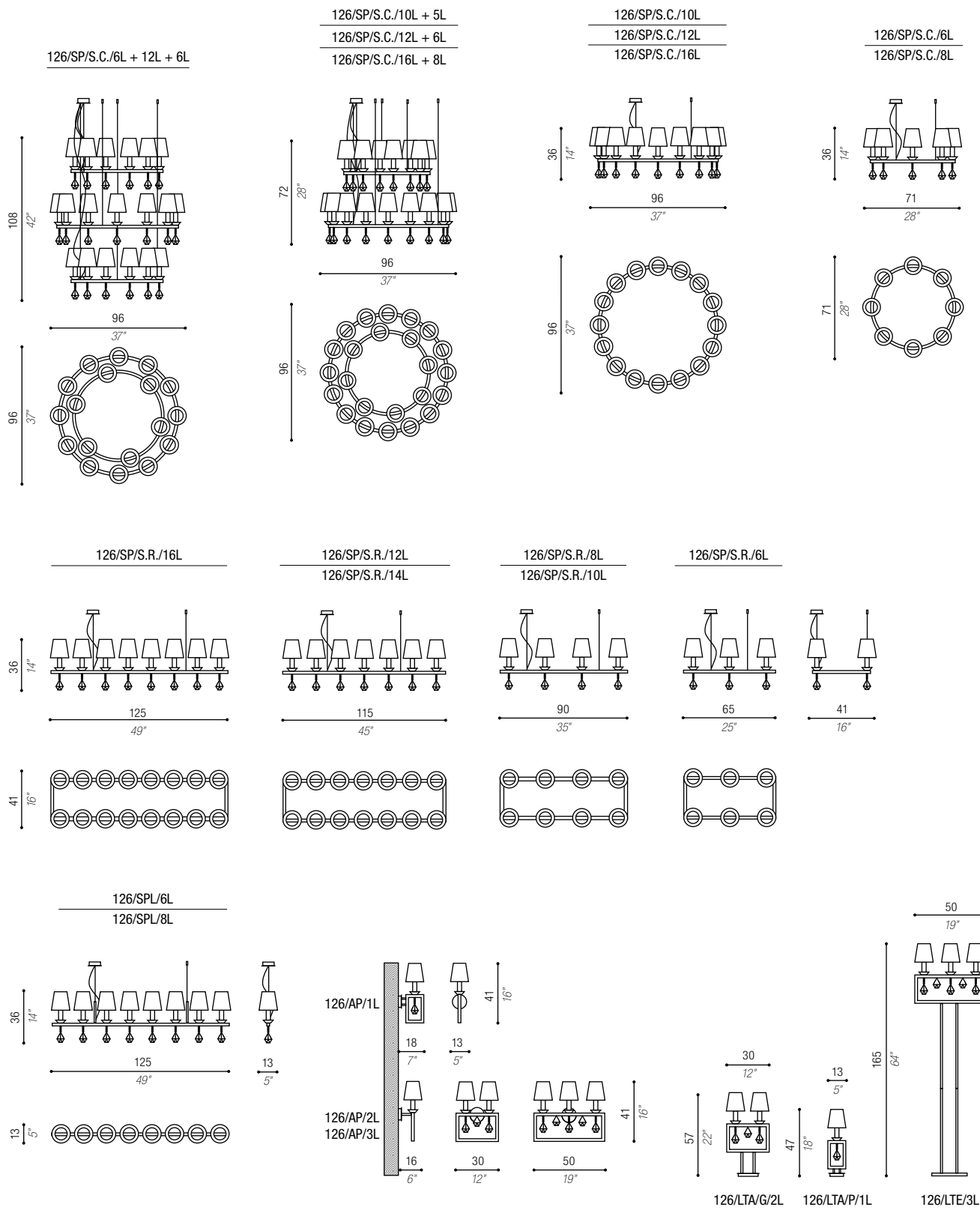

versioni disponibili



legenda a pag. 159

40 W
E14 Europe

40 W
E12 USA &
Canada



LUSTROGRAD
ОПТОВЫЕ ПРОДАЖИ СВЕТИЛЬНИКОВ

serie
series

100

Ottagono

illuminazione versatile, unità modulari per speciali esigenze
versatile lighting, modular units for special needs
разносторонний освещение, модульные блоки для специальных потребности

Struttura: ottone e parti in metallo
Diffusori: paralumi troncoconici in tessuto rigido
Bobeches in vetro smerigliato: disponibili in trasparente
Decorazioni pendenti: gocce di cristallo sfaccettate
Finiture: cromo lucido, oro lucido, oro satinato, nichel satinato

*Structure: brass and metal parts
Diffusers: truncated conical fabric lampshades
Bobeches in ground glass: available either in transparent
Pendants decorations: faceted crystal drops
Finishing: polished chrome, polished gold, satin gold, satin nickel*

Структура: латунь и металлические части
Диффузоры: усеченного конуса ткани абажуры
Bobeches в матовом стекле: в наличии либо в прозрачном
Подвески украшения: граненые хрустальные капли
Отделка: полированный хром, полированный золото, сатин золото, матовый никель

Disegni, dimensioni e varianti a pagina 99



AIARDINI

95



AIARDINI

96



AIARDINI

98



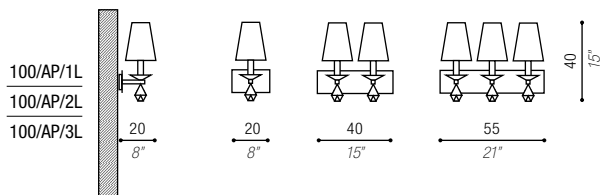
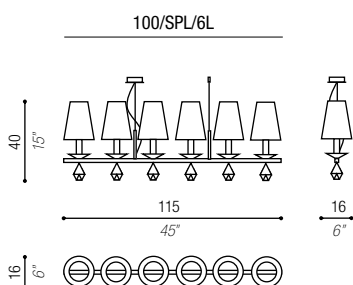
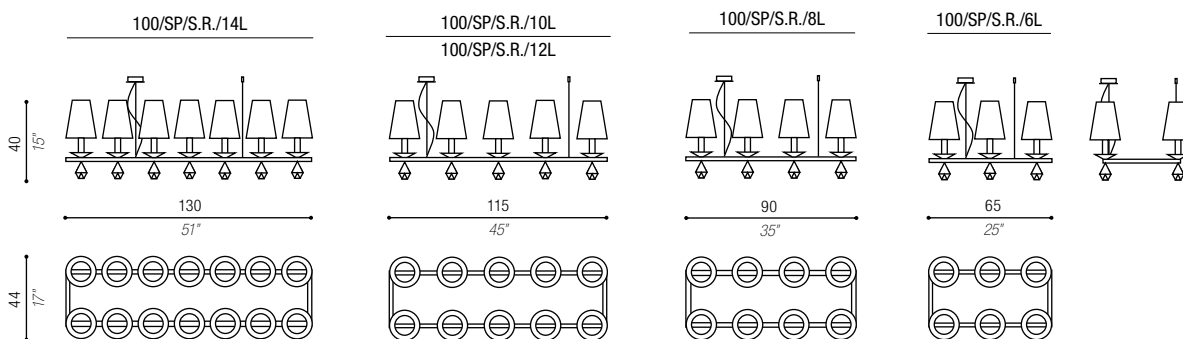
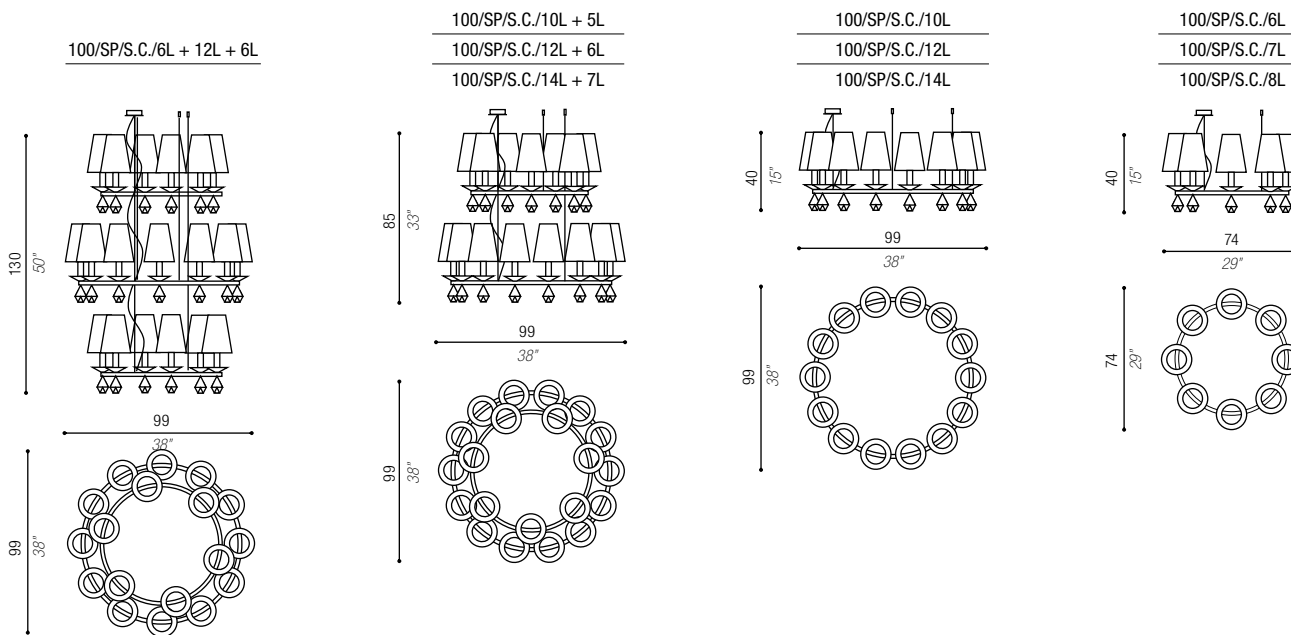

versioni disponibili



legenda a pag. 159

40 W
E14 Europe

40 W
E12 USA &
Canada



LUSTROGRAD
ОПТОВЫЕ ПРОДАЖИ СВЕТИЛЬНИКОВ

serie
series

101

Ginevra

l'incontro tra luce e design!
light and design meeting!
Встреча между светом и дизайном!

Struttura: ottone e parti in metallo
Diffusori: paralumi cilindrici in tessuto
Decorazioni pendenti: gocce di cristallo sfaccettate
Finiture : cromo lucido, oro satinato, nichel satinato

Structure: brass and metal parts
Diffusers: cylindrical fabric lampshades
Pendants decorations: faceted crystal drops Finishing: polished chrome, polished gold, satin gold, satin nickel

Структура: латунь и металлические части
Диффузоры: усеченного конуса ткани абажуры
Вобешес в матовом стекле: в наличии либо в прозрачном
Подвески украшения: граненые хрустальные капли
Отделка: полированный хром, полированный золото, сатин золото, матовый никель

Disegni, dimensioni e varianti a pagina 109



AIARDINI

101





LUSTROGRAD
ОПТОВЫЕ ПРОДАЖИ СВЕТИЛЬНИКОВ





LUSTRO GRAD
ОПТОВЫЕ ПРОДАЖИ СВЕТИЛЬНИКОВ



AIARDINI

106

serie
series

101

Ginevra



AIARDINI

107



LUSTROGRAD
ОПТОВЫЕ ПРОДАЖИ СВЕТИЛЬНИКОВ



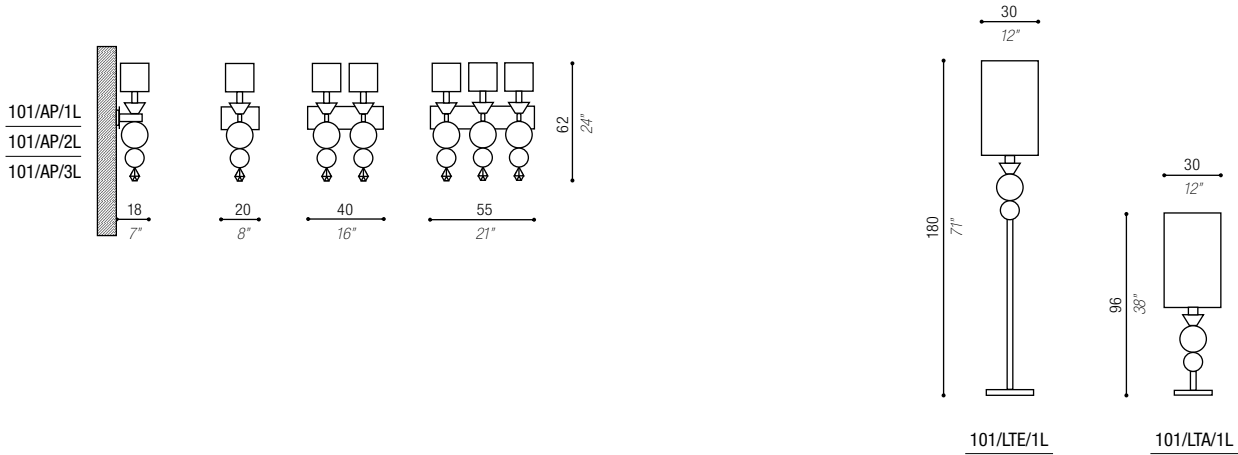
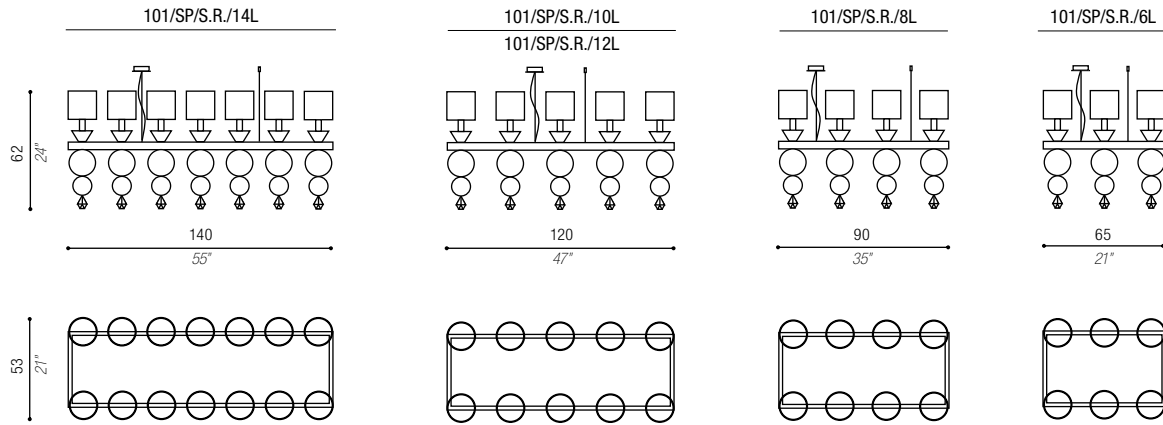
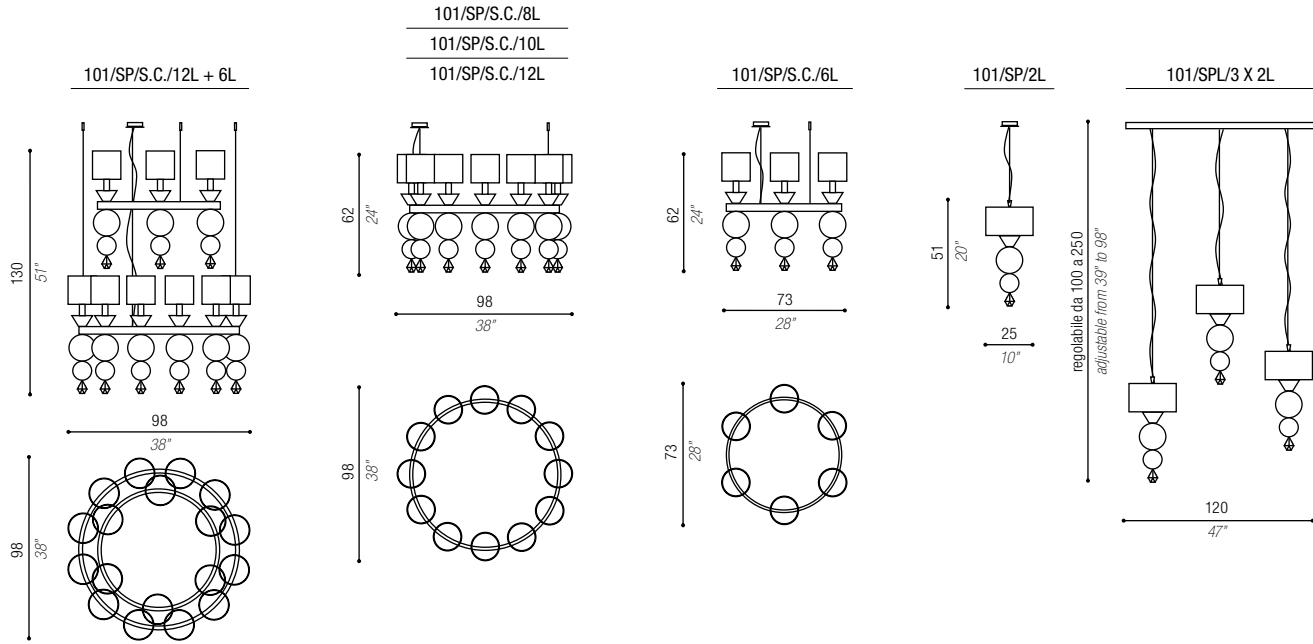

versioni disponibili



legenda a pag. 159

100 W E27
40 W E14
Europe

60 W E26
40 W E12
USA & Canada

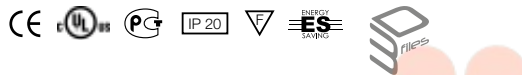

serie
series

204

Flavia

l'incontro tra luce e design!
light and design meeting!
Встреча между светом и дизайном!

Struttura: ottone e parti in metallo
Diffusori: paralumi cilindrici in tessuto rigido
Decorazioni pendenti: con catene e gocce in cristallo
Finiture: cromo lucido, oro lucido, oro satinato, nichel satinato
Rosoni a soffitto: in metallo

*Structure: brass and metal parts
Diffusers: cylindrical fabric lampshades
Pendants decorations: with chains and drops, crystal
Ceiling roses: metal*

Структура: латунь и металлические части
Диффузоры: цилиндрические абажуры из ткани
Подвески украшения: граненые хрустальные капли
Отделка: полированный хром, полированный золото, сатин золото, матовый никель

Disegni, dimensioni e varianti a pagina 119



AIARDINI

111

AIARDINI

112











LUSTRO GRAD
ОПТОВЫЕ ПРОДАЖИ СВЕТИЛЬНИКОВ





AIARDINI

118

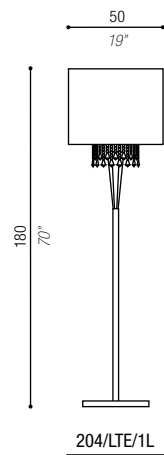
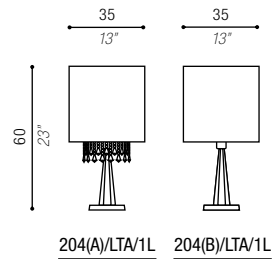
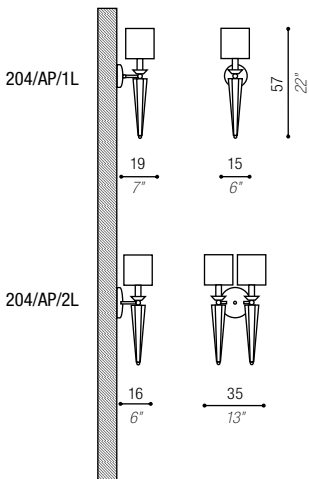
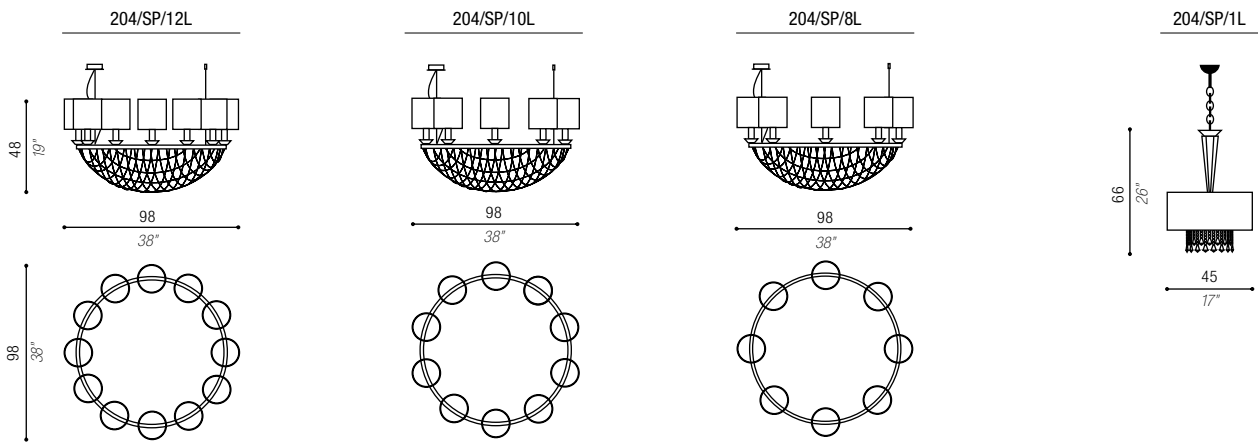
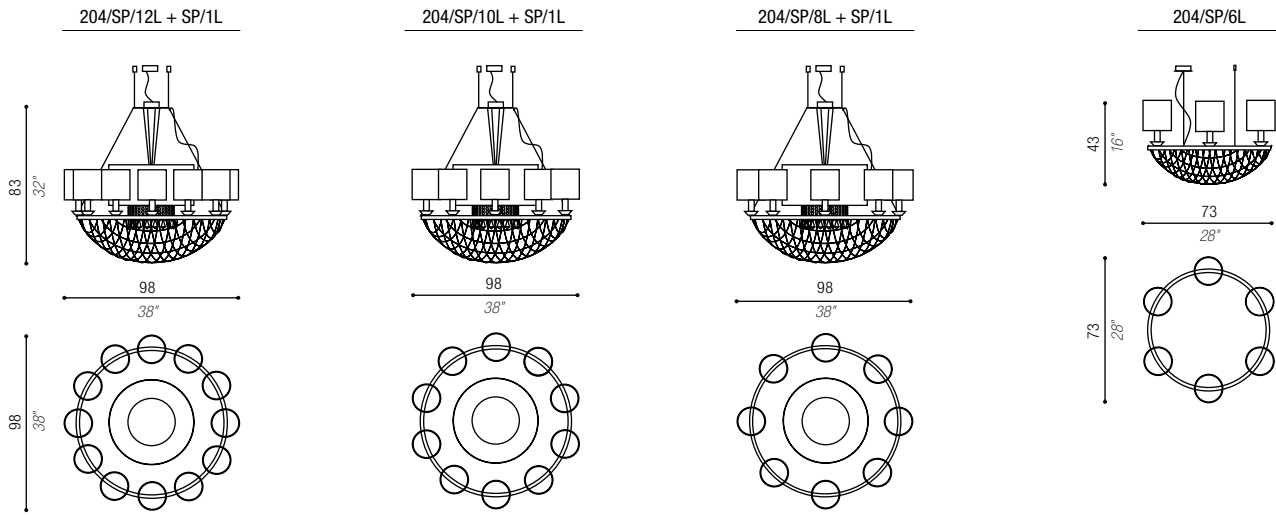

versioni disponibili



legenda a pag. 159

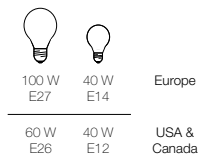

serie
series

120

Sinfonia

antica arte del vetro soffiato, un segreto veneziano!
ancient art of blown glass, a Venetian secret!
Древнее искусство стекла дует, в Венецианский секрет!

Struttura: ottone e parti in metallo
Diffusori: paralumi troncoconici in tessuto rigido
vetri soffiati veneziani in bianco lucido
Decorazioni pendenti: gocce di vetro veneziano
disponibili in bianco, nero oppure ambra
Finiture : cromo lucido, oro lucido, oro satinato, nichel satinato

Structure: brass and metal parts
Speakers: conical lampshades in stiff fabric
Venetian blown glass in gloss white
Decorations pendants: drops of Venetian glass
Available in white, black or amber
Finishes: polished chrome, polished gold, satin gold, satin nickel

Структура: латунь и металлические части
Докладчики: конические абажуры в жесткой ткани
Венецианский выдувное стекло в глянецвый белый
Украшения подвески: капли венецианского стекла
Доступные цвета: белый, черный или янтаря
Отделка: полированный хром, полированный золото, сатин золото, матовый никель

Disegni, dimensioni e varianti a pagina 129



AIARDINI

121



AIARDINI

122







AIARDINI

126





serie
series

120

Sinfonia

AIARDINI

127



AIARDINI

128

120/SP/S.C./6L + 12L + 6L

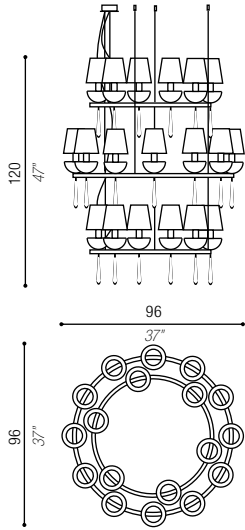

120/SP/S.C./10L + 5L
120/SP/S.C./12L + 6L
120/SP/S.C./16L + 8L

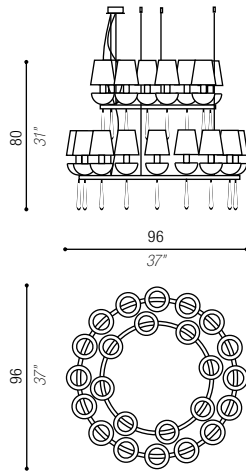

120/SP/S.C./10L
120/SP/S.C./12L
120/SP/S.C./16L

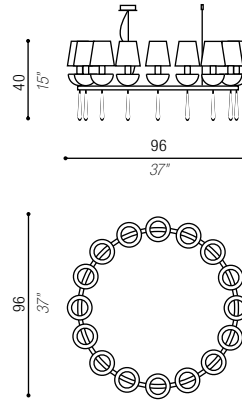

120/SP/S.C./6L
120/SP/S.C./8L

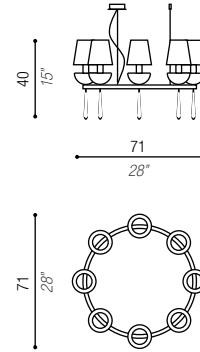

120/SP/S.R./16L

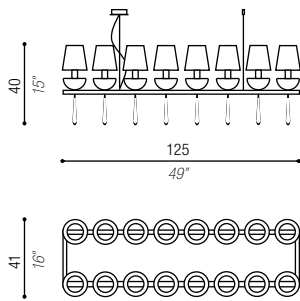

120/SP/S.R./12L
120/SP/S.R./14L

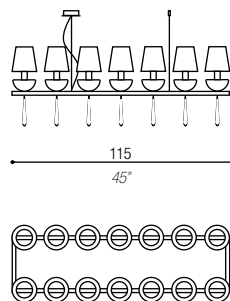

120/SP/S.R./8L
120/SP/S.R./10L

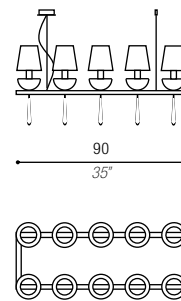

120/SP/S.R./6L

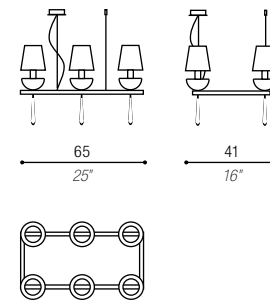

120/SPL/6L
120/SPL/8L

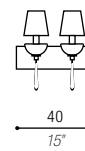
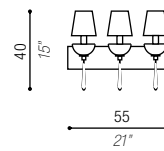
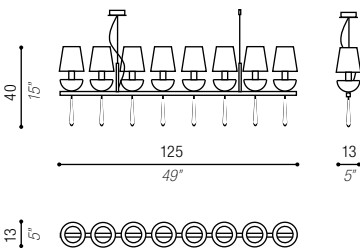

120/AP/1L
120/AP/2L
120/AP/3L

versioni disponibili



legenda a pag. 159

40 W E14 Europe
40 W E12 USA & Canada



serie
series

136

Lisa

una pioggia di cristallo, grandi emozioni!
a shower of crystal, great emotions!
душ из ,кристалл большие эмоции!

Struttura: ottone e parti in metallo
Diffusori: paralumi cilindrici in tessuto rigido
Decorazioni pendenti: catene di cristalli, con anelli in ottone
Finiture: cromo lucido, oro lucido, oro satinato, nichel satinato
Rosoni a soffitto: in metallo

*Structure: brass and metal parts
Diffusers: cylindrical fabric lampshades drive
Decorations hanging chains of crystals, with brass rings
Finishes: polished chrome, polished gold, satin gold, satin nickel
Ceiling roses: Metal*

Структура: латунь и металлические части
Диффузоры: цилиндрические абажуры из ткани езды
Декорации висит цепи кристаллов, с медными кольцами
Отделка: полированный хром, полированный золото, сатин золото, матовый никель
Потолочные розы: Металлические

Disegni, dimensioni e varianti a pagina 139



AIARDINI

131



LUSTRO GRAD
ОПТОВЫЕ ПРОДАЖИ СВЕТИЛЬНИКОВ



serie
series

136

Lisa

AIARDINI

133



LUSTRO GRAD
ОПТОВЫЕ ПРОДАЖИ СВЕТИЛЬНИКОВ



LUSTRO GRAD
ОПТОВЫЕ ПРОДАЖИ СВЕТИЛЬНИКОВ



LUSTRO GRAD
ОПТОВЫЕ ПРОДАЖИ СВЕТИЛЬНИКОВ



LUSTRO GRAD
ОПТОВЫЕ ПРОДАЖИ СВЕТИЛЬНИКОВ



AIARDINI

138



136(B)/SP(80)/12L
136(B)/SP(80)/10L
136(B)/SP(80)/8L

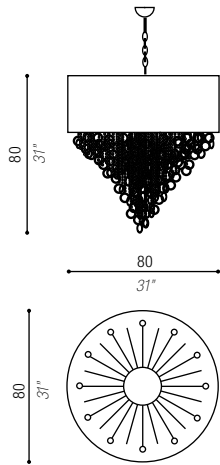

136(B)/SP(70)/6L

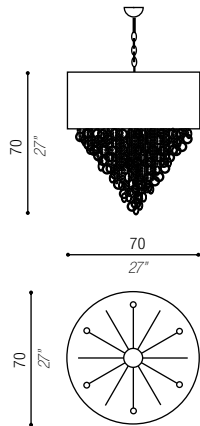

136(B)/SP(50)/3L

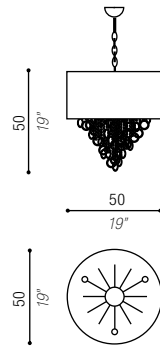

136(C)/SP(85)/12L
136(C)/SP(85)/10L
136(C)/SP(85)/8L

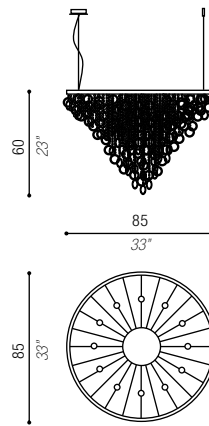

136(C)/SP(60)/6L

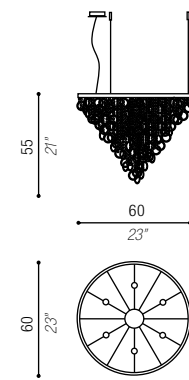

136(A)/SP/12L + 4L
136(A)/SP/10L + 4L
136(A)/SP/8L + 4L

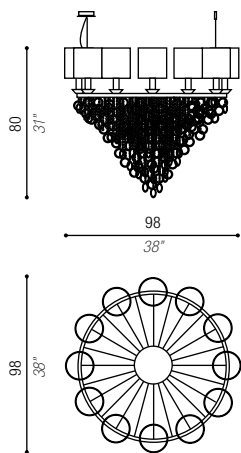

136(A)/SP/6L + 3L

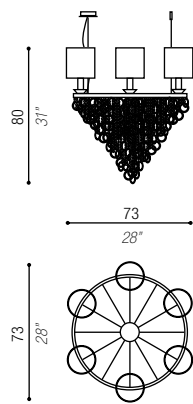

136/AP/3L

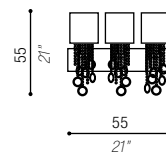

136/AP/2L

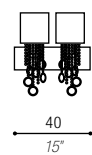

136/AP/1L

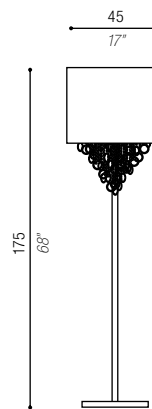
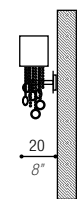
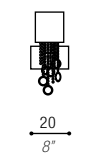

136/LTE/4L

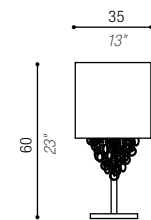

136/LTA/1L

versioni disponibili



legenda a pag. 159

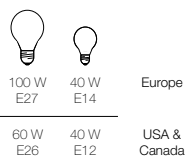



serie
series

121

Chanel

Un concetto giovane, design raffinato ma essenziale!

A young concept, refined but essential design!

Молодой концепция, рафинированные, но важно дизайн!

Struttura: ottone e parti in metallo

Diffusori: paralumi troncoconici in tessuto rigido bianco o nero

Decorazioni pendenti: gocce sfaccettate in cristallo Swarovski

Structure: brass and metal parts

Diffusers: conical lampshades fabric stiff white or black

Hanging decorations: faceted Swarovski crystal drops

Структура: латунь и металлические части

Докладчики: коническое абажуры ткань жесткая белые или черные

Висячие украшения: граненые хрустальные капли Swarovski



LUSTROGRAD
ОПТОВЫЕ ПРОДАЖИ СВЕТИЛЬНИКОВ

Disegni, dimensioni e varianti a pagina **143**





AIARDINI

142

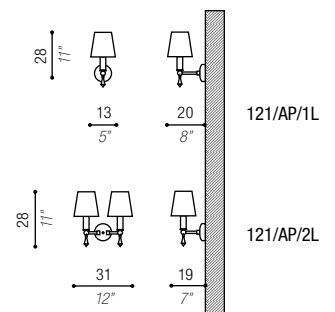
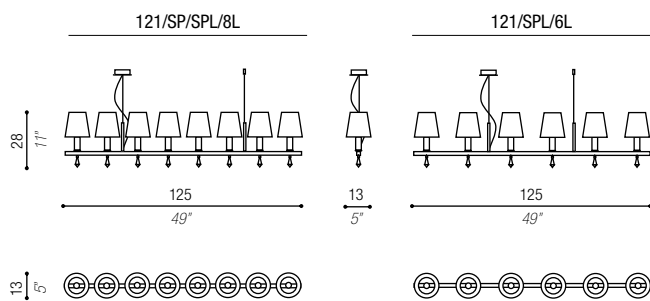
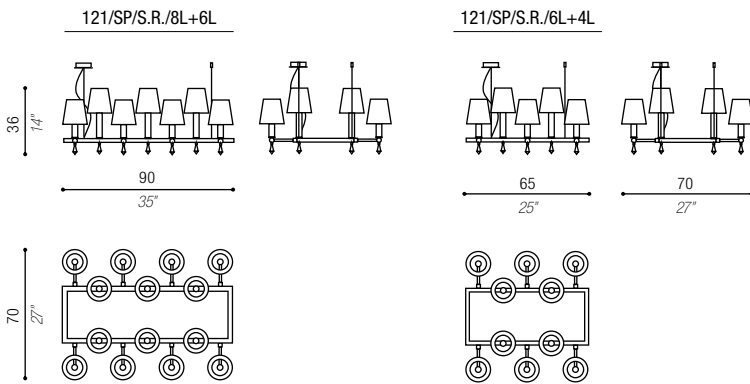
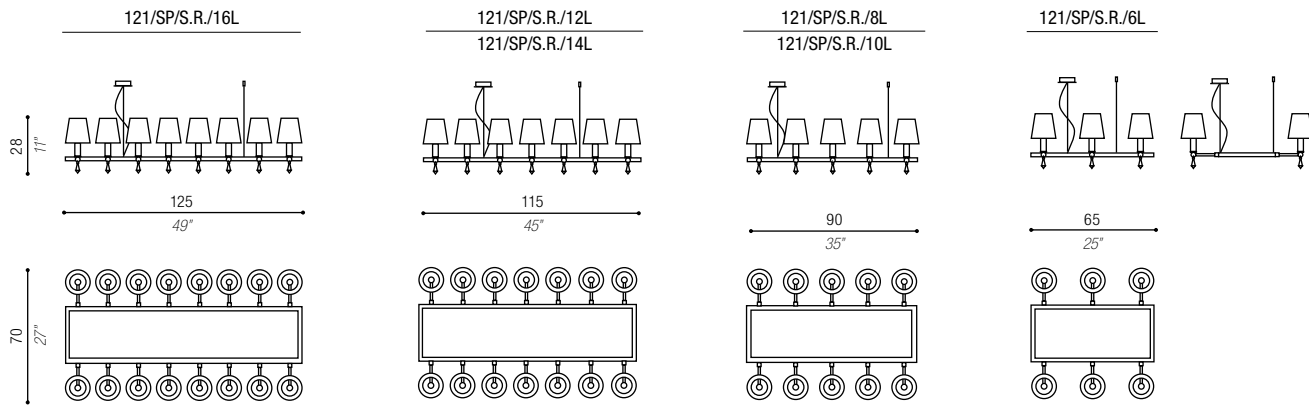

versioni disponibili



legenda a pag. 159

40 W E14 Europe
40 W E12 USA & Canada



serie
series

110

AIARDINI

144

Tango

una luce piena d'idee!
a full light of ideas!
свет, полон идей!

Struttura: ottone e parti in metallo, cucitura realizzata interamente a mano
Diffusori: vetro soffiato bianco lucido, lavorato a mano a Venezia
Decorazioni pendenti: gocce di vetro lavorate a mano a Venezia disponibili in bianco, nero oppure ambra

*Structure: brass and metal parts, sewing entirely made by hand
Diffuser: white blown glass hand made in Venice
Pendants decorations: venetian glass drops (white, black or amber)
Finishing: polished chrome or gold*

Структура: латунь и металлические части, швейные Полностью сделаны вручную
Рассеиватель: белое выдувное стекло ручной работы в Венеции
Подвески украшения: венецианское стекло капли (белый, черный или янтарь)
Отделка: полированный хром или золото

Disegni, dimensioni e varianti a pagina **151**





Tango





AIARDINI

148





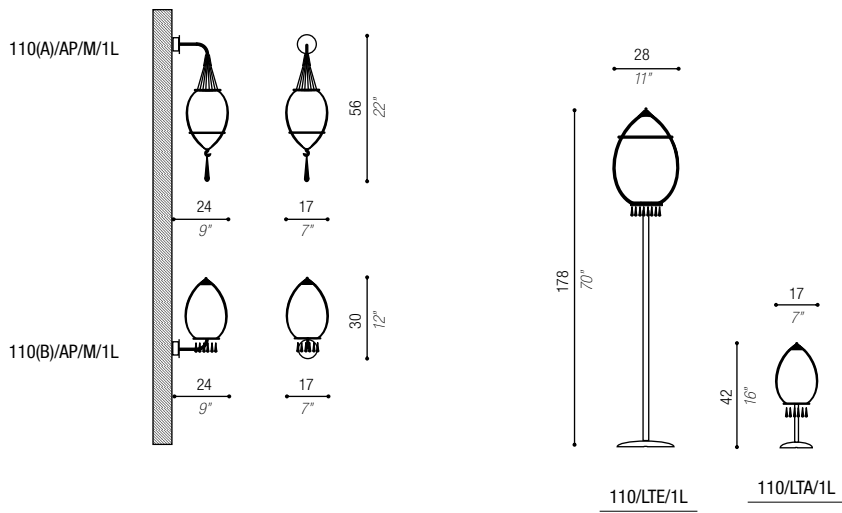
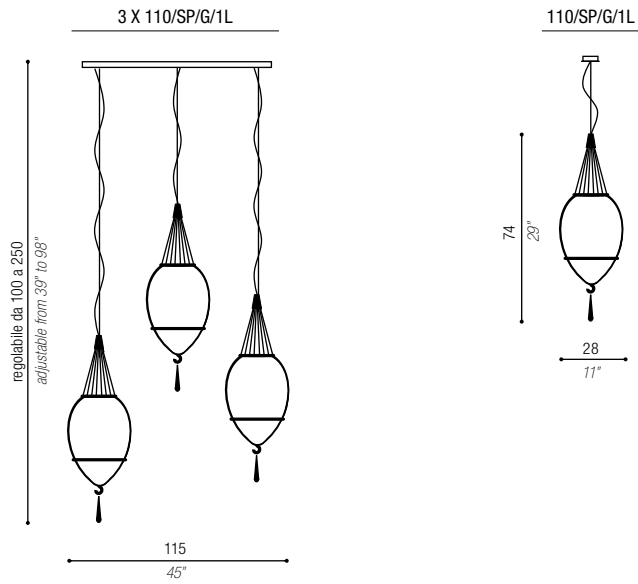

versioni disponibili



legenda a pag. 159

		Europe
100 W E27	40 W E14	
60 W E26	40 W E12	USA & Canada





serie
series

133

Melody

luci preziose nel vento!
precious lights in the wind!
драгоценные огни на ветру!

Struttura: ottone e parti in metallo
Decorazioni pendenti: catene di cristallo Swarovski
Finiture: cromo lucido, oro lucido, oro satinato, nichel satinato

*Structure: brass and metal parts
Decorations hanging chains Swarovski Crystal
Finishes: polished chrome, polished gold, satin gold, satin nickel*

Структура: латунь и металлические части
Подвески украшения: Swarovski Crystal цепи
Отделка: полированный хром, полированный золото, сатин золото, матовый никель

Disegni, dimensioni e varianti a pagina 157

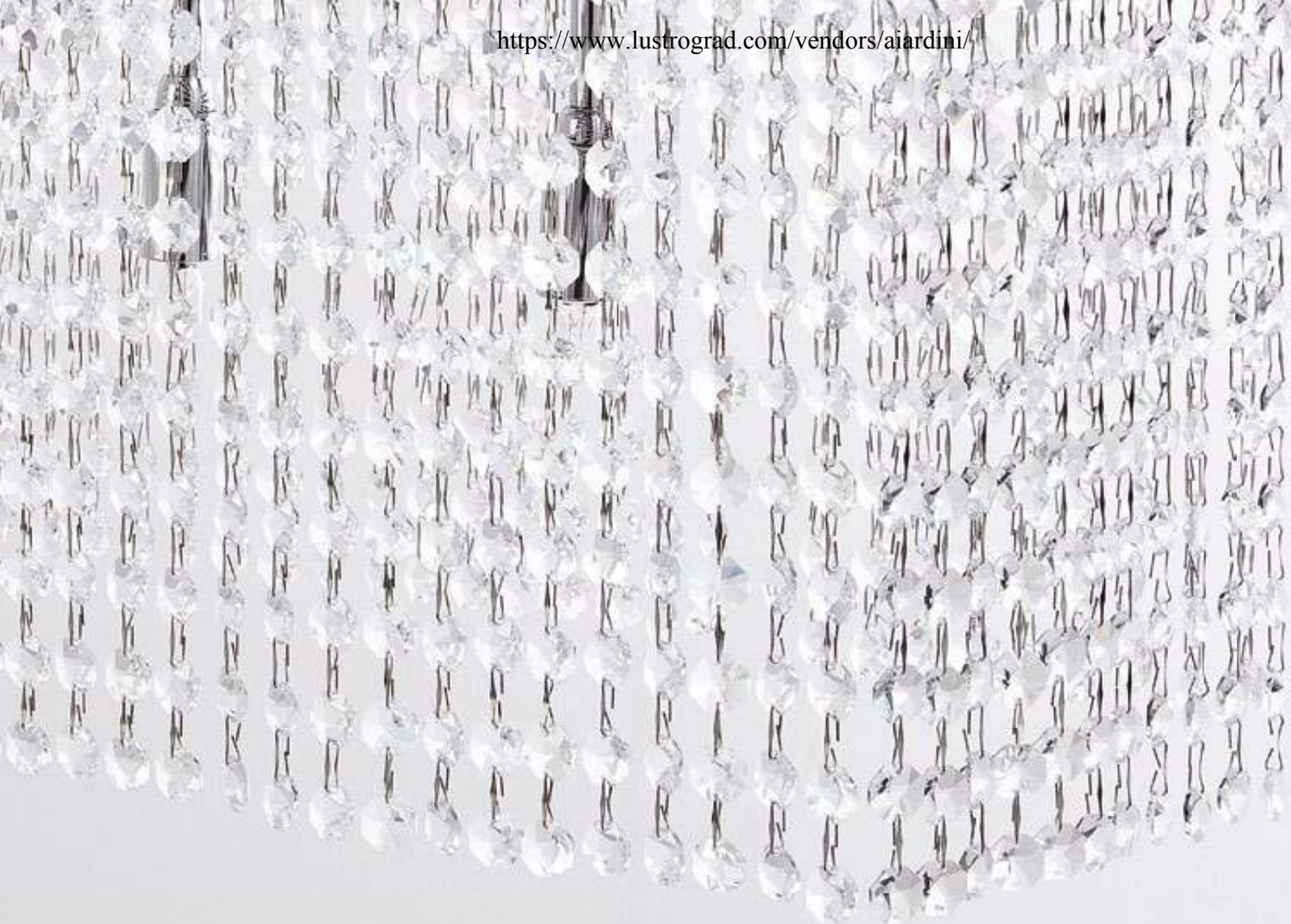

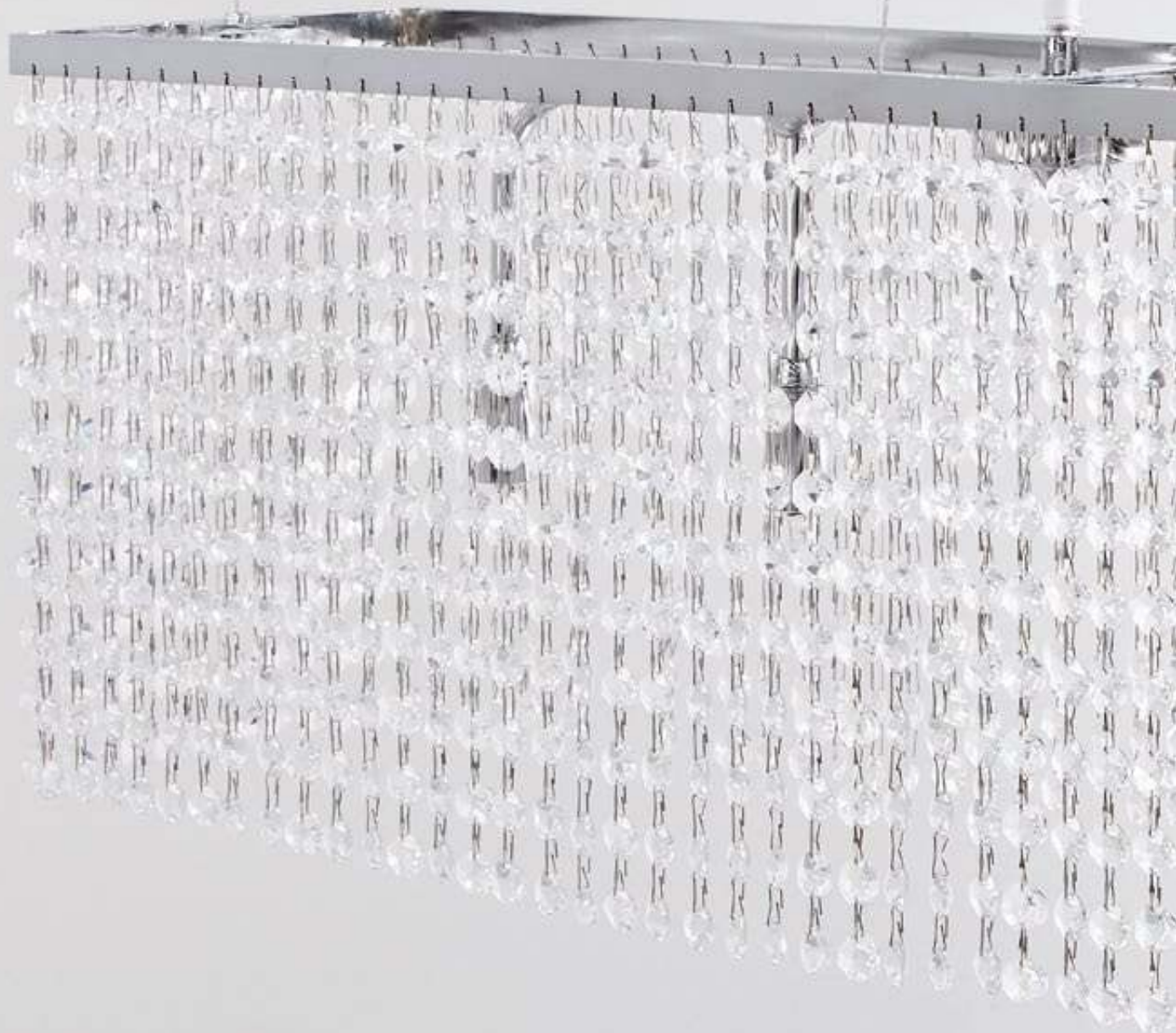

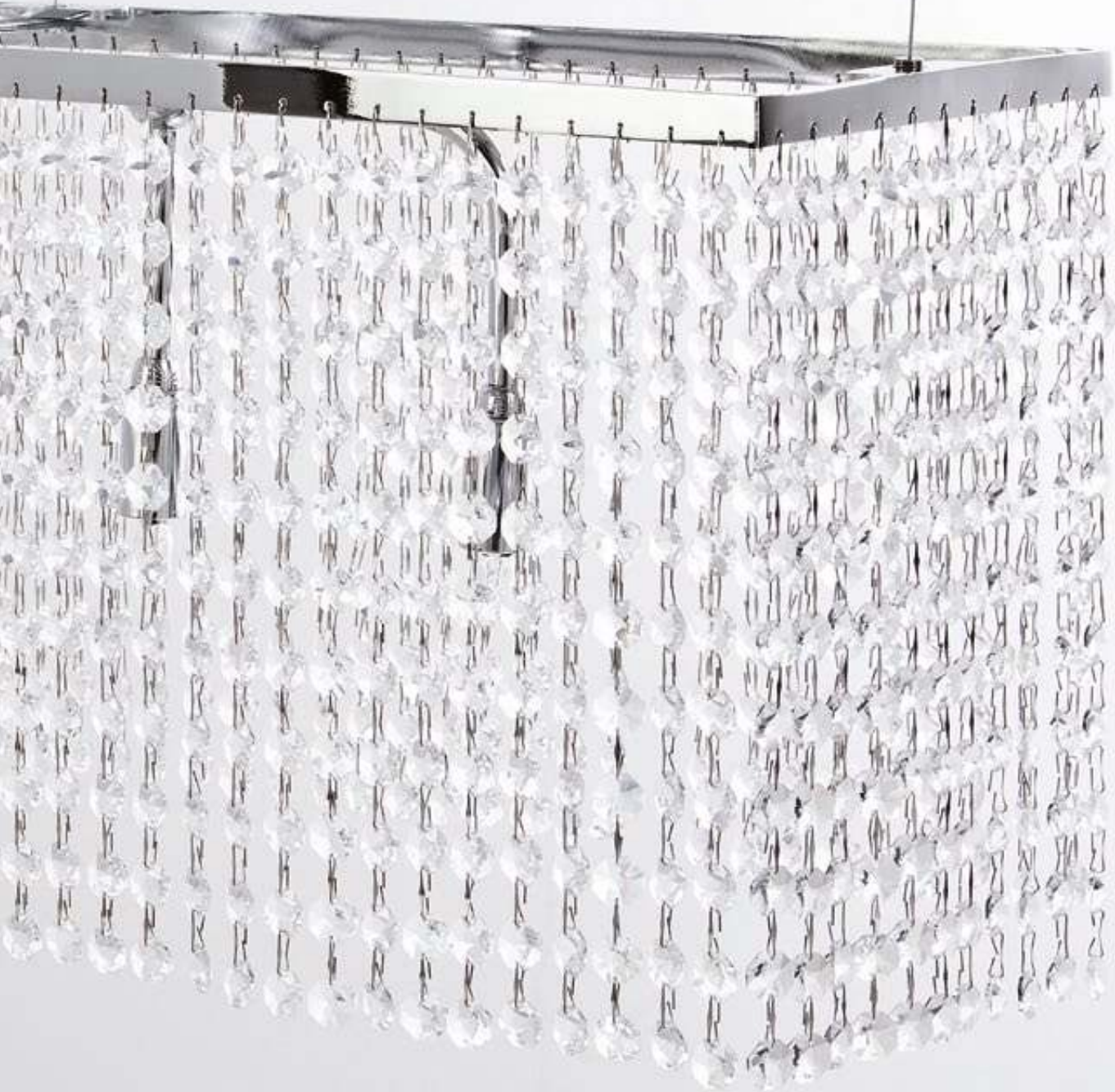



133/SP/120X40(H70)/24L

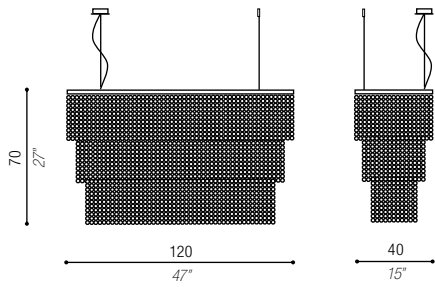

133/SP/40X40(H70)/10L

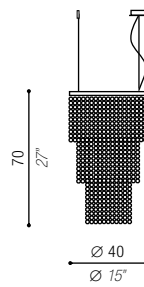

133/SP/120X30(H25)/10L

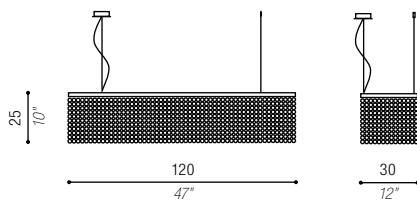

133/SP/100X30(H25)/8L

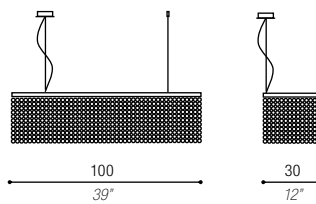

133/SP/80X30(H25)/6L

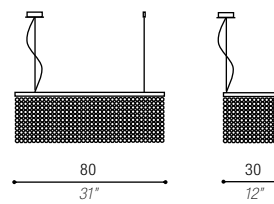

133/SP/15X15(H45)/1L

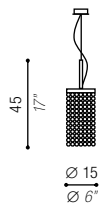

133/SP/25X25(H60)/3L

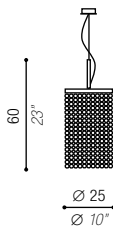

133/AP/1L
133/AP/2L
133/AP/3L

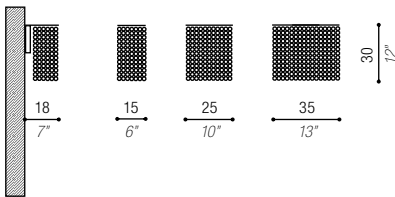

133/LTE/25X25(H160)/2L

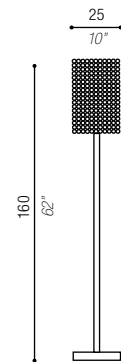

133/LTA/15X15(H35)/1L

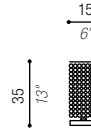



file 3D disponibili
available 3D files
3D-файлы доступны



sfera smerigliata E27
frosted sphere E27
матовое лампочка E27



sfera smerigliata E14
frosted sphere E14
матовое лампочка E14



sfera smerigliata E26
frosted sphere E26
матовое лампочка E26



sfera smerigliata E12
frosted sphere E12
матовое лампочка E12



alogeno bi-spina G9
halogen bi pin G9
галогенная Bi-Pin G9



LP
Lampadario
Chandelier
люстра



SP
Lampada a sospensione
Hanging lamp
Подвесной светильник



SPL
Sospensione lineare
Linear hanging lamps
линейные подвесные



LTE
Lampada da terra
Floor lamp
торшер



AP
Lampada a muro
Wall lamp
Настенные светильники



LTA
Lampada da tavolo
Table lamp
лампа настольная



sL
Struttura lineare
Linear structure
Линейная структура



sC
Struttura circolare
Circular structure
кольцевую структуру



sR
Struttura rettangolare
Rectangular structure
Прямоугольная структура



MA
I moduli di questa lampada possono essere assemblati anche su diversi livelli
The individual modules of this lamp can be assembled on multiple levels
Модули этой лампы может быть собран и на разных уровнях



H.r.
Altezza regolabile
Adjustable height
регулируемая по высоте



L'apposizione del marchio CE attesta che la lampada ha tutte le caratteristiche richieste dalla normativa europea EN 60598-1, che corrispondono alla normativa italiana CEI 34-21
The CE applied mark certifies that lighting fixture is in compliance with the standards required from the EN 60598-1 European regulations corresponding to CEI 34-21 Italian ones
Маркировка CE удостоверяет, что лампа имеет все функции, необходимые правилами. Европейский стандарт EN 60598-1, которые соответствуют действующим итальянским CEI 34-21



L'apposizione del marchio GOST R attesta che il prodotto risulta conforme ai requisiti degli standard russi Gost R - This certifies that the product is in conformity with the requirements laid down by the russian standards
Нанесение ГОСТ Р удостоверяет, что изделие соответствует требованиям российских стандартов



Indice di protezione dalla penetrazione nell'apparecchio di corpi solidi o liquidi
Protection index against solids or liquids entrance
Индекс защиты от проникновения в твердых или жидких веществ



L'apparecchio può essere installato su superfici normalmente infiammabili
The lighting fixtures can be installed on normal flammable surfaces
Устройство может быть установлено на легковоспламеняющихся поверхностях



In questo apparecchio possono essere installate lampadine fluorescenti a basso consumo energetico
In this lighting fixture can be installed energy-saving fluorescent lamps
Это устройство может быть установлено люминесцентные лампы с низким потреблением энергии



Questo apparecchio è dotato di lampadine alogene auto-protette (a bassa pressione)
This lighting fixture is equipped with self-shielded halogen lamps (low pressure)
Это светильник оснащен самозащитный галогенных ламп (низкий Pressure)



Marchio di conformità del prodotto ai requisiti di sicurezza canadesi e statunitensi
This listing Mark shows that the product is compliance with both Canadian and Us safety standards
Отметить этот список показывает, что продукт является compliance с обеих канадских и американских стандартов безопасности

graphic design
OHOHdesign.it

photographer
Giuseppe Matarazzo

Thanks to:
Vismara Design

AIARDINI®
MILANO

AIARDINI si riserva il diritto di modificare in qualsiasi momento e senza preavviso, caratteristiche tecniche ed estetiche degli oggetti presentati in questo catalogo l'unico miglioramento obiettivo.

AIARDINI reserves the right to change, at any time and without notice, the technical and aesthetic features of the items illustrated in this catalogue with the sole aim improvement.

AIARDINI оставляет за собой право изменять в любое время и без предварительного уведомления, технические и эстетические особенности предметов, представленные в этом каталоге с той лишь улучшению цели.

AIARDINI Illuminazione s.r.l.
via Gaspare Gozzi, 8
20129 Milano · Italy
UFFICIO COMMERCIALE ITALIA
ph. > 800 92 62 62
EXPORT DEPARTMENT
ph. > +39 081 81 89 125
www.aiardini.it · info@aiardini.it

LUSTRO GRAD
ОПТОВЫЕ ПРОДАЖИ СВЕТИЛЬНИКОВ