



Quality is not an act;

It is a habit.

(Aristotle 384 - 322 B.C.)

FOLD P 6-15

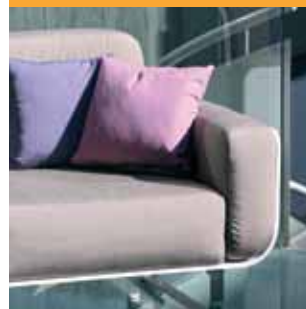

MIXT P 162-167



ZIDIZ P 16-23



NINIX P 64-107

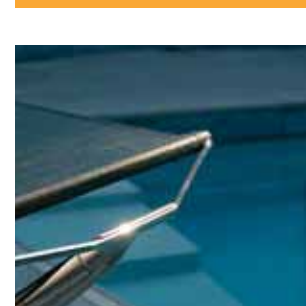

NEW ENGLAND P 168-173



LAZY P 210-219



WAVE/SURF P 24-33



EZ P 108-113



VIGOR P 174-179



QT / TABOELA SEXION P 220-233

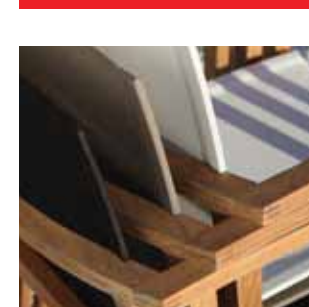

O-ZON P 34-51



SOLID P 114-133

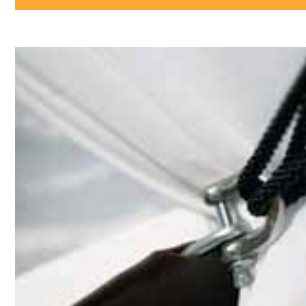

ALURA P 182-199



XQI / BEACHER P 234-247

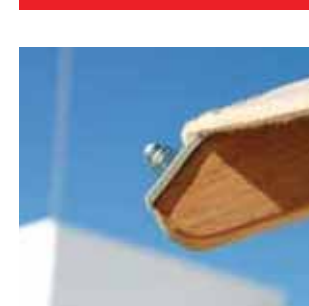

D-LUX P 52-63



KOKOON P 134-139

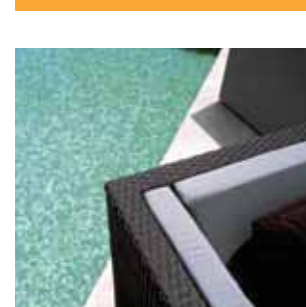

LITTLE-L P 200-209



UMBRELLAS P 248-261

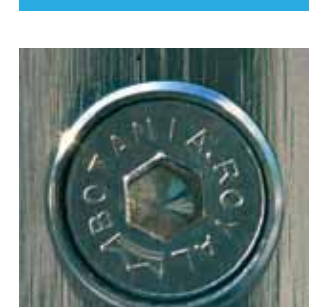

SUNDAY P 140-161

SPECS P 262-320

Your leisure, our pleasure

FOR DEVOTEES OF AESTHETIC REFINEMENT our dedicated team has created a line of exceptional outdoor furniture. The successful blend of precision and functionality is aimed at fulfilling each and every wish of our privileged customers. Indeed your leisure is our pleasure... POUR LES ADEPTES DE L'ESTHÉTISME, notre équipe a créé une ligne exceptionnelle de mobilier de jardin. Un savant mélange de précision et de fonctionnalité vise à satisfaire chacun des désirs de nos clients. En effet votre loisir est notre plaisir. FÜR BEGEISTERTE ANHÄNGER DER ÄSTHETISCHEN VEREDELUNG hat unser engagiertes Team eine Linie außergewöhnlicher Gartenmöbel kreiert. Die erfolgreiche Mischung aus Präzision und Funktionalität ist auf die Erfüllung jedes einzelnen Wunsches unserer privilegierten Kunden ausgerichtet. In der Tat, Ihre Freizeit ist unser Vergnügen. VOOR LIEFHEBBERS VAN ESTHETISCHE VERFIJNING, heeft ons toegewijd team een collectie uitzonderlijke buitenmeubelen gecreëerd. De succesvolle samensmelting van precisie en functionaliteit is gericht op het vervullen van iedere wens van ons geprivilegeerd clientele. Inderdaad uw vrije tijd is onze passie... PER GLI AFFEZIONATI DELLA PERFEZIONE ESTETICA abbiamo creato una linea di mobili da giardino eccezionali. La riuscita miscela di precisione e funzionalità è finalizzata a soddisfare ogni singolo desiderio della nostra privilegiata clientela. Il Vostro tempo libero è la nostra passione. PARA LOS MÁS EXIGENTES EN CUANTO AL DISEÑO, nuestro equipo ha creado una línea excepcional de muebles de exterior. La lograda mezcla entre precisión y funcionalidad va dirigida a cumplir cada uno de los deseos más exigentes de nuestros privilegiados clientes. Efectivamente, su ocio es nuestra dedicación.

OUTDOOR LUXURY



A MARRIAGE between contemporary materials and a 60's design, this is what FOLD is all about. The seat made of carefully shaped and bent acrylic or aluminium plates nicely complements its shiny electro-polished stainless steel base. The different elements can be joined in numerous combinations, allowing you to be creative with the lay-out of the lounge corner of your dreams. Now just throw in the deluxe cushions and invite your friends for a drink... **UN MARIAGE** de matériaux contemporains et de looks des années soixante, voilà comment résumer FOLD. L'assise baquet réalisée en plaque d'acrylate ou aluminium courbée contraste magnifiquement avec le piétement brillant en acier inoxydable électropoli. Les innombrables possibilités de combinaison vous permettent d'être créatif dans la composition du coin salon de vos rêves. Il ne vous reste plus qu'à ajouter des coussins et inviter vos amis à venir passer du bon temps eux aussi... **FOLD STEHT** für eine Kombination moderner Materialien und Looks aus den Sixties. Die aus einer gebogener Acrylat- oder Aluminiumplatte bestehende Sitzschale kontrastiert perfekt mit dem glänzenden Gestell aus elektropoliertem Edelstahl. Zahllose Kombinationsmöglichkeiten ermöglichen ihnen bei der Zusammenstellung der Lounge-Ecke Ihrer Träume kreativ zu sein. Sie müssen lediglich noch die Kissen hineinwerfen und Ihre Freunde zum Genießen einladen... **EEN HUWELIJK** tussen eigentijdse materialen en looks uit de sixties, dat is waar FOLD voor staat. De zitkuip vervaardigd uit gebogen acrylaat- of aluminiumplaat, steekt prachtig af tegen het glanzende onderstel uit geëlektropolijst RVS. Ontelbare combinatiemogelijkheden laten u toe, creatief te zijn bij het samenstellen van de lounge hoek van uw dromen. Nu enkel de kussens er nog ingooien en uw vrienden uitnodigen om mee te komen genieten... **UN CONNUBIO** fra materiali contemporanei e design anni Sessanta: ecco cos'è FOLD. La seduta ottenuta da un pannello curvato in acrilico o alluminio risalta magnificamente sul brillante telaio in acciaio inox con finitura elettrolitica. Infinite possibili combinazioni vi consentiranno di liberare la vostra creatività per comporre l'angolo relax dei vostri sogni. E una volta aggiunti i cuscini, non vi resta che invitare qualche amico a trascorrere piacevoli momenti in compagnia... **LA UNIÓN** entre los materiales contemporáneos y un diseño de los años 60, así podríamos describir FOLD. La silla, realizada con planchas acrílicas o aluminio cuidadosamente curvadas y formadas, se complementa con su base de acero inoxidable electropulido de acabado brillante. Los diferentes elementos pueden aliarse en numerosas combinaciones, permitiéndole dar rienda suelta a su creatividad a la hora de diseñar el salón de sus sueños. Tan sólo déjese caer sobre unos cojines deluxe e invite a sus amigos a una copa...

FOLD



Design: Frank Boschman



FOLD



FOLD

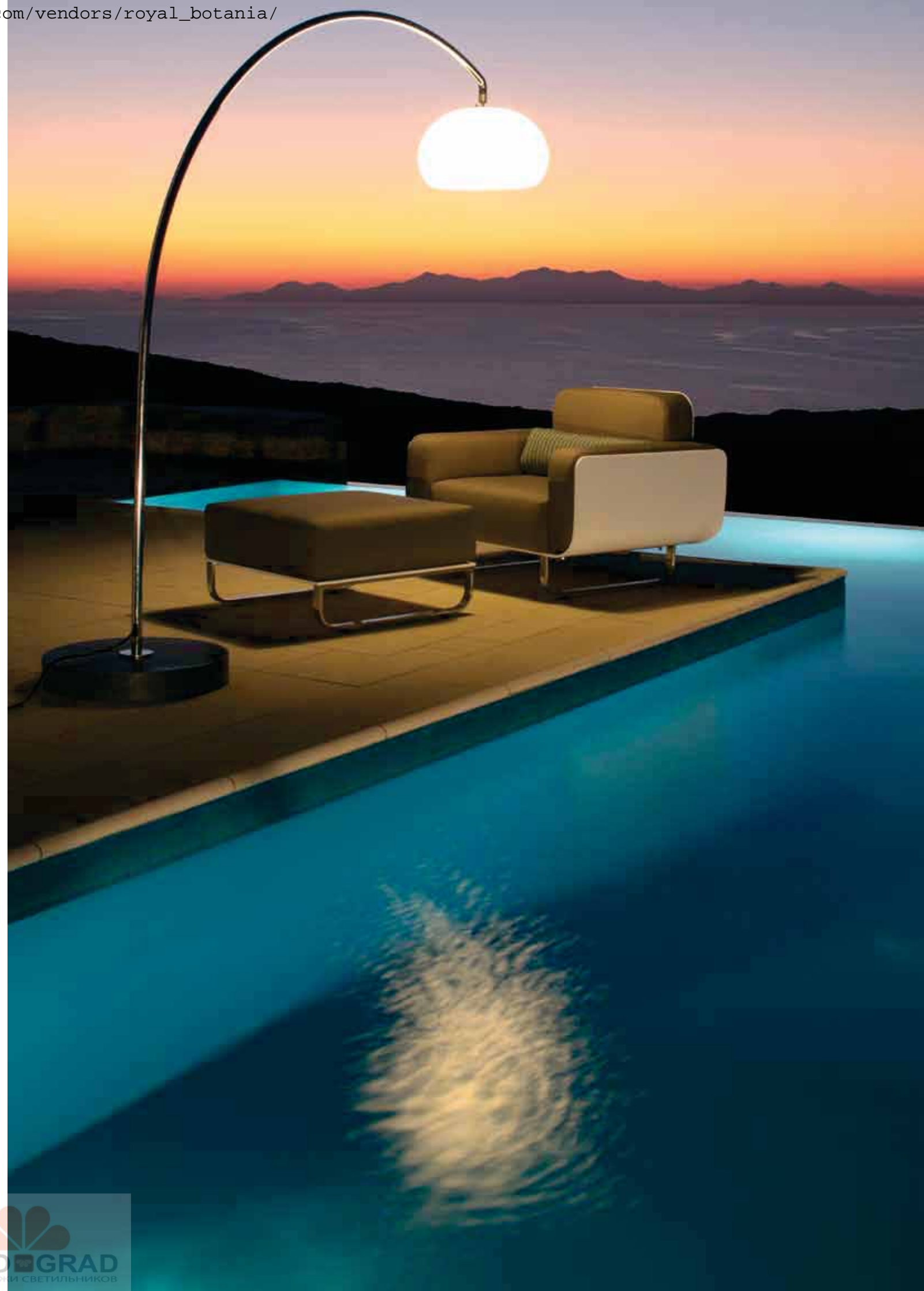



A THIN ALUMINIUM SHEET, SHAPED INTO A MINIMALISTIC SEAT to be hung into a warm organically shaped teak frame, doesn't sound like a perfect marriage. But ZIDIZ proves that it does look like one! When placing the stackable chairs around a matching table frame with a smoothly curved Corian® or glass top, you will find them even more appealing. UN SIÈGE MINIMALISTE ET FIN EN ALUMINIUM, doté d'un cadre ergonomique en teck pour une association parfaite. Lorsque les chaises empilables sont placées autour de la table au plateau soit lisse en Corian arrondi, soit en verre blanc, cette collection est des plus séduisantes. DÜNNES ALUMINIUMBLECH, GEFORMT ZU EINEM MINIMALISTISCHEN SITZ, eingehängt in einen warmen, organisch geformten Teakholzrahmen klingt so gar nicht nach einer perfekten Kombination. Aber ZIDIZ beweist, dass es doch möglich ist! Wenn die stapelbaren Stühle dann noch um einen passenden Tischrahmen mit sanft gewölbten Corian® oder einer Glasoberfläche platziert sind, wird man sie nur noch reizvoller finden. EEN DUNNE ALUMINIUM PLAAT, GEVORMD TOT ZITTING, opgehangen in een warm, organisch gevormd, teakhouten frame, klinkt niet echt als een perfect huwelijk. ZIDIZ bewijst het tegendeel! Wanneer je deze stapelbare stoelen rond de bijhorende tafel, met zachte contouren plaatst ben je helemaal overtuigd! UNA SEDUTA MINIMALISTICA REALIZZATA CON UNA SOTTILE LASTRA DI ALLUMINIO appesa a un telaio in teak dalle forme organiche non si direbbe il connubio perfetto ... ma in realtà è così, lo testimonia Zidiz! Abbinando poi queste sedie impilabili al tavolo coordinato (con piano in Corian® o in vetro e il perimetro dolcemente sagomato), le troverete ancora più attraenti. UNA HOJA DELGADA DE ALUMINIO EN FORMA DE ASIENTO MINIMALISTA SITUADO en un marco orgánico de teca, no parece el matrimonio perfecto. Sin embargo, ¡ZIDIZ demuestra que en realidad sí lo es! Si además, colocamos las sillas apilables en una mesa a conjunto con una sutil curva Corian® o una superficie de cristal, resultan todavía más atractivas.

ZIDIZ



Design: Kris Van Puyvelde





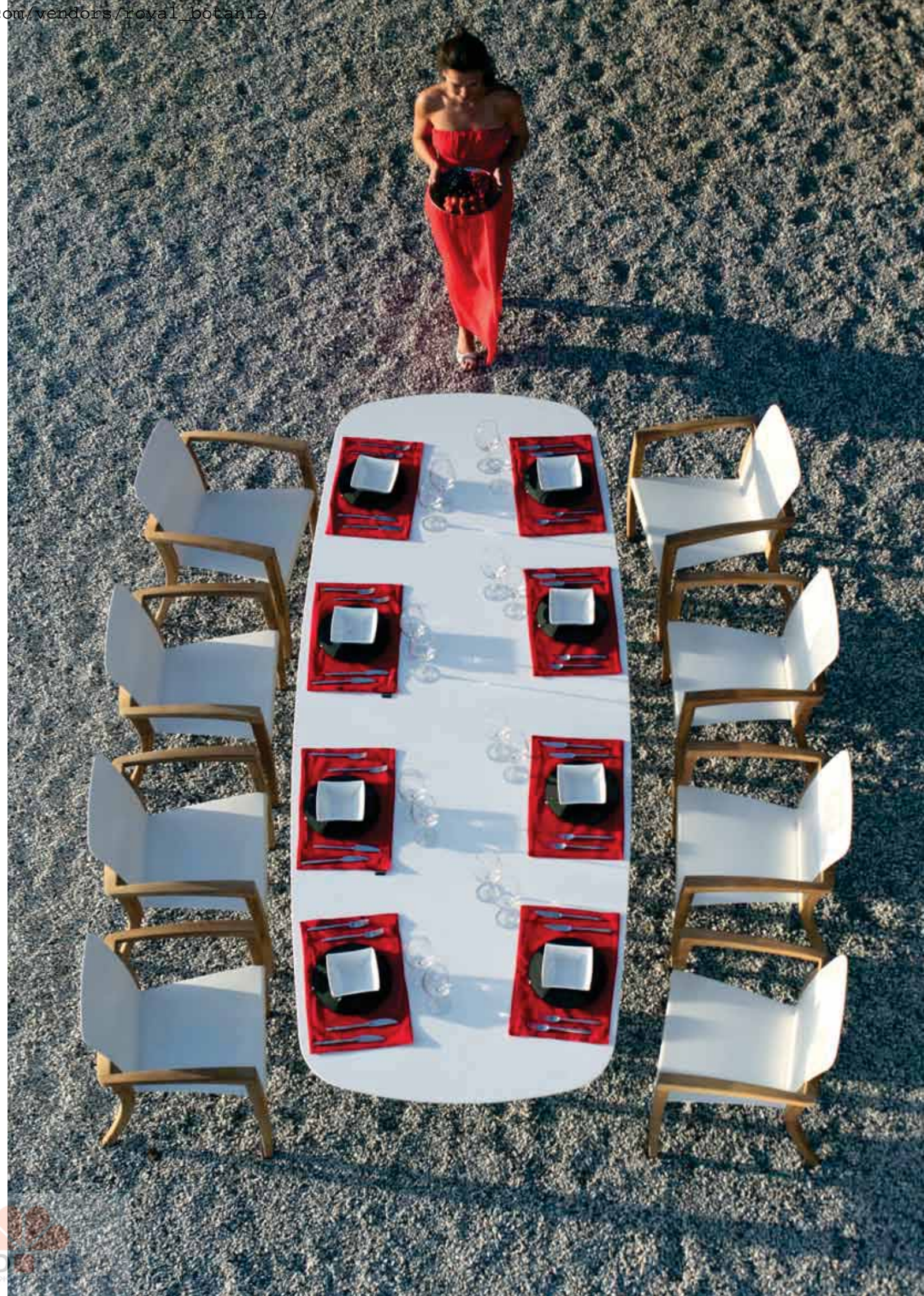

WAVE/SURF

LEAVE YOUR TROUBLES BEHIND, and be overwhelmed by a wave of wellness, hovering halfway between heaven and earth, while simply doing nothing... OUBLIEZ VOS SOUCIS et laissez-vous porter par une vague de bien-être, à mi-chemin entre la Terre et le Ciel pendant vos moments d'oisiveté... LASSEN SIE IHRE SORGEN HINTER SICH und lassen Sie sich von einer Welle des Wohlbefindens überwältigen, schwebend auf halbem Weg zwischen Himmel und Erde, einfach mal nichts tun... VERGEET UW ZORGEN en laat uzelf overspoelen door een golf van goed gevoel, zwevend halfweg tussen hemel en aarde, terwijl u lekker niets doet... DIMENTICATEVI DEI VOSTRI PROBLEMI, e lasciatevi sopraffare da un'onda di benessere, metà tra cielo e terra, nel relax più totale... DEJA TUS PROBLEMAS ATRÁS, y déjate llevar por una ola de wellness, flotando entre el cielo y la tierra, mientras estas simplemente no haciendo nada...



Design: Erik Nyberg & Gustav Ström & Kris Van Puyvelde



Be overwhelmed,

by a WAVE of wellness...

WAVE



Aegina

Greece

10.45 am 24°C

SURF

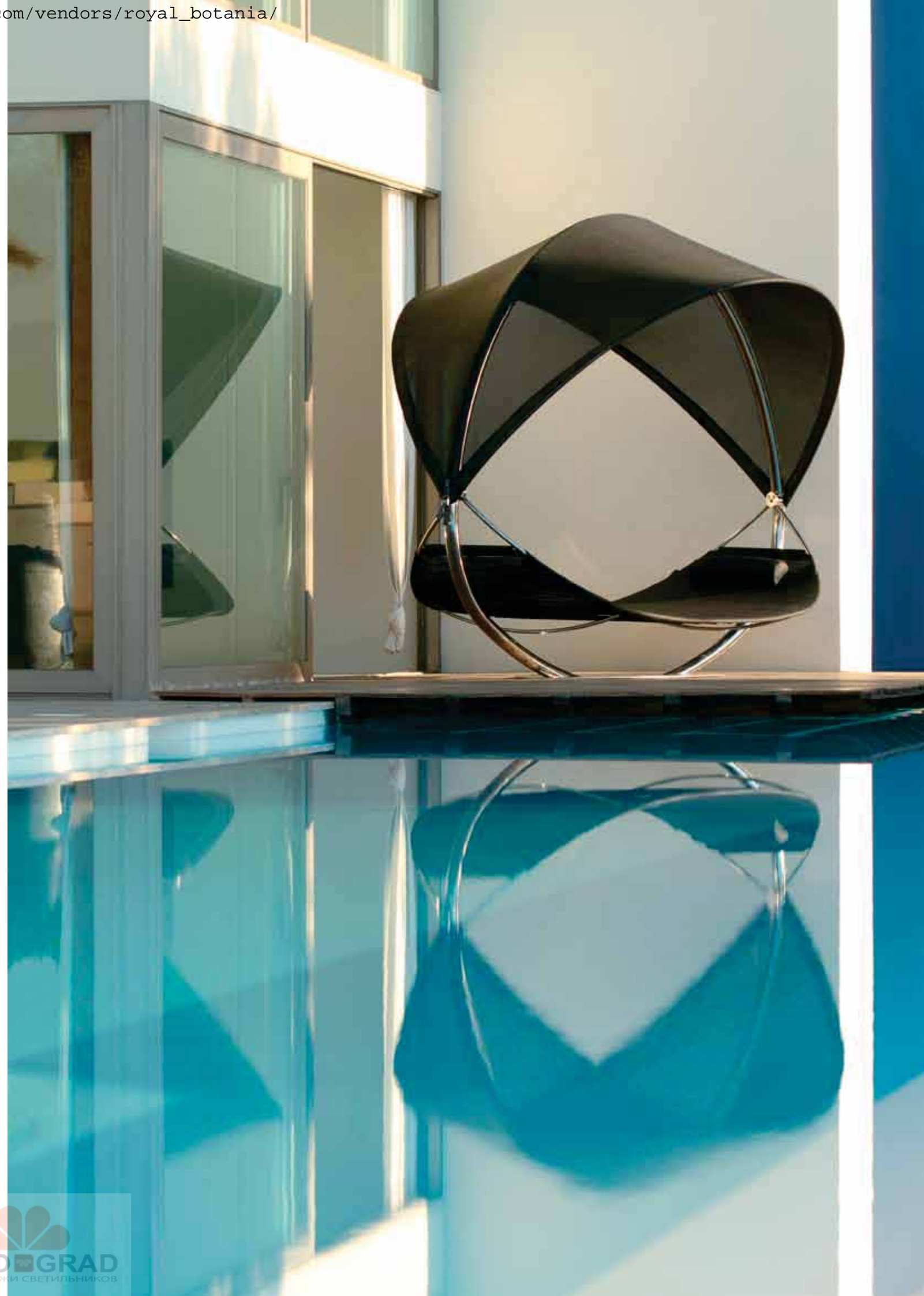



*... hovering halfway between
heaven and earth!*

0 - Z O N

LOOK UP AT THE SUN, and you will realise where we got our inspiration for the 0-ZON range. When struck by its blinding appearance, just put on your sunglasses. **SCHAUEN SIE ZUR SONNE** und Sie werden erkennen, woher wir unsere Inspiration für die Linie 0-ZON bekommen haben. Sollte Sie diese Erscheinung blenden, setzen Sie einfach Ihre Sonnenbrille auf. **REGARDEZ LE SOLEIL** et vous réaliserez où nous avons puisé notre inspiration pour la collection 0-ZON. Si vous êtes aveuglé par ses lignes, alors mettez vos lunettes. **AANSCHOUW DE ZON** en u zult begrijpen waar we onze inspiratie vonden voor de 0-ZON reeks. Als u perplex staat door haar verblindende presence, zet dan gewoon uw zonnebril op! **GUARDATE IL SOLE** e capirete da dove abbiamo preso l'ispirazione per la linea 0-ZON. Se siete colpiti dal suo aspetto accecante indossate gli occhiali da sole. **MIRE HACIA EL SOL** y sabrá en que nos hemos inspirado para la serie 0-ZON. Cuando se ciege por su deslumbrante apariencia, simplemente póngase sus gafas de sol.



Design : Kris Van Puyvelde



Mediterranean Sea

11.15 am 27°c

0 - ZON



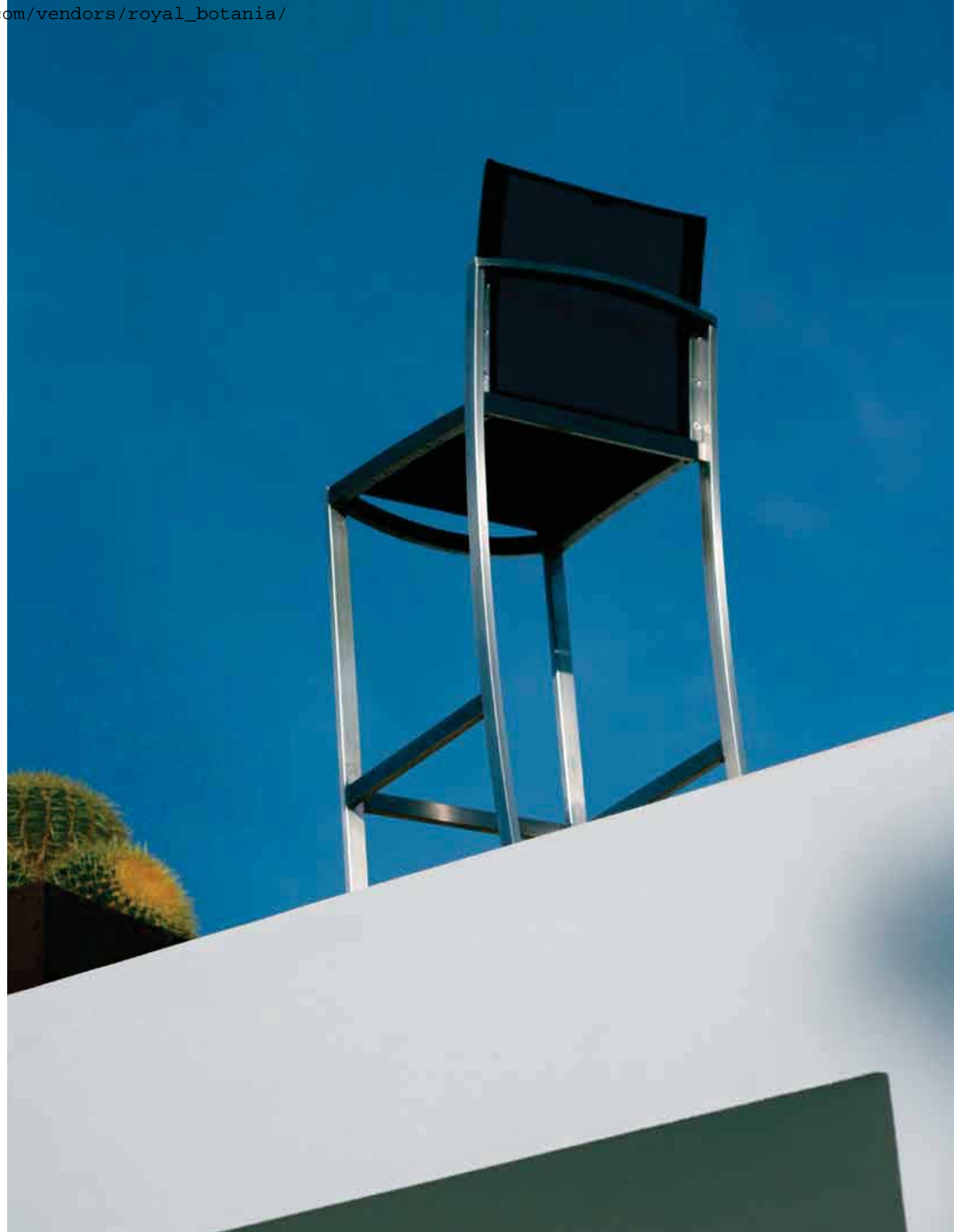



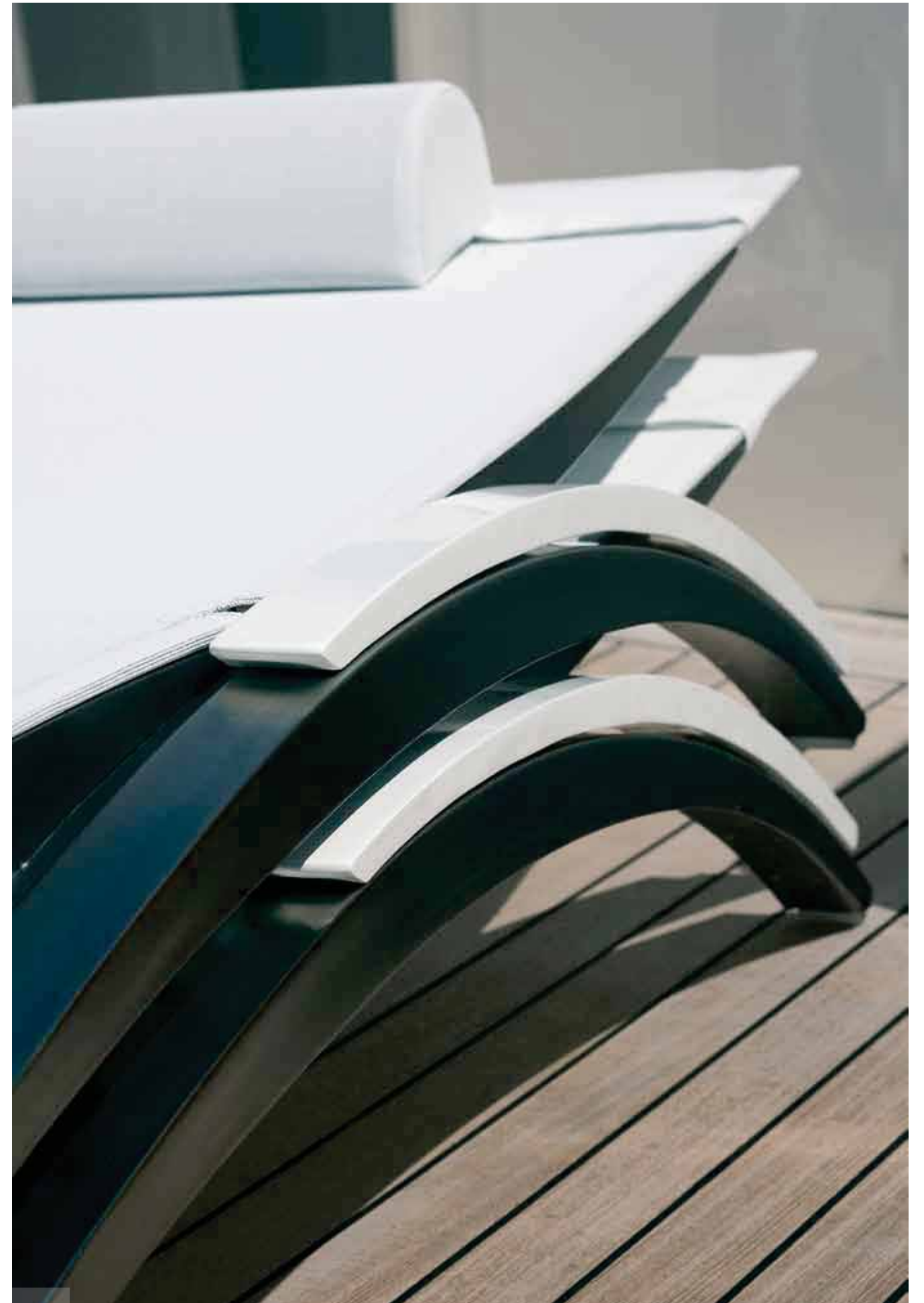



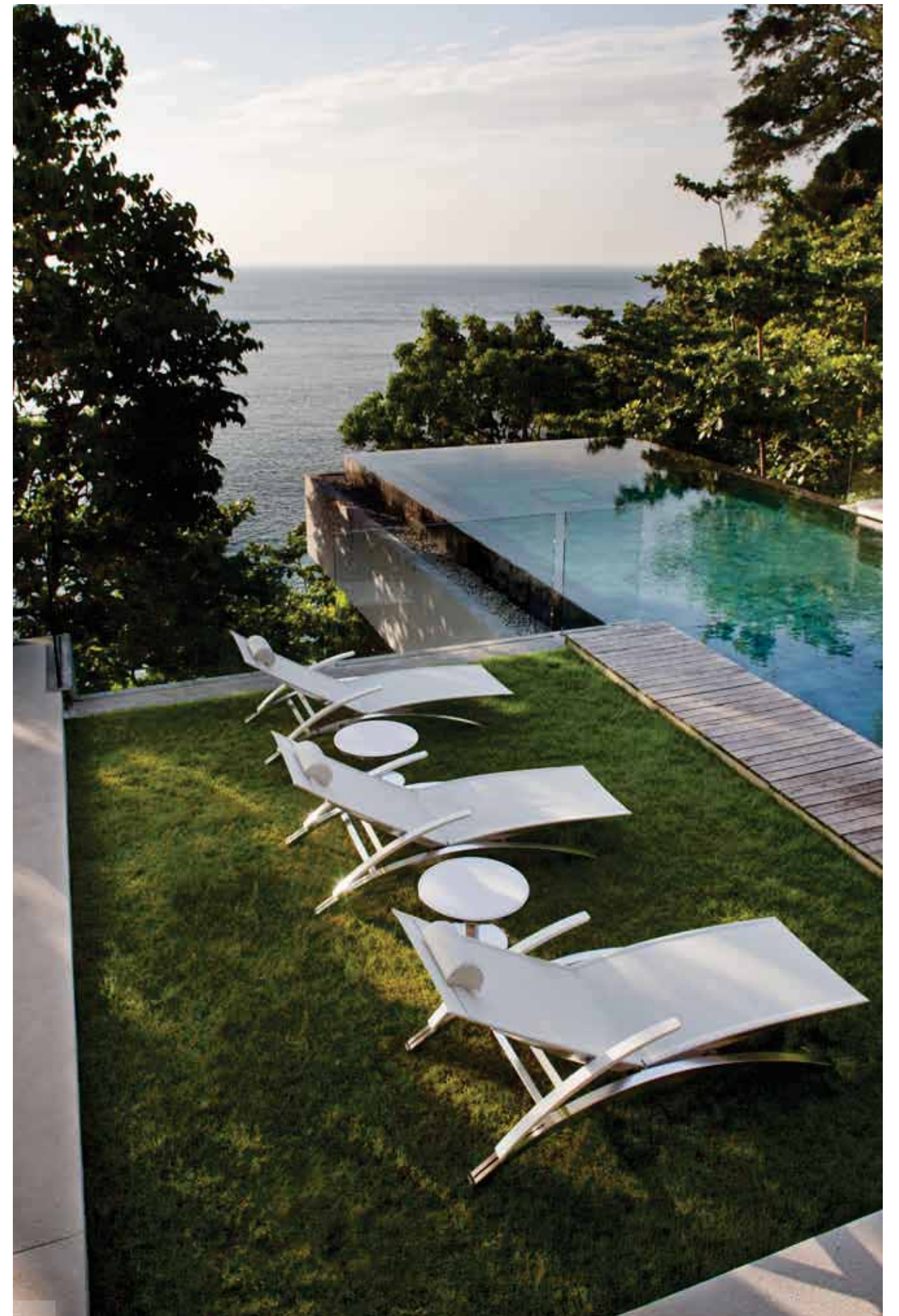

0 - Z O N



Amanzi Thailand 6.15 pm 26°C

STRAIGHT MINIMALIST lines are known to result in pure shapes. Therefore achieving purity in design, working with female curves, and convex- or concave surfaces, is much more of a challenge. This exercise gets even more complex when the outcome not only needs to look sleek but also needs to provide optimal ergonomics and comfort. Nevertheless, all these requirements have been met by cutting and forming aluminium plates into these exceptionally beautiful shapes that are so typical of D-LUX. Indeed, the word 'ordinary' simply does not feature in a description of D-LUX furniture.

TOUT LE MONDE SAIT que des lignes droites minimalistes génèrent des concepts aux looks épurés. C'est précisément pourquoi réussir à obtenir un design épuré en combinant de douces rondeurs féminines avec des plans convexes et concaves représente un important défi. Cette mission devient encore plus complexe si on ne vise pas seulement un objet agréable à regarder, mais aussi ergonomique et confortable. Néanmoins, tous ces objectifs sont atteints grâce à la découpe et au façonnage ingénieux de tôles en aluminium pour arriver aux formes extraordinaires qui caractérisent le D-LUX. Ne parlez donc jamais d'un D-LUX comme d'un simple meuble.

ES IST ALLGEMEIN BEKANNT, dass gerade, minimalistische Linien pur aussehende Objekte ergeben. Gerade darum ist das Erreichen von Reinheit im Design durch Kombination weicher, weiblicher Rundungen mit konvexen und konkaven Flächen eine Herausforderung. Die Aufgabe wird noch komplexer, wenn man nicht nur nach einer Augenweide strebt, sondern auch nach Ergonomie und Komfort. Und doch werden all diese Ziele durch geschicktes Schneiden und Formen von Aluminiumplatten zu den außerordentlichen Formen, die den D-LUX charakterisieren, erreicht. Nennen Sie einen D-LUX also nie einfach ein Möbelstück.

HET IS ALGEMEEN GEWETEN dat rechte minimalistische lijnen leiden tot puur ogende ontwerpen. Net daarom is het bereiken van puurheid in design, door het combineren van zachte vrouwelijke rondingen met convexe- en concave vlakken, des te meer een uitdaging. Die opgave wordt nog complexer, als niet enkel gestreefd wordt naar het strelen van de ogen, maar ook naar ergonomie en comfort. Toch worden al deze doelen bereikt door het kunstig snijden en vormen van aluminium plaatwerk tot de uitzonderlijke vormen die de D-LUX karakteriseren. Dus gelieve een D-LUX dus nooit zomaar een meubel te noemen.

È RISAPUTO CHE il minimalismo delle linee rette dà vita ad oggetti dalle forme pure. Proprio per questo, quindi, cercare di raggiungere la purezza nel design, laddove si mescolano morbide rotondità femminili e superfici concave e convesse, è una sfida persino più ambiziosa. Il compito si complica ulteriormente se, oltre a creare un articolo che sia un piacere per gli occhi, si cerca anche di ottenere ergonomia e comfort. Tutti questi obiettivi, comunque, sono stati raggiunti tagliando e modellando abilmente lastre di alluminio fino a trasformarle nelle forme esclusive che caratterizzano D-LUX. Pertanto, ricordate sempre: D-LUX non è semplicemente un mobile.

LAS LÍNEAS MINIMALISTAS rectas derivan en formas definitivamente puras. Por lo tanto, lograr la pureza en el diseño, trabajar con curvas femeninas y con superficies cóncavas o convexas, supone mucho más que un reto. Este ejercicio resulta mucho más complejo cuando el resultado no solamente requiere un aspecto pulcro, sino que además debe ofrecer una ergonomía y un confort óptimos. Aún así, todos estos requisitos se lograron cortando y conformando planchas de aluminio con estas formas excepcionales y sorprendes, haciendo de D-LUX un elemento cómodo y atractivo.

D - LUX



Design: Kris Van Puyvelde

D - LUX



D - L U X





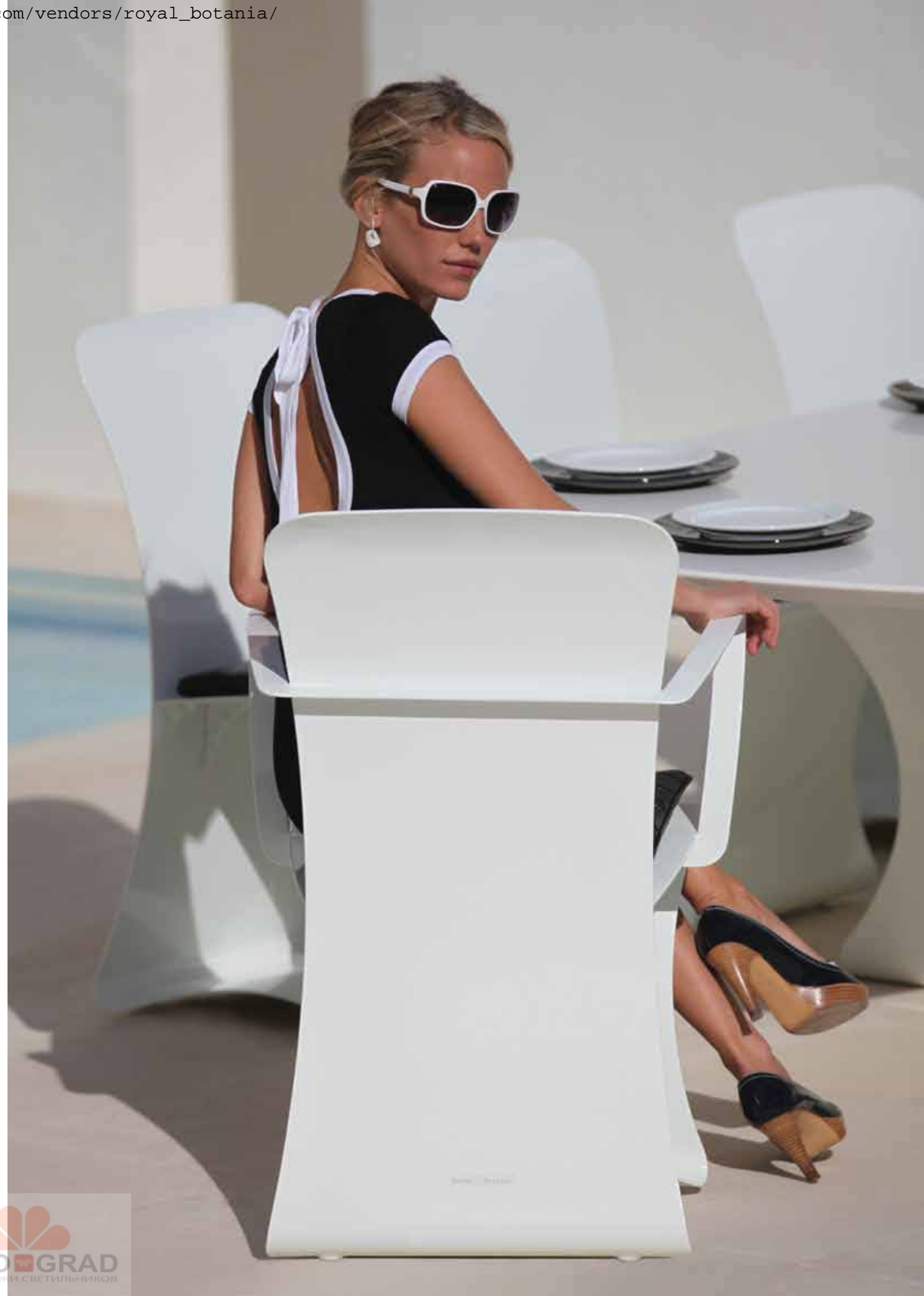



NINIX MEANS BOTH minimal and maximal. A Contradiction? Not if you know that in material selection, comfort, and refinement, the maximum is being offered. The hairline finish of the stainless steel frame, the woodwork in carefully selected teak, it's optimized ergonomics,... The minimum relates to the lines of the design. Almost a pity to use outdoors...NINIX SYMBOLISE À LA FOIS le minimal et le maximal. Une contradiction? Non, si vous attendez d'un meuble, confort et raffinement, le maximum doit être offert : finition pure de la structure en acier inoxydable, délicat travail d'un teck parfaitement sélectionné, excellence de son ergonomie. Le minimum est relatif à son design. NINIX, c'est le minimal et le maximal qui fluctue de l'extérieur vers l'intérieur. NINIX SOLL BEIDES VEREINEN: Minimal und Maximal. Ein Widerspruch glauben Sie? Nicht wenn Sie sich vergegenwärtigen, dass die Materialauswahl, der Sitz-Komfort und die Verarbeitung höchsten Standards genügen sollen! Das feine Finish des Edelstahl-Gestells, die Holzarbeiten aus sorgfältig selektiertem Teak, die optimale Ergonomie. Der Minimalismus liegt in der Formgebung des Designs. Beinahe eine Schmach, diese Möbel im Freien zu verwenden... NINIX BETEKENT ZOWEL minimaal als maximaal. Contradictorisch? Niet als u weet dat qua materiaalkeuze, qua comfort en qua verfijning het maximum wordt geboden: het nauwkeurig geslepen roestvrijstalen frame, het houtwerk in zorgvuldig geselecteerd volgroeid teakhout met zijn geoptimaliseerde ergonomische vormgeving. Het minimum als we het lijnenspel bekijken. Bijna zonde om enkel buiten te gebruiken..... NINIX SIGNIFICA minimale e massimale. Una contraddizione ? No, se sai che nella selezione del materiale, comfort e raffinatezza, è offerto il massimo. La perfetta finitura della struttura in acciaio inossidabile, la lavorazione del legno di teak selezionato attentamente, l'ergonomia ottimalizzata. Minimale si riferisce alle linee del disegno. Quasi un peccato usarli fuori casa... NINIX SIGNIFICA LAS DOS COSAS "minimal" y "maximal." ¿Una contradicción? No, si conoces que en la selección de material, confort y refinamiento, se alcanza el máximo. El exquisito acabado de la estructura de acero inoxidable, el acabado de la madera en teca cuidadosamente seleccionada, su ergonomía optimizada. El "minimal" se refiere a su diseño. Una pena usarla sólo para exterior...

N I N I X



Design : Kris Van Puyvelde







Amanzi Thailand 10.15 am 26°C















NINIX



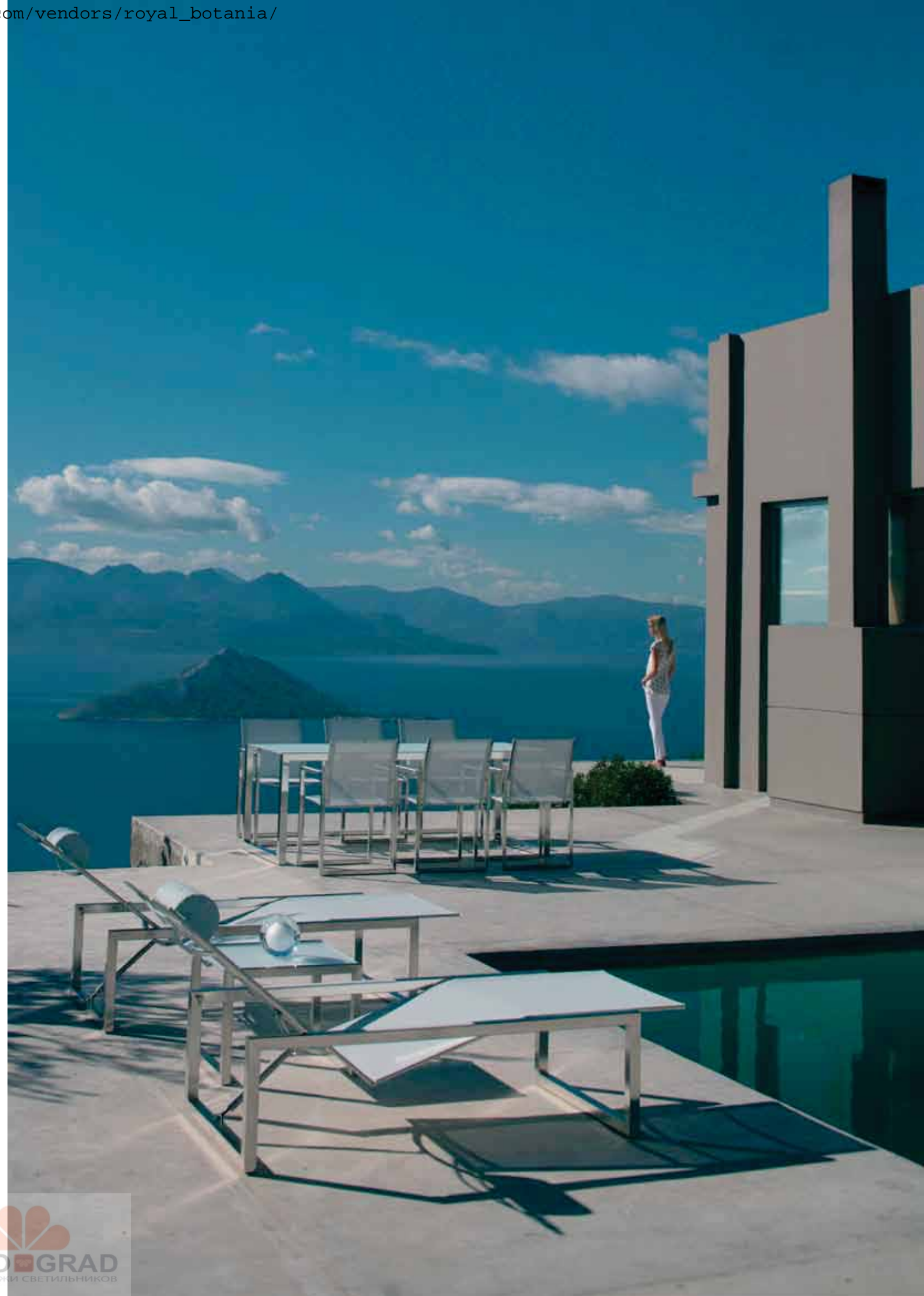







*To those who have experienced
the passion for beauty,
The ordinary will no longer
appeal...*

(Willem Elsschot 1882-1960)











NINIX



E - Z

QUITE DIFFICULT to make a hammock more compact. Very hard to make one more comfortable. Impossible one more elegant. But don't worry... just take it E-Z. ASSEZ DIFFICILE de rendre le hamac plus compact. Très dur de le rendre plus confortable. Impossible de l'imaginer plus élégant. Mais ne vous inquiétez... just take it E-Z. NICHT EINFACH eine Hängematte kompakter zu machen. Sehr schwer sie komfortabler zu machen. Unmöglich sie eleganter zu machen. Aber keine Sorge.. just take it E-Z. NIET EENVOUDIG een hangmat compacter te maken. Zeer moeilijk haar comfortabeler te maken. Onmogelijk eleganter. Maar geen zorgen... just take it E-Z. ABBASTANZA DIFFICILE produrre un'amaca più compatta. Molto difficile produrne una più comoda. Impossibile produrne una più elegante. Ma non preoccupatevi... just take it E-Z. REALMENTE DIFICIL hacer una hamaca más compacta. Complicado hacer una más confortable. Imposible una más elegante. Pero no te preocupes,.. just take it E-Z.

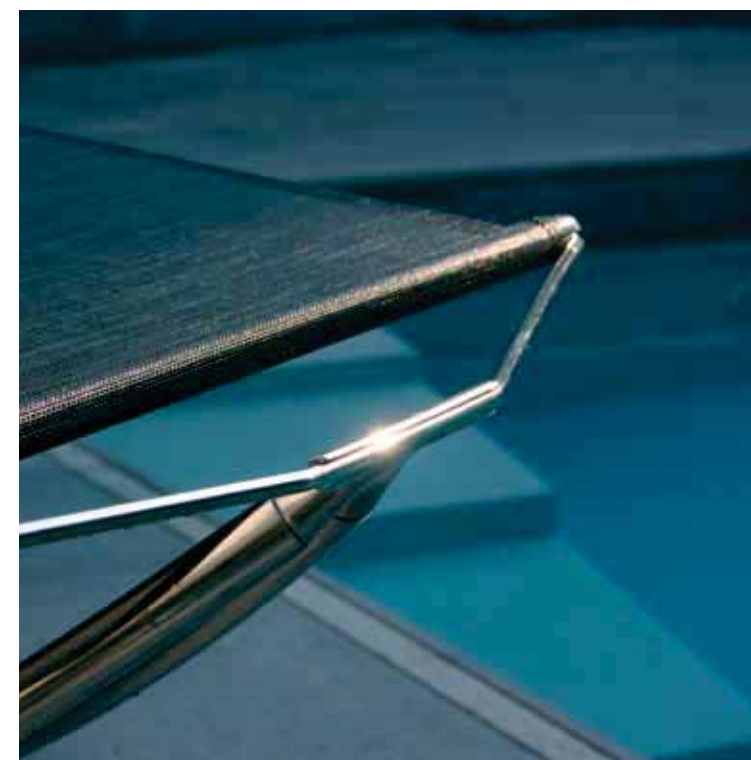



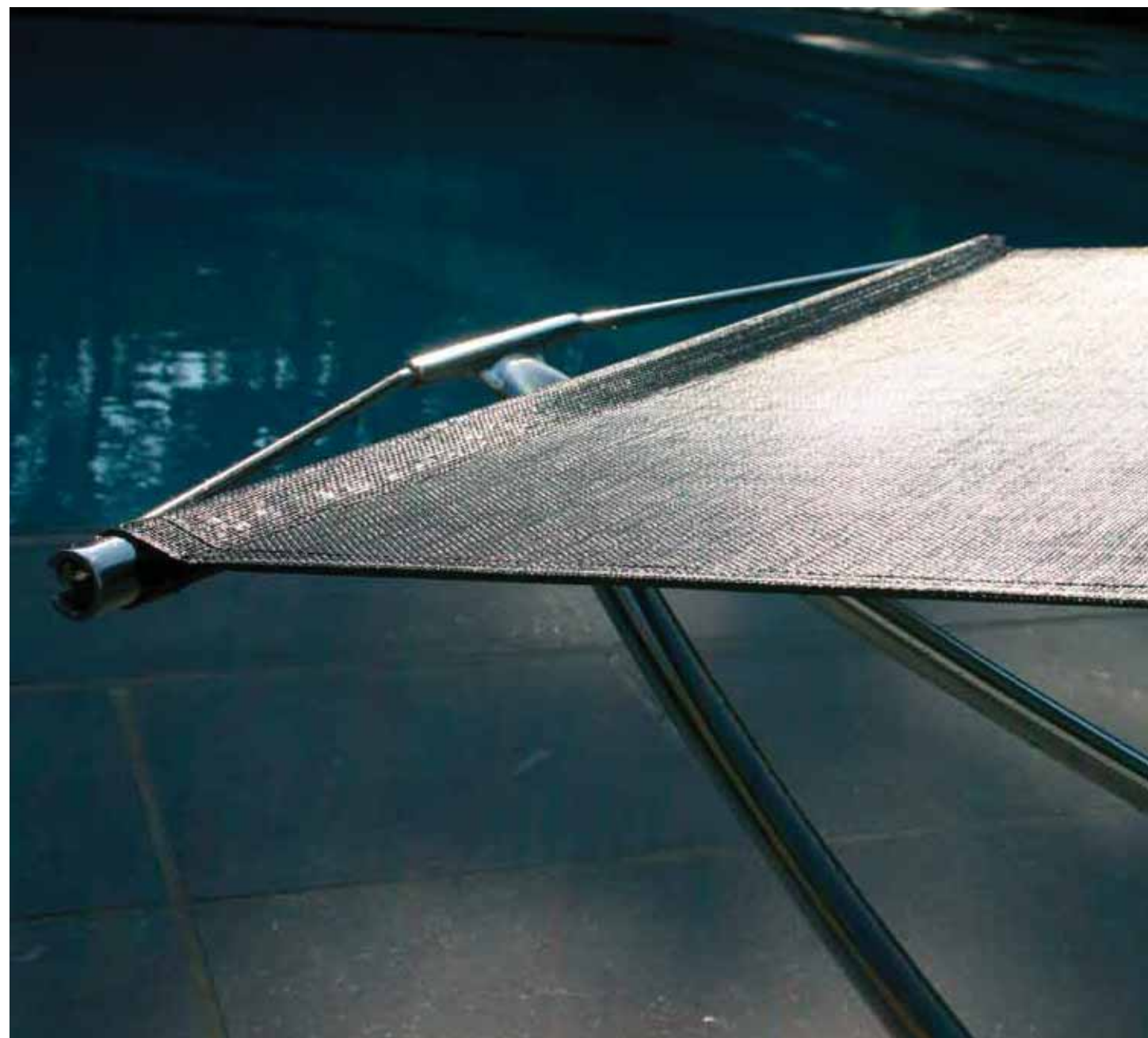

Just take it EZ...

WE STILL CHERISH OUR ROOTS! Indeed for many years the Royal Botania name has been associated with fine teak outdoor furniture. That is why the refinement that Royal Botania is known for is obviously found in the selection of carefully harvested mature teakwood, the supreme precision of the manufacturing and of course the ergonomic designs. Indeed...only the best is good enough! DURANT CES ANNÉES la diversité de Royal Botania n'a jamais cessé de grandir sans pour autant nous éloigner de nos racines. De ce fait depuis toutes ces années notre nom a toujours été synonyme de haute qualité en mobilier en teck. L'excellence de Royal Botania est apportée dans le choix du bois de teak mûr soigneusement récolté, la précision suprême de la fabrication, et naturellement des conceptions ergonomiques. En effet... seulement le meilleur est assez bon ! WIR WERDEN AN UNSEREN WURZELN FESTHALTEN! Schon allein deswegen, weil unser Name in Verbindung gebracht wird mit hoch qualitativen Teakholz Möbeln. Seit vielen Jahren wird der Name Royal Botania mit qualitativ hochwertigen Teakholz-Möbeln in Verbindung gebracht. Die hohe Qualität, für die Royal Botania bekannt ist, ist in der Auswahl von sorgfältig gerodetem, ausgereiftem Teakholz, in der Präzision bei der Herstellung und in dem ergonomischem Design begründet. Es ist wahr ... nur das Beste ist gut genug. WIJ BLIJVEN TROUW AAN ONZE ROOTS! Sinds vele jaren immers wordt onze naam geassocieerd met superieure teakhouten buitenmeubelen. Om die reden wordt de verfijning waarvoor Royal Botania vermaard is, teruggevonden in de selectie van het zorgvuldig geogste teakhout, in de precisie van de verwerking ervan, en in het uitzonderlijk comfort van het eindproduct. Immers...enkel het beste is goed genoeg! NON DIMENTICHIAMO LE NOSTRE ORIGINI! Infatti da molti anni il nostro nome viene associato ai mobili da esterno in ottimo teak. La qualità che viene riconosciuta a Royal Botania è da ricercare nell'accurata selezione del legno di teak maturo, nell'estrema precisione della produzione e logicamente nel design ergonomico. Infatti ... solo il meglio è abbastanza buono! AUNQUE LA DIVERSIDAD de la línea de Royal Botania ha crecido durante años, seguimos teniendo nuestra identidad. De hecho, hace muchos años que nuestro nombre ha venido siendo asociado con teca de alta calidad para exterior. Es por ello que la delicadeza por la que es conocida Royal Botania es obviamente encontrada en la selección de la teca madura cultivada cuidadosamente, en la suprema precisión en la fabricación, y por supuesto, en los diseños ergonómicos. De hecho...sólo lo mejor es suficientemente bueno!

SOLID



Design: Kris Van Puyvelde

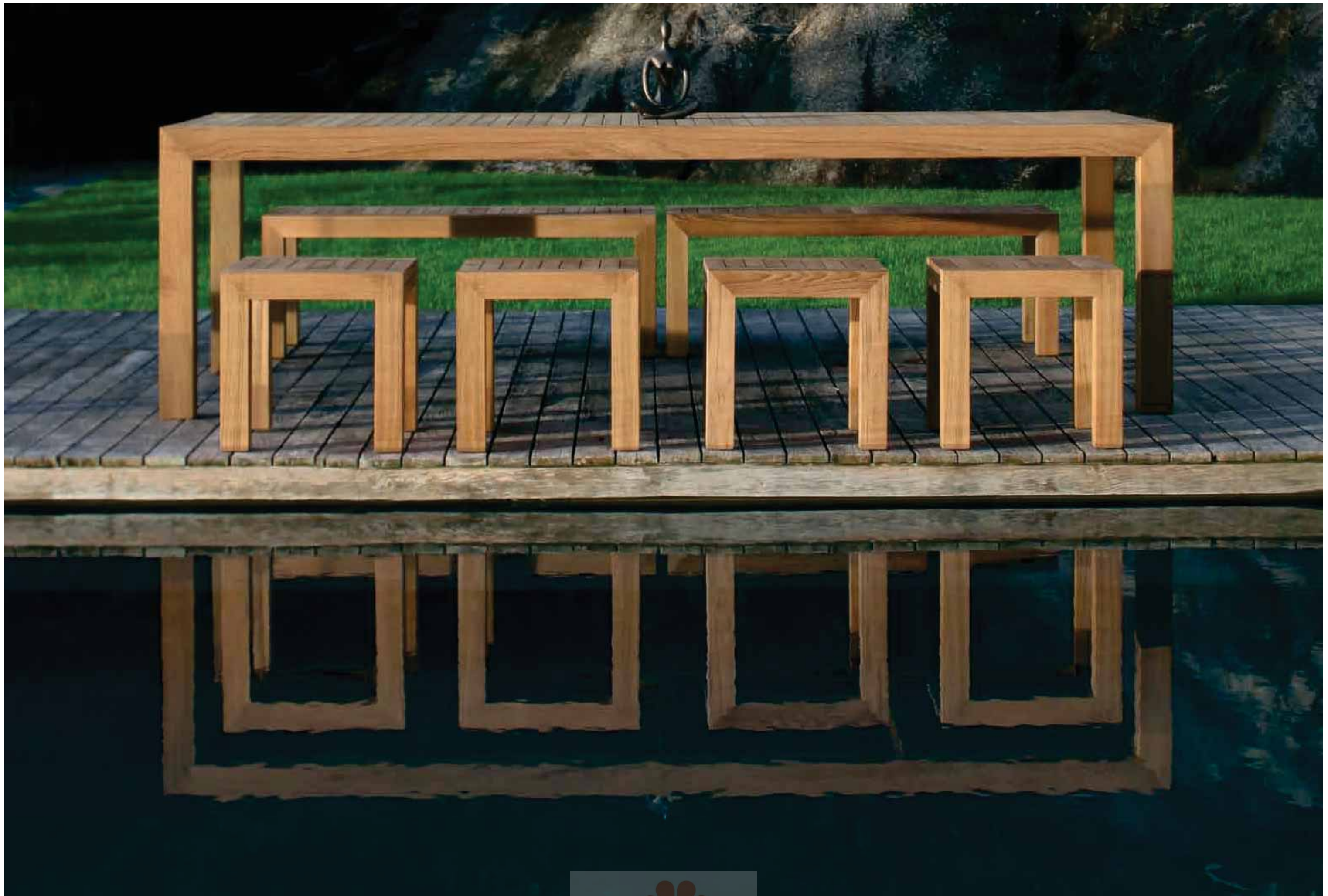

SOLID





SOLID



SOLID



Saint-Tropez France 11.55 am 28°c

SOLID





SOLID



SOLID



GETTING AWAY from the hectic world, sheltering in your own private universe, that's what KOKOON is all about. Suspended between earth and sky, either all by yourself or with some friends. A set of curtains can be added, making your KOKOON an even more romantic place to dwell. SE TENIR LOIN de l'agitation de notre monde, s'abriter confortablement dans notre univers privé, voilà la raison d'être de KOKOON. Seul ou entre amis, vous y serez suspendu entre ciel et terre. L'ajout de voiles en fera un endroit encore plus romantique où vous étendre. ABSTAND NEHMEN von der hektischen Aussenwelt, sich zurückziehen in ein eigenes kleines Universum, das ist KOKOON. Schwebend zwischen Erde und Himmel, entweder ganz allein oder gemeinsam mit Freunden. Einen noch romantischeren Ort zum Verweilen machen Ihrem KOKOON die zusätzlichen Gardinen. SCHUILEN, VER WEG van het hectische leven, in uw eigen private wereld, dat is waar KOKOON voor staat. Als het ware zwevend tussen hemel en aarde, rustig luieren, zij het alleen of in gezelschap. De optionele gordijnset, maakt de KOKOON bovendien tot een nog romantischer plekje om te vertoeven. FUGGIRE DAL MONDO caotico per rifugiarsi nel proprio universo privato? Ecco KOKOON! Sospesi tra terra e cielo, da soli oppure con gli amici. Per una maggiore riservatezza può essere aggiunto un set di tende; ciò renderà la Vostra KOKOON un ambiente ancora più romantico in cui riposare. HUIR DEL AGITADO MUNDO, refugiarte en tu propio universo, eso es KOKOON. Suspendido entre la tierra y el cielo, con tu propia compañía o con la de amigos. Para aquellos que se preocupan de más privacidad, se puede añadir un set de cortinas, haciendo de su KOKOON un lugar aun más romántico donde vivir.

KOKOON

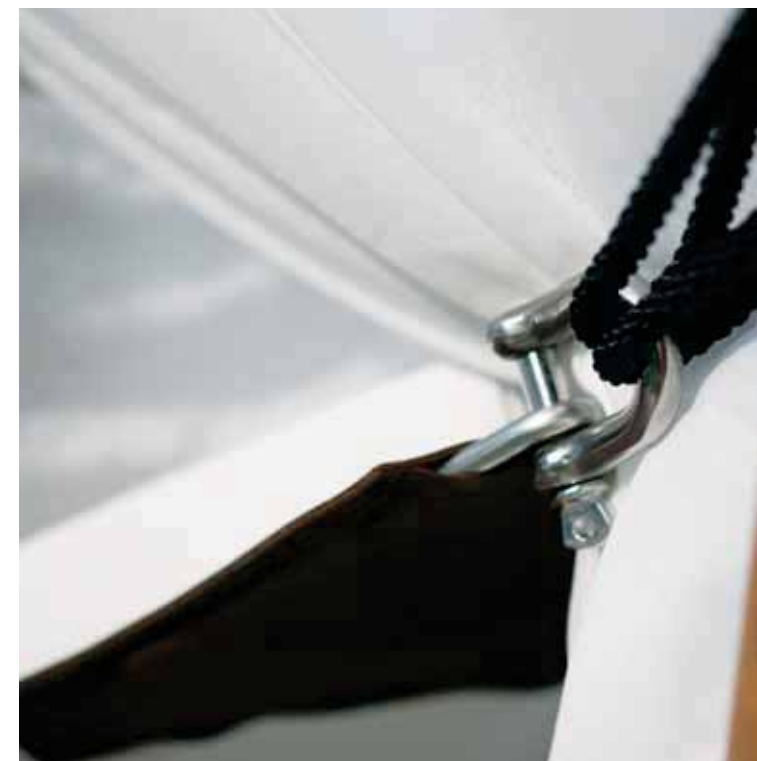

Design : Olivier Le Pensec



K O K O O N



Your private universe...

ARE YOU CAPTIVATED by the warm elegance of woven fibre? If so, the SUNDAY collection might be your ideal choice. The aluminium frame has been shaped by the principles of ergonomics and aesthetics, mixing straight lines and smooth curves. Only an expert can weave the CoaXXS® fibre in the way it is woven on a "SUNDAY". The result speaks for itself... ETES VOUS ATTIRÉ par l'atmosphère chaude d'une fibre tissée ? Si non, la collection SUNDAY pourrait être votre choix. Notre structure aluminium est régie par les lois de l'ergonomie et de l'esthétisme, associé à des lignes droites et courbes douces. Seul un expert peut tisser la fibre CoaXXS®, comme cela est tissé sur un meuble SUNDAY. Le résultat parle de lui même. SPRICHT SIE DIE ELEGANZ eine gewobenen Faser an? Dann ist die Linie SUNDAY die richtige Wahl. Der aus Aluminium geformte Rahmen entspricht ergonomischen und ästhetischen Erfordernissen. Gerade Linien und weiche Kurven werden kombiniert. Die CoaXXS Faser ist nur in professionellen Verfahren herstellbar. Das Ergebnis spricht für sich... KAN DE WARME UITSTRALING van een geweven vezel u bekoren, dan is de SUNDAY mogelijk uw keuze. Het aluminium frame werd opgebouwd uit zachte rondingen en rechte lijnen om zowel de esthetiek als de ergonomie te dienen. Vervolgens werd de CoaXXS® vezel er op meesterlijke wijze rond geweven. Het resultaat spreekt voor zich.... SIETE AFFASCINATI dalla calda atmosfera che una fibra intrecciata sa creare? Se si, la collezione SUNDAY potrebbe essere la soluzione che cercate. La struttura in alluminio è stata plasmata dalle regole dell'ergonomia e dell'estetica mischiando linee diritte a morbide curve. Solo un esperto può intrecciare la fibra CoaXXS® nello stesso modo in cui è intrecciata sulla SUNDAY. Il risultato parla da solo. TE VES ATRAIDO por la cálida atmósfera de un tejido de fibra? Si es así la colección SUNDAY será tu alternativa. La estructura de aluminio ha sido construida siguiendo las reglas de ergonomia y estética, mezclando lineas rectas y curvas suaves. Sólo un experto puede tejer la fibra CoaXXS® de esta manera. El resultado habla por si solo...

SUNDAY



Design: Kris Van Puyvelde - Frank Boschman



SUNDAY

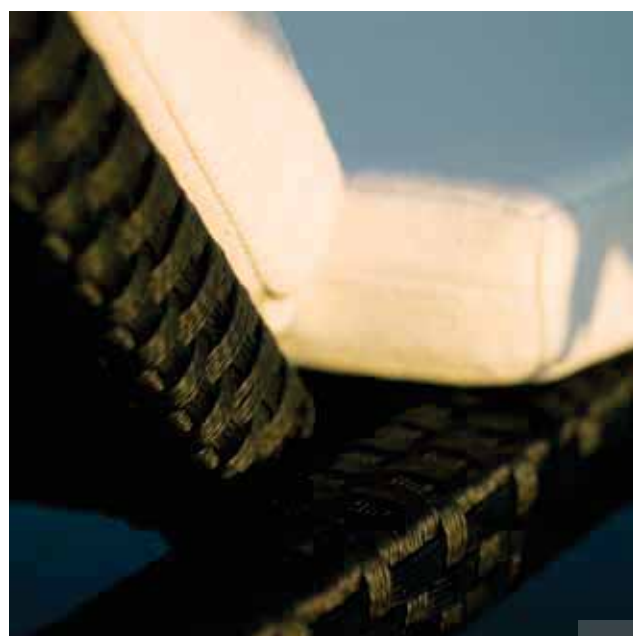
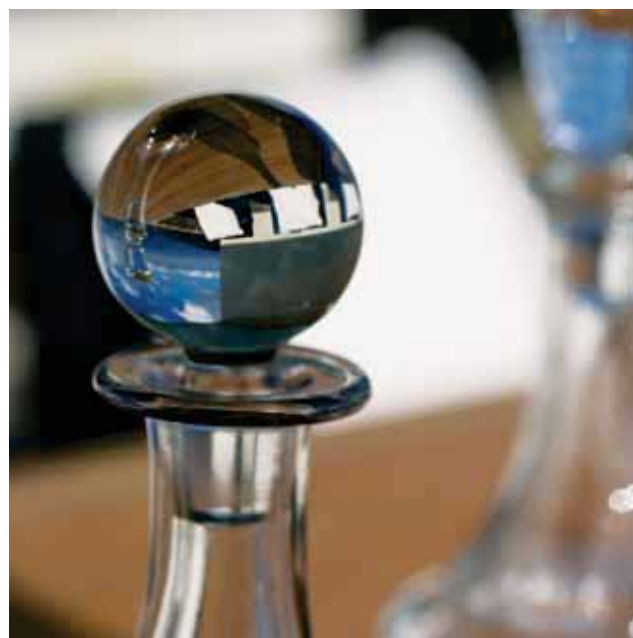

SUNDAY



Kea Greece 2.05 pm 27c



SUNDAY

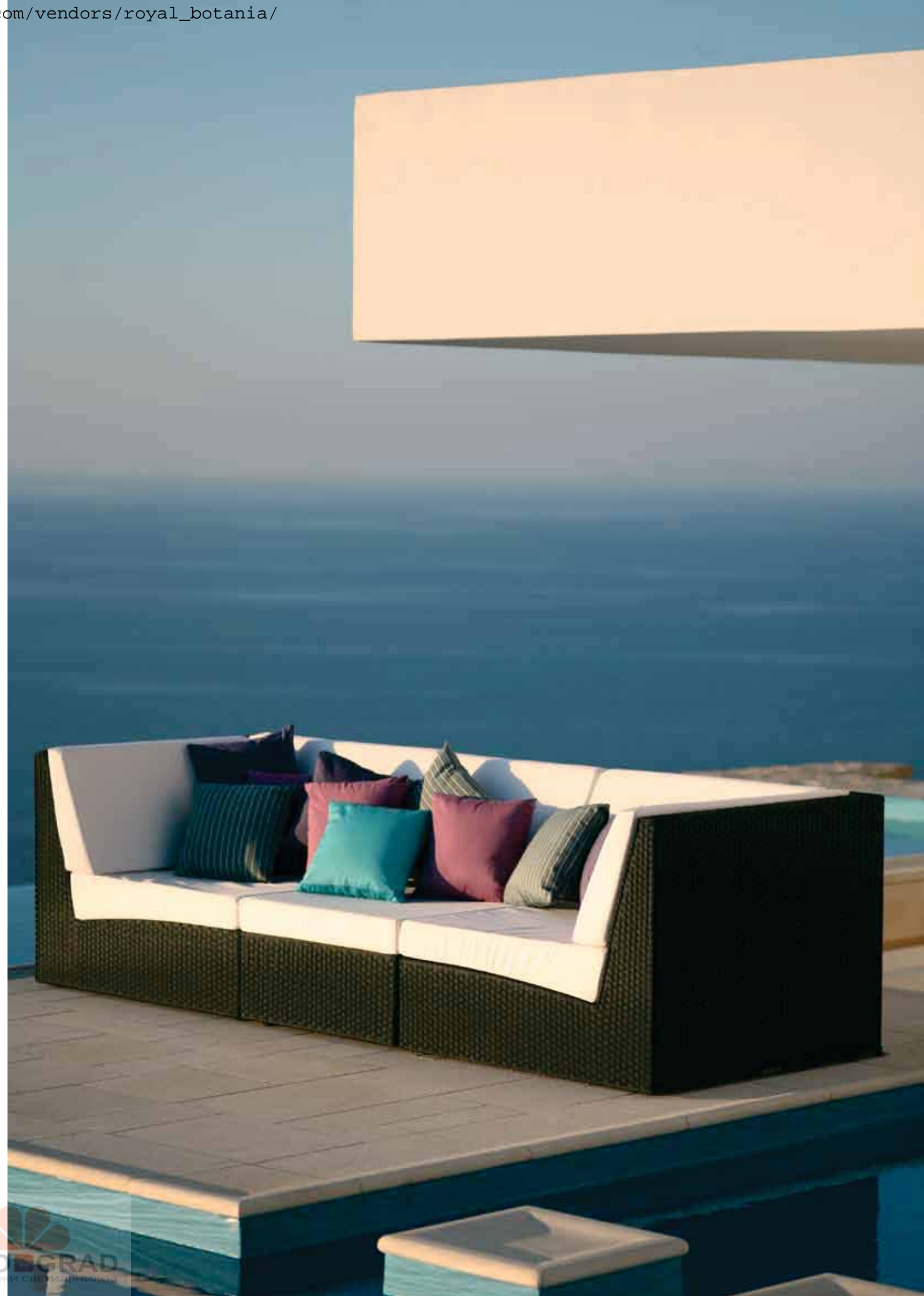

SUNDAY

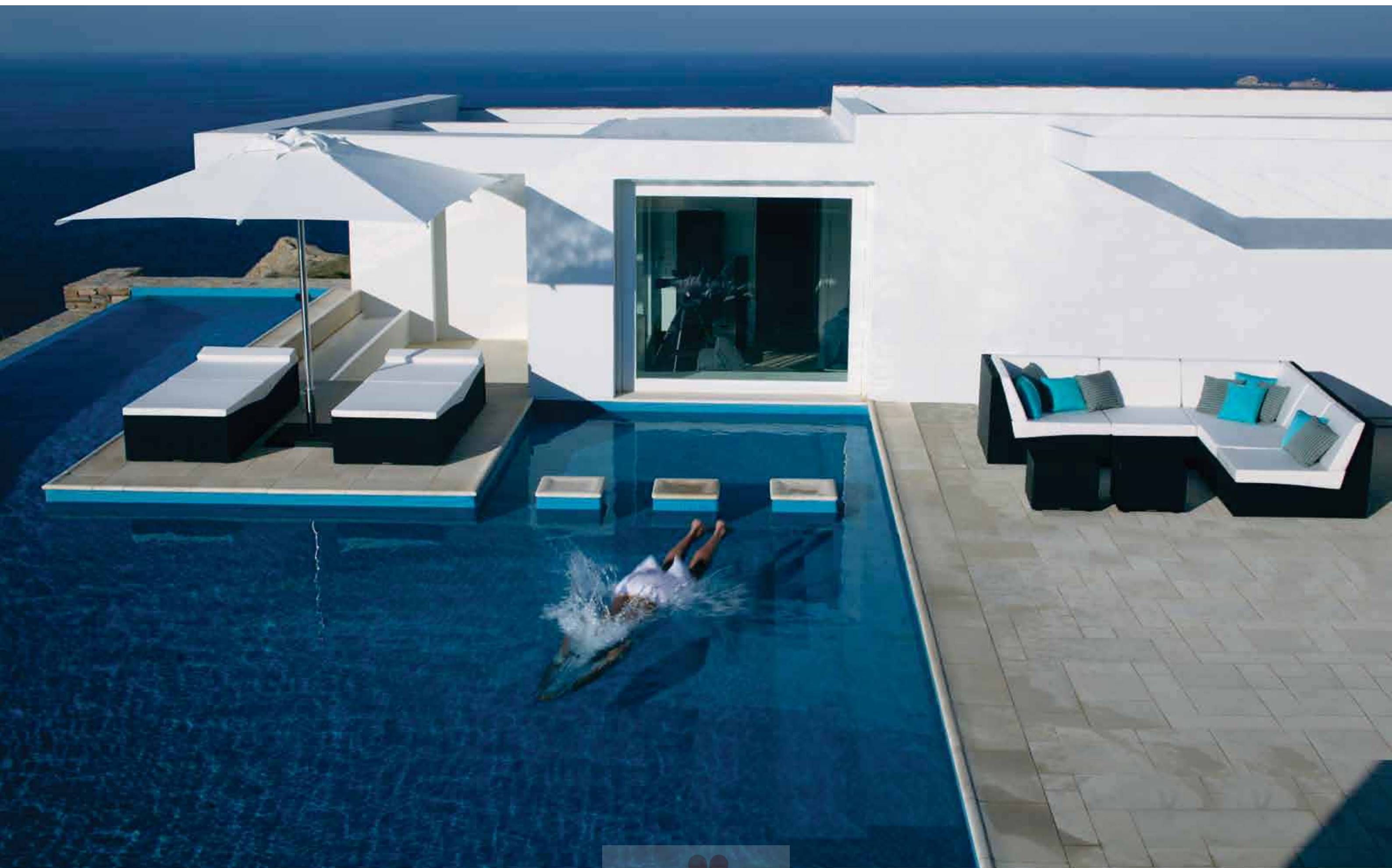





St Tropez France 9.17 pm 26c

SUNDAY



Sicily

Italy

2.25 pm 25°C



MIXT

MIXT: THE NAME REVEALS THE CONCEPT- a mix of different materials. The frame is made of noble mature teak, the subframe of stainless steel, and finished with a Batyline® upholstery. This series blends perfectly into its environment, be it contemporary or more classical. MIXT: LE NOM REFLÈTE LA COMBINAISON de différents matériaux. La structure est réalisée à partir d'un teck noble. Le cadre de fixation est composée d'acier inoxydable, garnie par une toile Batyline®. Cette collection se fond parfaitement dans son environnement, contemporain ou plus classique. MIXT: DER NAME VERRÄT DAS KONZEPT – ein Mix aus verschiedenen Materialien. Die Rahmen dieser Linie sind aus veredeltem, gereiftem Teakholz gefertigt. Die für Komfort sorgende Bespannung aus elastischem, wetterfestem Batyline Gewebe ist mittels Eckstahlstreben an den Rahmen befestigt. Ein Highlight dieser Serie liegt in der Anpassungsfähigkeit an eine individuelle Umgebung – zeitgemäß oder klassisch. MIXT: DE NAAM VERRAADT HET CONCEPT. Inderdaad in deze reeks wordt een "mix" gebracht van materialen. Het frame is vervaardigd uit nobel volwassen teakhout en roestvrij staal met daarop een bespanning uit Batyline® polyesterweefsel. De MIXT reeks voelt zich perfect thuis zowel in een meer eigentijds als in een eerder klassiek kader. MIXT: IL NOME RIVELA IL CONCETTO di abbinamento di materiali. La struttura è costruita con splendido teak maturo, il tessuto Batyline® è fissato alla struttura mediante un sottotelaio di acciaio inossidabile. Un vantaggio di questa serie è come si armonizzi perfettamente nel suo ambiente, che sia esso contemporaneo o più classico. MIXT: EL NOMBRE REVELA EL CONCEPTO- un mix de diferentes materiales. La estructura está construida en madera de teca noble, la subestructura en acero inoxidable, y tejido en tela Batyline®. La ventaja de esta serie es cómo se adapta perfectamente a su ambiente, ya sea éste contemporáneo o más clásico.



Design : Kris Van Puyvelde





THE ORIGIN OF THE NEW ENGLAND RANGE is based on the Adirondack chair, first designed by Thomas Lee in 1903 for his summerhouse in Westport New York. When updating this American classic, our focus was on getting it more aesthetically balanced, enhancing the functionality and level of refinement, without disavowing its roots. L'ORIGINE DE LA SERIE NEW ENGLAND est basée sur la chaise Adirondack, initialement conçue par Thomas Lee en 1903 pour sa maison d'été à Westport New York. En mettant à jour ce classique américain, notre objectif était d'obtenir un résultat plus esthétiquement équilibré, augmentant la fonctionnalité et le niveau de finition, sans désavouer ses racines. DAS VORBILD DER LINIE NEW ENGLAND ist der Adirondack Stuhl, der 1903 von Thomas Lee für sein Sommerhaus in Westport New York entworfen wurde. Als Royal Botania diesen amerikanischen Klassiker für sich wiederentdeckte, wurde besonderer Wert auf die ästhetische Weiterentwicklung, Funktionalität und die Verarbeitung gelegt, ohne die ursprüngliche Idee dabei zu verfälschen. DE NEW ENGLAND REEKS vindt haar oorsprong in de Adirondack stoel ontworpen in 1903 door Thomas Lee voor zijn zomerverblijf in Westport New York. Bij het actualiseren van deze Amerikaanse klassieker legden we de nadruk op het bekomen van een zuiverdere esthetische balans en het verhogen van zowel de functionaliteit als de afwerkingsgraad. L'ORIGINE DELLA COLLEZIONE NEW ENGLAND trae spunto dalla sedia Adirondak, progettata nel 1903 da Thomas Lee per la sua casa estiva a Westport, New York. Abbiamo riaggiornato questo classico americano concentrandoci sull'idea di renderlo esteticamente bilanciato, aumentandone la funzionalità ed il livello di finitura, senza rinnegarne le origini. EL ORIGEN DE LA COLECCIÓN NEW ENGLAND se encuentra en la silla "Adirondack", primeramente diseñada por Thomas Lee para su casa de campo en Westport New York. Al adaptar este clásico americano, nuestro objetivo ha sido hacerlo más estético, resaltando la funcionalidad y delicadeza, pero sin sacarlo de sus originarias raíces.

NEW ENGLAND



Design : Pierre Stelmaszyk

NEW ENGLAND





*Details make quality,
but quality is not a detail!*

(Leonardo da Vinci 1452-1519)

AN EYE STRIKING SET WITH CHARISMA TO SPARE. The rough Teak or Mahogany beams are joint to the aluminium frame by obvious dovetail shaped strips, found also in the matching bench and stools. A very old technical solution, that proves today to work esthetically as well !The picnic-set taken to an unseen level!

UN OEIL FRAPPANT SERTI DE CHARISME À REVENDRE. Les poutres en teck ou en acajou forment le plateau et sont rattachées au cadre en aluminium de la table par un assemblage que l'on retrouve sur le banc et les tabourets de la collection. Une solution technique qui donne une allure séduisante à cet ensemble. Le pique-nique proposé prend tout de suite une autre dimension !

EIN BEMERKENSWERTES SET MIT CHARISMA. Die groben Teak- oder Mahagoniebalken sind durch passend geformte Kontaktleisten mit einem Aluminiumrahmen verbunden, die ebenso in der dazugehörigen Bank und den Stühlen verwendet werden. Diese sehr alte technische Lösung beweist sich noch heute als besonders ästhetisch. Das Picknick-Set ist somit auf ein unerreichbares Level angehoben. EEN ECHTE BLIKVANGER, MET CHARISMA TE OVER! De ruwe balken uit teakhout of mahonie, worden stevig verankerd op het aluminium frame middels zware zwaluwstaart-verbindingen. Deze eeuwenoude technische oplossing, die heden tevens haar esthetisch nut bewijst, wordt herhaald bij zowel de krukken als de bank. De picknickset getilt naar ongeziene hoogte!

UN SET CHE SALTA ALL'OCCHIO CON TUTTO IL SUO CARISMA. Il tavolo è costituito da travi grezze in teak o in mogano unite a un telaio di alluminio mediante spine a coda di rondine, modo di giunzione impiegato anche per le panche e gli sgabelli coordinati. Una soluzione tecnica molto antica, di cui riscopriamo oggi anche la valenza estetica! Con Vigor il set da picnic viene portato a un livello mai visto!

UN CONJUNTO MUY LLAMATIVO CON CARISMA DE SOBRA. La madera de teca o de caoba se encaja con la estructura de aluminio con las mismas bandas que se encuentran en el banco y los taburetes a juego. ¡Una antigua solución estética muy técnica que demuestra que hoy también funciona! ¡Todo lo que necesitas para el picnic llevado a niveles nunca vistos!

VIGOR



Design: Frank Boschman

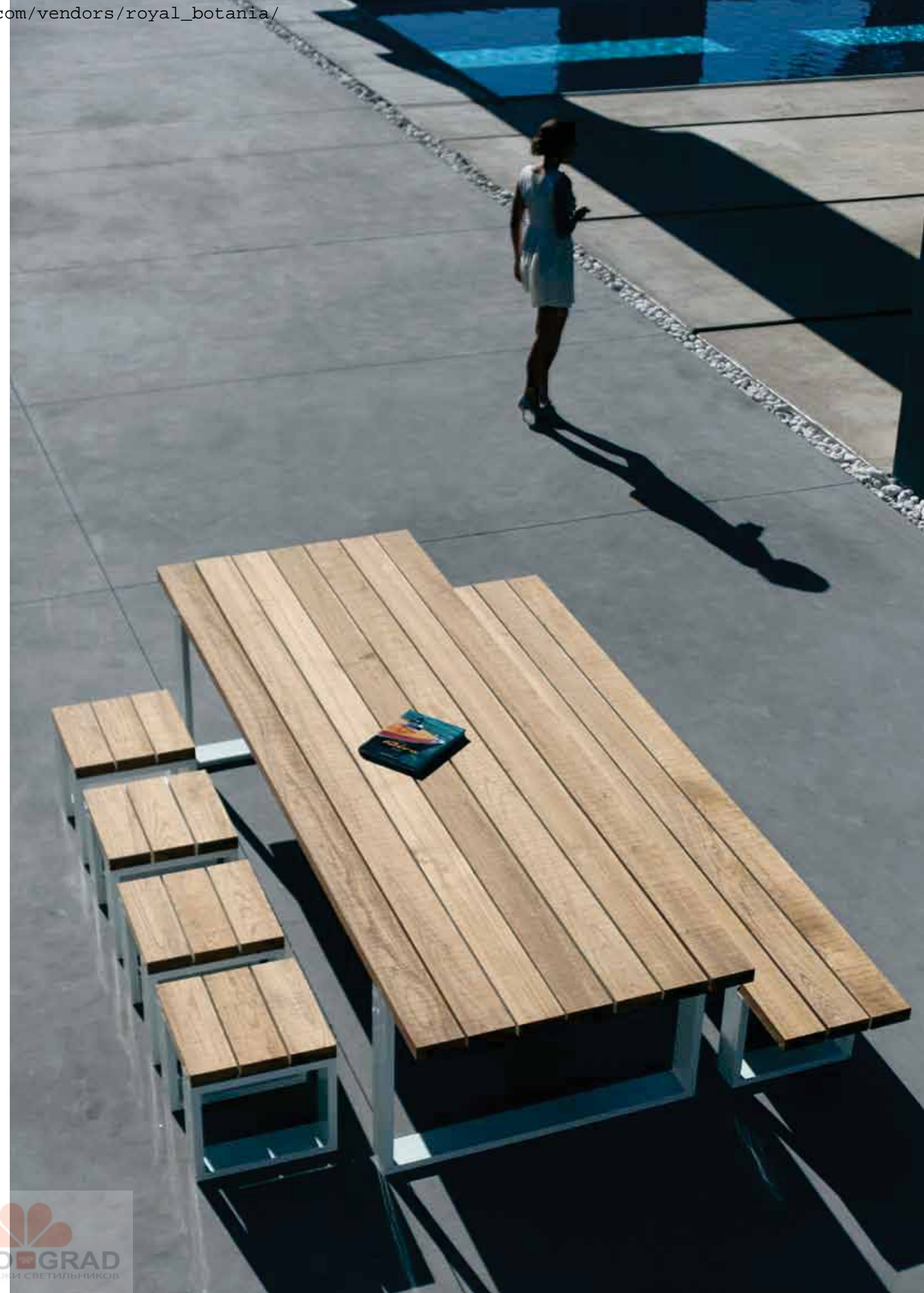

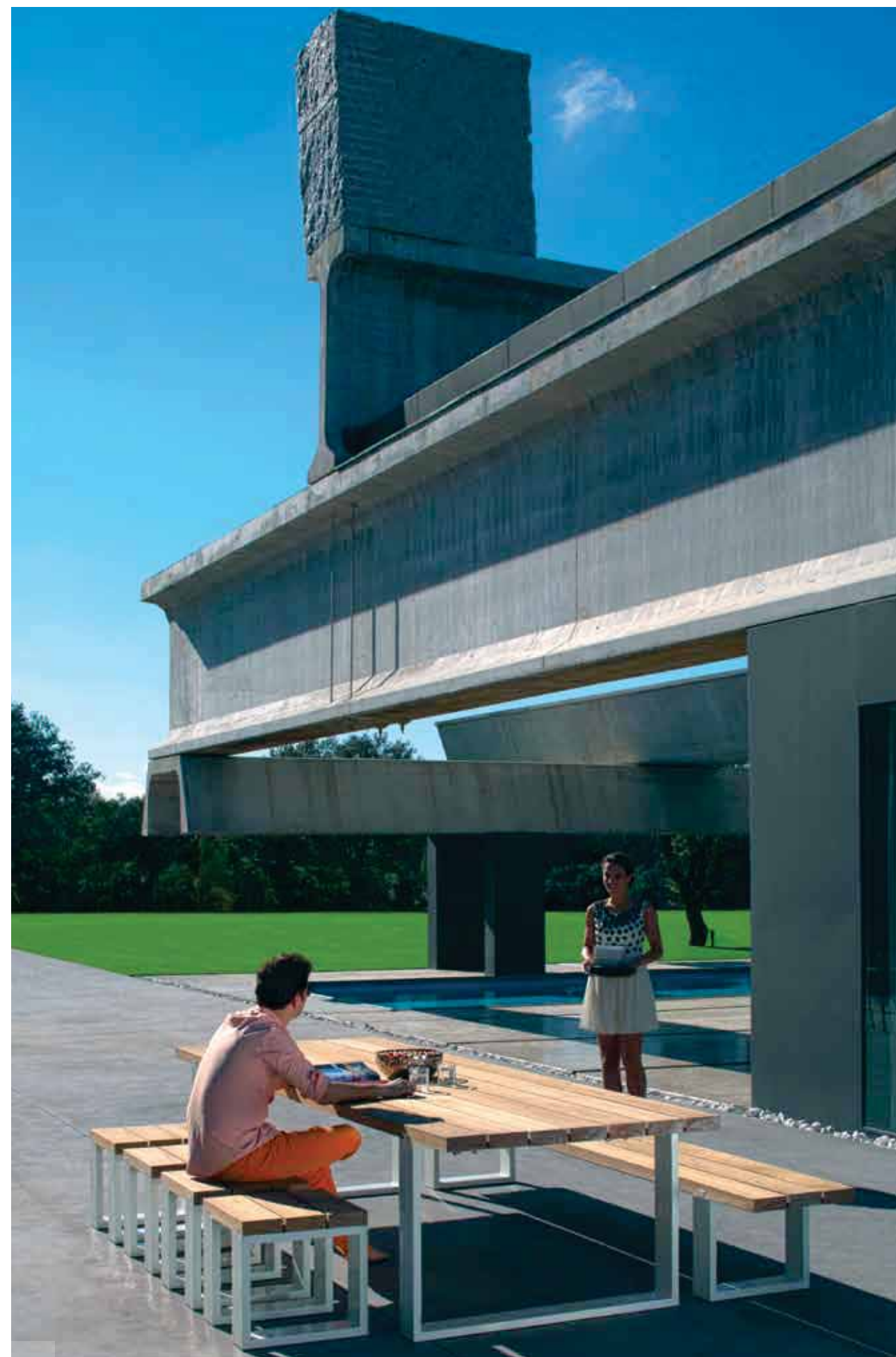

RED LABEL

YOU COULD REGARD THE PRODUCTS UNDER THE RED LABEL umbrella, as our "light" collection. Light in this case does not necessarily refer to their weight, even though when developing the range the focus was on an economical use of material without compromising the overall quality and refinement, a feature that has given the Royal Botania brand its worldwide appreciation. LES PRODUITS SOUS LE DÉNOMINATEUR « RED LABEL » pourraient être considérés comme notre collection « light ». Ceci ne vise pas nécessairement le poids des produits, bien que pour leur développement, l'accent a été mis sur une utilisation économique des matériaux. Ce qui ne veut cependant absolument pas dire que des compromis ont été faits en ce qui concerne la qualité et la finition pour lesquelles Royal Botania est célèbre dans le monde entier. MAN KÖNNTE DIE PRODUKTE UNTER DEM "RED LABEL"-Nenner als unsere "Light"-Kollektion betrachten. Das bezieht sich nicht unbedingt auf das Gewicht der Produkte, obwohl bei der Entwicklung der Fokus deutlich auf die ökonomische Materialverwendung gerichtet war. Das heißt jedoch nicht, dass hier Kompromisse betreffend der bekannten Qualität und Verarbeitung, für die Royal Botania bekannt ist, geschlossen wurden. U ZOU DE PRODUCTEN ONDER DE "RED LABEL" noemer kunnen beschouwen als onze "light" collectie. Dit duidt in deze niet noodzakelijkerwijs op het gewicht van de producten, hoewel bij de ontwikkeling de focus wel degelijk was op economisch gebruik van materialen. Dit wil echter hoegenaamd niet zeggen dat hier compromissen werden gesloten wat betreft de wereldvermaarde kwaliteit en afwerking, waar de Royal Botania naam voor staat. I PRODOTTI CHE RIENTRANO NELLA CATEGORIA "RED LABEL" possono essere considerati la nostra collezione "light". E con questa definizione non necessariamente si fa riferimento al peso dei prodotti, quanto piuttosto al fatto che in fase di progettazione si è cercato di porre l'attenzione sull'utilizzo economico dei materiali. Tuttavia, nella pratica, ciò non significa essere scesi a compromessi su quella qualità, rinomata in tutto il mondo, che il nome di Royal Botania rappresenta. PODRÍA CONSIDERAR LOS PRODUCTOS BAJO LA SOMBRILLA RED LABEL como nuestra colección más "light". "Light" en este caso poco tiene que ver con su peso, a pesar de que cuando se desarrolló la línea, la atención se centró en un uso económico del material, sin comprometer con ello la calidad y el refinamiento general que ha otorgado a la marca Royal Botania su reconocimiento mundial.



THOSE WHO THOUGHT THAT IT HAD BECOME QUITE IMPOSSIBLE to bring out really innovating aluminium range, are proven wrong by the ALURA. All this without compromising comfort and functionality. The range of soft edged stackable chairs, relax chairs, and barstools - available in a textured black, white and sand finish- is complemented by a lounge with unequalled ergonomics. With a simple push you activate the hydraulic piston, hidden inside the frame, lowering the seat, lifting the backrest and knees while lower your feet. A patented piece of engineering only featured in this Royal Botania masterpiece, setting new standards in outdoor ergonomics! CEUX QUI PENSAIT QU'IL ÉTAIT IMPOSSIBLE qu'une collection innovatrice en aluminium puisse se mettre à l'extérieur se trompent. L'innovation de la collection Alura prouve le contraire. Et sans compromis entre confort et fonctionnalité. Une gamme de chaises empilables, de fauteuils et de tabourets de bar, disponibles en finition noire, blanc ou sable, complétée par une chaise longue d'une ergonomie inégalée. Une simple pression sur un bouton commande un piston hydraulique caché à l'intérieur du cadre, abaisse le siège, le dossier et le repose-pieds. Un mécanisme breveté présent uniquement dans ce chef d'œuvre réalisé par Royal Botania, qui établit de nouvelles normes en matière d'ergonomie de plein air! DENJENIGEN, DIE DACHTEN, DASS ES UNMÖGLICH SEI, eine wirklich innovative Aluminium-Serie herauszubringen, wird mit ALURA nun das Gegenteil bewiesen. Und all das ohne kompromittierendem Komfort und Funktionalität. Die Serie der stapelbaren Stühle mit abgerundeten Ecken, Relaxingstühle, und Barhocker - erhältlich in schwarzen, weißen und sandfarbenen Texturen - wird nun mit einer Liege mit ergonomischen Formen vervollständigt. Mit einem kurzen Druck aktiviert man einen hydraulischen Kolben, versteckt im innern des Rahmens, um den Sitz abzusenken, die Rückenlehne und Knie anzuheben, während die Füße abgesenkt werden. Das patentierte Werk der Ingenieurkunst ist nur in diesem Royal-Botania-Meisterwerk zu finden und setzt neue Standards in der Outdoor-Gemütlichkeit. WIE DACHT DAT HET QUASI ONMOGELIJK WAS, om nog vernieuwend te kunnen uitpakken in het bereik van aluminium buitenmeubelen, blijkt zich te vergissen; ALURA bewijst immers het tegendeel, en dit bovendien zonder offers te brengen qua comfort en functionaliteit; wel in tegendeel! De zacht geronde collectie omvat niet enkel hoge en lage stoelen, maar tevens een ligbed dat op het vlak van comfort zijn gelijke niet kent. Een eenvoudige druk op de knop zet een verborgen hydraulische piston in werking, die bij het oprichten van de rugleuning, de zit verlaagt, de knieën hoger brengt en de voeten lager. Een door Royal Botania, gepatenteerde technisch hoogstandje, dat ergonomie voor buitenmeubilair naar ongeziene hoogtes tilt! A CHI PENSAVA CHE SAREBBE STATO IMPOSSIBILE progettare una linea di prodotti in alluminio realmente innovativa... ecco in smentita la nuova collezione Alura! Tutto questo senza compromettere comfort e funzionalità. La gamma di sedie, poltrone e sgabelli impilabili, disponibili con finitura nera texturizzata, bianca o sabbia, fanno complemento a un lettino dall'ergonomia ineguagliabile: il semplice tocco di un pulsante attiverà un pistone idraulico nascosto all'interno del telaio, abbassando la seduta e sollevando lo schienale e la parte inferiore su cui poggiano le gambe. Un ingegnoso meccanismo brevettato presente solo in questo capolavoro di Royal Botania, che definisce nuovo standard in termini di ergonomia per l'outdoor! A LOS QUE PENSABAN QUE ERA IMPOSIBLE innovar en la gama de aluminio, ALURA les demuestra lo contrario. Todo ello sin renunciar a la comodidad ni a la funcionalidad. La gama de sillas apilables, sillones y taburetes de bordes suaves, - disponibles en negro, blanco y arena - se completa con una tumbona con una ergonomía sin igual. Simplemente con pulsar se activa el pistón hidráulico, oculto en el interior, baja el asiento y se levanta el respaldo y las rodillas mientras baja los pies. Una pieza de ingeniería patentada solo disponible en esta obra maestra de Royal Botania que j'establece nuevos estándares en ergonomía al aire libre!

ALURA



Design: Kris Van Puyvelde





Madrid Spain 3.20 pm 25°c

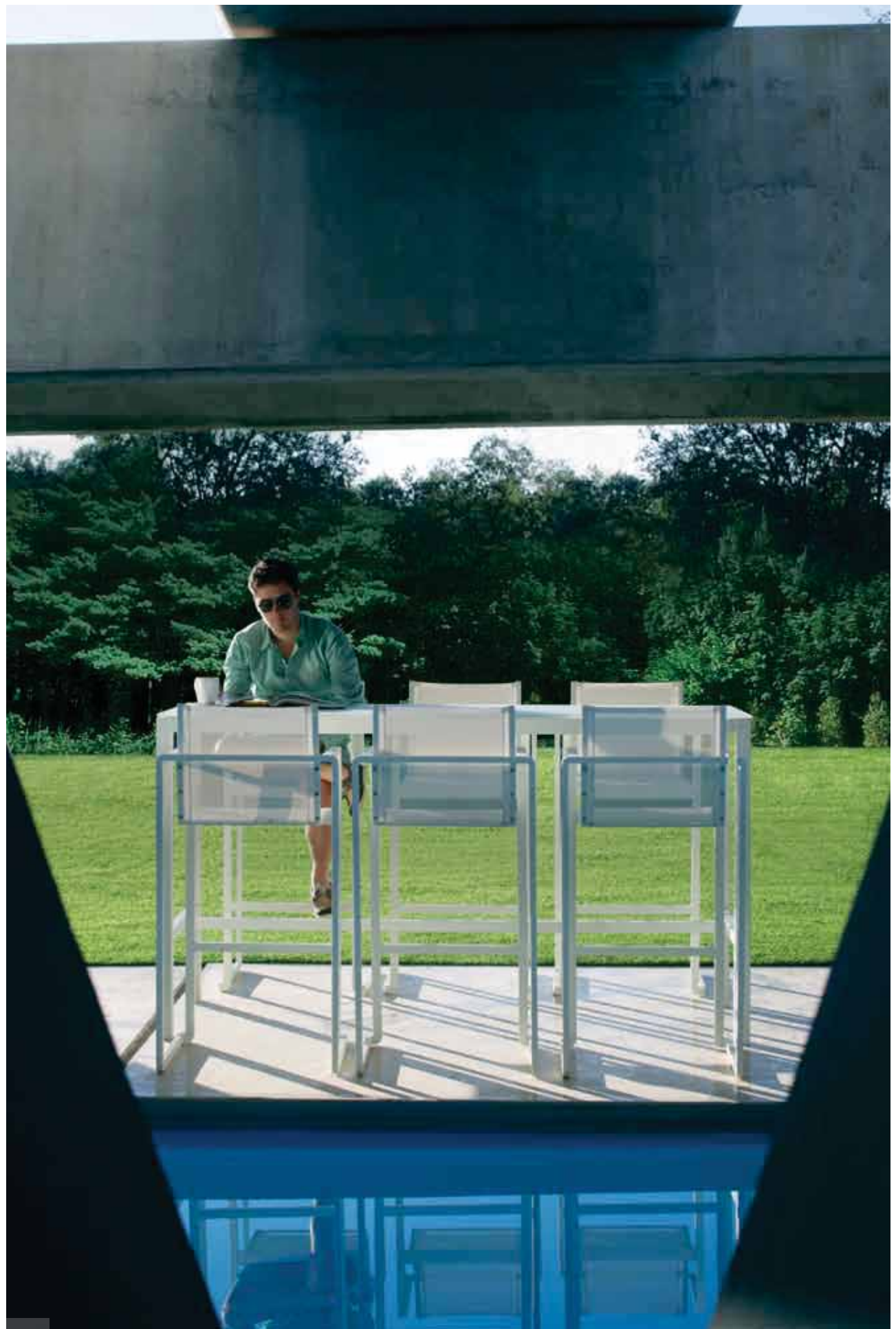







ALURA





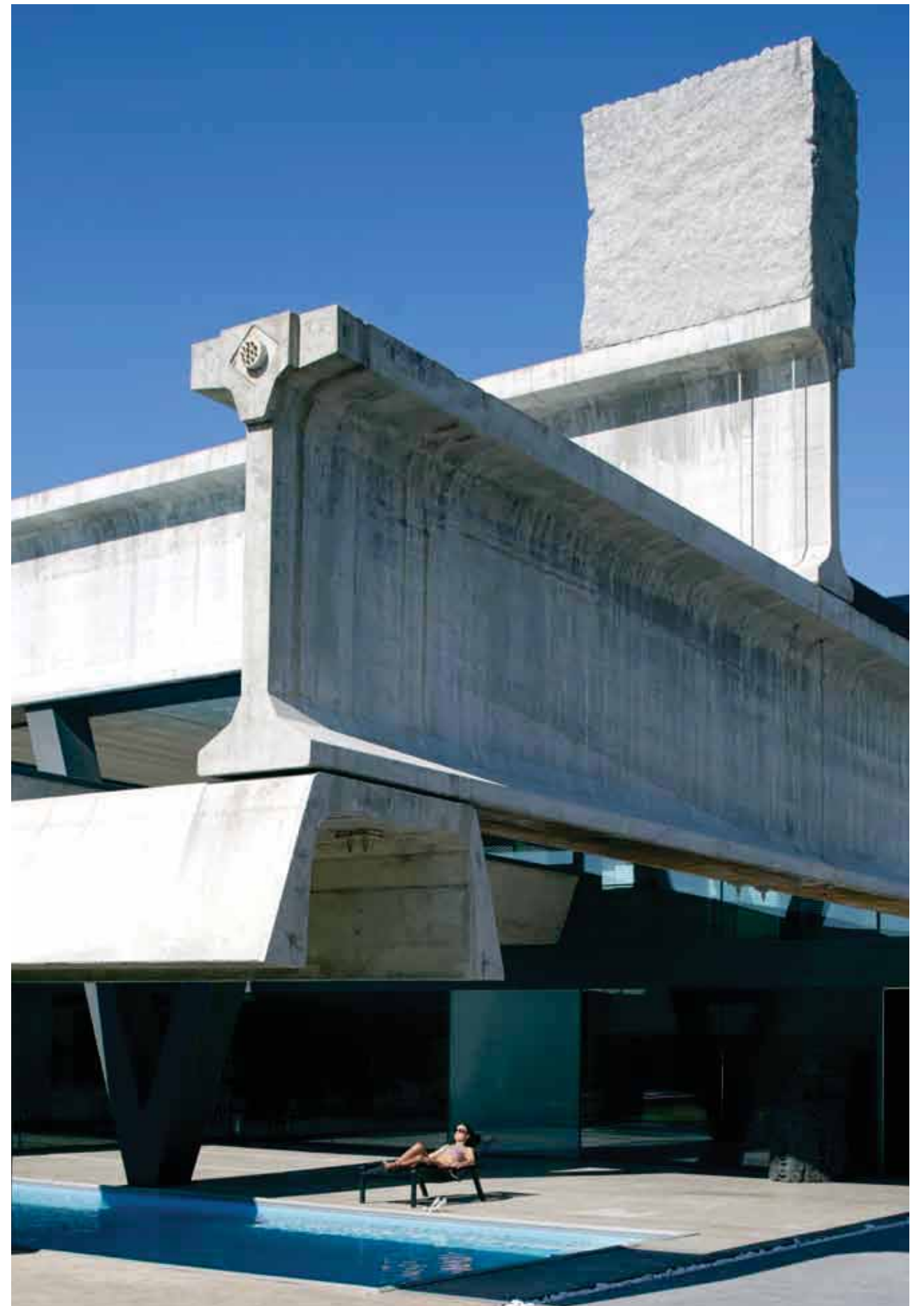

ELEGANTLY TAPERED, L-SHAPED ALUMINIUM PROFILES, pure minimalistic lines, a Batyline sling and some nice details. That's pretty much the ingredients needed to make this collection. But then the art is to combine them in the right way. We are confident you will appreciate our recipe. DES PROFILÉS D'ALUMINIUM EN L, élégamment effilés, des lignes épurées et minimalistes, une toile Batyline ,quelques jolis détails. Ce sont les ingrédients essentiels nécessaires à la réalisation de cette collection. Mais tout l'art consiste ensuite à bien les associer. Nous sommes certains que vous apprécierez notre recette. L-FÖRMIGE ALUMINIUMPROFILE, PURISTISCHE LINIEN, elegante Ecken und Kanten mit Batyline-Gewebe bespannt und feine Details, das sind schon alle Zutaten, die man benötigt, um diese Kollektion zu entwerfen. Die Kunst liegt dann in der richtige Kombination der Elemente. Wir sind uns sicher, das Sie unser Rezept wertschätzen werden. SIERLIJK TOELOPENDE ALUMINIUM L-PROFIELEN, pure minimalistische lijnen, een Batyline bespanning, en een aantal verfijnde details ; dat zijn de ingrediënten waaruit deze collectie is samengesteld. Het meesterschap bestaat erin deze in de juiste verhoudingen te combineren. Wij zijn ervan overtuigd dat ons recept u kan bekoren. LINEE ELEGANTEMENTE AFFUSOLATE, PROFILI A L IN ALLUMINIO, puro design minimalista, tessuto Batyline, e alcuni piacevoli dettagli. Sono perlopiù questi gli elementi che caratterizzano la collezione. L'arte consiste poi nel saperli combinare nel modo giusto. Siamo certi che apprezzerete la nostra ricetta. PERFIL DE ALUMINIO EN FORMA DE L que se estrecha con elegancia, de puras líneas minimalistas, con tejido de Batyline y bonitos detalles. Estos son básicamente los ingredientes necesarios para llevar a cabo esta colección. Pero el arte está en saber combinarlos bien. Estamos seguros de que disfrutará de nuestra receta.

LITTLE - L



Design: Frank Boschman

LITTLE - L



Ibiza

Spain

10.12 am 23°c



LITTLE - L



LITTLE - L



LAZY

THE PURE LOOK, the supreme all-weather upholstery and the sheer comfort offered are the obvious features of the Lazy collection. Less obvious is the unique design, allowing you to rearrange your lounge corner in no time at all, making this without doubt the most versatile lounge set on this planet! ÉVIDENTS, LE LOOK ÉPURÉ, la suprême garniture tout temps et le pur confort qui est offert. Moins évident, le design unique qui vous permet de réarranger votre coin salon en un rien de temps et qui en fait incontestablement l'ensemble de salon le plus polyvalent de la planète! DAS PURE DESIGN, die hervorragende Allwetter-Polsterung und der gebotene Komfort sind offensichtlich. Weniger augenscheinlich ist die einzigartige Konstruktion, die es erlaubt Ihre Sitzecke ohne Aufwand sofort umzugestalten. Das macht sie zweifellos zur flexibelsten Sitzkombination der Welt! EVIDENT ZIJN DE PURE "LOOK", de luxeuze regenbestendige kussens, en het hoge comfortniveau. Veel minder evident is het doordachte concept waardoor het mogelijk is deze elementen in een oogopslag om te toveren in een andere opstelling. Dit laatste maakt deze loungeset ongetwijfeld tot het meest modulaire op deze planeet! OVVI SONO LA PUREZZA DELL'ESTETICA, l'imbottitura di altissima qualità adatta a tutte le stagioni e il puro comfort offerti. Meno ovvio è il design unico, che consente di riorganizzare il vostro angolo soggiorno in poco tempo, rendendolo, al di là di ogni ragionevole dubbio, il lounge set più versatile di questo pianeta! LO MÁS EVIDENTE ES SU ASPECTO DE PUREZA, su suprema tapicería que combina con cualquier época del año y la auténtica comodidad que ofrece. Lo menos evidente es su diseño único, que le permite cambiar la decoración de su sala en un momento, convirtiéndola así, sin lugar a dudas, en la sala de estar más versátil del mundo!



Design: Kris Van Puyvelde



LAZY

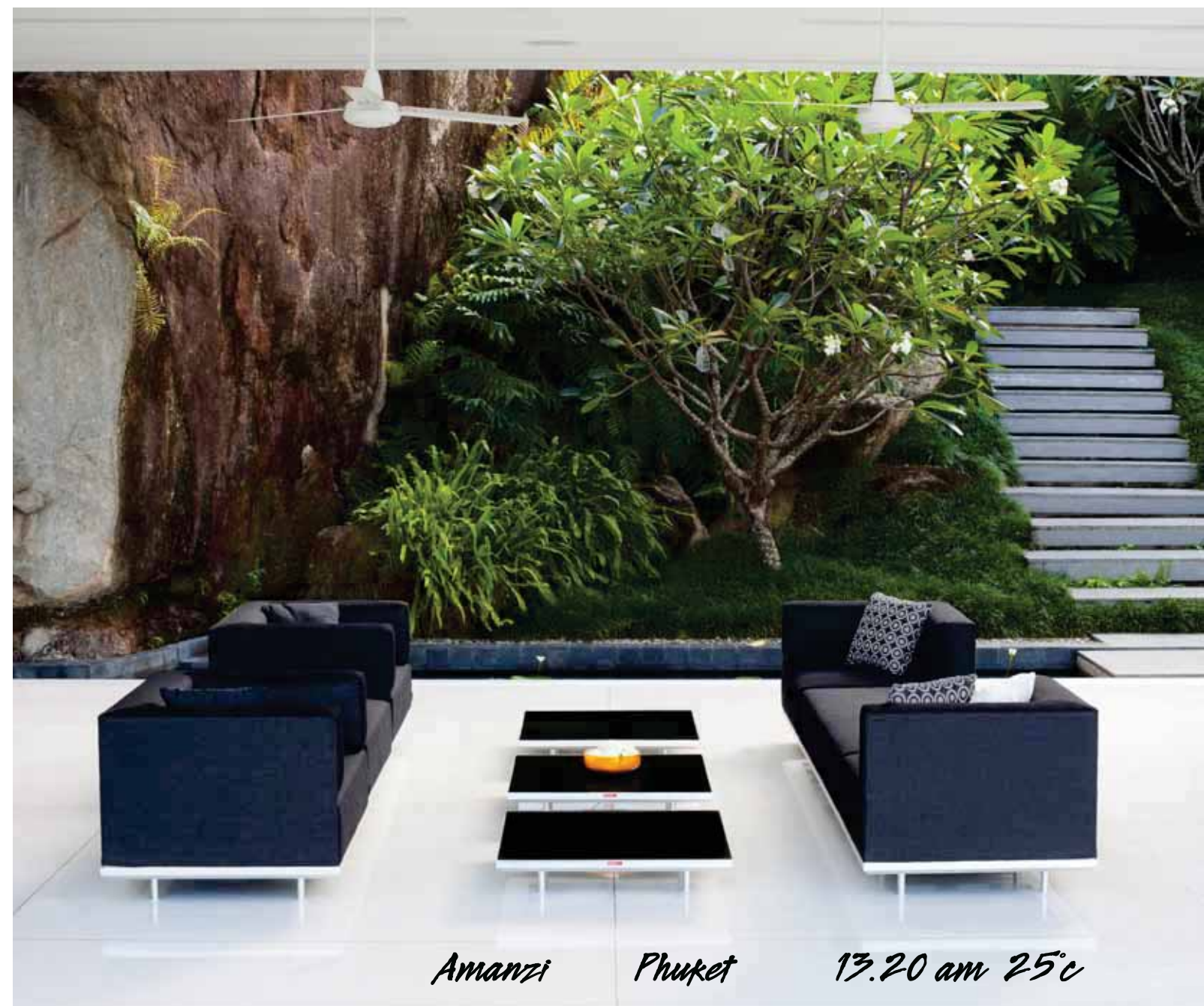

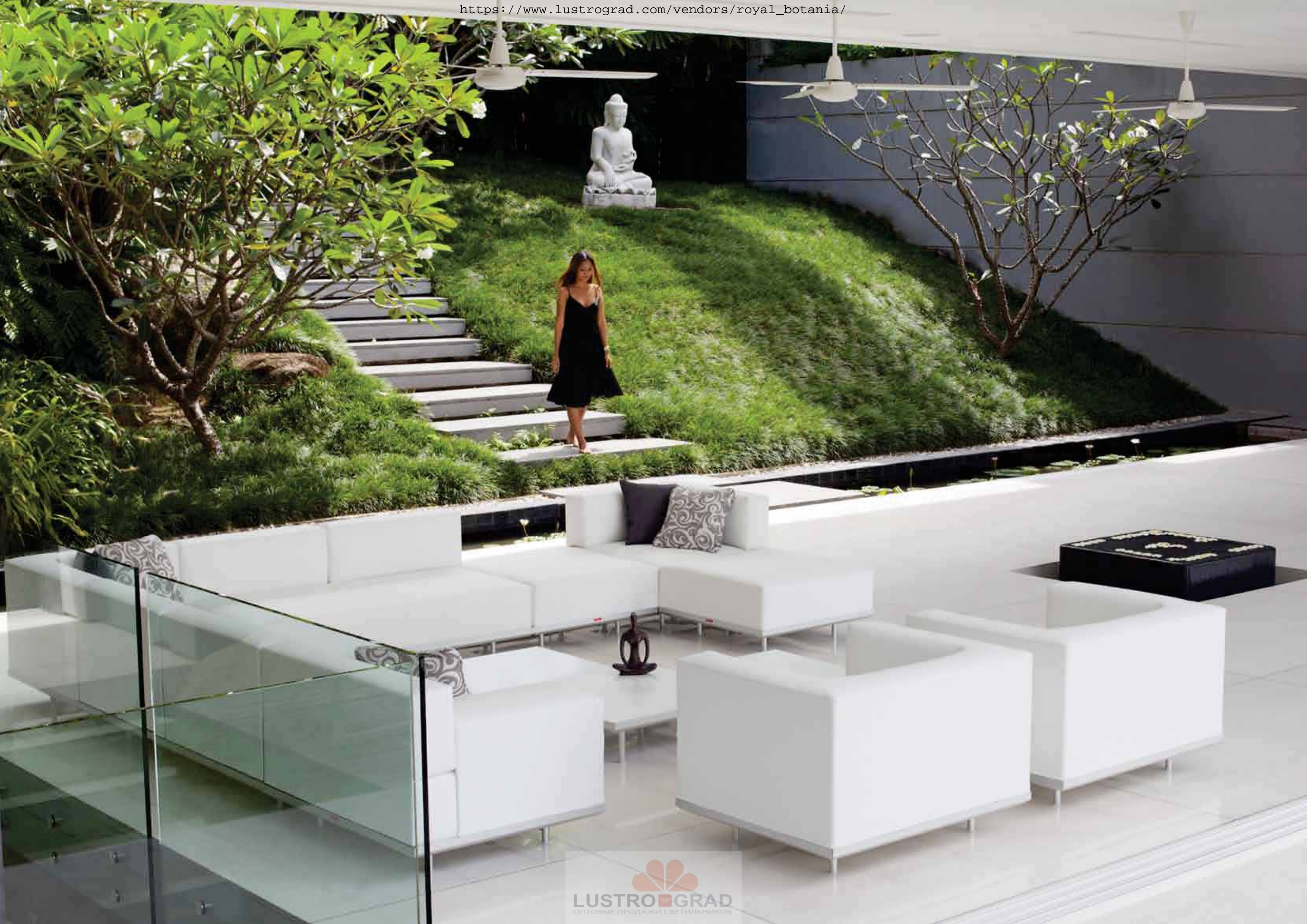

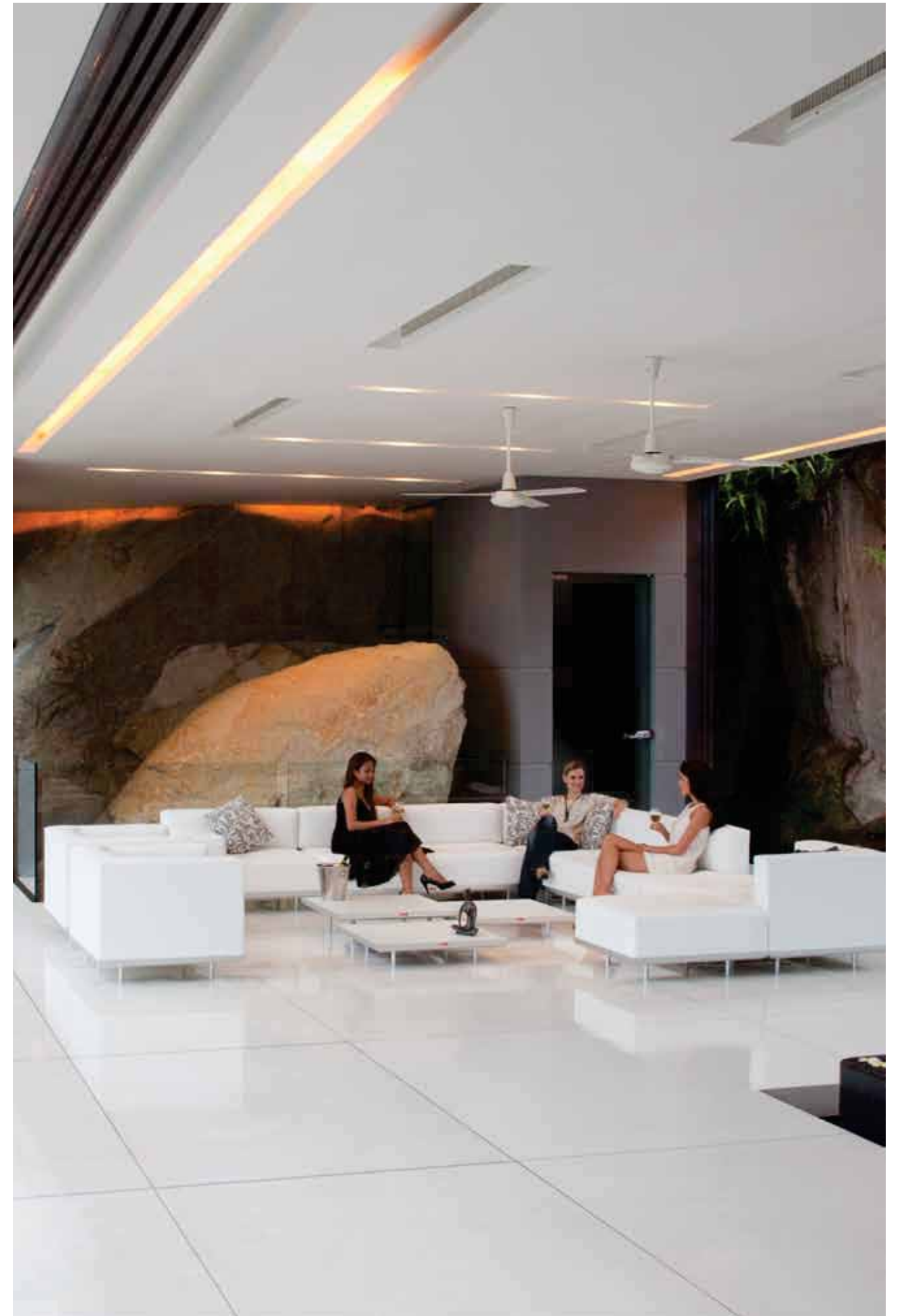

IT IS VERY DIFFICULT not to appreciate the unique refined shape of the QT. Even though comprising very slim stainless steel profiles, the concept has been carefully studied to not only offer maximal stability, looks and comfort, but also to ensure that both the chairs and the loungers are easily stackable. What other name to give these cute pieces, than.... QT ! IL SERAIT TRÈS DIFFICILE de ne pas apprécier la forme raffinée unique de ce fauteuil. Malgré le fait qu'ils sont composés de profils en acier inoxydable effilés, le concept a été élaboré pour offrir non seulement du confort, un look et de la stabilité, mais surtout, tant les chaises que les chaises longues sont empilables. Le nom QT était évident... ES IST SEHR SCHWIERIG die einmalig verfeinerte Form der QT nicht zu schätzen. Trotz der Tatsache, dass sie aus sehr schlanken Edelstahlprofilen bestehen, wurde das Konzept nicht nur erarbeitet um Komfort, Looks und Stabilität zu bieten, sondern auch erreicht, dass sowohl die Stühle als auch Liegestühle stapelbar sind. Der Name QT lag nahe... ZEER MOEILIJK OM de unieke verfijnde vorm van deze stoel niet te appreciëren. Ondanks het feit dat ze opgebouwd zijn uit zeer slanke roestvrijstalen profielen, werd het concept uitgewerkt om niet enkel comfort, looks en stabiliteit te bieden, maar bovendien werd er voor gezorgd dat zowel de stoelen als de ligbedden stapelbaar zijn. De naam QT lag voor de hand... DIFFICILISSIMO, non apprezzare la linea raffinata ed esclusiva di questi articoli. Sebbene siano realizzati con telai in acciaio inossidabile estremamente affusolati, il concept è stato elaborato non soltanto per offrire comfort, estetica e stabilità, ma anche per fare in modo che sia le sedie sia i lettini fossero impilabili. E non potevamo che chiamarli QT... ES MUY DIFÍCIL, no apreciar las formas refinadas y únicas de estos elementos. A pesar de consistir en perfiles de acero inoxidable realmente finos, el concepto ha sido estudiado cuidadosamente para ofrecer, no solamente una estabilidad, un diseño y un confort máximos, sino que además, tanto las sillas como las tumbonas pueden ser fácilmente apilables. ¿Y qué otro nombre podrían recibir estas piezas, sino... QT?

QT



Design: Kris Van Puyvelde

QT + SEXION





QT + TABOELA

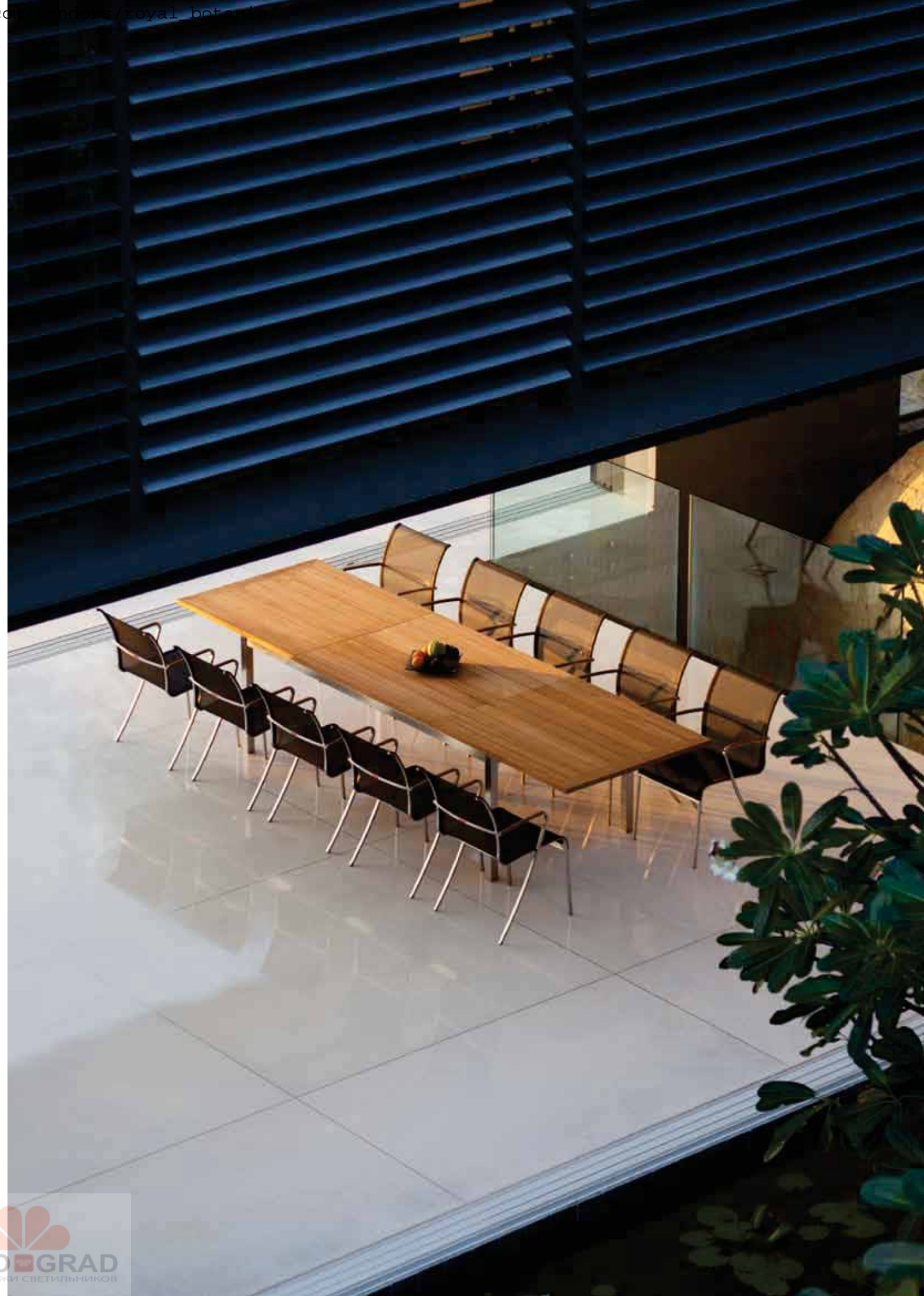

QT + TABOELA







Antiparos Greece 1.10 pm 29°C

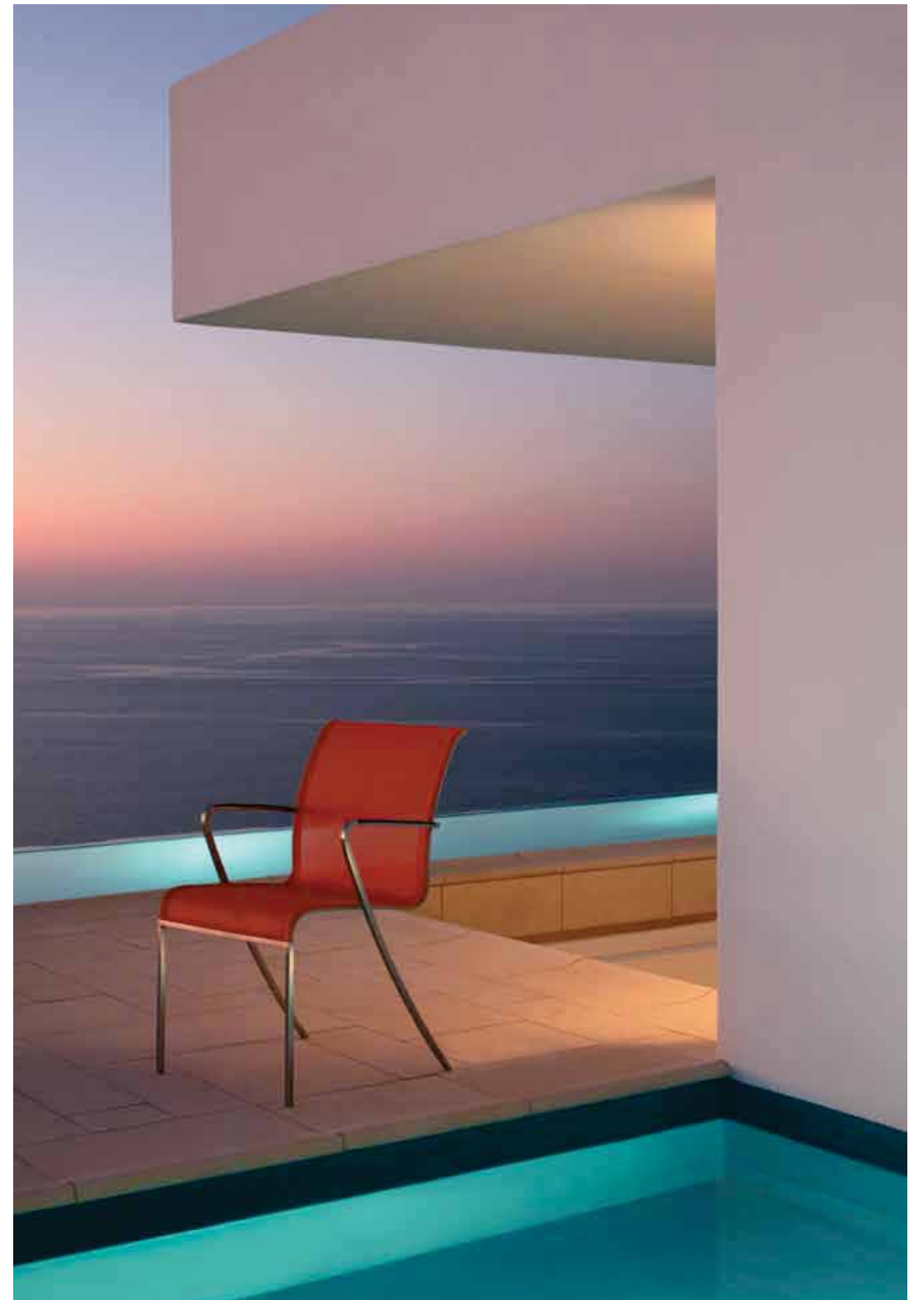

X Q I

WHAT MAKES THE XQI CHAIR EXQUISITE? Is it the perfectly balanced appearance? Is it the way the stainless steel frame is nicely integrated into the warm teakwood? Is it the superb comfort offered or the nice tables that compliment it? If you ask us, it is indeed all that, plus so much more! QU'EST-CE QUI REND LA CHAISE XQI AUSSI RAFFINÉE ? Est-ce son allure parfaitement équilibrée ? Est-ce la façon dont le cadre en acier inoxydable, est intégré de manière invisible dans le teck ? Est-ce le superbe confort qu'elle offre, ou les jolies tables qui vont avec ? Si vous nous posez la question, c'est en fait tout ça et beaucoup plus encore ! WAS MACHT DEN XQI STUHL SO ERLESEN? Ist es das perfekt abgerundete Erscheinungsbild? Ist es die Art, wie der Rahmen aus Edelstahl mühelos mit dem warmen Teakholz verschmilzt? Ist es der einzigartige Komfort oder sind es die passenden Tische, die ihn ergänzen? Wenn Sie uns fragen, ist es in der Tat all das und noch so viel mehr! WAT MAAKT DE XQI STOEL ZO EXQUISIT? Is het die perfect gebalanceerde verschijning? Is het de geraffineerde wijze waarop het roestvaststalen frame werd weggewerkt in het warme teakhout? Is het misschien het sublieme comfort, of de complementaire tafelcollectie. Volgens ons, is het inderdaad al dat, en nog zoveel meer! COSA RENDE DELIZIOSA LA SEDIA XQI? È che ha un'apparenza perfettamente bilanciata ? È il modo in cui il telaio in acciaio inossidabile si integra perfettamente nel caldo legno di teak? È il superbo comfort offerto, o la possibilità di abbinarle dei bellissimi tavoli? Se ce lo domandate, è senz'altro tutto questo, più molto altro ancora! ¿POR QUÉ ES LA SILLA XQI TAN EXQUISITA? ¿Es por su apariencia perfectamente equilibrada? ¿Es la forma en la que el marco de acero inoxidable se integra elegantemente con la cálida madera de teca? ¿Es la estupenda comodidad que ofrece o las preciosas mesas que la complementan? Si nos pregunta, ¡es por todo eso y mucho más!

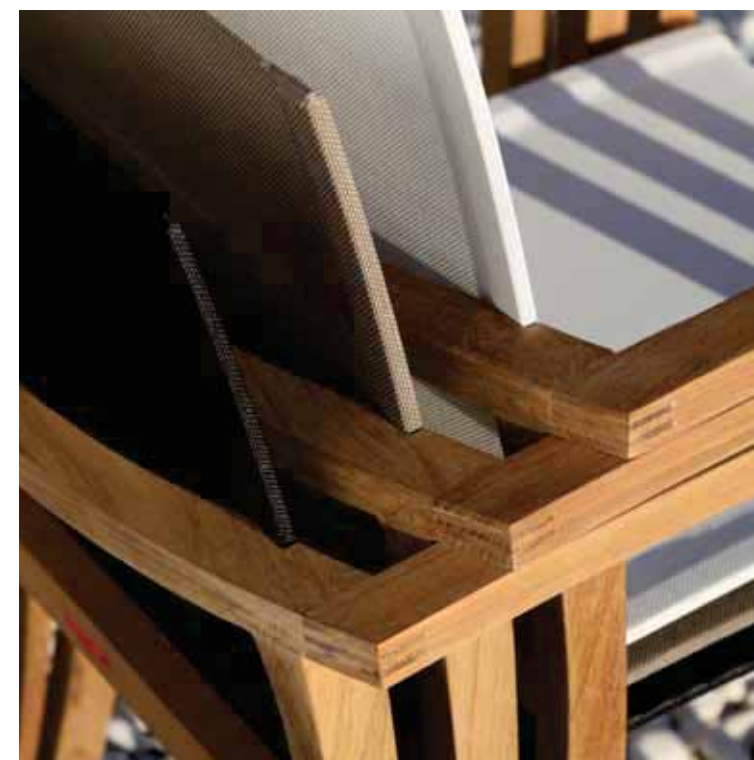

Design: Kris Van Puyvelde

X Q I



X Q I

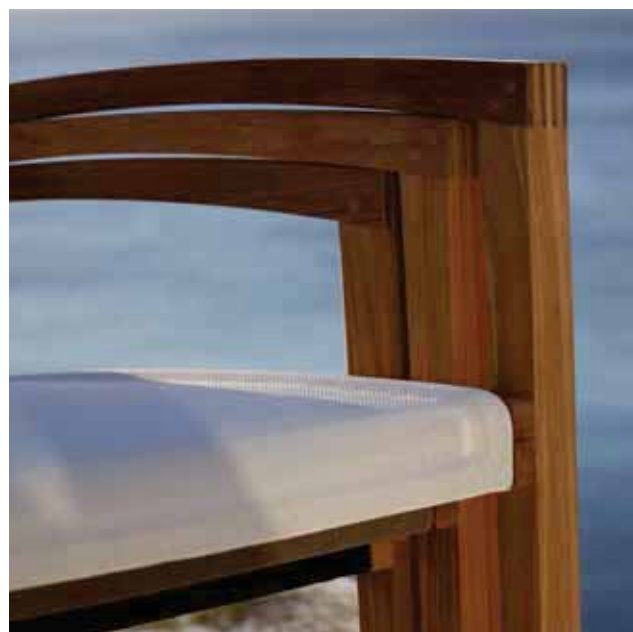







BEACHER



UMBRELLAS

WE CAME TOO LATE to invent the umbrella, but not to reinvent it. Looking at the fine woodwork, the shiny stainless steel fittings, the superb acrylic covers, you will realise, the Royal Botania umbrellas are way beyond what you have seen before. Sheer luxury. NOUS ARRIVONS TROP TARD pour inventer le parasol mais pas pour le réinventer. Regardez les détails graphiques des pièces en inox et la superbe toile acrylique, vous réaliserez que les parasols Royal Botania sont à un niveau de finition que vous n'aviez jamais vu auparavant. Le luxe à l'état pur. WIR KAMEN ZWAR ZU SPÄT, den Sonnenschirm zu erfinden, aber nicht zu spät um ihn neu zu erfinden. Richten Sie Ihr Augenmerk auf die feinen Holzarbeiten, das glänzende Edelstahl und auf die hervorragende Acryl-Bespannung. Die Sonnenschirme von Royal Botania stellen alles bisher Gesehene in den Schatten. Purer Luxus. WE KWAMEN TE LAAT om de parasol uit te vinden, dus hebben we hem heruitgevonden. Eén blik op het sublieme houtwerk, het glimmende beslag uit roestvast staal, het superieure textiel en u zult ongetwijfeld begrijpen wat we bedoelen. Pure Luxe. SIAMO ARRIVATI TROPPO TARDI per inventare l'ombrellone ma non troppo tardi per re-inventarlo. Guardando la fine lavorazione del legno, i lucenti particolari in acciaio inossidabile e le superbe coperture in acrilico capirete che gli ombrelloni Royal Botania sono oltre tutto quello che avete visto fino ad ora. Vero lusso. LLEGAMOS DEMASIADO TARDE para inventar la sombrilla, pero no para reinventarla. Fijándose en la excelente carpintería, los relucientes acabados de acero inoxidable, los magníficos toldos acrílicos, se dará cuenta de que las sombrillas Royal Botania exceden todas sus expectativas. Lujo puro.



SHADY-TEAK

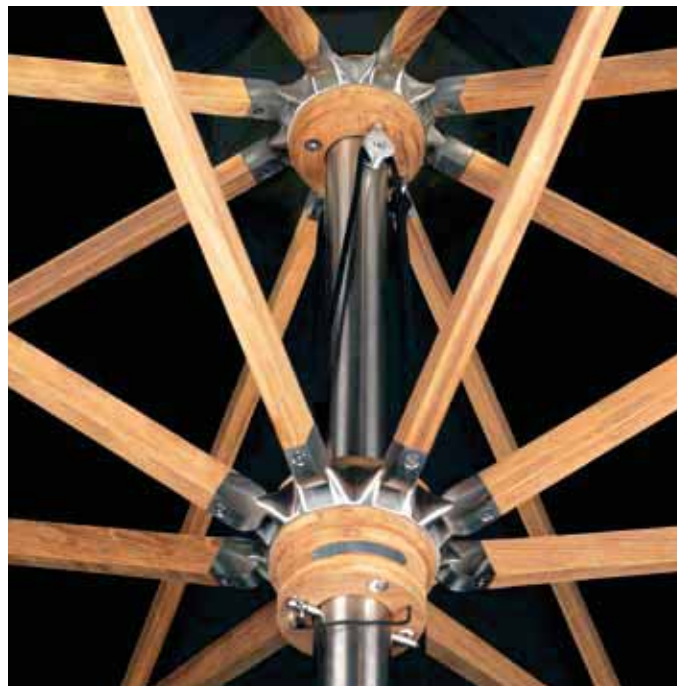

FEATURES

- Stainless steel pole ø 60 mm
- Stainless steel crown rings and fittings
- Double stainless steel pulley system with integrated ballbearings
- "A-grade" teak ribs and hubs
- cover solution dyed acrylic fibre 300gr/m²
- Cover easily removable
- Ribs easily exchangeable
- Deluxe storage bag included

CARACTERISTIQUES

- Mât de ø 60 mm en acier inoxydable sablé
- Coliers de couronnes et viserie en acier inoxydable
- Pouli double en acier inoxydable avec roulements intégrés
- Baleines et couronnes en "A-grade" teck
- Toile en fibre acrylique 300gr/m² teintée à coeur.
- Couverture facilement démontable
- Baleines facilement échangeables
- Housse de protection luxueux inclus

SPEZIFIKATIONEN

- Edelstahlmast mit Ø 60 mm Durchmesser
- Edelstahl-Kronen an den Schirmnaben und Edelstahl-Beschläge
- Doppelter Flaschenzug aus Edelstahl mit integrierten Kugellagern
- Schirmstreben und Schirmnaben aus erstklassigem Teakholz
- Bespannung aus 300gr/m² Polyacryl Lösung gefärbt.
- Bespannung leicht abziehbar
- Leicht auswechselbare Schirmstreben
- Inklusiv Deluxe-Schirmhülle

KENMERKEN

- Mast in roestvrij staal ø 60 mm
- Kroonringen en beslag in roestvrij staal
- Dubbel gelagerd katrolsysteem in roestvrij staal
- Ribben en kronen in "A-grade" teakhout
- Doek vervaardigd uit in de massa gekleurd acrylaat van 300 gr/m²
- Doek eenvoudig afneembaar
- Ribben eenvoudig vervangbaar
- Luxeuzer opberghoes inbegrepen

CARATTERISTICHE

- Palo in acciaio inossidabile diam. 60 mm
- Corone e accessori in acciaio inossidabile
- Doppia carrucola con cuscinetto a sfera in acciaio inossidabile
- Stecche e mozzi in legno teak di grado A
- Tessuto à poliacrilico 300gr/m² tinto in pasta.
- Tessuto facilmente rimovibile
- Stecche facilmente intercambiabili
- Telo di protezione Deluxe incluso

CARACTERISTICAS

- Mastil en acero inoxidable de 60 mm de diametro
- Aro de corona y accesorios en acero inoxidable
- Doble polea con cojinetes en acero inoxidable
- Corona y brazos en madera de teca "A"
- Acrilico 300gr/m² solución tintada
- Tela facilmente extraible
- Brazos facilmente recambiables
- Funda deluxe incluida

SHADY COLOURS (see p. 302-306)

	TEX WU	TEX EU	TEX TU	TEX BU	TEX GU
⊗ 3,5	SHA 35 WU	SHA 35 EU	SHA 35 TU	SHA 35 BU	SHA 35 GU
⊗ 4,5	SHA 45 WU	SHA 45 EU	SHA 45 TU	SHA 45 BU	SHA 45 GU
⊗ 3X3	SHA 30V WU	SHA 30V EU	SHA 30V TU	SHA 30V BU	SHA 30V GU
⊗ 3,5X3,5	SHA 35V WU	SHA 35V EU	SHA 35V TU	SHA 35V BU	SHA 35V GU
⊗ 3X4	SHA 40R WU	SHA 40R EU	SHA 40R TU	SHA 40R BU	SHA 40R GU

	TEX MU	TEX GRU	TEX CAU	TEX FOU	TEX ZU
⊗ 3,5	SHA 35 MU	SHA 35 GRU	SHA 35 CAU	SHA 35 FOU	SHA 35 ZU
⊗ 4,5	SHA 45 MU	SHA 45 GRU	SHA 45 CAU	SHA 45 FOU	SHA 45 ZU
⊗ 3X3	SHA 30V MU	SHA 30V GRU	SHA 30V CAU	SHA 30V FOU	SHA 30V ZU
⊗ 3,5X3,5	SHA 35V MU	SHA 35V GRU	SHA 35V CAU	SHA 35V FOU	SHA 35V ZU
⊗ 3X4	SHA 40R MU	SHA 40R GRU	SHA 40R CAU	SHA 40R FOU	SHA 40R ZU

68,74,75,152,154

SHADY-ALUMINIUM



FEATURES

- Aluminium pole ø 60 mm
- Stainless steel crown rings and fittings
- Double stainless steel pulley system with integrated ballbearings
- Aluminium ribs
- Hubs coated wood
- Cover solution dyed acrylic fibre 300gr/m² / cover in Batyline®
- Cover easily removable
- Ribs easily exchangeable
- Deluxe storage bag included

KENMERKEN

- Mast in aluminium ø 60 mm
- Kroonringen en beslag in roestvrij staal
- Dubbel gelagerd katrolsysteem in roestvrij staal
- Ribben uit aluminium
- Kronen uit gelakt hout
- Doek vervaardigd uit in de massa gekleurd acrylaat van 300 gr/m² / doek in Batyline®
- Doek eenvoudig afneembaar
- Ribben eenvoudig vervangbaar
- Luxe opberghoes inbegrepen

CARACTERISTIQUES

- Mât de ø 60 mm en aluminium
- Coliers de couronnes et viserie en acier inoxydable
- Pouli double en acier inoxydable avec roulements intégrés
- Baleines en aluminium
- Couronnes en bois lacqué
- Toile en fibre acrylique 300gr/m² teintée à coeur / toile en Batyline®
- Couverture facilement démontable
- Baleines facilement échangeables
- Housse de protection luxueux inclus

CARATTERISTICHE

- Palo in alluminio diam. 60 mm
- Corone e accessori in acciaio inossidabile
- Doppia carrucola con cuscinetto a sfera in acciaio inossidabile
- Stecche in alluminio
- Mozzi in legno verniciato
- Tessuto à poliacrilico 300gr/m² tinto in pasta / Tessuto à Batyline®
- Tessuto facilmente rimovibile
- Stecche facilmente intercambiabili
- Telo di protezione Deluxe incluso

SPEZIFIKATIONEN

- Aluminiummast mit Ø 60 mm Durchmesser
- Edelstahl-Kronen an den Schirmnaben und Edelstahl-Beschläge
- Doppelter Flaschenzug aus Edelstahl mit integrierten Kugellagern
- Schirmstreben und Aluminium
- Schirrnaben aus lackiertem Holz
- Bespannung aus 300gr/m² Polyacryl Lösung gefärbt / Bespannung aus Batyline®
- Bespannung leicht abziehbar
- Leicht auswechselbare Schirmstreben
- Inklusiv Deluxe-Schirmhülle

CARACTERISTICAS

- Mastil en aluminio de 60 mm de diametro
- Aro de corona y accesorios en acero inoxidable
- Doble polea con cojinetes en acero inoxidable
- Brazos en aluminio
- Coronas en madera pintada
- Acrílico 300gr/m² solución tintada / Batyline®
- Tela facilmente extraible
- Brazos facilmente recambiables
- Funda deluxe incluida

SHADY ALUMINIUM COLOURS (see p. 302-306)

	TEX WU	BAT WU	TEX CAU	BAT CAU	TEX ZU	BAT ZU
⊗ 3,5	SHA 35 WW	SHA 35 TWW	SHA 35 CC	SHA 35 TCC	SHA 35 BB	SHA 35 TBB
⊗ 4,5	SHA 45 WW	SHA 45 TWW	SHA 45 CC	SHA 45 TCC	SHA 45 BB	SHA 45 TBB
⊗ 3X3	SHA 30V WW	SHA 30V TWW	SHA 30V CC	SHA 30V TCC	SHA 30V BB	SHA 30V TBB
⊗ 3,5X3,5	SHA 35V WW	SHA 35V TWW	SHA 35V CC	SHA 35V TCC	SHA 35V BB	SHA 35V TBB
⊗ 3X4	SHA 40R WW	SHA 40R TWW	SHA 40R CC	SHA 40R TCC	SHA 40R BB	SHA 40R TBB

TEX = textile

BAT = Batyline®

SHADY X-CENTRIC TEAK



FEATURES

- Stainless steel frame, crown rings and fittings.
- Incorporated winch system
- A-grade teak woodwork
- 360° rotatable on base.
- cover easily removable.
- ribs easily exchangeable.
- cover solution dyed acrylic fibre 300gr/m²
- deluxe storage bag included.
- heavy duty (90 x 90 cm / 220 kg) granite base included
- Possibility to replace granite base by stainless steel anchor for installation into the terrace floor, or by MOBY-X base (see p. 261)

KENMERKEN

- Frame, kronen en fittings uit roestvrij staal
- Geïntegreerd optreksysteem.
- Houtwerk in A-grade teak
- 360° roteerbaar op voetplaat
- Doek eenvoudig afneembaar
- Ribben makkelijk vervangbaar
- Doek vervaardigd uit in de massa gekleurd acrylaat van 300 gr/m²
- Deluxe hoes inbegrepen.
- Voetplaat (90 x 90 cm / 220 kg) in donker graniet inbegrepen
- Er bestaat de mogelijkheid de granieten voetplaat te vervangen door een RVS anker ter inbouw in de terrasvloer, of door de MOBY-X (zie p. 261)

CARACTERISTIQUES

- Support et autres pièces métalliques en acier inoxydable.
- Manivelle intégrée pour l'ouverture et la fermeture du parasol.
- Toutes les parties en bois sont en Teck de première qualité.
- Parasol sur support mobile à 360° sur la base.
- Toile facilement amovible.
- Baleines en teck facilement remplaçables.
- Toile en fibre acrylique 300gr/m² teintée à coeur.
- Housse de protection incluse.
- Base carrée (90 x 90 cm / 220 kg) en granit noir massif incluse.
- Possibilité d'embase en acier inoxydable à sceller dans le béton. (en remplacement de la base en granit)
- Possibilité de remplacer la base en granit, par la base MOBY-X; (voir p. 261)

CARATTERISTICHE

- Palo , corone e accessori in acciaio inossidabile
- Apertura a manovella. Il cavo è posizionato all'interno del palo.
- L'ombrellone può ruotare di 360° sulla base
- Stecche e mozzi in legno teak di grado A
- Stecche facilmente intercambiabili
- Tessuto poliacrilico 300gr/m² tinto in pasta.
- Tessuto facilmente rimovibile.
- Telo di protezione Deluxe incluso
- Base in granito (90 x 90 cm / 220 kg) inclusa
- Possibilità di sostituire la base di granito con una staffa ficcone in acciaio inossidabile per il fissaggio nel terreno, o con MOBY-X (p. 261)

EIGENSCHAFTEN

- Mast, Kronen an den Schirrnaben und Beschläge aus Edelstahl.
- Enthaltene Kurbelsystem
- Schirm 360° drehbar auf Sockel.
- Schirmstreben und Schirrnaben aus erstklassigem Teakholz.
- Leicht auswechselbare Schirmstreben.
- Bespannung aus 300gr/m² Polyacryl Lösung gefärbt.
- Bespannung leicht abziehbar.
- Inklusive hochbelastbarem (90 x 90 cm / 220 kg) Granitsockel
- Granitsockel kann durch rostfreie Stahlverankerung zur Installation in den Terrassenfußboden ausgetauscht werden.
- Granitsockel kann durch MOBY-X (siehe seite p. 261) ausgetauscht werden.

CARACTERISTICAS

- Mastil, Aro de corona y accesorios en acero inoxidable
- sistema de polea incorporado
- rotatable 360°
- Corona y brazos en madera de teca "A"
- Brazos facilmente extraible
- Acrilico 300gr/m² solución tintada
- Tela facilmente extraible
- funda deluxe incluida
- Base de granite incluida (90 x 90 cm / 220 kg)
- Posibilidad de sustituir la base de granito por estaca para instalación en el suelo, o por la MOBY-X (p. 261)

SHADY X-CENTRIC COLOURS (see p. 302-306)

TEX
WU

TEX
EU

TEX
TU

TEX
BU

TEX
GU

4,0
3X4

SHAX 40 WU
SHAX 40R WU

SHAX 40 EU
SHAX 40R EU

SHAX 40 TU
SHAX 40R TU

SHAX 40 BU
SHAX 40R BU

SHAX 40 GU
SHAX 40R GU

TEX
MU

TEX
GRU

TEX
CAU

TEX
FOU

TEX
ZU

4,0
3X4

SHAX 40 MU
SHAX 40R MU

SHAX 40 GRU
SHAX 40R GRU

SHAX 40 CAU
SHAX 40R CAU

SHAX 40 FOU
SHAX 40R FOU

SHAX 40 ZU
SHAX 40R ZU

SHADY X - CENTRIC ALUMINIUM



FEATURES

- Stainless steel frame, crown rings and fittings.
- Incorporated winch system
- Aluminium ribs
- Hubs coated wood
- 360° rotatable on base.
- cover easily removable.
- ribs easily exchangeable.
- cover solution dyed acrylic fibre 300gr/m² / cover in Batyline®
- deluxe storage bag included.
- heavy duty (90 x 90 cm / 220 kg) granite base included
- Possibility to replace granite base by stainless steel anchor for installation into the terrace floor, or by MOBY-X base (see p. 261)

KENMERKEN

- Frame, kronen en fittings uit roestvrij staal
- Geïntegreerd optreksysteem.
- Ribben uit aluminium
- Kronen uit gelakt hout
- 360° roterbaar op voetplaat
- Doek eenvoudig afneembaar
- Ribben makkelijk vervangbaar
- Doek vervaardigd uit in de massa gekleurd acrylaat van 300 gr/m² / doek in Batyline®
- Deluxe hoes inbegrepen.
- Voetplaat (90 x 90 cm / 220 kg) in donker graniet inbegrepen
- Er bestaat de mogelijkheid de granieten voetplaat te vervangen door een RVS anker ter inbouw in de terrasvloer, of door de MOBY-X (zie p. 261)

CARACTERISTIQUES

- Support et autres pièces métalliques en acier inoxydable.
- Manivelle intégrée pour l'ouverture et la fermeture du parasol.
- Baleines en aluminium
- Couronnes en bois lacqué
- Parasol sur support mobile à 360° sur la base.
- Toile facilement amovible.
- Baleines en teck facilement remplaçables.
- Toile en fibre acrylique 300gr/m² teintée à cœur / toile en Batyline®
- Housse de protection incluse.
- Base carrée (90 x 90 cm / 220 kg) en granit noir massif incluse.
- Possibilité d'embase en acier inoxydable à sceller dans le béton. (en remplacement de la base en granit)
- Possibilité de remplacer la base en granit, par la base MOBY-X; (voir p. 261)

CARATTERISTICHE

- Palo , corone e accessori in acciaio inossidabile
- Apertura a manovella. Il cavo è posizionato all'interno del palo.
- L'ombrellone può ruotare di 360° sulla base
- Stecche in alluminio
- Mozzi in legne verniciato
- Stecche facilmente intercambiabili
- Tessuto poliacrilico 300gr/m² tinto in pasta / Tessuto à Batyline®
- Tessuto facilmente rimovibile.
- Telo di protezione Deluxe incluso
- Base in granito (90 x 90 cm / 220 kg) inclusa
- Possibilità di sostituire la base di granito con una staffa ficcone in acciaio inossidabile per il fissaggio nel terreno, o con MOBY-X (p. 261)

EIGENSCHAFTEN

- Mast, Kronen an den Schirmnaben und Beschläge aus Edelstahl.
- Enthaltene Kurbelsystem
- Schirm 360° drehbar auf Sockel.
- Schirmstreben und Aluminium
- Schirmnaben aus lackiertem Holz
- Leicht auswechselbare Schirmstreben.
- Bespannung aus 300gr/m² Polyacryl Lösung gefärbt / Bespannung aus Batyline®
- Bespannung leicht abziehbar.
- Inklusive hochbelastbarem (90 x 90 cm / 220 kg) Granitsockel
- Granitsockel kann durch rostfreie Stahlverankerung zur Installation in den Terrassenfußboden ausgetauscht werden.
- Granitsockel kann durch MOBY-X (siehe seite p. 261) ausgetauscht werden.

CARACTERISTICAS

- Mastil, Aro de corona y accesorios en acero inoxidable
- sistema de polea incorporado
- rotatable 360°
- Brazos en aluminio
- Coronas en madera pintada
- Brazos facilmente extraible
- Acrilico 300gr/m² solución tintada / Batyline®
- Tela facilmente extraible
- funda deluxe incluida
- Base de granite incluida (90 x 90 cm / 220 kg)
- Posibilidad de sustituir la base de granito por estaca para instalación en el suelo, o por la MOBY-X (p. 261)

SHADY X - CENTRIC ALUMINIUM COLOURS (see p. 302-306)

TEX
WU

BAT
WU

TEX
CAU

BAT
CAU

TEX
ZU

BAT
ZU

4,0

SHAX 40 WW

SHAX 40 TWW

SHAX 40 CC

SHAX 40 TCC

SHAX 40 BB

SHAX 40 TBB

3X4

SHAX 40R WW

SHAX 40R TWW

SHAX 40R CC

SHAX 40R TCC

SHAX 40R BB

SHAX 40R TBB

TEX = textile

BAT = Batyline®



FEATURES

- Nyatoh pole (Ø 60 mm) and ribs
- Stainless steel crown rings and fittings
- Double stainless steel pulley system with integrated ballbearings
- Varnished teak hubs and top
- cover solution dyed acrylic fibre 300gr/m²
- Cover easily removable
- Ribs easily exchangeable
- Deluxe storage bag included

CARACTERISTIQUES

- Mât (Ø 60 mm) et baleines en Nyatoh
- Coliers de couronnes et viserie en acier inoxydable
- Pouli double en acier inoxydable avec roulements intégrés
- Couronnes en teck laqué
- Toile en fibre acrylique 300gr/m² teintée à coeur.
- Couverture facilement démontable
- Baleines facilement échangeables
- Housse de protection luxueux inclus

EIGENSCHAFTEN

- Mast (Ø 60 mm) und Streben aus Nyatoh
- Edelstahl-Kronen an den Schirmnaben und Edelstahl-Beschläge
- Doppelter Flaschenzug aus Edelstahl mit integrierten Kugellagern
- Schirmnaben aus lackietem Teakholz
- Bespannung aus 300gr/m² Polyacryl Lösung gefärbte.
- Bespannung leicht abziehbar
- Leicht auswechselbare Schirmstreben
- Inklusiv Deluxe-Schirmhülle

KENMERKEN

- Mast (Ø 60 mm) en ribben in Nyatoh
- Kroonringen en beslag in roestvrij staal
- Dubbel gelagerd katrolsysteem in roestvrij staal
- Kronen en top in vernist teakhout
- Doek vervaardigd uit in de massa gekleurd acrylaat van 300 gr/m²
- Doek eenvoudig afneembaar
- Ribben eenvoudig vervangbaar
- Luxeuzer opberghoes inbegrepen

CARATTERISTICHE

- Palo (diam. 60 mm) e stecche in Nyatoh
- Corone e accessori in acciaio inossidabile
- Doppia carrucola con cuscinetto a sfera in acciaio inossidabile
- Mozzi in legno teak
- Tessuto polyacryl 300gr/m² tinto in pasta.
- Tessuto facilmente rimovibile
- Stecche facilmente intercambiabili
- Telo di protezione Deluxe incluso

CARACTERISTICAS

- Mastil (diam. 60 mm) y brazos en Nyatoh
- Aro de corona y accesorios en acero inoxidable
- Doble polea con cojinetes en acero inoxidable
- Corona en madera de teca
- Acrílico 300gr/m² solución tintada
- Tela facilmente extraible
- Brazos facilmente recambiables
- Funda deluxe incluida

C E Y L O N C O L O U R S (see p. 302-306)

TEX WU

TEX EU

TEX TU

TEX BU

TEX GU

- ⊗ **3,0**
- ⊗ **3,5**
- ⊗ **3X3**
- ⊗ **3x4**

CEY 30 WU
CEY 35 WU
CEY 30V WU
CEY 40R WU

CEY 30 EU
CEY 35 EU
CEY 30V EU
CEY 40R EU

CEY 30 TU
CEY 35 TU
CEY 30V TU
CEY 40R TU

CEY 30 BU
CEY 35 BU
CEY 30V BU
CEY 40R BU

CEY 30 GU
CEY 35 GU
CEY 30V GU
CEY 40R GU

TEX MU

TEX GRU

TEX CAU

TEX FOU

TEX ZU

- ⊗ **3,0**
- ⊗ **3,5**
- ⊗ **3X3**
- ⊗ **3X4**

CEY 30 MU
CEY 35 MU
CEY 30V MU
CEY 40R MU

CEY 30 GRU
CEY 35 GRU
CEY 30V GRU
CEY 40R GRU

CEY 30 CAU
CEY 35 CAU
CEY 30V CAU
CEY 40R CAU

CEY 30 FOU
CEY 35 FOU
CEY 30V FOU
CEY 40R FOU

CEY 30 ZU
CEY 35 ZU
CEY 30V ZU
CEY 40R ZU

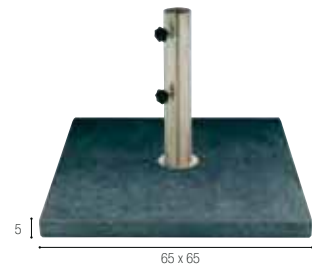

CEY V 70 BP

- Black granite
- Granit Noir
- Schwarzer Granit
- Zwart graniet
- Granito nero
- Granito negro

54 kg

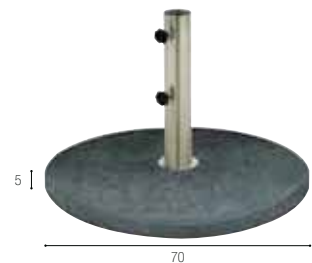

CEY V 70 RG

- Black granite
- Granit Noir
- Schwarzer Granit
- Zwart graniet
- Granito nero
- Granito negro

43 kg



CEY V 70 G

- Granite
- Granit
- Granit
- Graniet
- Granito
- Granito

54 kg

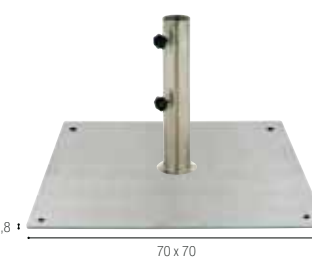

**CEY V 70 IP
CEY V 70 IPEP(*)**

- Polished stainless steel
- Acier inoxydable poli
- Gebürsteter Edelstahl
- Geslepen roestvrij staal
- Acciaio inox spazzolato
- Acero inoxidable pulido

34 kg

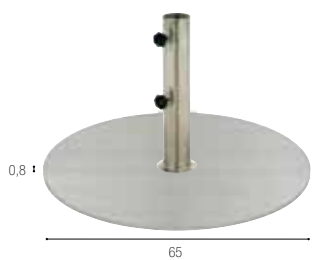

**CEY V 70 RIP
CEY V 70 RIPEP(*)**

- Polished stainless steel
- Acier inoxydable poli
- Gebürsteter Edelstahl
- Geslepen roestvrij staal
- Acciaio inox spazzolato
- Acero inoxidable pulido

21 kg



**CEY V 60 IPC
CEY V 60 IPCEP(*)**

- Polished stainless steel tube + concrete
- Tube en acier inoxydable poli + béton
- Schirm-Hülse aus gebürsteten Edelstahl + Beton
- Buis in geslepen roestvrij staal + beton
- Tubo in acciaio inox spazzolato + calcestruzzo
- Tubo en acero inoxidable pulido + hormigón

63 kg

CEY V X EP (*)

- Polished stainless steel - for CEY V 70 BP & CEY V 70 G
- Acier inoxydable poli - pour CEY V 70 BP & CEY V 70 G
- Gebürsteter Edelstahl - für CEY V 70 BP & CEY V 70 G
- Geslepen roestvrij staal - voor CEY V 70 BP & CEY V 70 G
- Acciaio inox spazzolato - per CEY V 70 BP & CEY V 70 G
- Acero inoxidable pulido - para CEY V 70 BP & CEY V 70 G



**CEY T 65 IP
CEY T 65 IPEP (*)**

- Polished stainless steel tube ø 65
- Tube en acier inoxydable poli ø 65
- Schirm-Hülse aus gebürsteten Edelstahl ø 65
- Buis in geslepen roestvrij staal ø 65
- Tubo in acciaio inox spazzolato ø 65
- Tubo en acero inoxidable pulido ø 65



**CEY T 65 IP
CEY T 65 IPEP (*)**

- Polished stainless steel tube ø 65
- Tube en acier inoxydable poli ø 65
- Schirm-Hülse aus gebürsteten Edelstahl ø 65
- Buis in geslepen roestvrij staal ø 65
- Tubo in acciaio inox spazzolato ø 65
- Tubo en acero inoxidable pulido ø 65



**CEY T 65 IP
CEY T 65 IPEP (*)**

- Polished stainless steel tube ø 65
- Tube en acier inoxydable poli ø 65
- Schirm-Hülse aus gebürsteten Edelstahl ø 65
- Buis in geslepen roestvrij staal ø 65
- Tubo in acciaio inox spazzolato ø 65
- Tubo en acero inoxidable pulido ø 65



**CEY T 65 IP
CEY T 65 IPEP (*)**

- Polished stainless steel tube ø 65
- Tube en acier inoxydable poli ø 65
- Schirm-Hülse aus gebürsteten Edelstahl ø 65
- Buis in geslepen roestvrij staal ø 65
- Tubo in acciaio inox spazzolato ø 65
- Tubo en acero inoxidable pulido ø 65



**CEY T 65 IP
CEY T 65 IPEP (*)**

- Polished stainless steel tube ø 65
- Tube en acier inoxydable poli ø 65
- Schirm-Hülse aus gebürsteten Edelstahl ø 65
- Buis in geslepen roestvrij staal ø 65
- Tubo in acciaio inox spazzolato ø 65
- Tubo en acero inoxidable pulido ø 65



**CEY T 65 IP
CEY T 65 IPEP (*)**

- Polished stainless steel tube ø 65
- Tube en acier inoxydable poli ø 65
- Schirm-Hülse aus gebürsteten Edelstahl ø 65
- Buis in geslepen roestvrij staal ø 65
- Tubo in acciaio inox spazzolato ø 65
- Tubo en acero inoxidable pulido ø 65

CEY V W EP (*)

- Stainless steel - for CEY V 70 IP
- Inoxydable poli - pour CEY V 70 IP
- Edelstahl - für CEY V 70 IP
- Roestvrij staal - voor CEY V 70 IP
- Acciaio inox - per CEY V 70 IP
- Acero inoxidable - para CEY V 70 IP



CEY T 65 T

- For table frame Leyton + Westham ø 65
- Pour base de table Leyton + Westham ø 65
- Für Tisch Leyton + Westham ø 65
- Voor tafel Leyton + Westham ø 65
- Per tavolo Leyton + Westham ø 65
- Para estructura de mesa Leyton + Westham ø 65



**CEY T 65 IPL
CEY T 65 IPLEP (*)**

- Long polished stainless steel tube- for OZN 130 HLS & OZN 160 HLS
- Tube long en acier inoxydable poli - pour OZN 130 HLS & OZN 160 HLS
- Lange Schirm-Hülse aus gebürsteten Edelstahl - für OZN 130 HLS & OZN 160 HLS
- Lange buis in geslepen roestvrij staal - voor OZN 130 HLS & OZN 160 HLS
- Tubo lungo in acciaio inox spazzolato - per OZN 130 HLS & OZN 160 HLS
- Tubo lungo en acero inoxidable pulido - para OZN 130 HLS & OZN 160 HLS



CEY P

- Spike - Zinc plated steel
- Pointe - acier zingué
- Erdspließ - Verzinkter Stahl
- Grondpin - Verzinkt staal
- Staffa ficcone - Acciaio zincato
- Estaca - Acero zincado

MOBY

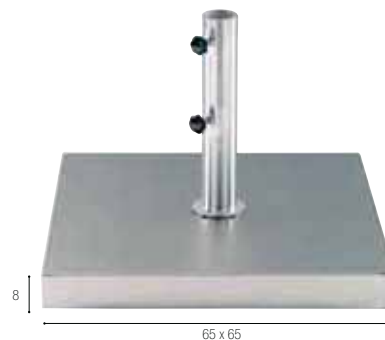

MOB 65

MOB 65 EP (*)

FEATURES

- Brushed stainless steel body
- Nylon wheels and detachable handle for moving around on the terrace
- To be filled with gravel for added weight
- Polished stainless steel tube included

CARACTERISTICUES

- Socle et tube en acier inoxydable poli
- Roulettes en nylon dur et manivelle démontable, facilitant le déplacement
- A remplir avec gravier pour augmenter le poids
- Tube en acier inoxydable poli inclus

SPEZIFIKATIONEN

- Korpus aus gebürstetem Edelstahl
- Nylonbereifung und ein abnehmbarer Griff für die freie Beweglichkeit
- Wird mit Kies befüllt, um das Gewicht zu erhöhen
- Hülse aus gebürsteten Edelstahl inklusiv

KENMERKEN

- Behuizing geslepen roestvrij staal
- Nylon wielen en afneembaar handvat voor een eenvoudige verplaatsing
- Te vullen met kiezel voor extra gewicht
- Buis in geslepen roestvrij staal inbegrepen

CARATTERISTICHE

- Corpo in acciaio inox
- Ruote in nylon staccabili manualmente per facili spostamenti
- Essere riempito con ghiaia per aggiungere peso
- Tubo in acciaio inox spazzolato incluso

CARACTERISTICAS

- Cuerpo en acero inoxidable pulido
- Ruedas de Nylon y mango desmontable para mover por la terraza
- Para rellenarse con grava para pesa adicional
- Tubo en acero inoxidable pulido incluido

23 kg + balast



MOBY X-CENTRIC (only for use with SHADY X-CENTRIC)

StSt

ALU W

ALU C

ALU B

**MOB X
MOB X EP (*)**

MOB X W

MOB X C

MOB X B

FEATURES

- Stainless steel or coated aluminium cover
- Nylon wheels and detachable handle for moving around on the terrace
- Concrete weights included

CARACTERISTICUES

- Couverture en acier inoxydable ou aluminium coloré
- Roulettes en nylon dur et manivelle démontable, facilitant le déplacement
- Poids en béton inclus

SPEZIFIKATIONEN

- Kappe aus Edelstahl oder Aluminium
- Nylonbereifung und ein abnehmbarer Griff für die freie Beweglichkeit
- Inklusiv Betonteilen

KENMERKEN

- Afdekkap uit roestvrij staal of gelakt aluminium
- Nylon wielen en afneembaar handvat voor een eenvoudige verplaatsing
- Betonelementen inbegrepen

CARATTERISTICHE









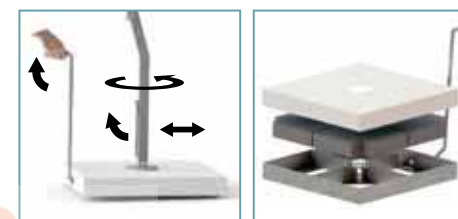





















- Copercio in acciaio inox o alluminio
- Ruote in nylon staccabili manualmente per facili spostamenti
- Peso in calcestruzzo incluso

CARACTERISTICAS

- Copertura en acero inoxidable y aluminio recubiertos
- Ruedas de Nylon y mango desmontable para mover por la terraza
- Peso en hormigón incluida

188 kg



	Batylne®
	Stainless Steel / L'acier inoxydable / Edelstahl Roestvast Staal / Acciaio inossidabile / Acero inoxidable
	Aluminium / Aluminium / Aluminium / Aluminium / Alluminio / Alumino
	Acrylic / Acrylate / Acrylat / Acrylaat / Acrilico / Acrilato
	High pressure laminate / Stratifié haute pression / Hochdrucklaminat Hoge druk laminaat / Laminato ad alta pressione / Laminado a alta presión
	CoaXXs®
	Glass / Verre / Glas / Glas / Vetro / Vidrio
	Teak / Teck / Teak / Teakholz / Teak / Teca
	Mahogany/Acajou/Mahagonie/Mahonie/Mogano/Caoba
	Oiled wood / Bois huilé / Geöltem Holz Geolied hout / Legno oliato / Madera engrasada
	Solid Surface Material / Matériaux Solid Surface / Solid Surface Material Solid Surface Materiaal / Materiali Solid surface / Materiales Solid Surface
	Ceramic / Céramique / Keramik / Keramiek / Ceramica / Cerámica
	Fabrics / Tissus / Stoffen / Stoffen / Tessuti / Telas
	Coated Wood / Bois revêtu / Beschichtetes Holz Gecoat hout / Legno rivestito / Madera recubiertos
	Coated Stainless Steel / L'acier inoxydable revêtu / Beschichtetes Edelstahl Gecoat Roestvast Staal / Acciaio inossidabile rivestito / Acero inoxidable recubiertos
	Polypropylene / Polypropylène / Polypropylen Polypropyleen / Polipropileno / Polipropylene
	Granite / Granit / Graniet / Graniet / Granita / Granito
	Polyethylene / Polyéthylène / Polyethylen Polyethyleen / Polietileno / Polietilene
	Polyvinyl chloride / Polychlorure de vinyle / Polyvinylchlorid Polyvinylchloride / Policloruro de vinilo / Cloruro di polivinile
	Packing volume / Volume d'emballage / Packvolumen Pakvolume / Volume imballaggio / Embalaje volumen
	Weight / Poids / Gewicht / Gewicht / Peso / Peso
	Page / Page / Seite / Pagina / Pagina / Página
	Stackable / Empilable / Stapelbar / Stapelbaar / Impilabile / Apilables
	Extension table / Table extensible / Ausziehbarer Tisch Verlengbare tafel / Tavolo allungabile / Mesa extensible
	Wheels / Roues / Räder / Wielen / Ruote / Ruedas
	Lazy Suzan / Lazy Suzan / Lazy Suzan Lazy Suzan / Lazy Suzan / Bandeja giratoria
	Recliner / Réglable / Einstellbar / Verstelbaar / Regolabile / Adjustable
	Foldable / Pliable / Faltbar / Opvouwbaar / Pieghevole / Plegable
	EP = Electropolished / Electropolissage / Elektropoliert Geëlektropolijst / Finitura elettrolitica / Electropulida
	Colors / Couleurs / Farben Kleuren / Colori / Colores see p. 302-306

MATERIALS

YOU WANT TO FIND OUT MORE ? Not just about size and specification but also about the beautiful materials these Royal Botania pieces are made of? You will probably find the answers to your questions here, if not, your Royal Botania dealer will be happy to help you. **VOUS VOULEZ EN SAVOIR PLUS?** Pas seulement sur les dimensions et quelques spécificités mais aussi sur la qualité des matériaux des produits Royal Botania? Vous trouverez ces réponses à vos questions ici, sinon votre revendeur Royal Botania sera ravi de vous aider. **MÖCHTEN SIE MEHR** über die Maße, Ausführungen und Qualität, der von Royal Botania verwendeten Materialien erfahren? Die ersten Antworten finden Sie auf den folgenden Seiten. Für weitere Fragen steht Ihnen Ihr Royal Botania Händler jederzeit zur Verfügung. **U WIL MEER TE WETEN** **TE KOMEN** niet alleen betreffende de afmetingen en specificaties, maar tevens betreffende de prachtige materialen waaruit deze Royal Botania meubelen vervaardigd zijn? Waarschijnlijk vindt U hier de antwoorden op uw vragen, en zoniet zal uw Royal Botania dealer U graag voorthelpen. **VOLETE SAPERNE DI PIÙ** circa i bellissimi materiali che Royal Botania usa per creare questi prodotti? Probabilmente qui troverete le risposte alle Vostre domande, altrimenti il Vostro rivenditore Royal Botania sarà lieto di aiutarVi. **QUIERE SABER MÁS NO SOLAMENTE** sobre las medidas y las especificaciones, pero también sobre las espléndidas materiales de los muebles Royal Botania? Es muy probable que encuentre aquí respuestas a sus preguntas, y sino, su distribuidor le ayudará con mucho gusto.



Royal Botania

outdoor luxury

FOLD

							0,72 m ³ 33 Kg 8-15
							0,51 m ³ 24,3 Kg 8-10, 14, 15
							0,65 m ³ 29,7 Kg 8-10, 14, 15
							0,67 m ³ 29,6 Kg 8-10, 14, 15
							0,67 m ³ 29,6 Kg 8-10, 14, 15
							0,29 m ³ 19 Kg 8-10, 14, 15
							0,11 m ³ 14,5 Kg 13
							0,14 m ³ 4,0 Kg -

FOLD

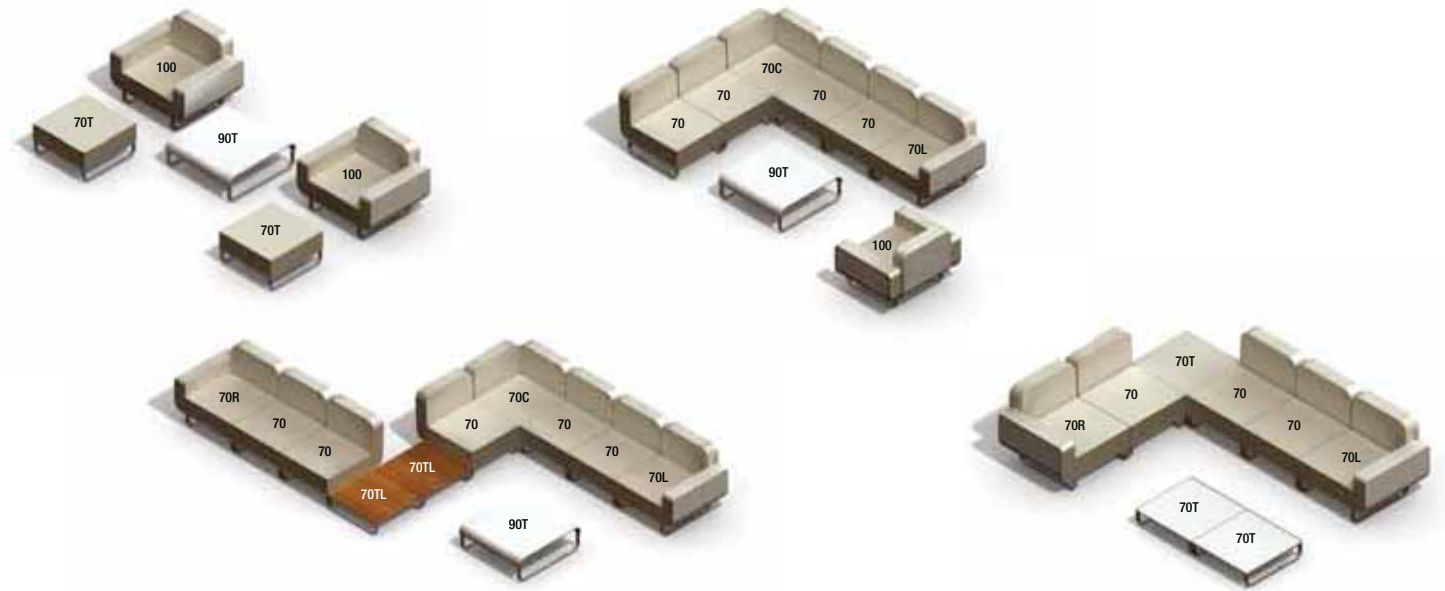

ZIDIZ

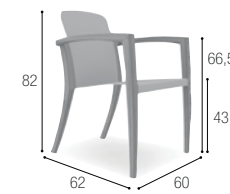

ALU WU W TK



ZDZ 55 WU
PIL ZDZ 55 ...

0,35 m³
8,2 Kg
18-23

ZIDIZ

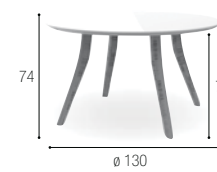

CRN WU W TK



ZDZ 130 CRNWU

GL WU W TK



ZDZ 130 GWU

0,68 m³
C: 41,5 Kg
G: 48,5 Kg
18-21

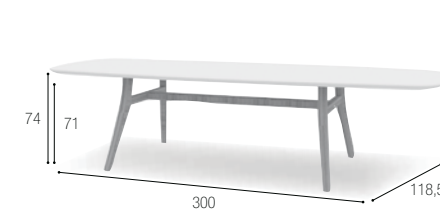

ZDZ 300 CRNWU









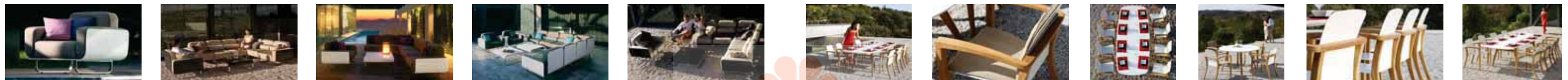

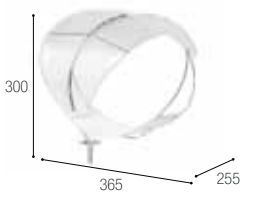

ZDZ 300 GWU

2,50 m³
C: 92,5 Kg
G: 115 Kg
22, 23

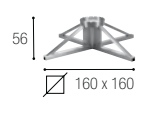
WINTER COVERS PLEASE SEE PAGE 310

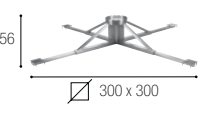

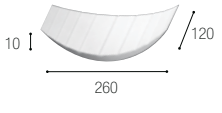







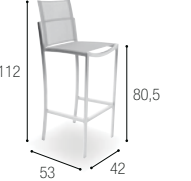



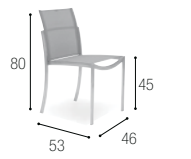

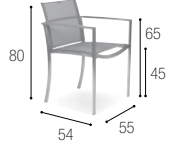

WAVE



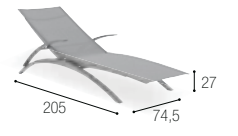



 300 365 255	 WV EPWU (*)	 WV EPCAU (*)	 WV EPZU (*)	 WV EPTQU (*)	3,85 m ² 238 Kg 26-29	
 56 160 x 160	 WWT	<ul style="list-style-type: none"> - Base for embedding in concrete - Base pour incrustation dans le béton - Basis für Einbettung in Beton 		<ul style="list-style-type: none"> - Basis voor inbouw in beton - Base per fissaggio nel cemento - Base para construcción con cemento 		2,28 m ² 183 Kg
 56 300 x 300	 WVG	<ul style="list-style-type: none"> - Base for embedding in sand - Base pour incrustation dans le sable - Basis für die Einbettung in Sand 		<ul style="list-style-type: none"> - Basis voor inbouw in zandbodem - Base per fissaggio nella sabbia - Base para enterrar 		2,28 m ² 225 Kg
 10 260 120	 PIL WV ...	<ul style="list-style-type: none"> - Storage bag and head cushion included. - Sac de rangement et appui-tête compris. - Tragetasche und Kopfstützen inklusive. 		<ul style="list-style-type: none"> - Opberghoes en hoofdkussen inbegrepen. - Borsa per riporre e cuscino poggiatesta inclusi. - Bolso para guardar y cabezal incluidos 		0,47 m ² 35 Kg 26, 28, 29

WAVE STANDARD IN EP FINISH

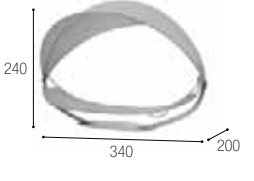
O-ZON



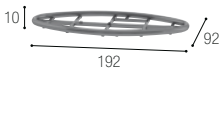







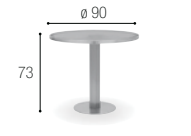

 112 53 42 80,5	 OZN 43 TWU OZN 43 TEPWU (*)	 OZN 43 TCAU OZN 43 TEPCAU (*)	 OZN 43 TZU OZN 43 TEPZU (*)	 OZN 43 TORU OZN 43 TEPORU (*)	0,26 m ² 8,1 Kg 40, 41, 44, 45
 80 53 46 45	 OZN 47 TWU OZN 47 TEPWU (*)	 OZN 47 TCAU OZN 47 TEPCAU (*)	 OZN 47 TZU OZN 47 TEPZU (*)	 OZN 47 TORU OZN 47 TEPORU (*)	0,26 m ² (4 pcs) 5,4 Kg 36, 37, 50, 51
 80 54 55 65 45	 OZN 55 TWU OZN 55 TEPWU (*) Optional teak armrest: OZN 55 T ARMSET	 OZN 55 TCAU OZN 55 TEPCAU (*) Optional teak armrest: OZN 55 T ARMSET	 OZN 55 TZU OZN 55 TEPZU (*) Optional teak armrest: OZN 55 T ARMSET	 OZN 55 TORU OZN 55 TEPORU (*) Optional teak armrest: OZN 55 T ARMSET	0,32 m ² (4 pcs) 7 Kg 37-39, 41-43, 46, 47
 205 74,5 27	 OZN 195 TWU OZN 195 TEPWU (*) Optional teak armrest: OZN 195 T ARMSET INCL. HEADCUSHION	 OZN 195 TCAU OZN 195 TEPCAU (*) Optional teak armrest: OZN 195 T ARMSET INCL. HEADCUSHION	 OZN 195 TZU OZN 195 TEPZU (*) Optional teak armrest: OZN 195 T ARMSET INCL. HEADCUSHION	 OZN 195 TORU OZN 195 TEPORU (*) Optional teak armrest: OZN 195 T ARMSET INCL. HEADCUSHION	0,45 m ² (2 pcs) 28 Kg 39, 44, 45, 48, 49

SURF

 240 340 200	 SRF EPWU (*)	 SRF EPCAU (*)	 SRF EPZU (*)	 SRF EPTQU (*)	3,46 m ² 104 Kg 30-33	
 10 192 92	 SRFB	<ul style="list-style-type: none"> - Base for placement on terrace incl. Wheelset for Surf base - Base pour placement sur la terrasse incl. Set de roues pour Surf base - Basis für Aufbau auf Terrasse incl. Rädersatz für Surf Basis 		<ul style="list-style-type: none"> - Basis voor plaatsing op terras incl. Wielenset voor Surf basis - Base da appoggiara sulla terrazza incl. Set ruote per Surf base - Base para ponerla en la terraza incl. Set ruedas por Surf base 		0,29 m ² + 0,01 m ² 73 Kg + 3 Kg

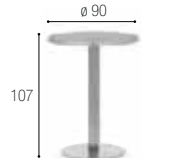
SURF STANDARD IN EP FINISH

O-ZON

 e 53 31	 OZN 50 GWU OZN 50 GEPWU (*)	 OZN 50 GCAU OZN 50 GEPCAU (*)	 OZN 50 GCLU OZN 50 GEPCLU (*)	 OZN 50 GZU OZN 50 GEPZU (*)	0,102 m ² 10,4 Kg 38, 39, 43
 e 90 73	 OZN 90 GWU OZN 90 GEPWU (*)	 OZN 90 GCAU OZN 90 GEPCAU (*)	 OZN 90 GCLU OZN 90 GEPCLU (*)	 OZN 90 GZU OZN 90 GEPZU (*)	0,086 m ² 22,2 Kg
 e 90 107	 OZN 90 HGWU OZN 90 HGEWU (*)	 OZN 90 HGCAU OZN 90 HGEPCAU (*)	 OZN 90 HGCLU OZN 90 HGEPCLU (*)	 OZN 90 HGZU OZN 90 HGEZU (*)	0,11 m ² 45 Kg 40



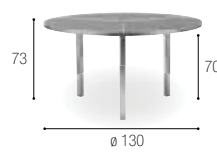

0,29 m²
31,2 Kg
42, 43

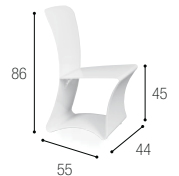

DLX 47 WU
PIL DLX 47 ...



DLX 47 RAL
PIL DLX 47 ...

0,25 m²
9,8 Kg
54, 55

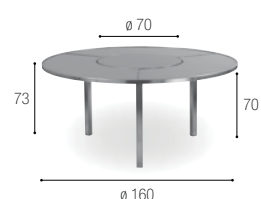

0,31 m²
78 Kg
46, 47

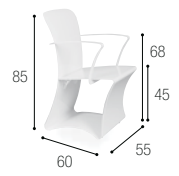

DLX 55 WU
PIL DLX 55 ...



DLX 55 RAL
PIL DLX 55 ...

0,32 m²
11,5 Kg
60-63



0,31 m²
GS: 77 Kg
WS: 56 Kg
36-38, 51

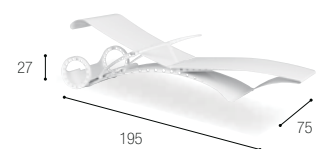

DLX 195 WU
PIL DLX 195 ...



DLX 195 RAL
PIL DLX 195 ...

0,46 m²
32 Kg
54, 56-59

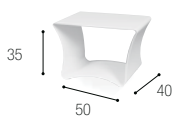

DLX 50 WU



DLX 50 RAL

0,19 m²
6,1 Kg

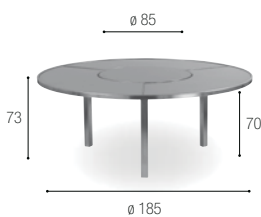

0,35 m²
100 Kg

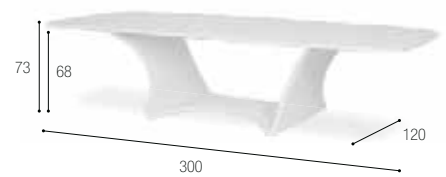

DLX 300 CRN WU

1,57 m²
115 Kg
62, 63



0,35 m²
GS: 108 Kg
WS: 76 Kg
41



DLX 130 CRN WU

0,73 m²
48 Kg
54, 55, 60, 61



OZN 130 HLS
OZN 130 HLSEP (*)
for OZN 130



OZN 160 HLS
OZN 160 HLSEP (*)
for OZN 160

0,1 m²
5-15 Kg
44

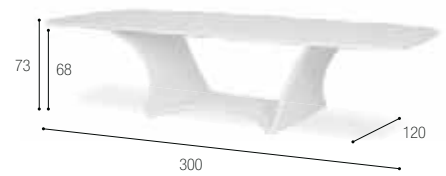

DLX 300 G WU

1,57 m²
137,5 Kg



DLX 300 G RAL



DLX 130 G WU

0,73 m²
55 Kg



DLX 130 G RAL

Frame custom made in any RAL colour + coloured glass top
ONLY AVAILABLE PER SET (minimal order > € 10.000)

High table leg set / Set de pieds pour table haute / Satz für Höhen Tisch / Set hoge tafelpoten / Set di gambe alte per tavolo / Set de patas para mesa alta

WINTER COVERS PLEASE SEE PAGE 310



NINIX

StSt W TK

84
57 52 65,5
43,5

0,28 m³
10 Kg
103, 104

NNX 55
NNX 55 EP (*)
PIL NNX 55 .. (**)

79
82,5 75 58,5
31

0,52 m³
28 Kg
106, 107

NNX 77
NNX 77 EP (*)
PIL NNX 77 .. (**)

79
82,5 140 57
31

0,97 m³
43 Kg
104

NNX 140
NNX 140 EP (*)
PIL NNX 140 .. (**)

79
82,5 205 58,5
31

1,42 m³
62 Kg
106

NNX 205
NNX 205 EP (*)
PIL NNX 205 .. (**)

43
43 184

0,34 m³
27 Kg
104

NNX 184
NNX 184 EP (*)
PIL NNX 184 .. (**)

80
80 150

0,96 m³
110 Kg
102, 103

NNX SBL
NNX SBL EP (*)

80,5
40 99,5

0,35 m³
9 Kg
83, 102

NNX TR
NNX TR EP (*)

117,4
161 61,4

0,54 m³ (2pcs)
20 Kg
86, 87

NNX 65 TWU
NNX 65 TEPWU (*)
Optional teak armrest:
NNX 65 T ARMSET
INCL. HEADCUSHION

NNX 65 TCAU
NNX 65 TEPCAU (*)
Optional teak armrest:
NNX 65 T ARMSET
INCL. HEADCUSHION

NNX 65 TZU
NNX 65 TEPZU (*)
Optional teak armrest:
NNX 65 T ARMSET
INCL. HEADCUSHION

NNX 65 TORU
NNX 65 TEPORU (*)
Optional teak armrest:
NNX 65 T ARMSET
INCL. HEADCUSHION

50
50 50

0,14 m³
22 Kg
104

NNX PL
NNX PL EP (*)

39
195 70,5

0,52 m³
28 Kg
103

NNX 195
NNX 195 EP (*)
PIL NNX 195 (**)

NINIX

StSt BAT WU

75
64,5 148 57
34

0,81 m³
27 Kg
92, 94

NNX 154T WU
NNX 154 TEPWU (*)

75
64,5 148 57
34

0,81 m³
27 Kg
92, 94

NNX 154T CAU
NNX 154 TEPCAU (*)

75
64,5 148 57
34

0,81 m³
27 Kg
92, 94

NNX 154T ZU
NNX 154 TEPZU (*)

75
64,5 148 57
34

0,81 m³
27 Kg
92, 94

NNX 154T TORU9
NNX 154 TEPORU (*)

34,5
54,5 57

0,14 m³
9 Kg
93, 95

NNX F TWU
NNX F TEPWU (*)

34,5
54,5 57

0,14 m³
9 Kg
93, 95

NNX F TCAU
NNX F TEPCAU (*)

34,5
54,5 57

0,14 m³
9 Kg
93, 95

NNX F TZU
NNX F TEPZU (*)

34,5
54,5 57

0,14 m³
9 Kg
93, 95

NNX F TORU
NNX F TEPORU (*)

98,5
76 64,5 57,5
34,5

0,5 m³
15,2 Kg
93, 95, 98, 99

NNX 60 TWU
NNX 60 TEPWU (*)
Optional teak armrest:
NNX 60 T ARMSET
INCL. HEADCUSHION

98,5
76 64,5 57,5
34,5

0,5 m³
15,2 Kg
93, 95, 98, 99

NNX 60 TCAU
NNX 60 TEPCAU (*)
Optional teak armrest:
NNX 60 T ARMSET
INCL. HEADCUSHION

98,5
76 64,5 57,5
34,5

0,5 m³
15,2 Kg
93, 95, 98, 99

NNX 60 TZU
NNX 60 TEPZU (*)
Optional teak armrest:
NNX 60 T ARMSET
INCL. HEADCUSHION

98,5
76 64,5 57,5
34,5

0,5 m³
15,2 Kg
93, 95, 98, 99

NNX 60 TORU
NNX 60 TEPORU (*)
Optional teak armrest:
NNX 60 T ARMSET
INCL. HEADCUSHION

117,4
161 61,4

0,54 m³ (2pcs)
20 Kg
86, 87

NNX 65 TWU
NNX 65 TEPWU (*)
Optional teak armrest:
NNX 65 T ARMSET
INCL. HEADCUSHION

117,4
161 61,4

0,54 m³ (2pcs)
20 Kg
86, 87

NNX 65 TCAU
NNX 65 TEPCAU (*)
Optional teak armrest:
NNX 65 T ARMSET
INCL. HEADCUSHION

117,4
161 61,4

0,54 m³ (2pcs)
20 Kg
86, 87

NNX 65 TZU
NNX 65 TEPZU (*)
Optional teak armrest:
NNX 65 T ARMSET
INCL. HEADCUSHION

117,4
161 61,4

0,54 m³ (2pcs)
20 Kg
86, 87

NNX 65 TORU
NNX 65 TEPORU (*)
Optional teak armrest:
NNX 65 T ARMSET
INCL. HEADCUSHION

38
195 71,5

0,69 m³ (2pcs)
25 Kg
89, 90

NNX 195 TWU
NNX 195 TEPWU (*)
Optional teak armrest:
NNX 195 T ARMSET
INCL. HEADCUSHION

38
195 71,5

0,69 m³ (2pcs)
25 Kg
89, 90

NNX 195 TCAU
NNX 195 TEPCAU (*)
Optional teak armrest:
NNX 195 T ARMSET
INCL. HEADCUSHION

38
195 71,5

0,69 m³ (2pcs)
25 Kg
89, 90

NNX 195 TZU
NNX 195 TEPZU (*)
Optional teak armrest:
NNX 195 T ARMSET
INCL. HEADCUSHION

38
195 71,5

0,69 m³ (2pcs)
25 Kg
89, 90

NNX 195 TORU
NNX 195 TEPORU (*)
Optional teak armrest:
NNX 195 T ARMSET
INCL. HEADCUSHION

NINIX

StSt BAT WU

87
59 52 65,5
46

0,29 m³
10 Kg
82, 85, 88, 89, 100, 101

NNX 55 TWU
NNX 55 TEPWU (*)
Optional teak armrest:
NNX 55 T ARMSET

StSt BAT CAU

87
59 52 65,5
46

0,29 m³
10 Kg
82, 85, 88, 89, 100, 101

NNX 55 TCAU
NNX 55 TEPCAU (*)
Optional teak armrest:
NNX 55 T ARMSET

StSt BAT ZU

87
59 52 65,5
46

0,29 m³
10 Kg
82, 85, 88, 89, 100, 101

NNX 55 TZU
NNX 55 TEPZU (*)
Optional teak armrest:
NNX 55 T ARMSET

StSt BAT ORU

87
59 52 65,5
46

0,29 m³
10 Kg
82, 85, 88, 89, 100, 101

NNX 55 TORU
NNX 55 TEPORU (*)
Optional teak armrest:
NNX 55 T ARMSET

43
43 184

0,35 m³
22 Kg

NNX 184 TWU
NNX 184 TEPWU

43
43 184

0,35 m³
22 Kg

NNX 184 TCAU
NNX 184 TEPCAU

43
43 184

0,35 m³
22 Kg

NNX 184 TZU
NNX 184 TEPZU

43
43 184

0,35 m³
22 Kg

NNX 184 TORU
NNX 184 TEPORU

NINIX

StSt HPL WU

73,5
66 90

0,41 m³
40 Kg
92, 94, 98, 99

NNX T LWU
NNX T LEPWU (*)

StSt HPL CAU

73,5
66 90

0,41 m³
40 Kg
92, 94, 98, 99

NNX T LCAU
NNX T LEPCAU (*)

StSt HPL ZU

73,5
66 90

0,41 m³
40 Kg
92, 94, 98, 99

NNX T LZU
NNX T LEPZU (*)

StSt CER CAU

73,5
66 90

0,41 m³
40 Kg
92, 94, 98, 99

NNX T CCAU
NNX T CEPCAU (*)

StSt CER ZU

73,5
66 90

0,41 m³
40 Kg
92, 94, 98, 99

NNX T CZU
NNX T CEPZU (*)

43
43 284

0,53 m³
33 Kg
82, 84, 85

NNX 284 TWU
NNX 284 TEPWU

43
43 284

0,53 m³
33 Kg
82, 84, 85

NNX 284 TCAU
NNX 284 TEPCAU

43
43 284

0,53 m³
33 Kg
82, 84, 85

NNX 284 TZU
NNX 284 TEPZU

43
43 284

0,53 m³
33 Kg
82, 84, 85

NNX 284 TORU
NNX 284 TEPORU

10
56 45

0,025 m³
6 Kg
98, 99

NNX 10 LWU
NNX 10 LEPWU (*)

10
56 45

0,025 m³
6 Kg
98, 99

NNX 10 LCAU
NNX 10 LEPCAU (*)

10
56 45

0,025 m³
6 Kg
98, 99

NNX 10 LZU
NNX 10 LEPZU (*)

10
56 45

0,025 m³
6 Kg
98, 99

NNX 10 CCAU
NNX 10 CEPCAU (*)

10
56 45

0,025 m³
6 Kg
98, 99

NNX 10 CZU
NNX 10 CEPZU (*)

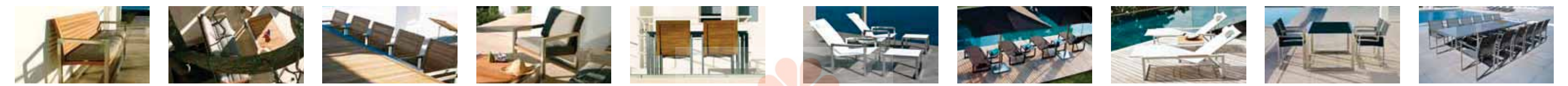

	StSt	GL WU	StSt	GL CAU	StSt	GL CLU	StSt	GL ZU	StSt	W TK	NINIX	StSt	GL WU	StSt	GL CAU	StSt	GL CLU	StSt	GL ZU		
	 NNX 50 GEPWU (*)	 NNX 50 GEPCAU (*)	 NNX 50 GEPCLU (*)	 NNX 50 GEPZU (*)	 NNX 50 EP (*)	0,13 m ³ G: 10 Kg W: 7,5 Kg 98, 99	 NNX 10 GEPWU (*)	 NNX 10 GEPCAU (*)	 NNX 10 GEPCLU (*)	 NNX 10 GEPZU (*)	0,025 m ³ 6 Kg 98, 99	 NNX 90T GEPWU (*)	 NNX 90T GEPCAU (*)	 NNX 90T GEPCLU (*)	 NNX 90T GEPZU (*)	 NNX 90 T EP (*)	NINIX				
						0,33 m ³ G: 32 Kg W: 24 Kg	 NNX 150T GEPWU (*)	 NNX 150T GEPCAU (*)	 NNX 150T GEPCLU (*)	 NNX 150T GEPZU (*)	 NNX 150 T EP (*)	0,55 m ³ G: 48 Kg W: 33 Kg 92, 94, 96, 106, 107	 NNX 360 LEPWU (*)	 NNX 360 LEPCAU (*)	 NNX 360 LEPZU (*)	 NNX 360 CEPCAU (*)	 NNX 360 CEPZU (*)	NINIX			
						0,64 m ³ G: 37 Kg W: 29 Kg 100, 101	 NNX 200 GEPWU (*)	 NNX 200 GEPCAU (*)	 NNX 200 GEPCLU (*)	 NNX 200 GEPZU (*)	 NNX 200 W EP (*)	1,43 m ³ 66 Kg 89, 104	 NNX 300 GEPWU	 NNX 300 GEPCAU	 NNX 300 GEPCLU	 NNX 300 GEPZU	 NNX 300 W EP	NINIX			
						1,02 m ³ G: 53 Kg W: 38 Kg	 NNX 270 GEPWU (*)	 NNX 270 GEPCAU (*)	 NNX 270 GEPCLU (*)	 NNX 270 GEPZU (*)		1,43 m ³ 66 Kg 89, 104	 Optional teak armrest NNX 55T ARMSET	 Optional teak armrest NNX 55T ARMSET	NINIX						
						1,02 m ³ 80 Kg 150-270	 NNX 360 GEPWU (*)	 NNX 360 GEPCAU (*)	 NNX 360 GEPCLU (*)	 NNX 360 GEPZU (*)	 NNX 360 EP (*)	1,60 m ³ 66 Kg 200-280	 Optional teak armrest NNX 77T ARMSET	 Optional teak armrest NNX 77T ARMSET	NINIX						
						1,02 m ³ 80 Kg 150-270	 NNX 280 EP (*)	NINIX					 Optional teak armrest NNX 154T ARMSET	 Optional teak armrest NNX 154T ARMSET	NINIX						
						1,92 m ³ G: 132 Kg W: 83 Kg 103 240-360	 NNX T GEPWU (*)	 NNX T GEPCAU (*)	 NNX T GEPCLU (*)	 NNX T GEPZU (*)		0,41 m ³ 40 Kg 93, 94	 NNX F TWWU	 NNX F TAZU	NINIX						
						1,92 m ³ G: 132 Kg W: 83 Kg 103 240-360	 NNX 184 TWWU	NINIX					 NNX 184 TAZU	NINIX							
						0,53 m ³ 33 Kg 82, 84, 85	 NNX 284 TWWU	NINIX					 NNX 284 TAZU	NINIX							
						0,33 m ³ G: 32 Kg W: 24 Kg		NINIX						NINIX							
						0,55 m ³ G: 48 Kg W: 33 Kg 92, 94, 96, 106, 107		NINIX						NINIX							
						0,64 m ³ G: 37 Kg W: 29 Kg 100, 101		NINIX						NINIX							
						1,02 m ³ G: 53 Kg W: 38 Kg		NINIX						NINIX							
						1,43 m ³ 66 Kg 89, 104		NINIX						NINIX							
						2,25 m ³ 143 Kg 82, 84, 85		NINIX						NINIX							
						1,02 m ³ 80 Kg 150-270		NINIX						NINIX							
						1,92 m ³ G: 132 Kg W: 83 Kg 103 240-360		NINIX						NINIX							
						0,41 m ³ 40 Kg 93, 94		NINIX						NINIX							



NINIX

CSiSt W BAT WU

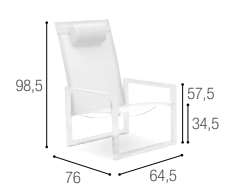

NNX 60 TWWU
Optional teak armrest:
NNX 60 T ARMSET
INCL. HEADCUSHION

CSiSt A BAT ZU



NNX 60 TAZU
Optional teak armrest:
NNX 60 T ARMSET
INCL. HEADCUSHION

0,5 m³
15,2 Kg
66-69, 74, 75

NINIX LOUNGE

StSt BAT WU

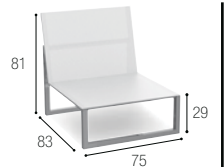

NNXL 80 TWU
NNXL 80 TEPWU
PIL NNXL 80 ..

StSt BAT CAU



NNXL 80 TCAU
NNXL 80 TEPCAU
PIL NNXL 80 ..

StSt BAT ZU



NNXL 80 TZU
NNXL 80 TEPZU
PIL NNXL 80 ..

StSt BAT ORU



NNXL 80 TORU
NNXL 80 TEPORU
PIL NNXL 80 ..

0,55 m³
21,3 Kg
76-78, 80, 81

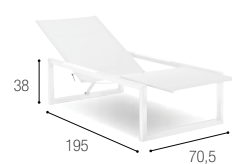

NNX 195 TWWU
Optional teak armrest
NNX 195T ARMSET
INCL. HEADCUSHION



NNX 195 TAZU
Optional teak armrest
NNX 195T ARMSET
INCL. HEADCUSHION

0,69 m³
25 Kg
66-69, 74, 75

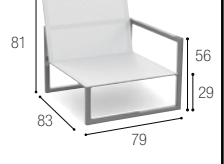

NNXL 80 LTWU
NNXL 80 LTPWU
PIL NNXL 80 ..
Optional teak armrest:
NNXL 80 LT ARMSET



NNXL 80 LTCAU
NNXL 80 LTPCAU
PIL NNXL 80 ..
Optional teak armrest:
NNXL 80 LT ARMSET



NNXL 80 LTZU
NNXL 80 LTPZU
PIL NNXL 80 ..
Optional teak armrest:
NNXL 80 LT ARMSET



NNXL 80 LTORU
NNXL 80 LTPORU
PIL NNXL 80 ..
Optional teak armrest:
NNXL 80 LT ARMSET

0,55 m³
23,4 Kg
76-78, 80, 81

NINIX

ALU W GL WU

ALU WU W TK

ALU A GL ZU

ALU A W TK



NNX 50 GWWU



NNX 50 WW



NNX 50 GAZU



NNX 50 WA

0,13 m³
G: 10 Kg
W: 7,5 Kg
74, 75

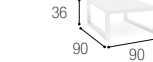

NNX 90T GWWU



NNX 90T WW



NNX 90T GAZU



NNX 90T WA

0,13 m³
G: 10 Kg
W: 7,5 Kg

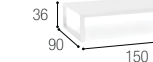

NNX 150T GWWU



NNX 150T WW



NNX 150T GAZU



NNX 150T WA

0,13 m³
G: 10 Kg
W: 7,5 Kg

NINIX

CSiSt W GL WU

CSiSt WU W TK

CSiSt A GL ZU

CSiSt A W TK

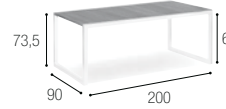

NNX 200 GWWU



NNX 200 WW



NNX 200 GAZU



NNX 200 WA

1,43 m³
66 Kg
68

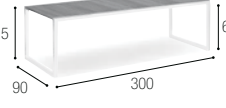

NNX 300 GWWU



NNX 300 WW



NNX 300 GAZU



NNX 300 WA

2,25 m³
143 Kg
74

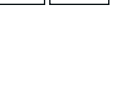

NNX 300 CAZU



NNX 300 CAZU

2,25 m³
143 Kg



NNX 270 GWWU



NNX 270 GAZU



NNX 270 GAZU



NNX 270 CAZU

1,02 m³
80 Kg
200-270



NNX 360 GWWU



NNX 360 WW



NNX 360 GAZU



NNX 360 WA



NNX 360 CAZU

1,92 m³
132 Kg
70-73
240-360

NINIX LOUNGE

StSt GL WU



NNXL 40 TGWU
NNXL 40 TEPGWU

StSt GL CLU



NNXL 40 TGCLU
NNXL 40 TEPGCLU

StSt GL ZU



NNXL 40 TGZU
NNXL 40 TEPGZU

StSt W TK



NNXL 40 TW
NNXL 40 TEPW

0,10 m³
12,8 Kg
76-78, 80, 81



NNXL 40 SGWU
NNXL 40 SEPGWU



NNXL 40 SGCLU
NNXL 40 SEPGCLU



NNXL 40 SGZU
NNXL 40 SEPGZU



NNXL 40 SW
NNXL 40 SEPW

0,19 m³
19,5 Kg
76-78, 80, 81



I X I T

I X I T

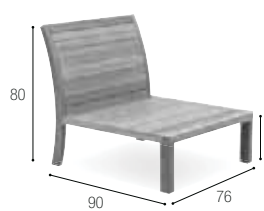

IXIT 70
PIL IXIT 70 .. (**)

0,136 m³
18 Kg
126, 127



IXIT 70L
PIL IXIT 70 .. (**)

0,195 m³
(2pcs)
21 Kg
126, 127

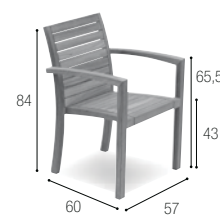

IXIT 55
PIL IXIT 55 .. (**)

0,51 m³
(4pcs)
9 Kg
124, 125



IXIT 360

1,8 m³
86 Kg
124, 125
240-360

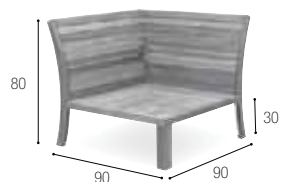

IXIT 70C
PIL IXIT 70C .. (**)

0,757 m³
25 Kg
126, 127



IXIT 77
PIL IXIT 70 .. (**)

0,195 m³
24 Kg
126, 127, 128, 129

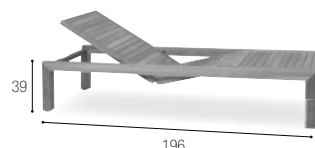

IXIT 195
PIL IXIT 195 ..

0,59 m³
32 Kg
120-123

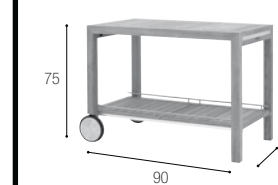

IXIT T

0,41 m³
40 Kg
130, 131



IXIT 70R
PIL IXIT 70 .. (**)

0,195 m³
(2pcs)
21 Kg
126, 127

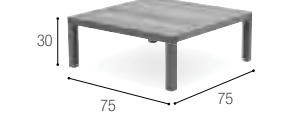

IXIT 70T
PIL IXIT 70T .. (**)

0,064 m³
12 Kg
126, 127, 128, 129



IXIT 70 CONNECT
to connect IXIT 70C with IXIT 70R/L

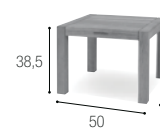

IXIT 50

0,12 m³
7 Kg
120, 121

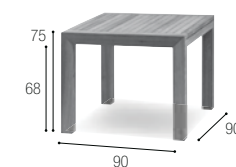

IXIT 90

0,14 m³
36 Kg



IXIT 270

1,13 m³
73 Kg
150-270

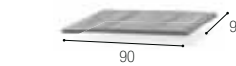

IXITEX - Extension for IXIT 90

0,05 m³
11 Kg

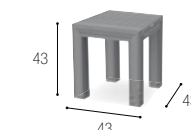

IXIT 43

0,08 m³
8,5 Kg
116-119

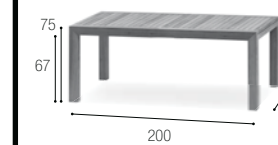

IXIT 200

0,38 m³
54 Kg
142-145



IXIT 118

0,23 m³
15,5 Kg
116, 117, 119

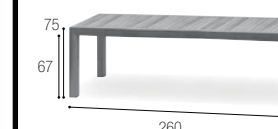

IXIT 260

0,59 m³
78 Kg
116, 117, 119

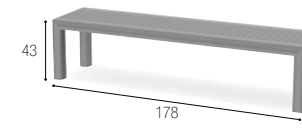

IXIT 178

0,35 m³
22 Kg
119



IXIT 320

0,72 m³
93 Kg

WINTER COVERS PLEASE SEE PAGE 310

WINTER COVERS PLEASE SEE PAGE 310



KOKOON



250 x 250



KKN 260 WU

W TK BAT WU



KKN 260 CAU

W TK BAT CAU

0,97 m³
83 Kg
136-139



257 x 257



KKNT

- Base for mounting on terrace
- Base pour montage sur terrasse
- Basis für Montage auf Terrasse

- Basis voor plaatsing op terras
- Struttura da oppoggiare sulla terrazza
- Estructura para ponila en la terraza

0,29 m³
112 Kg
136-139



233 x 233



KKNG

- X-frame embedding in ground
- Cadre pour intégrer au isol
- Struktur für einbau im Bodem

- Structuur voor plaatsing ondergronds
- Struttura da interrare
- Estructura para enterraria

0,29 m³
109 Kg



KKNC

- Curtain set
- Voilage
- Vorhang set

- Gordijnset
- Set di tende
- Juego de cortinas

0,01 m³
1,50 Kg
136-139

SUNDAY

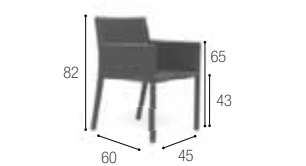

82 65 43 60 45



SUD 53 FO
PIL SUD 53 .. (**)

CX FO



SUD 53 CA
PIL SUD 53 .. (**)

CX CA



SUD 53 ZU
PIL SUD 53 .. (**)

CX ZU

0,276 m³
11,4 Kg
142-145

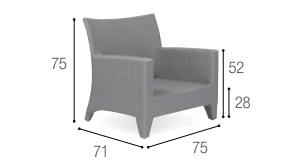

75 52 28 71 75



SUD 77 FO
PIL SUD 77 .. (**)

CX FO



SUD 77 CA
PIL SUD 77 .. (**)

CX CA



SUD 77 ZU
PIL SUD 77 .. (**)

CX ZU

0,44 m³
15 Kg
158-161

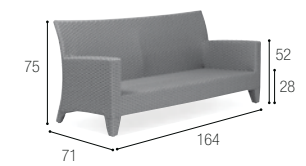

75 52 28 71 164



SUD 154 FO
PIL SUD 154 .. (**)

CX FO



SUD 154 CA
PIL SUD 154 .. (**)

CX CA



SUD 154 ZU
PIL SUD 154 .. (**)

CX ZU

0,96 m³
23 Kg
158-161

SUNDAY

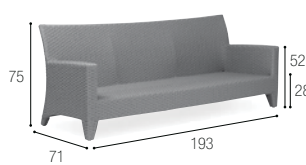

75 52 28 71 193



SUD 200 FO
PIL SUD 200 .. (**)

CX FO



SUD 200 CA
PIL SUD 200 .. (**)

CX CA



SUD 200 ZU
PIL SUD 200 .. (**)

CX ZU

1,13 m³
27 Kg



40 195 70



SUD 193 FO
PIL SUD 193 .. (**)

CX FO



SUD 193 CA
PIL SUD 193 .. (**)

CX CA



SUD 193 ZU
PIL SUD 193 .. (**)

CX ZU

0,67 m³ (2pcs)
20 Kg
147



53 195 82 33



SUD 195 FO
PIL SUD 195 .. (**)

CX FO



SUD 195 CA
PIL SUD 195 .. (**)

CX CA



SUD 195 ZU
PIL SUD 195 .. (**)

CX ZU

0,74 m³
26 Kg
157, 159-161

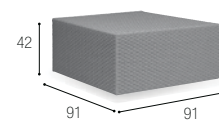

42 91 91



SUD 90 T FO

CX FO



SUD 90 T CA

CX CA

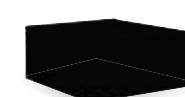

SUD 90 T ZU

CX ZU

0,38 m³
22 Kg

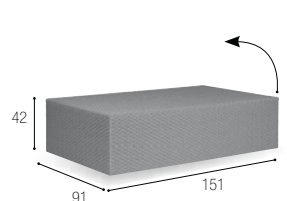

42 91 151



SUD 150 T FO

CX FO



SUD 150 T CA

CX CA



SUD 150 T ZU

CX ZU

0,64 m³
32 Kg
170

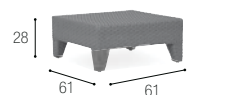

28 61 61



SUD 60 TFO
PIL SUD 60 .. (**)

CX FO



SUD 60 TCA
PIL SUD 60 .. (**)

CX CA



SUD 60 TZU
PIL SUD 60 .. (**)

CX ZU

0,12 m³
8 Kg
158-161

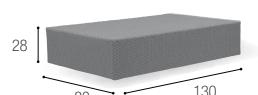

28 80 130



SUD 130 TFO

CX FO



SUD 130 TCA

CX CA



SUD 130 TZU

CX ZU

0,44 m³
26 Kg

WINTER COVERS PLEASE SEE PAGE 44



CX FO

CX CA

CX ZU

CX FO

CX CA

CX ZU

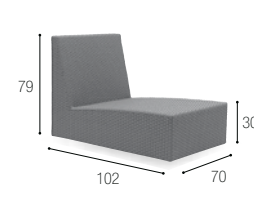

SUDL 70 FO
PIL SUDL 70 ..



SUDL CONNECT 1
to connect SUDL 70 with
SUDL 70 C



SUDL 70 CA
PIL SUDL 70 ..



SUDL 70 ZU
PIL SUDL 70 ..

0,96 m³
(2pcs)
15 Kg
151-155

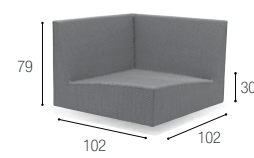

SUDL 70 CFO
PIL SUDL 70 C L/R ..



SUDL 70 CCA
PIL SUDL 70 C L/R ..



SUDL 70 CZU
PIL SUDL 70 C L/R ..

1,22 m³
(2pcs)
25 Kg
151-155

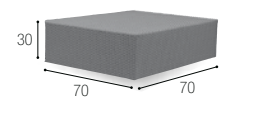

SUDL 70 FFO
PIL SUDL 70 F ..

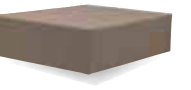

SUDL 70 FCA
PIL SUDL 70 F ..



SUDL 70 FZU
PIL SUDL 70 F ..

0,18 m³
9 Kg
148, 154

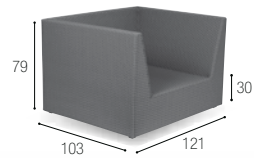

SUDL 120 FO
PIL SUDL 120 ..



SUDL 120 CA
PIL SUDL 120 ..

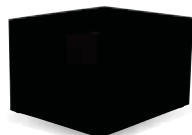

SUDL 120 ZU
PIL SUDL 120 ..

1,24 m³
31 Kg
148, 149

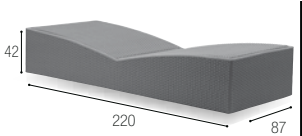

SUDL 220 FO
PIL SUDL 220 ..
(incl. head cushion) (**)



SUDL 220 CA
PIL SUDL 220 ..
(incl. head cushion) (**)



SUDL 220 ZU
PIL SUDL 220 ..
(incl. head cushion) (**)

0,88 m³
40 Kg
152, 155

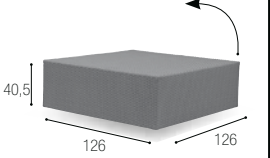

SUDL 125 FO



SUDL 125 CA



SUDL 125 ZU

0,69 m³
48 Kg

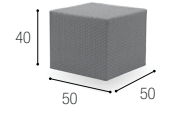

SUDL 50 FO
PIL SUDL 50 .. (**)



SUDL 50 CA
PIL SUDL 50 .. (**)



SUDL 50 ZU
PIL SUDL 50 .. (**)

0,12 m³
6,5 Kg
153, 155



SUD SB FO



SUD SB CA



SUD SB ZU

1,6 m³
78 Kg
146

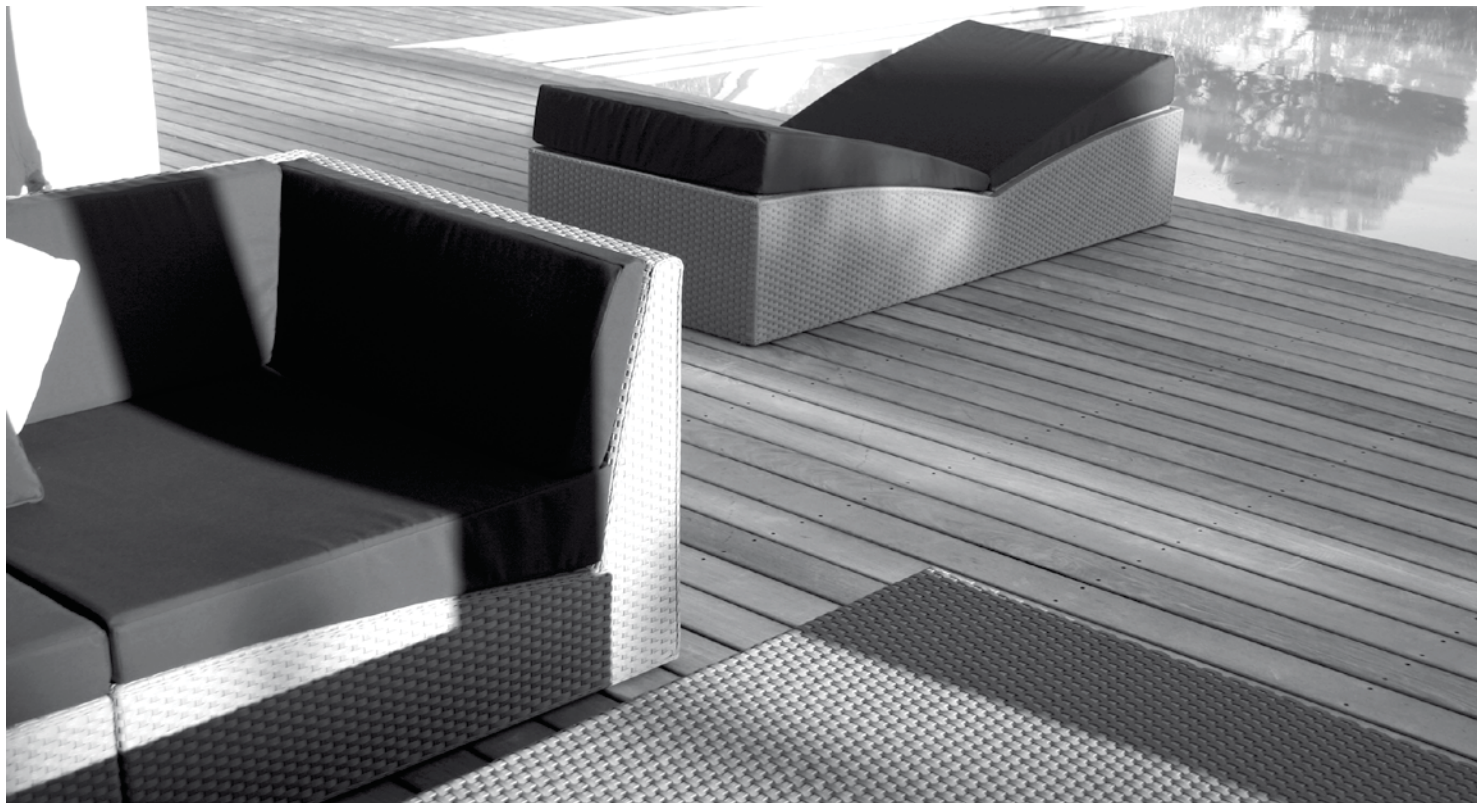

WINTER COVERS PLEASE SEE PAGE 310

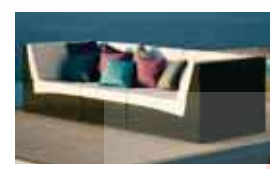

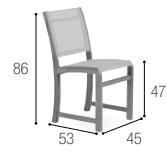

MXT47TEPEU (*)



MXT47TEPBRU (*)



MXT47TEPZU (*)

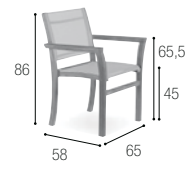

MXT55TEPEU (*)



MXT55TEPBRU (*)



MXT55TEPZU (*)

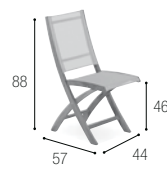

MXT47FEPEU (*)



MXT47FEPBRU (*)



MXT47FEPZU (*)

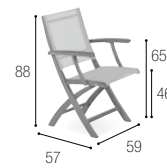

MXT55FEPEU (*)



MXT55FEPBRU (*)



MXT55FEPZU (*)

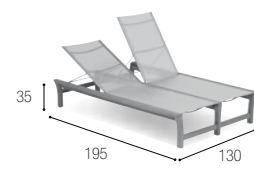
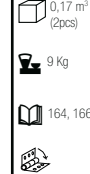

MXT295T2EPEU (*)



MXT295T2EBRU (*)



MXT295T2EPZU (*)



NEW ENGLAND

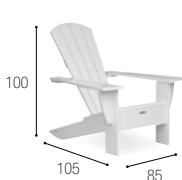

NEH 85 W
Seat: PIL NE 85 .. (**)
Head: PIL NEH (**)



NEH 85 G
Seat: PIL NE 85 .. (**)
Head: PIL NEH (**)



NEH 85 R
Seat: PIL NE 85 .. (**)
Head: PIL NEH (**)

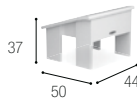
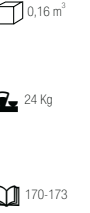

NE 50 W

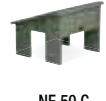

NE 50 G



NE 50 R

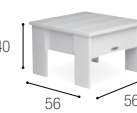
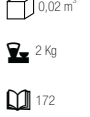

NE 56 W



NE 56 G



NE 56 R

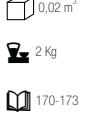

NEW W



NEW G



NEW R

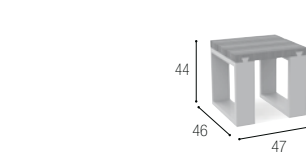
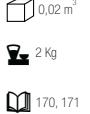

VGR 50 WW



VGR 50 WMH

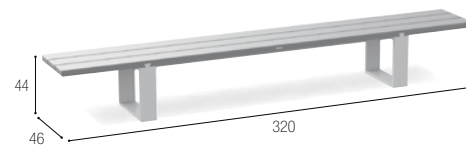
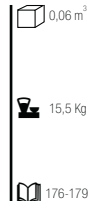

VGR 318 WW



VGR 318 WMH

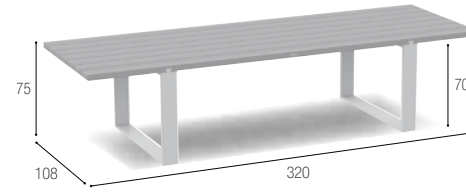

VGR 320 WW



VGR 320 WMH



FOR PRICES REFER TO OUTDOOR LIGHTING PRICE LIST

DOME MOVE

ALU WU GL ALU ZU GL

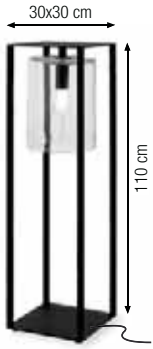

0,15
13,8 kg
37

CE IP43 230 ~ 1 X E27 230V / MAX 60W

CLUB

StSt W TK PVC



0,91
22,2 kg
109

CE IP55 230 ~ 1 X TC DSE 7-11W E27 230 V - 50 Hz

60T

StSt PE GR

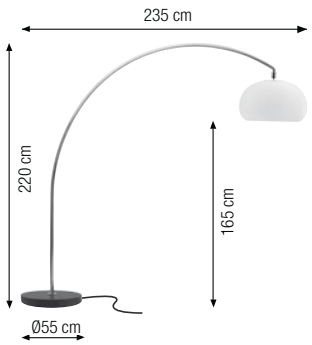

0,49
79 kg
11

CE IP43 230 ~ 1 X E27 230V / MAX 60W

LAMPALAIR

StSt PP GR

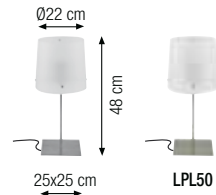

0,02
3,4

CE IP55 230 ~ 1 X G9 - 25W



0,06
30,4 kg

CE IP55 230 ~ 1 X TC DSE 7-11W E27 230 V - 50 Hz

DOME SMALL

ALU WU GL ALU ZU GL

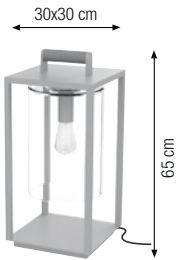

0,07m³
13 kg
37

CE IP43 230 ~ 1 X E27 230V / MAX 60W

3D

ALU WU TEX

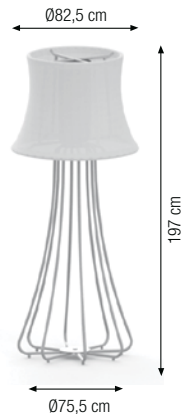

1,25m³
16 kg
109

CE IP55 230 ~ 1 X TC DSE 7-11W E27 230 V - 50 Hz

SEE OUR COMPLETE OUTDOOR LIGHTING COLLECTION ON WWW.ROYALBOTANIA.COM
OR ASK YOUR DEALER FOR OUR LIGHTING CATALOGUE

Royal Botania

red label collection

ALURA

	ALU W	BAT WU	ALU S	BAT PG	ALU A	BAT ZU	
	<p>ALR 43 TWWU Optional teak armrest: ALR 43 T ARMSET</p>	<p>ALR 43 TSPG Optional teak armrest: ALR 43 T ARMSET</p>	<p>ALR 43 TAZU Optional teak armrest: ALR 43 T ARMSET</p>	<p>0,5 m³ (4 pcs)</p> <p>9,8 Kg</p> <p>187-189</p>			
	<p>ALR 47 TWWU</p>	<p>ALR 47 TSPG</p>	<p>ALR 47 TAZU</p>	<p>0,34 m³ (4 pcs)</p> <p>6,4 Kg</p> <p>194-196</p>			
	<p>ALR 55 TWWU Optional teak armrest: ALR 55 T ARMSET</p>	<p>ALR 55 TSPG Optional teak armrest: ALR 55 T ARMSET</p>	<p>ALR 55 TAZU Optional teak armrest: ALR 55 T ARMSET</p>	<p>0,38 m³ (4 pcs)</p> <p>9,9 Kg</p> <p>190-193</p>			
	<p>ALR 77 TWWU Optional teak armrest: ALR 77 T ARMSET</p>	<p>ALR 77 TSPG Optional teak armrest: ALR 77 T ARMSET</p>	<p>ALR 77 TAZU Optional teak armrest: ALR 77 T ARMSET</p>	<p>0,44 m³ (4 pcs)</p> <p>9,5 Kg</p> <p>184-186</p>			
	<p>ALR FR TWWU</p>	<p>ALR FR TSPG</p>	<p>ALR FR TAZU</p>	<p>0,15 m³ (4 pcs)</p> <p>3,1 Kg</p>			
	<p>ALR 195 TWWU Optional teak armrest: ALR 195 T ARMSET</p>	<p>ALR 195 TSPG Optional teak armrest: ALR 195 T ARMSET</p>	<p>ALR 195 TAZU Optional teak armrest: ALR 195 T ARMSET</p>	<p>0,96 m³ (4 pcs)</p> <p>22,7 Kg</p> <p>197-199</p>			
	<p>ALR 195 TPWWU Optional teak armrest: ALR 195 T ARMSET</p>	<p>ALR 195 TPSPG Optional teak armrest: ALR 195 T ARMSET</p>	<p>ALR 195 TPAZU Optional teak armrest: ALR 195 T ARMSET</p>	<p>0,96 m³ (4 pcs)</p> <p>15,2 Kg</p>			



TABOELA

TABOELA

StSt GL WU

StSt GL CLU

StSt GL ZU

StSt W TK

StSt HPL WU

StSt HPL CAU

StSt HPL ZU

StSt CER CAU

StSt CER ZU

				0,11 m ² 11,3 Kg 197						0,11 m ² 11,3 Kg 197
				0,10 m ² G: 26 Kg W: 16 Kg 186						0,10 m ² 32 Kg 186
				0,1 m ² G: 32 Kg W: 22 Kg 228, 229						0,1 m ² G: 32 Kg W: 22 Kg 228, 229
				0,10 m ² G: 32 Kg W: 22 Kg						0,10 m ² 32 Kg
				0,15 m ² 44 Kg						0,10 m ² 44 Kg
				0,24 m ² G: 62 Kg W: 40 Kg						0,24 m ² 62 Kg
				0,24 m ² 62 Kg						0,24 m ² 62 Kg
				0,35 m ² 84 Kg						0,35 m ² 84 Kg 33,35
				0,35 m ² 124 Kg 190, 191, 193						0,35 m ² 124 Kg 190, 191, 193
				0,24 m ² G: 115 Kg W: 73 Kg 226, 227 220-340						0,24 m ² G: 115 Kg W: 73 Kg 226, 227 220-340
				0,10 m ² G: 36 Kg W: 26 Kg						0,10 m ² 32 Kg
				0,35 m ² 84 Kg 187, 188						0,35 m ² 84 Kg 187, 188



TABOELA

ALU W GL WU

ALU S GL PG

ALU A GL ZU

ALU A CER ZU

ALU W W TK

ALU S W TK

ALU A W TK

ALU W HPL WU

ALU A HPL ZU

					0,11 m ² 11,3 Kg 197
					0,10 m ² 26 Kg 186
					0,10 m ² 32 Kg -
					0,10 m ² 44 Kg -
					0,24 m ² G: 62 Kg W: 40 Kg -
					0,24 m ² 62 Kg -
					0,10 m ² 36 Kg -

						0,11 m ² 11,3 Kg 197
						0,10 m ² 26 Kg 186
						0,10 m ² 32 Kg -
						0,10 m ² 44 Kg -
						0,24 m ² 62 Kg -
						0,24 m ² 62 Kg -
						0,10 m ² 36 Kg -

TABOELA

CSiSt W GL WU

CSiSt S GL PG

CSiSt A GL ZU

CSiSt A CER ZU

CSiSt W W TK

CSiSt S W TK

CSiSt A W TK

CSiSt W HPL WU

CSiSt A HPL ZU

					0,35 m ² 84 Kg -
					0,35 m ² 124 Kg 190, 191, 193
					0,24 m ² G: 115 Kg W: 73 Kg 226, 227 220-340

						0,35 m ² 84 Kg 33,35
						0,35 m ² 124 Kg 190, 191, 193
						0,24 m ² G: 115 Kg W: 73 Kg 226, 227 220-340



SEXION

SX 140 LSSWU SX 140 LSSEPWU (*)					SX 140 LSSCAU SX 140 LSSEPCAU (*)					SX 140 LSSZU SX 140 LSSEPZU (*)					SX 140 CSSCAU SX 140 CSSEPCAU (*)					SX 140 CSSZU SX 140 CSSEPZU (*)				

SX 140 LZUWU					SX 140 LZUCAU					SX 140 LZU					SX 140 CZUCAU					SX 140 CZU				

SX 205 LSSWU SX 205 LSSEPWU (*)					SX 205 LSSCAU SX 205 LSSEPCAU (*)					SX 205 LSSZU SX 205 LSSEPZU (*)					SX 205 CSSCAU SX 205 CSSEPCAU (*)					SX 205 CSSZU SX 205 CSSEPZU (*)				

SX 205 LZUWU					SX 205 LZUCAU					SX 205 LZU					SX 205 CZUCAU					SX 205 CZU				

SX 275 LSSWU SX 275 LSSEPWU (*)					SX 275 LSSCAU SX 275 LSSEPCAU (*)					SX 275 LSSZU SX 275 LSSEPZU (*)					SX 275 CSSCAU SX 275 CSSEPCAU (*)					SX 275 CSSZU SX 275 CSSEPZU (*)				

SX 275 LZUWU					SX 275 LZUCAU					SX 275 LZU					SX 275 CZUCAU					SX 275 CZU				

SEXION

SX 140 LWU					SX 140 LWUCAU					SX 140 LWUZU					SX 140 CWUCAU					SX 140 CWUZU				

SX 140 LSUWU					SX 140 LSUCAU					SX 140 LSUZU					SX 140 CSUCAU					SX 140 CSUZU				

SX 205 LWU					SX 205 LWUCAU					SX 205 LWUZU					SX 205 CWUCAU					SX 205 CWUZU				

SX 205 LSUWU					SX 205 LSUCAU					SX 205 LSUZU					SX 205 CSUCAU					SX 205 CSUZU				

SX 275 LWU					SX 275 LWUCAU					SX 275 LWUZU					SX 275 CWUCAU					SX 275 CWUZU				

SX 275 LSUWU					SX 275 LSUCAU					SX 275 LSUZU					SX 275 CSUCAU					SX 275 CSUZU				

WINTER COVERS PLEASE SEE PAGE 310

WINTER COVERS PLEASE SEE PAGE 310

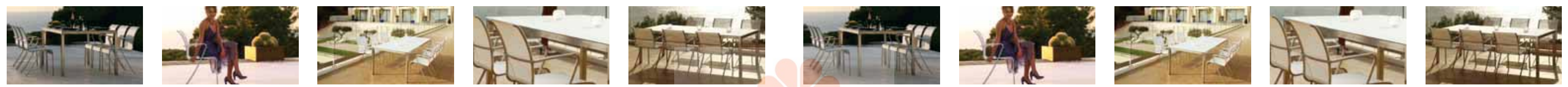

LITTLE - L

ALU WUL BAT WU

ALU CLU BAT CLU

StSt BAT WU

StSt BAT CAU

StSt BAT ZU

StSt BAT ORU

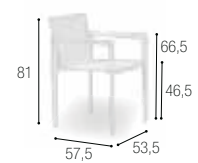

LTL 55 TWUL



LTL 55 FWUL

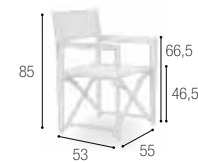

LTL 55 TCLU



LTL 55 FCLU

0,31 m²
6,9 Kg
202, 204-206

0,1 m²
6,1 Kg
207-209

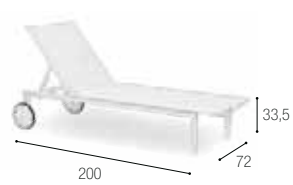

LTL 195 TWUL
Optional Head Cushion:
PIL LTL HGRWUL



LTL 195 TCLU
Optional Head Cushion:
PIL LTL HGRCLU

0,72 m²
33 Kg
202-205

LITTLE - L

ALU WUL GL WU

ALU CLU GL CLU

ALU WUL W TK

ALU CLU W TK

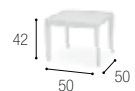

LTL 50 GWUL



LTL 50 GCLU



LTL 50 WWUL



LTL 50 WCLU

0,15 m²
8 Kg
202-205

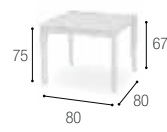

LTL 80 GWUL



LTL 80 GCLU



LTL 80 WWUL



LTL 80 WCLU

0,12 m²
29 Kg

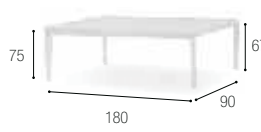

LTL 180 GWUL



LTL 180 GCLU



LTL 180 WWUL



LTL 180 WCLU

0,30 m²
61 Kg
208, 209

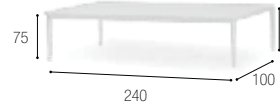

LTL 240 GWUL



LTL 240 GCLU



LTL 240 WWUL



LTL 240 WCLU

0,43 m²
86 Kg
202-205

WINTER COVERS PLEASE SEE PAGE 310

QT

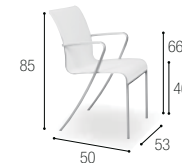

QT 55 TWU
QT 55 TEPWU (*)
Optional teak armrest:
QT 55 T ARMSET



QT 55 TCAU
QT 55 TEPCAU (*)
Optional teak armrest:
QT 55 T ARMSET



QT 55 TZU
QT 55 TEPZU (*)
Optional teak armrest:
QT 55 T ARMSET



QT 55 TORU
QT 55 TEPORU (*)
Optional teak armrest:
QT 55 T ARMSET

0,31 m²
(4 pcs)
8,6 Kg
222-233

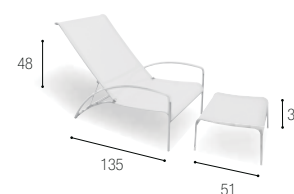

QT 195 TWU
QT 195 TEPWU (*)
Incl. Head Cushion



QT 195 TCAU
QT 195 TEPCAU (*)
Incl. Head Cushion



QT 195 TZU
QT 195 TEPZU (*)
Incl. Head Cushion



QT 195 TORU
QT 195 TEPORU (*)
Incl. Head Cushion

0,44 m² (2 pcs)
18,8 Kg
224, 230-233



QT 195 T2WU
QT 195 T2EPWU (*)
Incl. Head Cushion



QT 195 T2CAU
QT 195 T2EPCAU (*)
Incl. Head Cushion



QT 195 T2ZU
QT 195 T2EPZU (*)
Incl. Head Cushion



QT 195 T2ORU
QT 195 T2EPORU (*)
Incl. Head Cushion

0,75 m² (2 pcs)
22,2 Kg
230, 231

QT



QT 50 GWU
QT 50 GEPWU (*)



QT 50 GCLU
QT 50 GEPCLU (*)



QT 50 GZU
QT 50 GEPZU (*)

0,1 m²
8 Kg
224, 230, 231



WINTER COVERS PLEASE SEE PAGE 310



XQI

W TK BAT WU

W TK BAT BRU

W TK BAT ZU

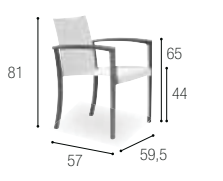

XQI 55 TEPWU (*)



XQI 55 TEPBRU (*)



XQI 55 TEPZU (*)

0,37 m³
(2 pcs)
7,6 Kg
236-239

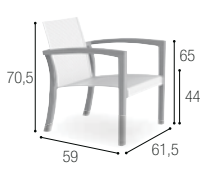

XQI 77 TEPWU (*)



XQI 77 TEPBRU (*)



XQI 77 TEPZU (*)

0,34 m³
(2 pcs)
7,3 Kg
240,241

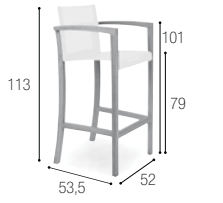

XQI 43 TEPWU (*)



XQI 43 TEPBRU (*)



XQI 43 TEPZU (*)

0,31 m³
8,8 Kg
242,243

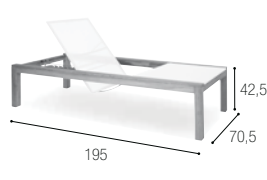

XQI 195 TEPWU (*)



XQI 195 TEPBRU (*)



XQI 195 TEPZU (*)

0,37 m³
(2 pcs)
32,8 Kg
244,245

XQI STEELWORK STANDARD IN EP FINISH

XQI

W TK

W TK

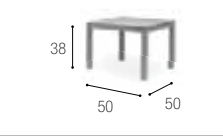

XQI 50 W

0,06 m³
5 Kg

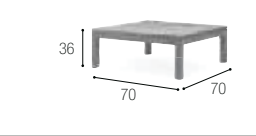

XQI 70T W

0,16 m³
10,3 Kg
240,241

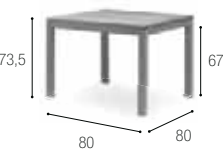

XQI 80 W

0,10 m³
15,2 Kg

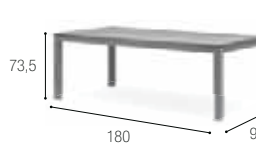

XQI 180 W

0,16 m³
26,6 Kg
236,237

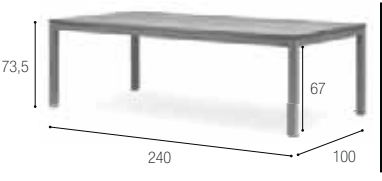

XQI 240 W

0,23 m³
37,6 Kg

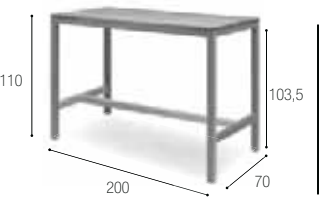

XQI 200H W

1,54 m³
34,7 Kg
242,243

BEACHER

W TK TEX WU

W TK TEX EU

W TK TEX GU

W TK TEX BU

W TK TEX TU

W TK TEX GRU

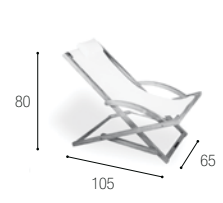

BEA 65 WU
PIL BEA 65 WU .. (**)



BEA 65 EU
PIL BEA 65 EU .. (**)



BEA 65 GU
PIL BEA 65 GU .. (**)



BEA 65 BU
PIL BEA 65 BU .. (**)



BEA 65 TU
PIL BEA 65 TU .. (**)



BEA 65 GRU
PIL BEA 65 GRU .. (**)

0,10 m³
6 Kg
57

W TK TEX MU

W TK TEX CAU

W TK TEX FOU

W TK TEX ZU

W TK BAT BU

W TK BAT TEU



BEA 65 MU
PIL BEA 65 MU .. (**)



BEA 65 CAU
PIL BEA 65 CAU .. (**)



BEA 65 FOU
PIL BEA 65 FOU .. (**)



BEA 65 ZU
PIL BEA 65 ZU .. (**)



BEA 65 TWU
PIL BEA 65 TWU .. (**)



BEA 65 TEU
PIL BEA 65 TEU .. (**)

0,10 m³
6 Kg
247

W TK BAT CAU

W TK BAT BRU

W TK BAT ZU

W TK BAT ORU

W TK BAT TQU

W TK BAT SU



BEA 65 TCAU
PIL BEA 65 TCAU .. (**)



BEA 65 TBRU
PIL BEA 65 TBRU .. (**)



BEA 65 TZU
PIL BEA 65 TZU .. (**)



BEA 65 TORU
PIL BEA 65 TORU .. (**)



BEA 65 TTQU
PIL BEA 65 TTQU .. (**)



BEA 65 TSU
PIL BEA 65 TSU .. (**)

0,10 m³
6 Kg
247

WINTER COVERS PLEASE SEE PAGE 310

W TK TEX WU

W TK TEX EU

W TK TEX GU

W TK TEX BU

W TK TEX TU

W TK TEX GRU

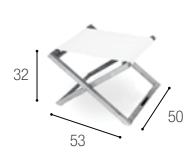

BEA F 65 WU



BEA F 65 EU



BEA F 65 GU



BEA F 65 BU



BEA F 65 TU



BEA F 65 GRU

0,03 m³
2,2 Kg
247

W TK TEX MU

W TK TEX CAU

W TK TEX FOU

W TK TEX ZU

W TK BAT WU

W TK BAT EU



BEA F 65 MU



BEA F 65 CAU



BEA F 65 FOU



BEA F 65 ZU



BEA F 65 TWU



BEA F 65 TEU

0,03 m³
2,2 Kg
247

W TK BAT CAU

W TK BAT BRU

W TK BAT ZU

W TK BAT ORU

W TK BAT TQU

W TK BAT SU



BEA F 65 TCAU



BEA F 65 TBRU



BEA F 65 TZU



BEA F 65 TORU



BEA F 65 TTQU



BEA F 65 TSU

0,03 m³
2,2 Kg
57

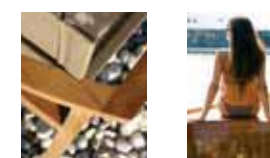
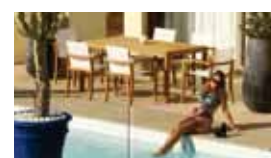

MAINTENANCE

TEAK / TECK / TEAKHOLZ / TEAK / TEAK / TECA

STAINLESS STEEL / ACIER INOXYDABLE / EDELSTAHL
ROESTVAST STAAL / ACCIAIO INOSSIDABILE / ACERO INOXIDABLE

TEAK CLEANER

- Ref: TEAC – 500ml**
- POWERFUL CLEANER: for removal of all stains and dirt on teakwood.
 - NETTOYANT PUISSANT: pour le traitement des taches et toutes les salissures sur le teck.
 - KRAFTVOLLER REINIGER: zur Beseitigung von Flecken und allen Verunreinigungen auf Teakholz.
 - KRACHTIGE REINIGER: voor de behandeling van vlekken en alle soorten bevulling op teakhout.
 - POTENTE LIMPIADOR: para eliminar manchas y suciedad en madera de teca.
 - POTENTE DETERGENTE: per la rimozione di tutte le macchie e della sporcizia dal teak.



TEAK SEALER

- Ref: TEAS – 500 ml**
- Long-term protection against weathering and graying.
 - Protection contre décoloration et grisaillement.
 - Beinhaltet Teakfarbe, schützt langanhaltend gegen silbergraue Patina.
 - Langdurige bescherming tegen vertering en vergrijzen.
 - Protección de larga duración contra el desgaste y la pérdida de color.
 - Protezione a lungo termine dagli agenti atmosferici e dall'ingrigimento.



STAINLESS STEEL CLEANER

- Ref: SSC – 500ml**
- Stainless steel cleaner
 - Nettoyant pour acier inoxydable
 - Edelstahlreiniger
 - Inox reinigingsmiddel
 - Limpiador de acero inoxidable
 - Detergente per acciaio inox



STAINLESS STEEL HEAVY DUTY CLEANER

- Ref: SSHC – 500ml**
- Stainless steel polish
 - Polish inox
 - Edelhöhlpolitur
 - Roestvrij staal polish
 - Pulidor de acero inoxidable
 - Lucidante per acciaio inossidabile



TEAK RENOVATOR

- Ref: TEAR – 500ml**
- Restoration of discoloured teak
 - Renover le teck décoloré
 - Restoriert graues Teakholz
 - Herneuewen van vergrijsd teak
 - Renovador de la teca desgastada
 - Rinnovo il teak grigio



TEAK PROTECTOR

- Ref: TEAPR – 500ml**
- TEAK PROTECTOR: Protects against moisture and dirt
 - PROTECTEUR POUR TECK: Protège contre l'humidité et les salissures
 - TEAKSCHUTZMITTEL: Schützt gegen Wasser und Verschmutzung
 - TEAK BESCHERMER: Voorkomt vocht –en vuilindringing
 - TRATTAMENTO DI PROTEZIONE PER TEAK: Protegge dall'umidità e dalla sporcizia
 - PROTETTORE PER TEAK: Protegge da umidità e sporco



STAINLESS STEEL PROTECTOR

- Ref: SSP – 500 ml**
- Stainless steel protector / renewer: Cleans & protects
 - Protecteur / renouveur inox: Nettoie & protège
 - Edelhöhlenschutz: Reinigt, schützt & erneuert
 - Roestvrij staal beschermer / vernieuwer: Reinigt & beschermt
 - Agente protettivo / rinnovatore acciaio inox: Pulisce & protegge
 - Protector / renovador de acero inoxidable: Limpia & protege



STAINLESS STEEL MAINTENANCE SET

- Ref: SSM**
- Set of cleaning product for stainless steel and demineralized rinsing agent
 - Ensemble d'un produit de nettoyage pour acier inoxydable et un produit rinçage déminéralisé
 - Set aus demineralisiertem Spül- und Reinigungsmittel für Edelhöhl
 - Set van reinigingsmiddel voor inox en gedemineriseerd spoelmiddel
 - Serie de productos de limpieza para acero inoxidable y agentes limpiadores desmineralizados
 - Set di detergente per acciaio inossidabile e liquido di risciacquo demineralizzato



NO STAIN

- Ref: NST – 500ml**
- No stain
 - Anti-tache
 - Fleckstop
 - Vlekstop
 - Anti-Manchas
 - Senza macchia



REMOVE STAIN

- Ref: RST – 500ml**
- Oil and grease remover
 - Nettoyage huile et graisse
 - Öl –und Fettentferner
 - Olie –en vetverwijderaar
 - Quitamachas de Grasa y aceite
 - Rimozione di olio e grasso



BATYLINE®, COAXXS® & STAMSKIN®

BATYLINE®, COAXXS® & STAMSKIN® MAINTENANCE KIT

- Ref: BCC – 500ml**
- Batyline®, Coaxxs® & Stamskin® cleaner set
 - Nettoyant Batyline®, Coaxxs® & Stamskin® - set
 - Batyline®, Coaxxs® und Stamskin® Reiniger - set
 - Batyline®, Coaxxs® en Stamskin® reiniger - set
 - Limpiador para Batyline®, Coaxxs® & Stamskin® - set
 - Limpiador Batyline®, Coaxxs® & Stamskin® - set



GLASS / VERRE / GLAS GLAS / VIDRIO / VETRO

HEAVY DUTY GLASS CLEANER

- Ref: GLHC – 200ml**
- Heavy Duty Glass Cleaner - set
 - Produit fort pour nettoyer le verre - set
 - Starke Glasreiniger - set
 - Sterke glasreiniger - set
 - Limpiacristales extra fuerte - set
 - Potente pulitore per vetro - set



You can find more information about our maintenance products in our maintenance catalogue. Vous pouvez trouver plus d'informations sur nos produits d'entretien dans notre catalogue d'entretien. Mehr Informationen zu unseren Pflegeprodukten finden Sie in unserem Pflegekatalog. Meer informatie betreffende onze onderhoudsproducten kan u vinden in onze onderhoudscatalogus. Potete trovare ulteriori informazioni circa i nostri prodotti sul nostro catalogo manutenzione. Puede encontrar más información sobre nuestros productos para mantenimiento en nuestro catálogo de mantenimiento.

CUSHIONS TEX

AS ONLY THE BEST IS GOOD ENOUGH, all Royal Botania textiles are woven of 100% solution-dyed acrylic fibre; your guarantee for optimal water -and UV resistance, and of course many years of premium comfort. TOUS NOS TISSUS Royal Botania sont 100% fibre acrylic et teints dans la masse: votre garantie pour une résistance aux UV et à l'eau et bien sûr plusieurs années d'un confort optimum. DA NUR DAS BESTE GUT GENUG IST, werden alle Royal Botania-Stoffe aus 100% düsengefärbten Acrylfasern hergestellt. Mit diesen erstklassigen Stoffen können wir Ihnen den bestmöglichen Feuchtigkeits- und UV-Schutz garantieren

GEZIEN ENKEL HET BESTE goed genoeg is, zijn alle Royal Botania stoffen gewoven uit in de massa gekleurde acrylaat vezel; uw zekerheid voor optimale water - en UV resistentie en tevens voor vele jaren optimaal comfort. COSÌ COME SOLO IL MEGLIO è buono abbastanza, tutti i tessuti Royal Botania sono prodotti con fibra 100% acrilica tinta in pasta, la Vostra garanzia per una resistenza all'acqua ed ai raggi UV ottimale e, naturalmente, per molti anni di massimo comfort. VISTO QUE SÓLO EL MEJOR es suficiente, todas las telas han tejido en 100% fibra acrílica teñida en masa; resiste a la decoloración del agua y del sol, y también una garantía para un confort óptimo.

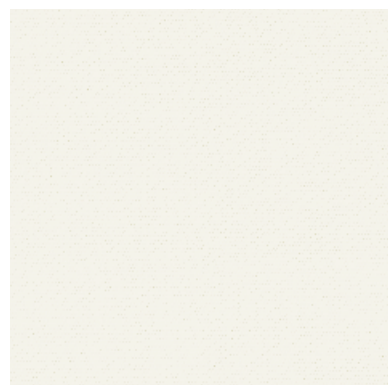

White Basic REF: WU Cat.: A

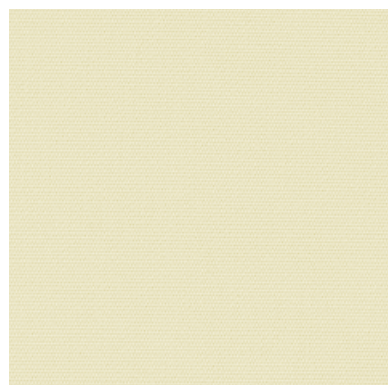

Ecru Basic REF: EU Cat.: A

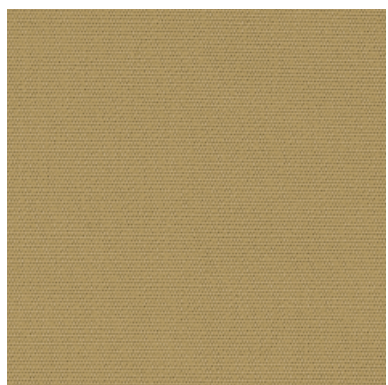

Mocca Basic REF: MU Cat.: A

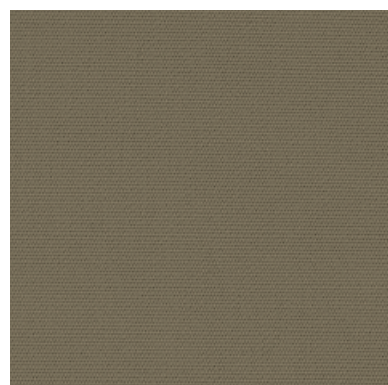

Cappuccino Basic REF: CAU Cat.: A



Rock Basic REF: ROU Cat.: A

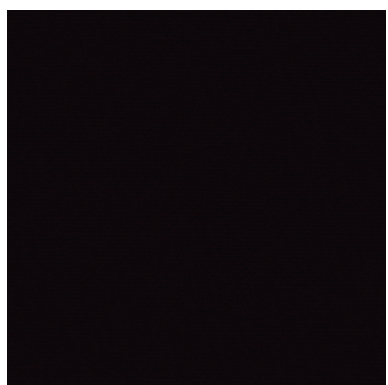

Chocolat Basic REF: CHU Cat.: A

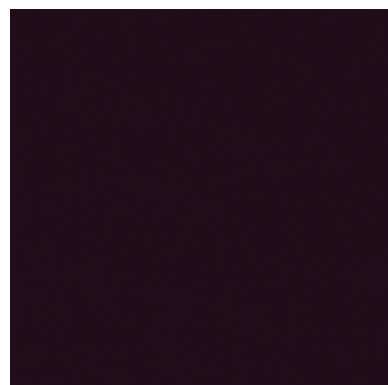

Aubergine Basic REF: AUU Cat.: A

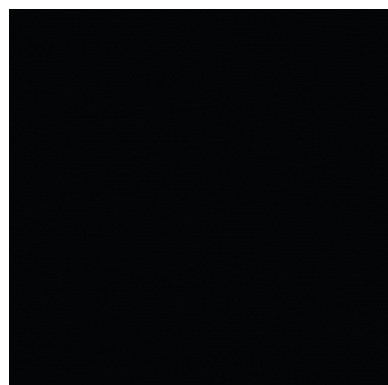

Black Basic REF: ZU Cat.: A



Violet Basic REF: VIU Cat.: A

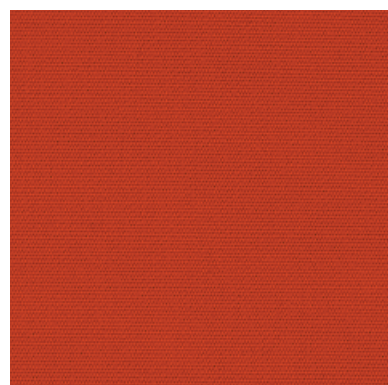

Sienna Basic REF: SIU Cat.: A

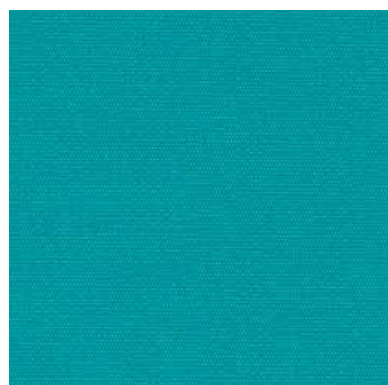

Aqua Basic REF: AQU Cat.: A



Navy Blue REF: NBU Cat.: A

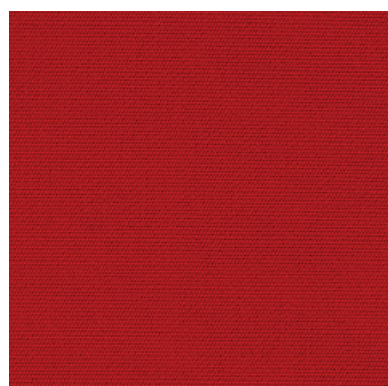

Red Basic REF: RU Cat.: A

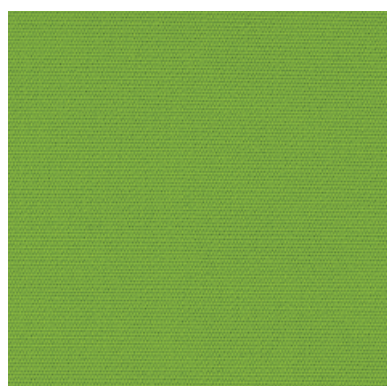

Lime Basic REF: LU Cat.: A



White Flax REF: WF Cat.: B



Ecru Flax REF: EF Cat.: B



Feather Flax REF: FF Cat.: B



Mocca Flax REF: MF Cat.: B



Cappuccino Flax REF: CAF Cat.: B



Aqua Flax REF: AQF Cat.: B



Beach Flax REF: BF Cat.: B



Lavender Flax REF: LF Cat.: B



Electric Blue Flax REF: EBF Cat.: B



Navy Blue Flax REF: NBF Cat.: B



Plum Flax REF: PF Cat.: B

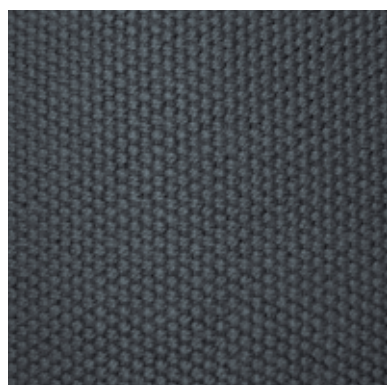

Rock Flax REF: ROF Cat.: B



Limetree Flax REF: LTF Cat.: B

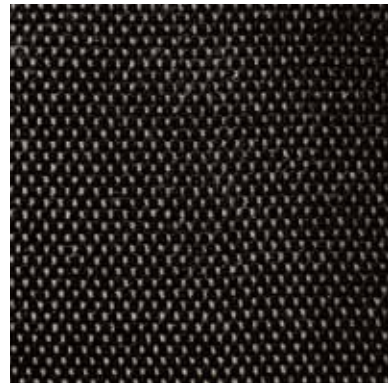

Marble Flax REF: MAF Cat.: B



Chocolat Flax REF: CHF Cat.: B



Black Flax REF: ZF Cat.: B

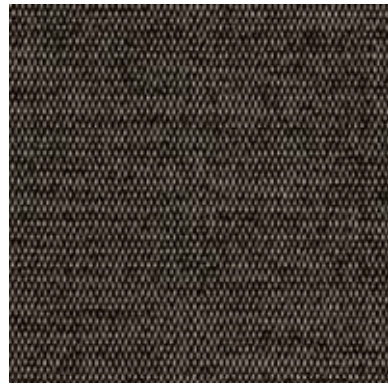

Chocolat Senso REF: CHS Cat.: C

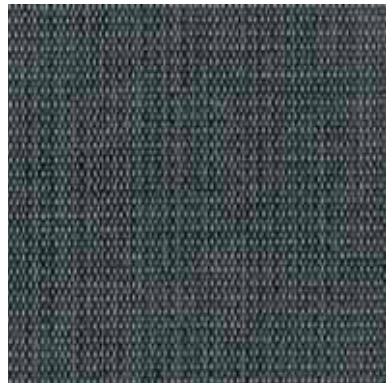

Rock Senso REF: ROS Cat.: C



Black Senso REF: ZS Cat.: C

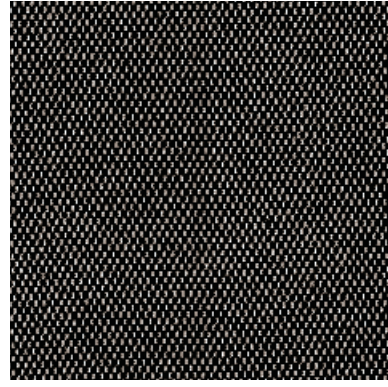

Tuxedo Linen REF: TUL Cat.: B

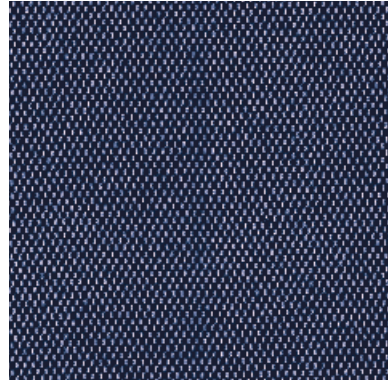

Denim Linen REF: DEL Cat.: B

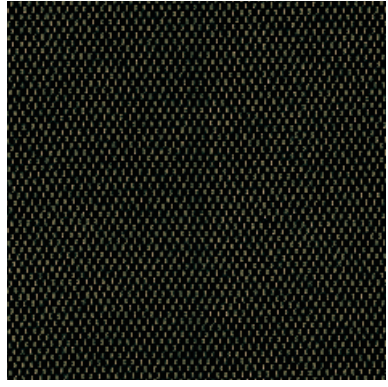

Cocoa Linen REF: COL Cat.: B



Citrus Senso REF: CS Cat.: C



Red Senso REF: RS Cat.: C



Beach Blue Senso REF: BBS Cat.: C

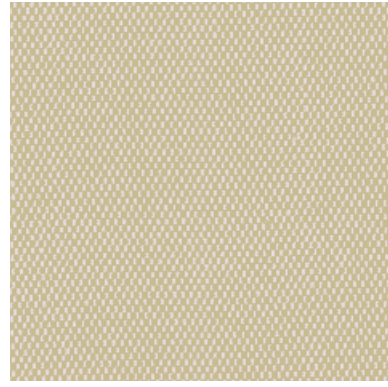

Natural Linen REF: NAL Cat.: B

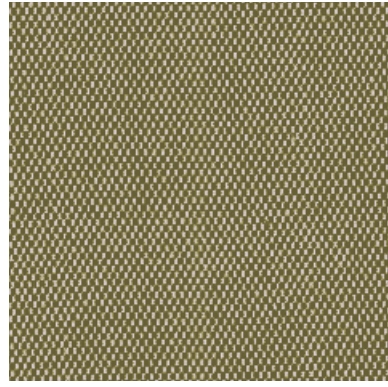

Nougat Linen REF: NOL Cat.: B

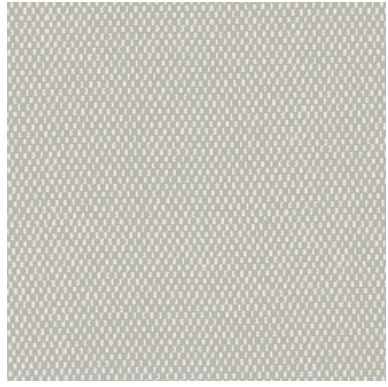

Frost Linen REF: FL Cat.: B

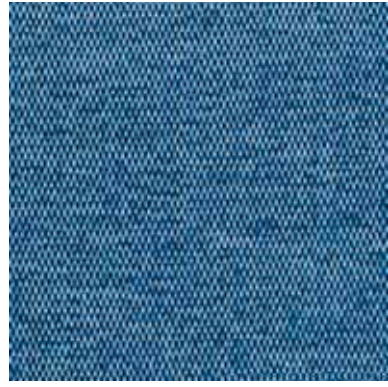

Ise Blue Senso REF: IBS Cat.: C

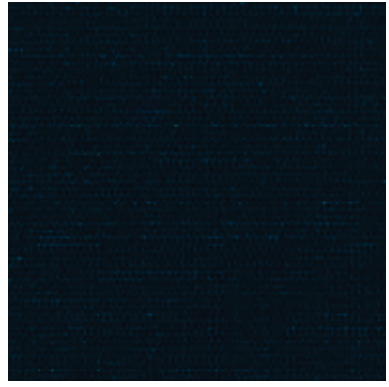

New Navy Blue Senso REF: NBS Cat.: C



Beach Blue White Bloom REF: BBWB Cat.: C

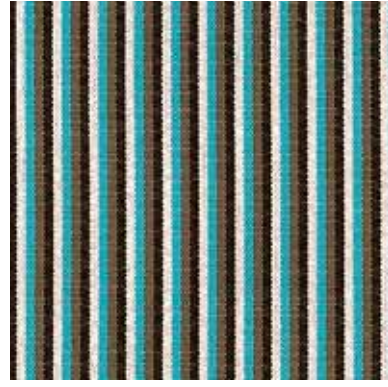

Aqua Sticks REF: AQS Cat.: B

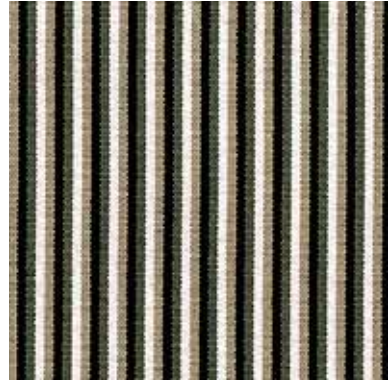

Pepper Sticks REF: PES Cat.: B



White Senso REF: WS Cat.: C



Cappuccino White Bloom REF: CWB Cat.: C



White Jazz REF: WJ Cat.: C



Cappuccino Jazz REF: CAJ Cat.: C



Ecru Senso REF: ES Cat.: C



Cappuccino Senso REF: CAS Cat.: C



Mocca Senso REF: MS Cat.: C

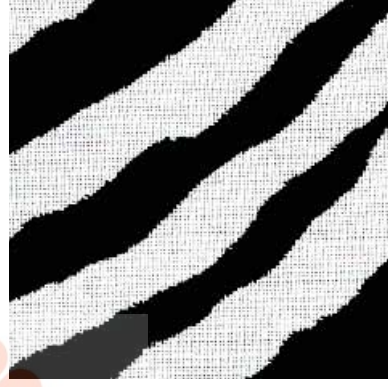

Black Jazz REF: ZJ Cat.: C



Cappuccino Bubbles REF: CAB Cat.: C

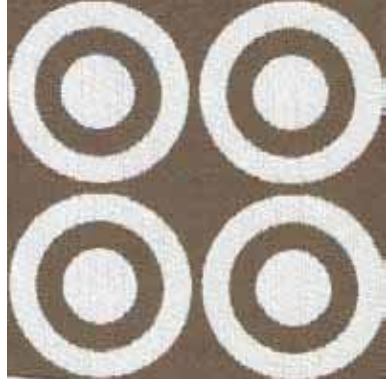

White Bubbles REF: WB Cat.: C

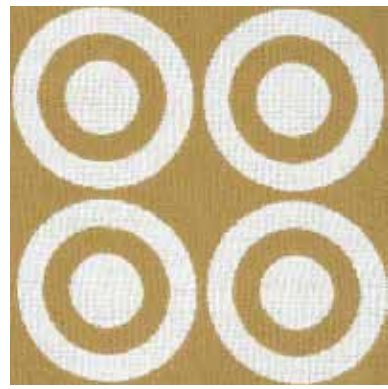

Mocca Bubbles REF: MB Cat.: C

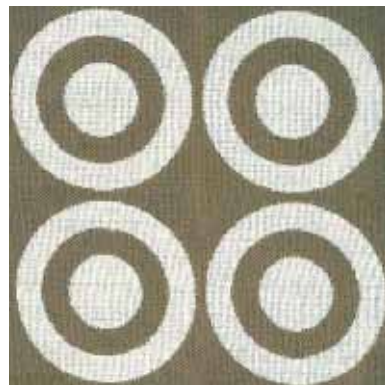

Grey Bubbles REF: GB Cat.: C

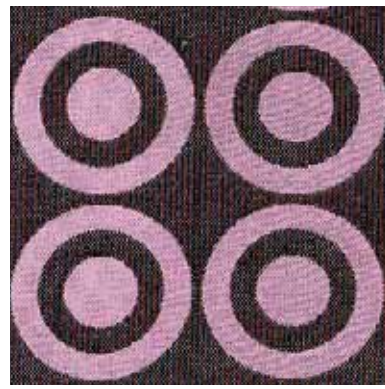

Violet Bubbles REF: VB Cat.: C

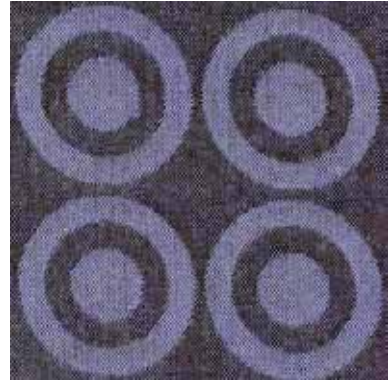

Aubergine Bubbles REF: AUB Cat.: C



White Transat REF: TW Cat.: B

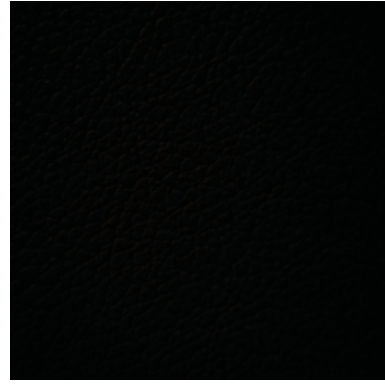

Black Transat REF: TB Cat.: B

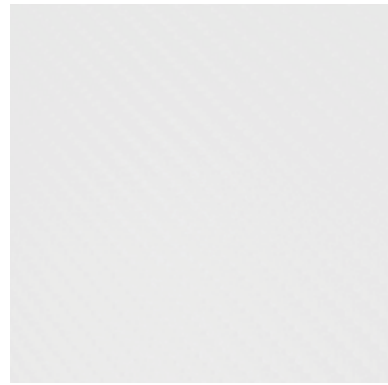

White Carbon REF: WC Cat.: D



Black Carbon REF: ZC Cat.: D



Cappuccino Carbon REF: CAC Cat.: D

BATYLINE BAT

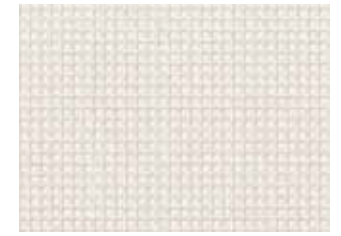

REF: ...WU



REF: ...EU

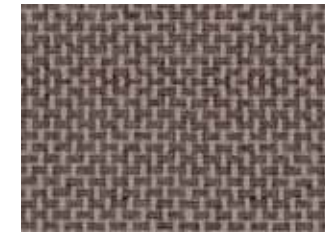

REF: ...CAU

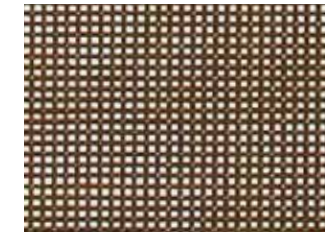

REF: ...BRU



REF: ...SU

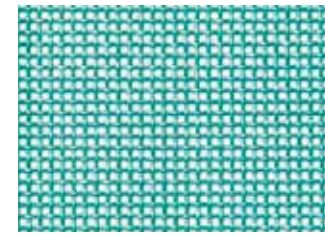

REF: ...TOU

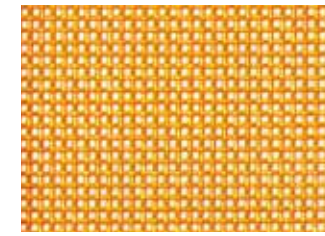

REF: ...ORU

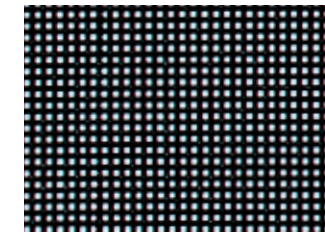

REF: ...ZU

THE SLINGS on metal framed chairs and loungers are made of Batyline® fabrics, a woven polyester fibre protected by a PVC coating. This coating guarantees exceptional resistance to climatic conditions and UV exposure. The fact that there is no moisture absorption results in quick-drying action, little sensitivity to staining, and simplicity in cleaning. LES TOILES des sièges et chaises longues en métal sont réalisées en Batyline®, une fibre de polyester recouverte d'un revêtement en PVC et tissée. Le revêtement synthétique est garant d'une résistance exceptionnelle aux UV et aux conditions climatiques. Vu qu'elle n'absorbe nullement l'humidité, cette matière sèche rapidement, se tache difficilement et est facile à nettoyer. STÜHLE, SESSEL und Liegen mit Metallgestell sind mit Batyline-Gewebe, einer gewobenen Polyesterfaser mit PCV-Beschichtung, Gespannt. Die Kunststoffbeschichtung garantiert eine extreme Wetter- und UV-Beständigkeit. Das hat zur Folge, dass das Gewebe schnell trocknet, unempfindlich auf Flecken reagiert und einfach zu reinigen ist. VOOR DE ZIT- EN RUGBESPANNING van onze stoelen en ligbedden maken wij gebruik van Batyline® weefsel, een polyestervezel die wordt voorzien van een PVC-coating en vervolgens geweven. De kunststof coating staat garant voor een uitzonderlijke weer- en UV bestendigheid. Het feit dat geen vocht wordt opgenomen resulteert in een snelle droging, geringe vlekgevoeligheid, en eenvoudige reiniging. I TELI DELLE POLTRONE e dei lettini con strutture in metallo sono realizzati in tessuto batyline®, una fibra di poliestere rivestita di PVC e tessuta. Il rivestimento sintetico è garante di una resistenza eccezionale agli UV e alle condizioni climatiche. Dato che non assorbe l'umidità, questo materiale si asciuga rapidamente, si macchia difficilmente ed è facile da pulire. PARA EL ASIENTO y la espalda de nuestras sillas utilizamos batyline® tejido, una fibra de poliéster se dota de un recubrimiento de PVC antes de tejerse. El recubrimiento sintético garantiza una excepcional resistencia a las condiciones meteorológicas y a los rayos UV. El que no absorba humedad, hace que se seque rápido, sea muy poco sensible a las manchas y se limpie fácilmente.

CoaXXS® CX



REF: ...FO



REF: ...CA



REF: ...ZU

THE NAME CoaXXS® refers to the coaxial structure of the highly stretch-resistant polyester core and the outer synthetic skin. The result is not only "Xtra Xtra Strong", but moreover, creates the synthetic fibre with the most natural appearance available on the market. LE NOM CoaXXS® se réfère à la structure coaxiale d'un noyau en polyester extrêmement résistante, et d'une peau synthétique extérieure. Le résultat n'est pas seulement "Xtra Xtra Solide", mais en plus la fibre synthétique a l'apparence la plus naturelle du marché. DER NAME CoaXXS® bezieht sich auf die koaxiale Struktur des extrem dehnungsresistenten Polyester Kernes der mit Kunststoff bezogen ist, welcher mit einer Kunststoffhaut bezogen ist. Das Ergebnis ist nicht nur "Xtra Xtra Stark", sondern der natürlichst wirkende synthetische Stoff auf dem Markt. DE NAAM CoaXXS® verwijst naar de coaxiale opbouw van een extreem rekvaste polyesterkern, bekleed met een gekleurde kunststofhuid. Het resultaat is niet enkel "Xtra Xtra Sterk" maar bovendien is dit de meest natuurlijk ogende kunststofvezel op de markt. IL NOME CoaXXS® si riferisce alla struttura coassiale dell'anima in poliestere, estremamente resistente alle tensioni, ed al rivestimento sintetico esterno. Il risultato non è solo "Xtra Xtra Strong", ma diventa anche la fibra sintetica con l'aspetto più naturale sul mercato. Una garanzia per uno stile altamente di classe sia all'interno che all'esterno. EL NOMBRE CoaXXS® hace referencia a la estructura coaxial del cáñamo de fibra de poliéster, y la membrana sintética exterior. El resultado no es sólo "Xtra Xtra Strong", sino sobretodo la fibra sintética con la apariencia más natural del mercado.

TOWELS



REF: PIL TWW

210 x 95



REF: PIL TWG

210 x 95

DECORATIVE CUSHIONS

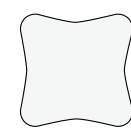

PIL 40.. : (Cat.: A)
PIL 40.. : (Cat.: B)
PIL 40.. : (Cat.: C)
PIL 40.. : (Cat.: D)

40 x 40

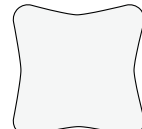

PIL 50.. : (Cat.: A)
PIL 50.. : (Cat.: B)
PIL 50.. : (Cat.: C)
PIL 50.. : (Cat.: D)

50 x 50

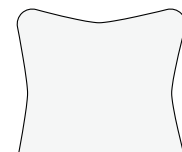

PIL 70.. : (Cat.: A)
PIL 70.. : (Cat.: B)
PIL 70.. : (Cat.: C)
PIL 70.. : (Cat.: D)

70 x 70

STAINLESS STEEL

StSt

STAINLESS STEEL is a ferrous alloy with increased corrosion resistance due to the addition of chrome and nickel. In order to obtain a chrome-oxide and nickel-oxide surface that is of a high grade purity and homogeneity, thus achieving optimal corrosion resistance, the Royal Botania frames are etched and subjected to a passivating process as a standard treatment. Chlorine is RFS' greatest enemy and can cause a type of corrosion that is known as "pitting". For that reason, it is recommended that in locations near the seacoast – since sea salt is sodium chloride - the metal be given a surface made as smooth as possible in order to increase its resistance to corrosion even further. The smoother the surface, the less porous it is. The lower the porosity, the lower the possibility of dirt deposits accumulating on the metal surface, and thus the lower the risk of corrosion. The furniture frames of the FOLD, MIXT, WAVE, SURF, FLEXY, and EZ collections come standard in electropolished finish. For the NINIX, O-ZON and QT ranges we recommend the optional electro-polishing treatment of the frame if it is to be used in a corrosive environment. L'ACIER INOXYDABLE est mieux connu sous le nom d'inox. Il s'agit d'un alliage de fer dont la résistance à la corrosion est accrue par ajout de chrome et de nickel. Afin que la surface d'oxyde de chrome et de nickel soit aussi pure et homogène que possible et, donc, pour que la résistance à la corrosion soit optimale, les cadres Royal Botania subissent une attaque chimique avant d'être passivés. Le chlore est le principal ennemi de l'inox et peut provoquer une corrosion par piqûres ou perforante. C'est la raison pour laquelle à proximité de la côte (le sel marin est en effet du chlorure de sodium), il est conseillé de polir au maximum la surface du métal afin d'augmenter encore la résistance à la corrosion. Car plus la surface est polie, moins elle est poreuse. Au plus la porosité est faible, au plus le risque de dépôt de souillures sur la surface du métal diminue, et donc, le risque de corrosion s'en trouve également réduit. Les cadres des meubles des collections FOLD, MIXT, WAVE, SURF, FLEXY, ET EZ subissent standard une électropolissage. Pour les gammes NINIX, O-ZON et QT, pour tout usage en milieu corrosif, nous conseillons l'électropolissage du cadre du meuble, offert en option. ROSTFREIER STAHL ist besser bekannt als Nirosta oder EDELSTAHL. Die Korrosionsbeständigkeit der Eisenlegierung wird durch die Zugabe von Chrom und Nickel erhöht. Um eine möglichst reine und homogene Chrom- und Nickeloxidschicht, und damit eine optimale Korrosionsbeständigkeit zu erhalten, werden die Rahmen der Royal-Botania-Collection serienmäßig passiviert. Chlor ist der größte Feind von Nirosta und kann Lochkorrosion - bekannt als "Pitting"- verursachen. Aus diesen Gründen sollte eine Metalloberfläche in Küstennähe möglichst eben sein, denn je glatter die Oberfläche ist, um so weniger porös ist sie. Je geringer die Porosität, desto geringer die Gefahr für Schmutzanhaftungen auf der Metalloberfläche und desto geringer die Korrosionsgefahr. Die Möbelrahmen von die FOLD, MIXT, WAVE, SURF, FLEXY, und EZ Linien, sind schon serienmäßig elektropoliert. Für NINIX, O-ZON und QT empfehlen wir für die Verwendung in einer korrosiven Umgebung das optionale Elektropolieren des Möbelrahmens. ROESTVAST STAAL is beter bekend als RVS of Inox. Het betreft een ijzerlegering, waarbij de corrosiebestendigheid verhoogd wordt door toevoeging van chroom en nikkel. Teneinde een zo zuiver en homogeen mogelijke chroom- en nikkeloxide huid, en dus een optimale corrosiebestendigheid te verkrijgen worden de Royal Botania frames standaard gepassiveerd. Chloor is de grootste vijand van RVS, en kan putvormige corrosie, gekend als "pitting" veroorzaken. Om die reden is het in de nabijheid van de kust –zeezout is immers natriumchloride- aangewezen, het metaal een zo glad mogelijk oppervlak te geven, teneinde de corrosiebestendigheid nog verder op te voeren. Immers hoe gladder het oppervlak hoe minder poreus. Hoe lager de porositeit, hoe geringer de kans op vastzetting van verontreiniging op het metaaloppervlak, en dus hoe lager het risico op corrosie. De frames

uit de collecties FOLD, MIXT, WAVE, SURF, FLEXY, en EZ worden standaard geëlektropolijst. Voor de collecties NINIX, O-ZON en QT adviseren wij voor toepassing in een corrosief milieu het optioneel elektropolijsten van het meubelframe. L'ACCIAIO INOSSIDABILE è meglio conosciuto sotto il nome di inox. È una lega di ferro la cui resistenza alla corrosione è aumentata con l'aggiunta di cromo e di nichel. Per ottenere una superficie di ossido di cromo e di ossido di nichel, la più pura e omogenea possibile, con un'ottima resistenza alla corrosione, i componenti Royal Botania sono sottoposti ad un processo di attacco chimico prima di essere trattati in armatura. Il cloro è il principale nemico dell'inox. Può causare una corrosione puntiforme. Per questo, in prossimità del mare (il sale di mare è cloruro di sodio), è consigliato bruniare al massimo la superficie del metallo per aumentare ancora la resistenza alla corrosione. In effetti, più la superficie è stata brunita, meno è porosa. Più la porosità diminuisce e più si riduce il rischio di deposito di sporcizia sulla superficie del metallo e quindi si minimizza il rischio di corrosione. Le strutture delle collezioni FOLD, MIXT, WAVE, SURF, FLEXY, e EZ saranno prodotte solo con finitura elettrolitica. Per le collezioni NINIX, O-ZON e QT raccomandiamo la finitura elettrolitica delle strutture, disponibile come opzione, nel caso di utilizzo dei mobili in ambienti considerati corrosivi. EL ACERO INOXIDABLE se conoce mejor bajo los nombres de RVS o Inox. Se trata de una aleación de hierro cuya resistencia anticorrosiva se mejora añadiendo cromo y níquel. A fin de obtener una capa de óxido de cromo y níquel lo más homogénea y pura posible, es decir para obtener una resistencia anticorrosiva óptima, los marcos Royal Botania vienen grabados y pasivados en su versión estándar. El cloro es el mayor enemigo del RVS y puede causar una corrosión en forma de hoyitos llamado "pitting". Por eso, en las cercanías de la costa (la sal marina es cloruro sódico) es indicado dotar al metal de una superficie lo más lisa posible a fin de incrementar aún más la resistencia a la corrosión. Pues más lisa es la superficie, menos porosa resulta, y más baja es la porosidad, menos probable es que la suciedad se adhiera a la superficie metálica y cause corrosión. Las armaduras de los muebles de la colección FOLD, MIXT, WAVE, SURF, FLEXY, y EZ vienen de serie en una versión electropulida. Para las colecciones NINIX, O-ZON y QT os recomendamos optar por la versión electropulida si los muebles estarán en un entorno corrosivo.



TEAK

TK

AS ROYAL BOTANIA never compromises on quality, only mature carefully selected teakwood is used, all of it harvested in strict accordance with our environmental policies. Teak wood is produced by the Tectona Grandis, a tree that under favourable conditions can attain a height of up to 45 m, with a trunk diameter up to 2.4 meters. The wood's renowned durability is due to its high content of natural oils. The limited absorption of moisture protects the wood from warping and thus gives the wood its enormous stability. In addition, the wood is highly resistant to attacks by pests. It is because of these qualities, as well as its exceptionally attractive hue and structure, that teak has deservedly received the title of "the noblest of all wood types"

The teak tree originates mainly in what is known as the Golden Triangle, this being the region of Laos, Myanmar (formerly Burma), and Thailand. Many centuries ago, people were already aware of the properties of teakwood, and plantations were established in Africa, South America, and other South-East Asian countries. Soil and climate conditions have a significant impact on the quality of the wood, and as such, only plantation wood from the Tectona Grandis tree grown in Indonesia has the same superior qualities as wood harvested from forest-grown trees. Following the colonial era, the Indonesian plantations came to be supervised by the local population. Today they are operated under the jurisdiction of the state-run institution Perum Perhutani. Only wood that has matured possesses the much valued qualities of great stability and resistance. Mature wood is ready to be felled after 75 to 80 years. After the drying operation, the further processing stages are of great importance.

The wood's constructive strength in fact depends to a large extent on the precision of its processing. COMME ROYAL BOTANIA n'accepte jamais de compromis quand il s'agit de la qualité, seul le bois de teck mature, sélectionné avec soin, est utilisé, coupé dans le respect strict de nos mesures environnementales. Le bois est issu du Tectona Grandis, un arbre qui, dans des circonstances de croissance favorables, peut atteindre 45 m de haut et dont

le tronc peut se développer jusqu'à 2,4 mètres de diamètre. Sa solidité universellement reconnue trouve son origine dans sa forte teneur en huiles naturelles. Vu que l'absorption d'eau est minime, le bois ne travaille pas beaucoup et est donc extrêmement stable. En outre, le bois offre une forte résistance aux agressions de produits chimiques ainsi qu'aux attaques des vermines. Ces qualités d'une part et sa couleur et sa structure exceptionnellement belles d'autre part en font le plus noble de tous les types de bois. Le teck est principalement originaire du triangle d'or, à savoir la région constituée par le Laos, le Myanmar (ancienne Birmanie) et la Thaïlande. Les qualités du teck sont reconnues depuis plusieurs siècles déjà et, en conséquence, des plantations ont été réalisées en Afrique, en Amérique du Sud et dans d'autres pays du Sud-est asiatique. Etant donné que la nature du sol et les conditions climatologiques influencent fortement la qualité du bois, seul le bois indonésien du Tectona Grandis peut se vanter de posséder les mêmes qualités que le bois naturel. Après l'époque coloniale, les plantations indonésiennes sont passées sous le contrôle de la population locale et sont à présent supervisées par un organe public, le Perum Perhutani. Seul le bois adulte possède les qualités recherchées que sont la stabilité et la résistance. Le bois est bon pour l'abattage après 75 à 80 ans. Le traitement dont fait l'objet le bois après le séchage assume naturellement également une importance capitale. La résistance de la construction est en effet largement déterminée par la précision du traitement. DA ROYAL BOTANIA niemals Kompromisse bei der Qualität eingeht, wird nur ausgereiftes und sorgfältig ausgesuchtes Teakholz verwendet. Die Rodung findet unter strikter Befolgung der Umweltschutzmaßnahmen statt. Das Holz stammt von der "Tectona Grandis", einem Baum, der unter günstigen Wachstumsbedingungen bis zu 45m hoch wird und einen Stammdurchmesser von 2,4 Metern erreichen kann. Durch die hohe Konzentration an natürlichen Ölen erhält das Holz seine oftmals gepriesene Beständigkeit. Die Öle verhindern die Aufnahme von zu viel Feuchtigkeit, woraus eine große Stabilität des Holzes resultiert. Darüber hinaus besitzt das Holz eine hohe Widerstandskraft gegen die Einwirkungen von Chemikalien und Ungeziefer. Diese vorteilhaften Qualitäten sowie die außergewöhnlich schönen Farben und Strukturen verdankt das Holz seinem Ruf als einer der nobelsten Holzsorten dieser Erde. Der Teakbaum stammt hauptsächlich aus dem Goldenen Dreieck, der Region von Laos, Myanmar (ehemals Burma) und Thailand. Die Qualitäten des Teakholzes wurden bereits vor einigen Jahrhunderten erkannt und es wurden Plantagen in Afrika, Südamerika und anderen südostasiatischen Staaten angelegt. Da die Bodenzusammensetzung und die klimatischen Bedingungen einen wichtigen Einfluss auf die Qualität des Holzes haben, kann nur das indonesische Holz der "Tectona Grandis" gleiche Qualitäten wie das natürliche Holz vorweisen. Die indonesischen Plantagen fielen nach der Kolonialzeit in die Hände der lokalen Bevölkerung und werden heute von der staatlichen Institution "Perum Perhutani" beaufsichtigt. Nur das ausgewachsene Holz verfügt über die Qualitäten der Stabilität und Widerstandsfähigkeit. Das Holz ist nach 75 bis 80 Jahren schlagreif. Nach der Trocknung spielt die weitere Verarbeitung, vor allem für die Außenmöbel eine wichtige Rolle, da diese schwersten Bedingungen standhalten müssen.



Der Teakbaum stammt hauptsächlich aus dem Goldenen Dreieck, der Region von Laos, Myanmar (ehemals Burma) und Thailand. Die Qualitäten des Teakholzes wurden bereits vor einigen Jahrhunderten erkannt und es wurden Plantagen in Afrika, Südamerika und anderen südostasiatischen Staaten angelegt. Da die Bodenzusammensetzung und die klimatischen Bedingungen einen wichtigen Einfluss auf die Qualität des Holzes haben, kann nur das indonesische Holz der "Tectona Grandis" gleiche Qualitäten wie das natürliche Holz vorweisen. Die indonesischen Plantagen fielen nach der Kolonialzeit in die Hände der lokalen Bevölkerung und werden heute von der staatlichen Institution "Perum Perhutani" beaufsichtigt. Nur das ausgewachsene Holz verfügt über die Qualitäten der Stabilität und Widerstandsfähigkeit. Das Holz ist nach 75 bis 80 Jahren schlagreif. Nach der Trocknung spielt die weitere Verarbeitung, vor allem für die Außenmöbel eine wichtige Rolle, da diese schwersten Bedingungen standhalten müssen.

VERMITS ROYAL BOTANIA geen toegevingen doet op gebied van kwaliteit gebruiken wij enkel zorgvuldig geselecteerd,

VERMITS ROYAL BOTANIA geen toegevingen doet op gebied van kwaliteit gebruiken wij enkel zorgvuldig geselecteerd,

WINTER COVERS

volgroeid teakhout, dat geogst wordt volgens strikte normen op gebied van milieubehoud. Het hout is afkomstig van de Tectona Grandis, een boom die onder gunstige groeiomstandigheden tot 45m hoog kan worden met een stamdiameter tot 2,4 meter. De alom geprezen duurzaamheid vindt zijn oorsprong in het hoge gehalte aan natuurlijke oliën. De daaruit volgende geringe opname van vocht zorgt voor geringe werking, resulterend in een enorme stabiliteit. Bovendien biedt het hout een hoge resistentie tegen inwerking van chemicaliën, alsook tegen aantasting door ongedierte. Aan deze kwaliteiten en de uitzonderlijk mooie kleur en structuur dankt het de titel "de nobelste der houtsoorten"

De teakboom, is vooral afkomstig uit de Golden Triangle zijnde de regio van Laos, Myanmar (voormalig Birma) en Thailand. De kwaliteiten van het teakhout werden reeds enkele eeuwen geleden ingezien en er werd overgegaan tot aanleg van plantages in Afrika, Zuid-Amerika en andere Zuidoost Aziatische landen. Daar de bodemgesteldheid en de klimatologische omstandigheden een belangrijke invloed hebben op de kwaliteit van het hout, kan enkel het Indonesische hout van de Tectona Grandis bogen op gelijke kwaliteiten als het natuurlijke hout. De Indonesische plantages kwamen na het koloniaal tijdperk, onder toezicht van de lokale bevolking, en worden heden gesuperviseerd door de staatsinstelling Perum Perhutani.

Enkel het volwassen hout beschikt over de geprezen kwaliteiten qua stabiliteit en resistentie. Het hout is kaprijp na 75 à 80 jaar. Na de droging is natuurlijk ook de verdere verwerking van belang. Vooral voor buitenmeubelen gezien deze de zwaarste beproevingen moeten doorstaan. DATO CHE ROYAL BOTANIA non accetta compromessi sulla qualità, viene accuratamente selezionato solo legno di teak maturo di prima scelta, prelevato seguendo le rigide politiche ambientali. Il legno proviene dal Tectona Grandis, un albero che, in condizioni di crescita favorevoli, può raggiungere 45 m di altezza e un diametro di fusto di 2,4 m. La sua durezza universalmente apprezzata trae origine da un tenore elevato di oli naturali. Essendo minimo l'assorbimento d'acqua, il legno non lavora molto e la sua stabilità è enorme. Inoltre, il legno offre un'elevata resistenza all'azione dei prodotti chimici e alle aggressioni dei parassiti. Per queste qualità da un lato e per un colore e una struttura eccezionali dall'altro, il teak è considerato come il più nobile di tutti i tipi di legno.

Il teak è essenzialmente originario del triangolo d'oro o, in altri termini, la regione costituita dal Laos, il Myanmar

(ex Birmania) e la Thailandia. Le qualità del teak sono riconosciute già da vari secoli e, di conseguenza, piantagioni sono state realizzate anche in Africa, in America del Sud e in altri Paesi del sud-est asiatico. Visto che la natura del suolo e le condizioni climatiche influenzano largamente la qualità del legno, solo il legno indonesiano del Tectona Grandis vanta le stesse qualità del legno naturale. Dopo l'epoca coloniale, le piantagioni indonesiane sono passate sotto il controllo della popolazione locale e sono ora sotto la supervisione di un organo pubblico, il Perum Perhutani. Solo il legno adulto possiede le qualità apprezzate di stabilità e resistenza. Il legno è pronto per essere tagliato dopo 75/80 anni. Il trattamento successivo alla stagionatura è anche molto importante, soprattutto per i mobili da esterno dato che sono sottoposti a dure prove. ROYAL BOTANIA ESTA comprometida con la calidad, por ello sólo se usa teca madurada cuidadosamente seleccionada. Todo ello siguiendo estrictamente nuestras políticas medioambientales. La madera proviene del Tectona Grandis, un árbol que bajo circunstancias de crecimiento favorables puede alcanzar una altura de 45 metros con un diámetro de tronco de hasta 2,4 metros. Debe su famosa durabilidad a un alto contenido en aceites naturales por lo que absorbe muy poca humedad. Por consiguiente, la madera 'trabaja' poco y dispone de una enorme estabilidad. Además, es altamente resistente al efecto de sustancias químicas y los daños ocasionados por bichos nocivos. Gracias a estas calidades y a su excepcional color y estructura, la teca es considerada la más noble de las maderas.

El teca es un árbol que se da principalmente en el triángulo de oro en la región de Laos, Myanmar (ex Birmania) y Tailandia. Hace ya muchos siglos que se observaron las calidades de la madera teca por lo cual se empezó a habilitar plantaciones en África, Sudamérica y otros países de Asia sudoriental. Dado que la condición del suelo y las circunstancias climatológicas tienen una importante influencia en la calidad de la madera, sólo la madera indonesia del Tectona Grandis dispone de las mismas calidades que la madera natural. Tras el período colonial, las plantaciones indonesias pasaron al control de la población local, encontrándose hoy en día supervisadas por la institución estatal Perum Perhutani. Sólo la madera adulta dispone de las preciadas calidades de estabilidad y resistencia. La madera puede talarse transcurridos 75 a 80 años. Después del secado, también resulta muy importante la transformación ulterior, sobre todo para la fabricación de muebles exteriores dado que éstos deben resistir a las circunstancias más adversas.

Sólo la madera adulta dispone de las preciadas calidades de estabilidad y resistencia. La madera puede talarse transcurridos 75 a 80 años. Después del secado, también resulta muy importante la transformación ulterior, sobre todo para la fabricación de muebles exteriores dado que éstos deben resistir a las circunstancias más adversas.

Royal Botania offers tailor made winter covers. For more details please refer to pricelist.

Royal Botania propose des housses de protection. Pour plus de détails merci de consulter la liste de prix.

Royal Botania bietet maßgeschneiderte Abdeckungen für den Winter. Mehr Details können Sie der Preisliste entnehmen.

Royal Botania biedt op maat gemaakte wintercovers. Voor meer details zie prijslijst.

Royal Botania ofrece fundas de invierno hechas a medida. Para más detalles consultar la lista de precios.

Royal Botania offre coperture invernali realizzate su misura. Per maggiori dettagli consultare il listino prezzi.

CHAIR COVER

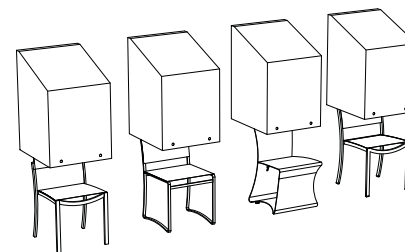

REF: + COVER
ITEM REF:
example: HER 47 COVER

ARMCHAIR COVER

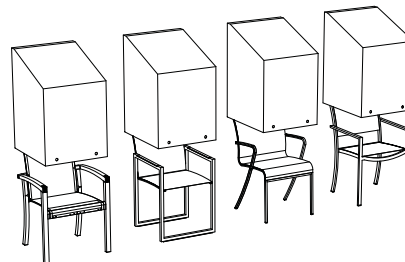

REF: + COVER
ITEM REF:
example: IXIT 55 COVER

LOUNGER COVER

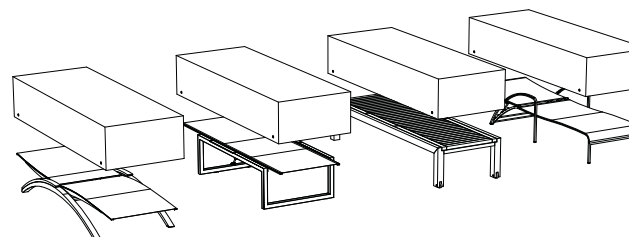

REF: + COVER
ITEM REF:
example: NNX195 COVER

RELAX CHAIR COVER

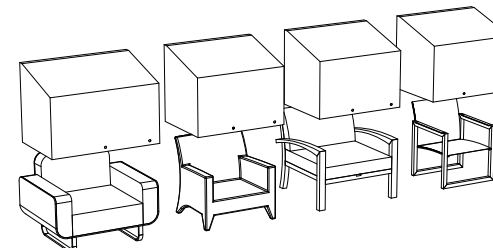

REF: + COVER
ITEM REF:
example: SUD77 COVER

LOUNGE CHAIR COVER (TAILOR MADE)

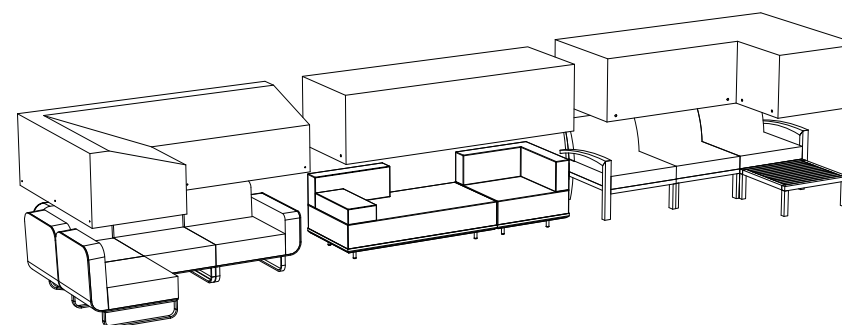

REF: + COVER
(ITEMS)

For every order a clear sketch of your combination is required

TABLE COVERS: (TAILOR MADE) PRICE ON DEMAND

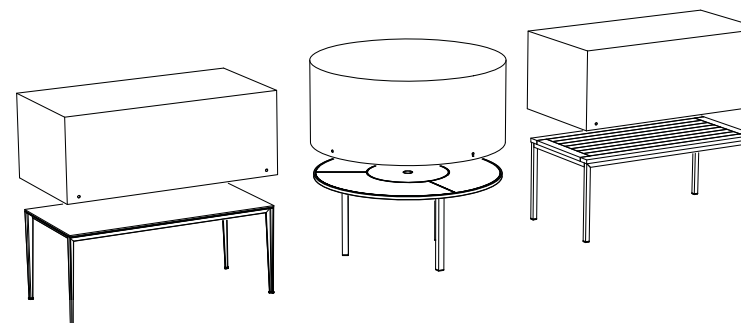

REF: + COVER
ITEM REF:

100% polyester EVA coated waterproof fabric, weight: 200gr/m² color: CAU

WINTERCOVERS



Royal Botania Lighting Collection

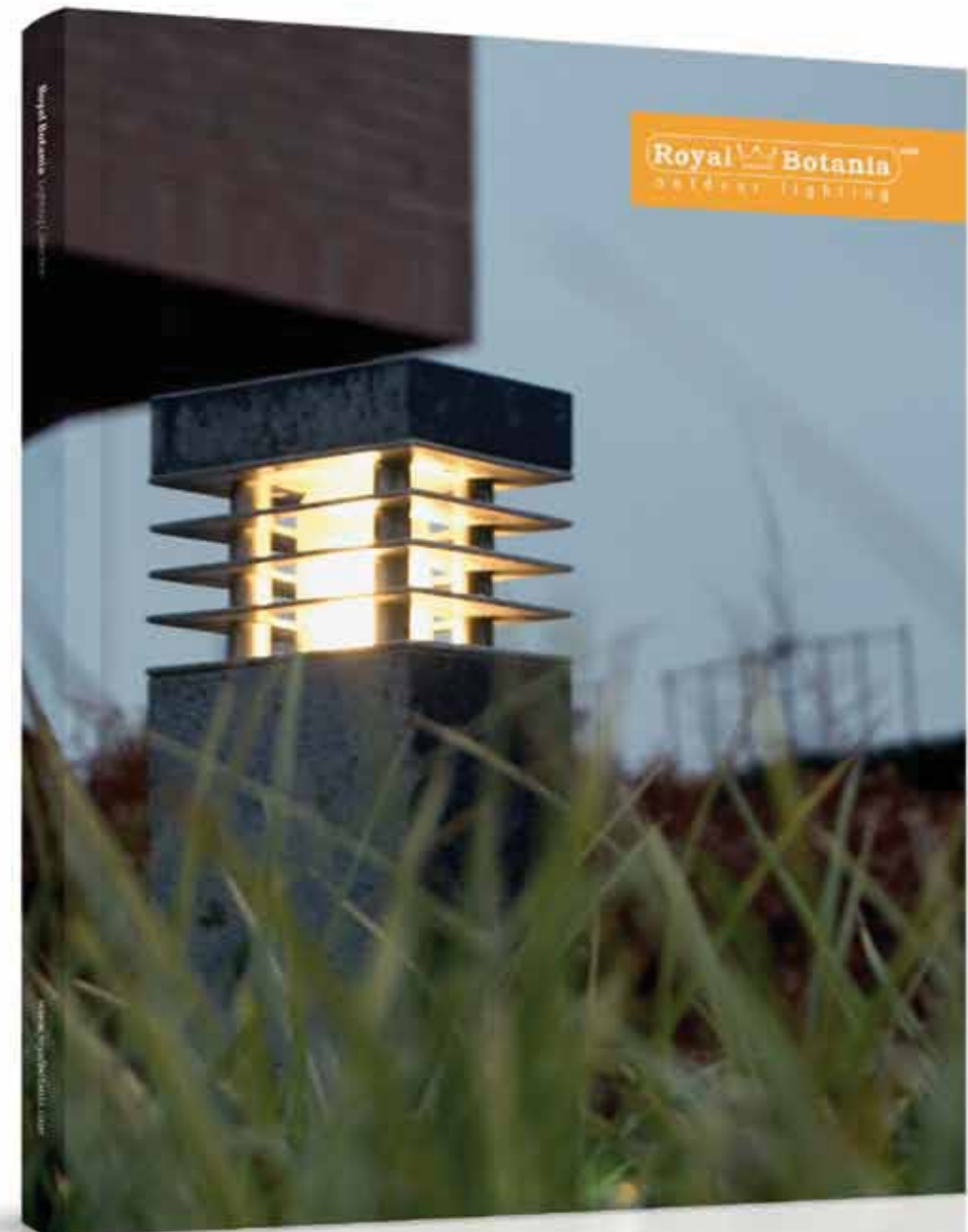

ASK YOUR DEALER FOR OUR COMPLETE
ROYAL BOTANIA OUTDOOR LIGHTING CATALOG
OR VISIT WWW.ROYALBOTANIA.COM



1011



1021



1031



1121



1131



1141



1041



1051

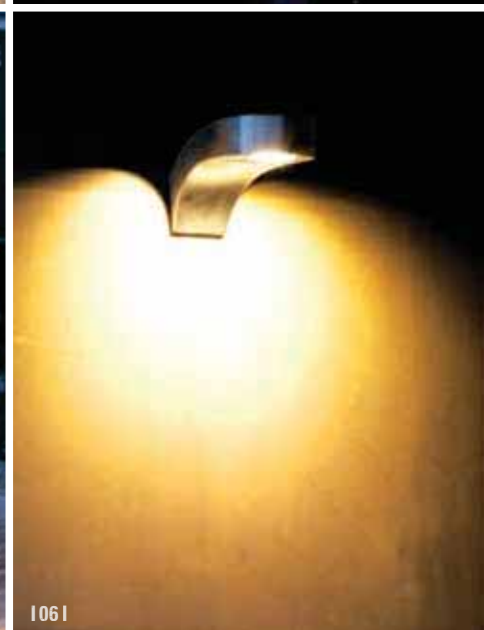

1061



1151



1161



1171



1071



1081

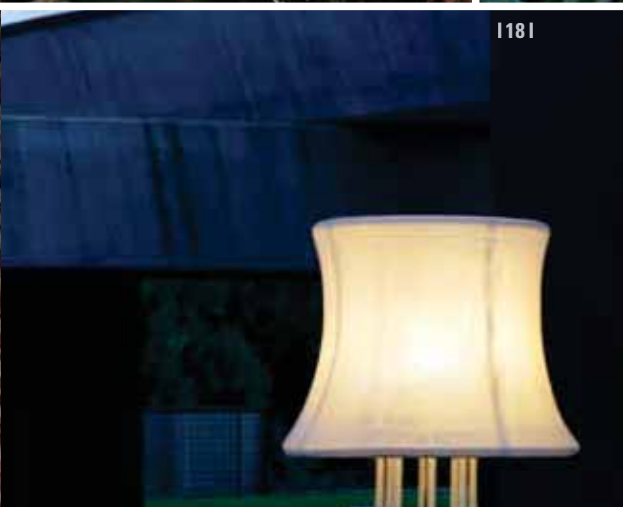

1181

1011 NOCTUS 1021 LOG 1031 Q-BIC 1041 DOME 1051 CLUB 1061 COBRA 1071 RUSTY 1081 OMEGA 1091 BEAMY 1101 LAMPLAIR 1111 ELLIPSE 1121 DOME 1131 LOG 1141 TWIN 1151 DOME 1161 Q-BIC 1171 NORTHPOLE 1181 3D 1191 DOME 1201 DOME 1211 TWIN

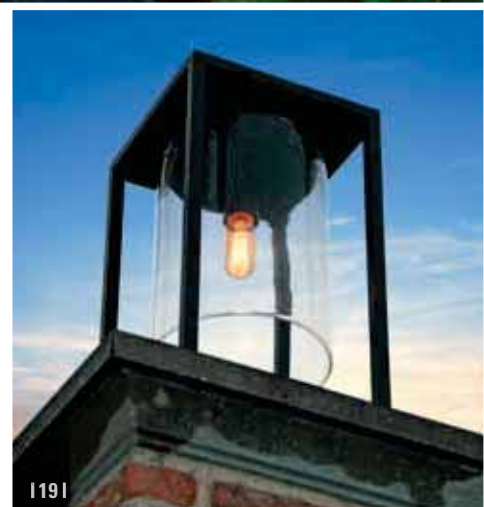

1191



1091



1101



1111



1201



1211

Royal Botania as partner for your projects



FOR A SELECTION OF HOTELS AND RESTAURANTS FURNISHED WITH ROYAL BOTANIA OUTDOOR PRODUCTS, PLEASE REFER TO WWW.ROYALBOTANIA.COM



1011



1061



1071



1021



1031



1081

- 101 | COWORTH PARK, UK
- 102 | OCEAN EMERALD SUPER YACHT
- 103 | GRAND HOTEL KEMPINSKI, GENEVA
- 104 | TSEUNG KWAN O AREA 56, HONG KONG
- 105 | HOTEL W, SINGAPOR
- 106 | K2 COURCHEVEL, FRANCE
- 107 | LES THERMES MARINS, MONACO
- 108 | SCHWARZER ADLER, KITZBÜHEL, AUSTRIA
- 109 | HOTEL W, SINGAPORE
- 110 | HOTEL RIBERACH, PERPIGNAN



1041



1051



1091



1101

OUTDOOR LUXURY
OUTDOOR LIGHTING
BATHROOM FURNITURE



WWW.ROYALBOTANIA.COM

Royal  Botania®

www.royalbotania.com



THE REFERENCE...

