

BOVER

B A R C E L O N A



Los que vivimos cerca del Mediterráneo conocemos todos los matices de la luz.  
Por eso cuando llega la noche la transformamos en pequeños espacios de día.

Wir, die in der Nähe des Mittelmeers leben, kennen alle Abstufungen des Lichts.  
Wenn die Nacht kommt, verwandeln sie in kleine Punkte des Lichts.

Those of us who live near the Mediterranean know all the nuances of light.  
For this reason, when night comes, we transform it into little spacelets of day.

Mediterraneotik gertu bizi garenok ondo ezogutzen ditugu argiaren nabardura guztiak.  
Horregatik, goua datorrenean egun bihurtzen dugu gure argi-gune txikien bitartez.

Ceux qui, comme nous, habitent près de la Méditerranée connaissent toutes les nuances de la lumière.  
C'est pourquoi à la nuit tombée, nous la transformons en petits espaces de lumière.

Os que vivimos à beira do Mediterráneo conhecemos todos los matices da luz.  
Por isso ao chegar a noite transformá-mos-la em pequenos espaços do dia.

Noi che viviamo vicino al Mediterraneo conosciamo tutte le tonalità e le sfumature della luce.  
Per questo quando cala la notte, la trasformiamo in piccoli spazi del giorno.

Quem vive perto do Mediterráneo conhece todas as nuances da luz.  
Por isso, quando chega a noite, transformamo-la em pequenos espaços de dia.

Lluís Porqueras

ES que vivim prop de la Mediterrània,  
coneixem tots els matisos de la llum.  
Per això en arribar la nit la  
transformem en petits espais de dia.

Lluís Porqueras

EDITOR / PUBLISHER  
JOANA BOVER

DISSENY GRÀFIC / GRAPHIC DESIGNER  
MIQUEL LLACH

FOTOGRAFIES / PHOTOGRAPHERS  
JORDI SOLÉ / J.E. ESTUDI DISSENY  
BEFREE STUDIO

AGRAÏMENTS / SPECIAL THANKS  
Mireia Sust / Hoteles Vincci  
Hotel Nord 1901 / Girona  
Danone / Barcelona  
Cinta F. Camps / Hostal Empúries / L'Escala  
Fonda Europa / Granollers  
Hotel Villa Emilia / Barcelona  
Restaurant Pasarela / La Roca Village  
Coquinaria / Santa Agnès de Malanyanes  
Farmàcia Mercè Carbonell / Cardedeu  
Hotel SB Europa / Alado Decoració

DIPÒSIT LEGAL: 18084-09

MARÇ 2015



BOVER

B A R C E L O N A

CATÁLOGO GENERAL / *GENERAL CATALOGUE*



**MADE IN BARCELONA**

**EXTERIOR**  
**OUTDOOR**



- ALBA**, 12
- AMPHORA**, 14
- FORA**, 20
- GAROTA**, 34
- MAXI**, 46
- LINEANA**, 50
- SYRA**, 54

**CONTEMPORÁNEO**  
**CONTEMPORARY**

**APLIQUE**  
**WALL LAMP**



- ALBA**, 62
- BCN**, 66
- CLUB**, 70
- FLEXO**, 72
- FLEXO LEXA**, 74
- KLAR**, 76
- LEA**, 78
- LIBAN**, 82
- NÓN LÁ**, 84
- PLANA**, 88
- SPOCK**, 92
- TIMEA**, 94
- TRIA**, 96
- TWALL**, 100

**SUSPENSIÓN**  
**PENDANT LAMP**



- CALA**, 102
- CLUB**, 106
- ELEA**, 108
- ELIPSE**, 116
- HARDY**, 120
- INARI**, 124
- NÓN LÁ**, 128
- SLEND**, 134
- SYRA INDOOR**, 142
- TIBETA**, 146
- TWINS**, 150

**PLAFÓN**  
**CEILING**



- CALA**, 154
- ELEA**, 158

**MESA**  
**TABLE LAMP**



- CLUB**, 162
- INARI**, 164
- MUF**, 166
- NÓN LÁ**, 168
- ONNE**, 170
- SPOCK**, 174

**PIE**  
**FLOOR**



- CLUB**, 178
- INARI**, 180
- SPOCK**, 182
- PEANA**, 184

## CINTA RIBBON

### APLIQUE WALL LAMP

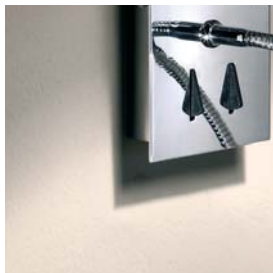

**BASIK**, 190  
**CARLOTA**, 192  
**LEXA**, 196  
**LEXA - FL**, 198  
**MEI OVAL**, 200  
**SILANTRA**, 204  
**WALL STREET - FL**, 210  
**WALL STREET**, 212  
**WALL STREET T5**, 214

### SUSPENSIÓN PENDANT LAMP



**CORNELIA**, 216  
**DANONA**, 222  
**LÁMPARA XVIII**, 224  
**LUA**, 228  
**MAR**, 230  
**MARIETTA**, 232  
**MAXI**, 236  
**MEI**, 240  
**MEI OVAL**, 248  
**MOS**, 250  
**OLIVER**, 254  
**SIAM**, 258  
**SILANTRA**, 262  
**TAU**, 266  
**TEKNO**, 268  
**URBAN**, 272

### PLAFÓN CEILING



**KUADRAT**, 276  
**OLIVER**, 278  
**PLAFONET**, 280  
**RONDO**, 284  
**SIAM**, 286  
**URBAN**, 296

### MESA TABLE LAMP



**CARLOTA**, 300  
**DANONA**, 302  
**EMA**, 304  
**GIBSI**, 306  
**MANI**, 308  
**MEI OVAL**, 310  
**TAU**, 312  
**TAU MADERA**, 314

### PIE FLOOR



**CARLOTA**, 316  
**DANONA**, 318  
**EMA**, 320  
**MAXI**, 322  
**MEI OVAL**, 324  
**TAU**, 326  
**TAU MADERA**, 328

### ARTESANAL HAND-CRAFTED



**AVANI**, 332  
**FERRARA**, 334



**CHRISTOPHE MATHIEU**



**SERGI & ÒSCAR DEVESA**



**JOANA BOVER**



**LUIS VIÑAS**



**LLUÍS PORQUERAS**



**RUBÉN SALDAÑA**



**JORDI LLOPIS**



**CARLES RIART**



**GONZALO MILÀ**



**ALEX FERNÁNDEZ CAMPS**



**JORGE PENSI DESIGN STUDIO**



# EXTERIOR *OUTDOOR*



# ALBA

DESIGN: RUBÉN SALDAÑA 2014

## ALBA - 60

APLIQUE EXTERIOR / OUTDOOR WALL LAMP

IP-55 230V-50Hz



11,5 W LED Led 28 x 0,41 W = 11,5 W Osram  
Lumens 1060 lm  
Valor cromático / CRI 85  
Grados Kelvin / Degrees Kelvin 3000°

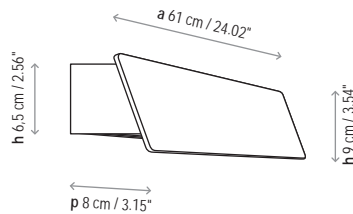

## EXTERIOR / OUTDOOR

2270100614 LED EXTERIORES / MARRÓN GRAFITO  
ESTRUCTURA INOXIDABLE - FRONTAL DE ALUMINIO  
LED OUTDOOR / GRAPHITE BROWN  
STAINLESS STEEL STRUCTURE - ALUMINUM FRONT

**OPCIONAL (CONSULTAR) / OPTIONAL (CONSULT)**  
Interruptor solo para productos de interior que no requieran IP.  
Available switch option only for indoor products not requiring IP.

## ALBA - 90

APLIQUE EXTERIOR / OUTDOOR WALL LAMP

IP-55 230V-50Hz



17 W LED Led 42 x 0,41 W = 17 W Osram  
Lumens 1600 lm  
Valor cromático / CRI 85  
Grados Kelvin / Degrees Kelvin 3000°

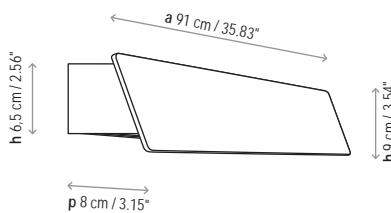

2270200614 LED EXTERIORES / MARRÓN GRAFITO  
ESTRUCTURA INOXIDABLE - FRONTAL DE ALUMINIO  
LED OUTDOOR / GRAPHITE BROWN  
STAINLESS STEEL STRUCTURE - ALUMINUM FRONT

**OPCIONAL (CONSULTAR) / OPTIONAL (CONSULT)**  
Interruptor solo para productos de interior que no requieran IP.  
Available switch option only for indoor products not requiring IP.

## FAMILIA / FAMILY



## ACABADOS / FINISHING

MARRÓN GRAFITO  
GRAPHITE BROWN

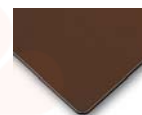







# AMPHORA

DESIGN: ALEX FERNÁNDEZ CAMPS / GONZALO MILÀ 2013

EXTERIOR / OUTDOOR

## AMPHORA - 01

PIE EXTERIOR / OUTDOOR FLOOR

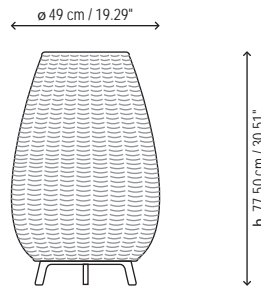

0133003 MARRÓN / BROWN GRAPHITE

Pantalla 49 x 69,5 cm - Fibra Sintética Polietileno  
(Temperatura de uso: -70°C a +70°C)  
Lampshade 19.29" x 27.36" - Synthetic Polyethylene Fiber  
(Operating temperature: -70°C to +70°C)

P-741 BEIGE CLARO / LIGHT BEIGE  
P-742 MARRÓN / BROWN

## AMPHORA - 02

PIE EXTERIOR / OUTDOOR FLOOR

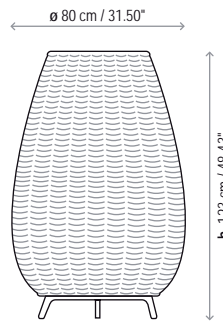

0233003 MARRÓN / BROWN GRAPHITE

Pantalla 80 x 113,5 cm - Fibra Sintética Polietileno  
(Temperatura de uso: -70°C a +70°C)  
Lampshade 31.50" x 44.69" - Synthetic Polyethylene Fiber  
(Operating temperature: -70°C to +70°C)

P-744 BEIGE CLARO / LIGHT BEIGE  
P-745 MARRÓN / BROWN

## AMPHORA - 03

PIE EXTERIOR / OUTDOOR FLOOR

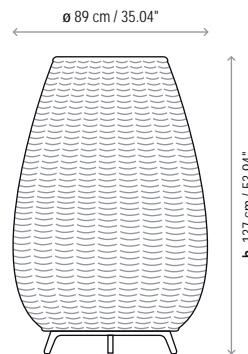

0333003 MARRÓN / BROWN GRAPHITE

Pantalla 89 x 127 cm - Fibra Sintética Polietileno  
(Temperatura de uso: -70°C a +70°C)  
Lampshade 35.04" x 50" - Synthetic Polyethylene Fiber  
(Operating temperature: -70°C to +70°C)

P-747 BEIGE CLARO / LIGHT BEIGE  
P-748 MARRÓN / BROWN



### ACABADOS / FINISHING

MARRÓN  
BROWN GRAPHITE

BEIGE CLARO  
LIGHT BEIGE

MARRÓN  
BROWN

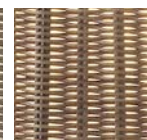
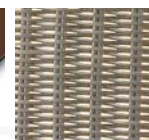









Restaurant Pasarela / La Roca Village









# FORA

DESIGN: ALEX FERNÁNDEZ CAMPS / GONZALO MILÀ 2010

EXTERIOR / OUTDOOR

## FORA - S

SUSPENSIÓN EXTERIOR / OUTDOOR PENDANT LAMP

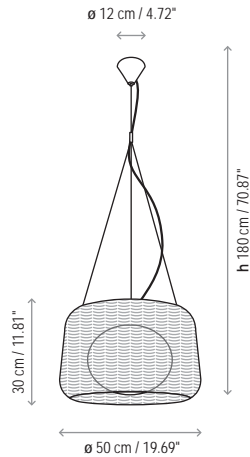

4130301 BLANCO ROTO / NATURAL WHITE  
P-695 C BEIGE CLARO / LIGHT BEIGE

4130303 MARRÓN / BROWN GRAPHITE  
P-696 C MARRÓN / BROWN

Pantalla 50 x 30 cm - Fibra Sintética Polietileno  
(Temperatura de uso: -70°C a +70°C)  
Lampshade 19.69" x 11.81" - Synthetic Polyethylene Fiber  
(Operating temperature: -70°C to +70°C)

La fuente de luz está protegida por un globo de polietileno de media densidad y protección UV (Temperatura de uso: -40°C a +70°C)  
Light source is protected by polyethylene globe of medium density and UV protection (Operating temperature: -40°C to +70°C).

## FORA - 90

SUSPENSIÓN EXTERIOR / OUTDOOR PENDANT LAMP

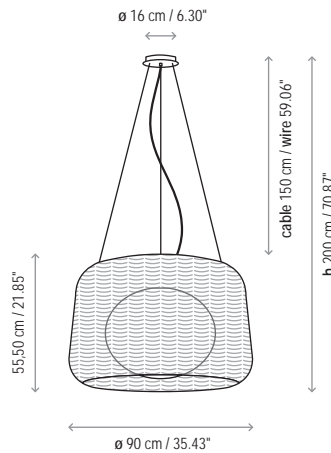

4030301 BLANCO ROTO / NATURAL WHITE  
P-707 C BEIGE CLARO / LIGHT BEIGE

4030303 MARRÓN / BROWN GRAPHITE  
P-708 C MARRÓN / BROWN

Pantalla 90 x 55,50 cm - Fibra Sintética Polietileno  
(Temperatura de uso: -70°C a +70°C)  
Lampshade 35.43" x 21.85" - Synthetic Polyethylene Fiber  
(Operating temperature: -70°C to +70°C)

La fuente de luz está protegida por un globo de polietileno de media densidad y protección UV (Temperatura de uso: -40°C a +70°C)  
Light source is protected by polyethylene globe of medium density and UV protection (Operating temperature: -40°C to +70°C).



## FAMILIA / FAMILY

pàg 20 20 26 26 32 32

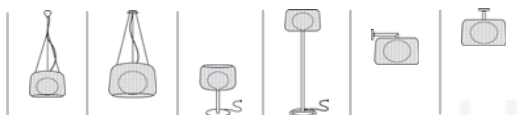

## ACABADOS / FINISHING

BLANCO ROTO  
NATURAL WHITE

MARRÓN  
BROWN GRAPHITE

BEIGE CLARO  
LIGHT BEIGE

MARRÓN  
BROWN

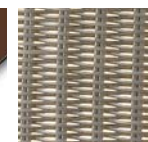

















# FORA

DESIGN: ALEX FERNÁNDEZ CAMPS / GONZALO MILÀ 2010

## FORA - MESA

MESA EXTERIOR / OUTDOOR TABLE LAMP

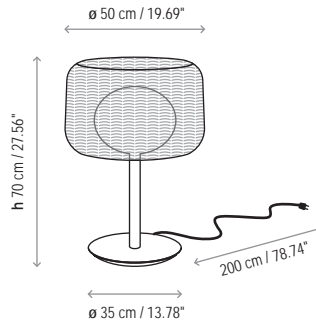

## EXTERIOR / OUTDOOR

2230301 BLANCO ROTO / NATURAL WHITE  
P-695 BEIGE CLARO / LIGHT BEIGE

2230303 MARRÓN / BROWN GRAPHITE  
P-696 MARRÓN / BROWN

Pantalla 50 x 30 cm - Fibra Sintética Polietileno  
(Temperatura de uso: -70°C a +70°C)  
*Lampshade 19.69" x 11.81" - Synthetic Polyethylene Fiber  
(Operating temperature: -70°C to +70°C)*

La fuente de luz está protegida por un globo de polietileno de media densidad y protección UV (Temperatura de uso: -40°C a +70°C)  
*Light source is protected by polyethylene globe of medium density and UV protection (Operating temperature: -40°C to +70°C).*

## FORA - PIE

PIE EXTERIOR / OUTDOOR FLOOR

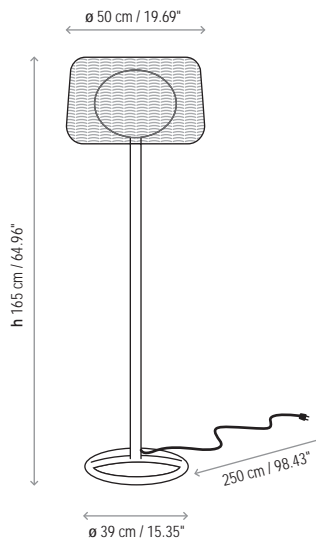

3030301 BLANCO ROTO / NATURAL WHITE  
P-695 BEIGE CLARO / LIGHT BEIGE

3030303 MARRÓN / BROWN GRAPHITE  
P-696 MARRÓN / BROWN

Pantalla 50 x 30 cm - Fibra Sintética Polietileno  
(Temperatura de uso: -70°C a +70°C)  
*Lampshade 19.69" x 11.81" - Synthetic Polyethylene Fiber  
(Operating temperature: -70°C to +70°C)*

La fuente de luz está protegida por un globo de polietileno de media densidad y protección UV (Temperatura de uso: -40°C a +70°C)  
*Light source is protected by polyethylene globe of medium density and UV protection (Operating temperature: -40°C to +70°C).*

La base de fundición de hierro destaca por su forma radial que facilita el paso de la luz sobre el césped, evitando su deterioro  
*The cast iron base is distinguished by a radial base whose tubular design improves durability and allows light to reach the grass.*

Consulte las opciones de anclaje al suelo  
*Consult for floor fastening options.*



## FAMILIA / FAMILY

pàg 20 20 26 26 32 32



## ACABADOS / FINISHING

BLANCO ROTO  
NATURAL WHITE

MARRÓN  
BROWN GRAPHITE

BEIGE CLARO  
LIGHT BEIGE

MARRÓN  
BROWN

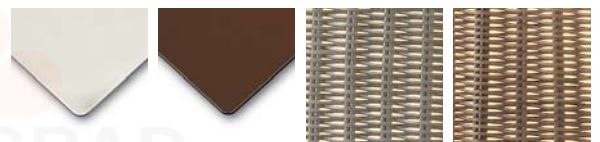









Hotel Nord 1901 / Girona











# FORA

DESIGN: ALEX FERNÁNDEZ CAMPS / GONZALO MILÀ 2010

EXTERIOR / OUTDOOR

## FORA - APLIQUE

APLIQUE EXTERIOR / OUTDOOR WALL LAMP

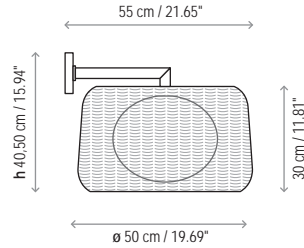

1130301 BLANCO ROTO / NATURAL WHITE  
P-695 C BEIGE CLARO / LIGHT BEIGE

1130303 MARRÓN / BROWN GRAPHITE  
P-696 C MARRÓN / BROWN

Pantalla 50 x 30 cm - Fibra Sintética Polietileno  
(Temperatura de uso: -70°C a +70°C)  
Lampshade 19.69" x 11.81" - Synthetic Polyethylene Fiber  
(Operating temperature: -70°C to +70°C)

La fuente de luz está protegida por un globo de polietileno de media densidad y protección UV (Temperatura de uso: -40°C a +70°C)  
Light source is protected by polyethylene globe of medium density and UV protection (Operating temperature: -40°C to +70°C).

\* Producción bajo pedido. Plazo de entrega: 4 semanas  
\* Production on demand. Delivery time: 4 week

## FORA - PLAFÓN

PLAFÓN EXTERIOR / OUTDOOR CEILING

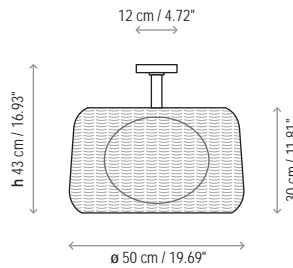

5130301 BLANCO ROTO / NATURAL WHITE  
P-695 C BEIGE CLARO / LIGHT BEIGE

5130303 MARRÓN / BROWN GRAPHITE  
P-696 C MARRÓN / BROWN

Pantalla 50 x 30 cm - Fibra Sintética Polietileno  
(Temperatura de uso: -70°C a +70°C)  
Lampshade 19.69" x 11.81" - Synthetic Polyethylene Fiber  
(Operating temperature: -70°C to +70°C)

La fuente de luz está protegida por un globo de polietileno de media densidad y protección UV (Temperatura de uso: -40°C a +70°C)  
Light source is protected by polyethylene globe of medium density and UV protection (Operating temperature: -40°C to +70°C).

\* Producción bajo pedido. Plazo de entrega: 4 semanas  
\* Production on demand. Delivery time: 4 week

## FAMILIA / FAMILY

pàg 20 20 26 26 32 32



## ACABADOS / FINISHING

BLANCO ROTO / NATURAL WHITE    MARRÓN / BROWN GRAPHITE    BEIGE CLARO / LIGHT BEIGE    MARRÓN / BROWN

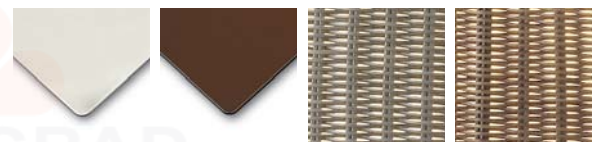



# GAROTA

DESIGN: ALEX FERNÁNDEZ CAMPS / GONZALO MILÀ 2015

EXTERIOR / OUTDOOR

## GAROTA - PF 01

PLAFÓN EXTERIOR / OUTDOOR CEILING



9 W LED | Led 9 W Osram  
Lumens 960 lm  
Valor cromático / CRI/85  
Grados Kelvin / Degrees Kelvin 2700°

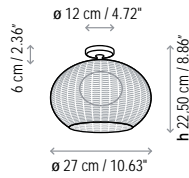

3350110201 BLANCO ROTO / NATURAL WHITE  
3350110203 MARRÓN / BROWN GRAPHITE

P-803 BLANCO MARFIL / IVORY WHITE  
P-804 MARRÓN / BROWN

Estructura pantalla y florón de aluminio  
Aluminium shade structure and canopy

## GAROTA - PF 02

PLAFÓN EXTERIOR / OUTDOOR CEILING



2 x 22 W E-27

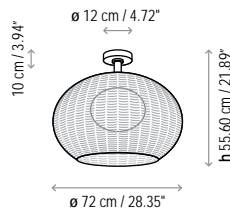

3350210001 BLANCO ROTO / NATURAL WHITE  
3350210003 MARRÓN / BROWN GRAPHITE

P-801 BLANCO MARFIL / IVORY WHITE  
P-802 MARRÓN / BROWN

Estructura pantalla y florón de aluminio  
Aluminium shade structure and canopy

## GAROTA - S 01

SUSPENSIÓN EXTERIOR / OUTDOOR PENDANT LAMP



9 W LED | Led 9 W Osram  
Lumens 960 lm  
Valor cromático / CRI/85  
Grados Kelvin / Degrees Kelvin 2700°

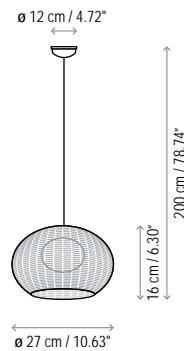

3350120101 BLANCO ROTO / NATURAL WHITE  
3350120103 MARRÓN / BROWN GRAPHITE

P-803 BLANCO MARFIL / IVORY WHITE  
P-804 MARRÓN / BROWN

Estructura pantalla y florón de aluminio.  
Aluminium shade frame and canopy

## GAROTA - S 02

SUSPENSIÓN EXTERIOR / OUTDOOR PENDANT LAMP



2 x 22 W E-27

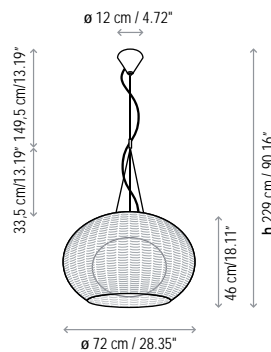

3350220201 BLANCO ROTO / NATURAL WHITE  
3350220203 MARRÓN / BROWN GRAPHITE

P-801 BLANCO MARFIL / IVORY WHITE  
P-802 MARRÓN / BROWN

Estructura pantalla y florón de aluminio.  
Aluminium shade frame and canopy

### FAMILIA / FAMILY

pàg 34 34 34 34 40 40 40 40 40

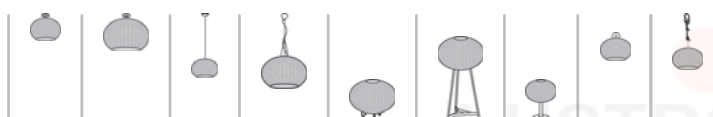

### ACABADOS / FINISHING

MARRÓN / BROWN GRAPHITE | BLANCO ROTO / NATURAL WHITE | BLANCO NATURAL / NATURAL WHITE | MARRÓN / BROWN

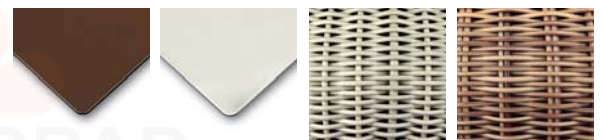













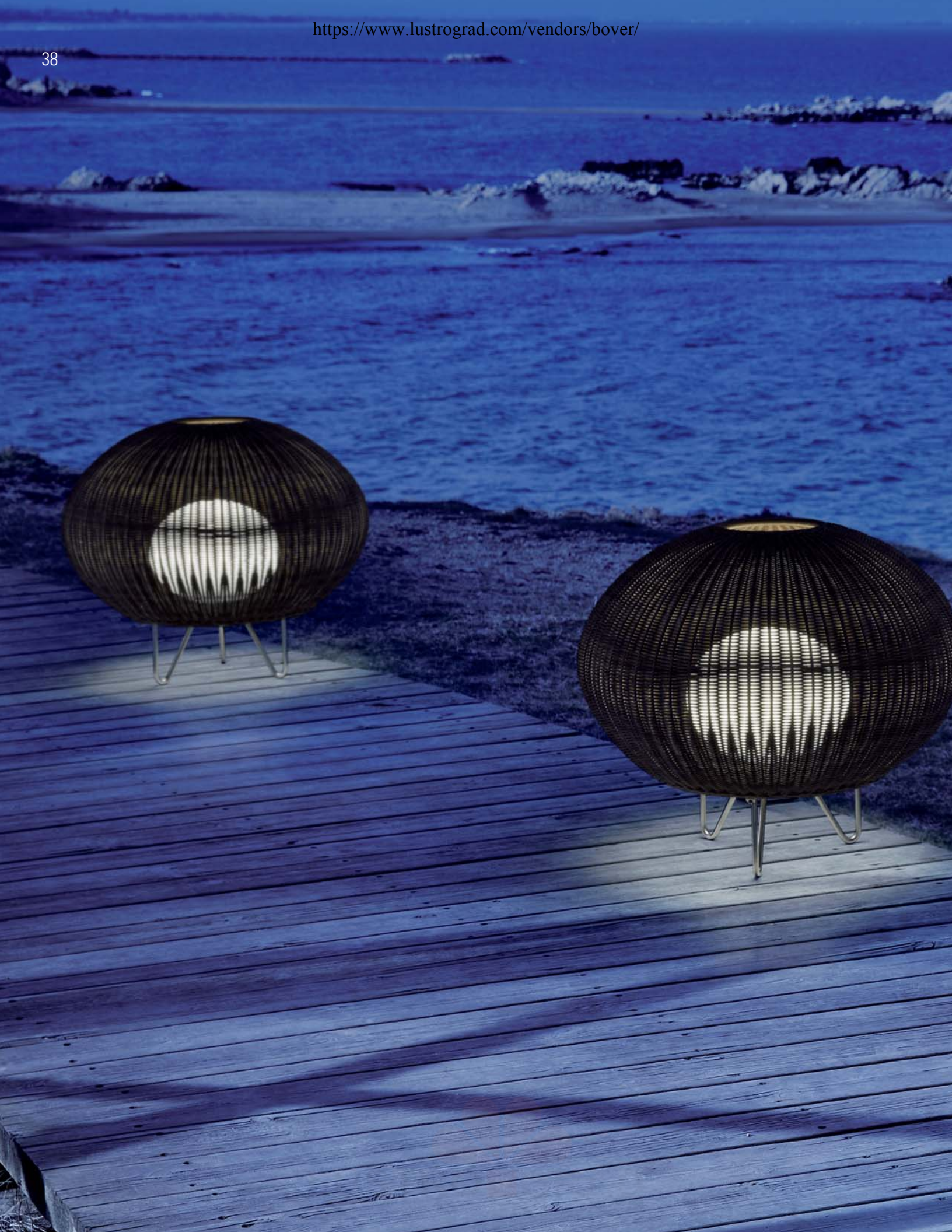







# GAROTA

DESIGN: ALEX FERNÁNDEZ CAMPS / GONZALO MILÀ 2015

## GAROTA - P 01

PIE EXTERIOR / OUTDOOR FLOOR

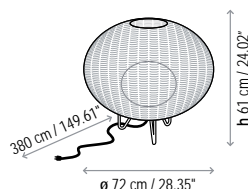

3350130088 ACERO INOXIDABLE 316 / STAINLESS STEEL 316

P-801 BLANCO MARFIL / IVORY WHITE  
P-802 MARRÓN / BROWN

Consulte las opciones de anclaje al suelo  
*Consult for floor fastening options*

## GAROTA - P 02

PIE EXTERIOR / OUTDOOR FLOOR

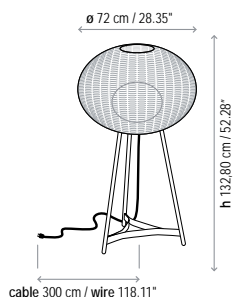

3350230001 BLANCO ROTO / NATURAL WHITE  
3350230003 MARRÓN / BROWN GRAPHITE

P-801 BLANCO MARFIL / IVORY WHITE  
P-802 MARRÓN / BROWN

La estructura es de inox. + proceso cataforesis y pintura para exterior.  
*Stainless steel structure, cataphoresis treatment and outdoor paint.*

Consulte las opciones de anclaje al suelo.  
*Consult for floor fastening options.*

Altura no modificable / *Height non customizable.*

## GAROTA - MINI

MESITA EXTERIOR / OUTDOOR MINI TABLE LAMP

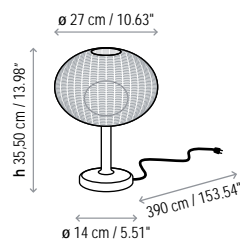

3350630201 BLANCO ROTO / NATURAL WHITE  
3350630203 MARRÓN / BROWN GRAPHITE

P-803 BLANCO MARFIL / IVORY WHITE  
P-804 MARRÓN / BROWN

Estructura pantalla de aluminio / *Aluminium shade frame*

## GAROTA - A 01

APLIQUE EXTERIOR / OUTDOOR WALL LAMP

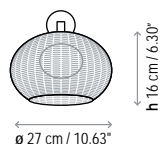

3350730201 BLANCO ROTO / NATURAL WHITE  
3350730203 MARRÓN / BROWN GRAPHITE

P-803 BLANCO MARFIL / IVORY WHITE  
P-804 MARRÓN / BROWN

Estructura pantalla y florón de aluminio / *Aluminium shade structure and canopy*

## GAROTA - HANG

PLAFÓN EXTERIOR / OUTDOOR CEILING

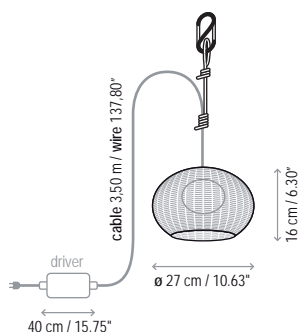

3350720101 BLANCO ROTO / NATURAL WHITE  
3350720103 MARRÓN / BROWN GRAPHITE

P-803 BLANCO MARFIL / IVORY WHITE  
P-804 MARRÓN / BROWN

Esta luminaria no contiene interruptor. Transformador instalado en el cable.  
*This luminaire does not include a switch. The driver is installed on the wire.*

Longitud total del cable: 5 metros

*Total wire length: 196.85 inches.*

Estructura pantalla de aluminio - gancho de inox.  
*Aluminium shade frame - stainless steel hook*

### FAMILIA / FAMILY

pàg 34 34 34 34 40 40 40 40 40

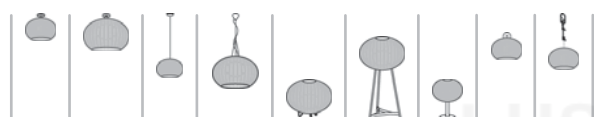

### ACABADOS / FINISHING

ACERO INOXIDABLE / STAINLESS STEEL    MARRÓN / BROWN GRAPHITE    BLANCO ROTO / NATURAL WHITE    BLANCO NATURAL / NATURAL WHITE    MARRÓN / BROWN







Hostal Empúries / L'Escala











# MAXI

DESIGN: JOANA BOVER 2004

## MAXI - P

PIE EXTERIOR / OUTDOOR FLOOR

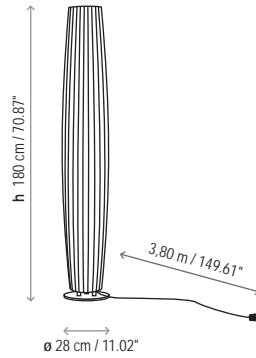
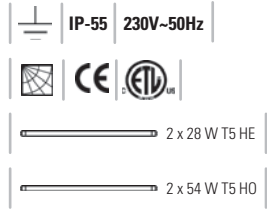

EXTERIOR / OUTDOOR

3229500 BLANCO / WHITE

Inclusión de tubos fluorescentes (2x28W) ya instalados en el interior de la luminaria.  
Supply fluorescent tubes (2x28W) already installed inside the luminaire.

La fuente de luz esta protegida por una pantalla de Polietileno (Temperatura de uso: -40°C a +70°C)  
Light source is protected by a Polyethylene shade (Operating temperature: -40°C to +70°C)

### Fijación a suelo:

La lámpara de pie puede fijarse al suelo retirando los tapones de goma que se encuentran en la base.

### Fijación a suelo con salida de cable empotrado:

En este caso el cable utilizado debe ser de goma o superior tipo HO5RN-F de entre 6 y 8 mm de diámetro.

### Fixing on the floor:

The floor lamp can be fixed by removing the rubber stoppers placed on the foot base.

### Fixing on the surface with built-in wire:

In this case, wire should be made out of rubber type HO5RN or superior, with a diameter between 6 and 8 mm.

## MAXI - S

SUSPENSIÓN EXTERIOR  
OUTDOOR PENDANT LAMP

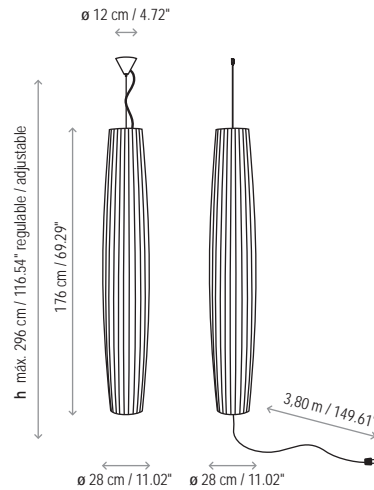
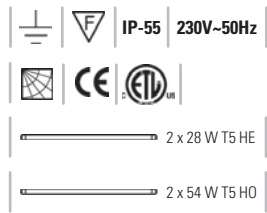

4429500TOP INSTALACIÓN SUPERIOR  
ELECTRICAL UPPER INSTALLATION

4429500INF INSTALACIÓN INFERIOR  
ELECTRICAL BOTTOM INSTALLATION

Inclusión de tubos fluorescentes (2x28W) ya instalados en el interior de la luminaria.  
Supply fluorescent tubes (2x28W) already installed inside the luminaire.

La fuente de luz esta protegida por una pantalla de Polietileno (Temperatura de uso: -40°C a +70°C)  
Light source is protected by a Polyethylene shade (Operating temperature: -40°C to +70°C)

Altura regulable cable tensor con seguro / Adjustable tensor wire  
Floron acabado blanco / White canopy finished  
(Solo para instalacion superior / Only for Upper installation)

## FAMILIA / FAMILY

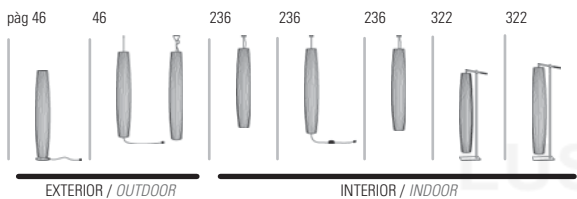

## ACABADOS / FINISHING

BLANCO  
WHITE









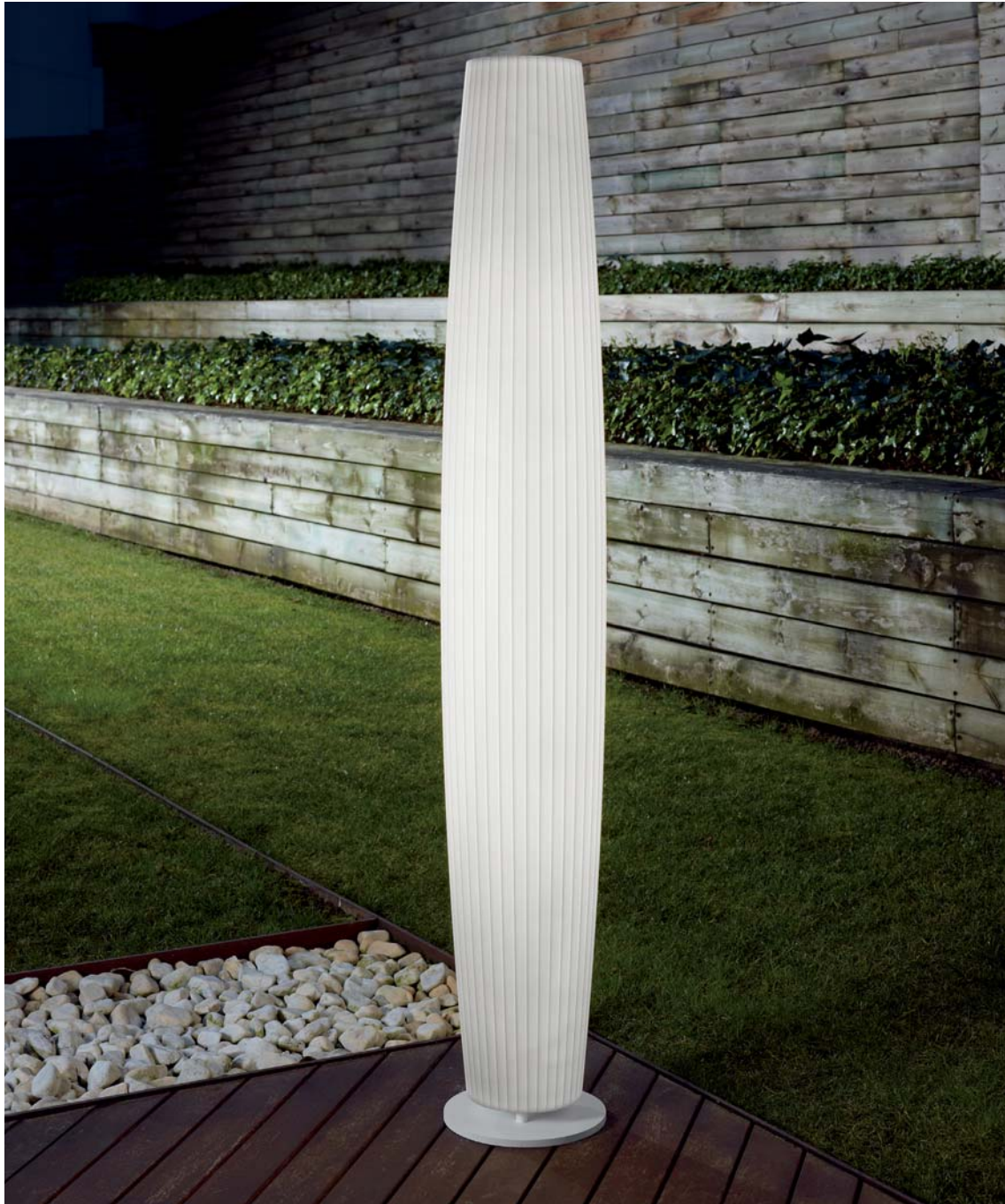







# LINEANA

DESIGN: CHRISTOPHE MATHIEU 2010

## LINEANA - H

APLIQUE EXTERIOR / OUTDOOR WALL LAMP

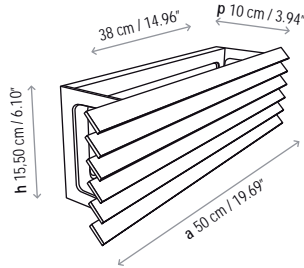
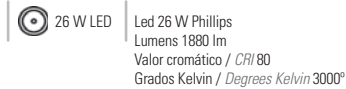

## EXTERIOR / OUTDOOR

1121208H GRIS GRAFITO (LED G9) / GRAPHITE GREY (LED G9)  
1121203H MARRÓN GRAFITO (LED G9) / BROWN GRAPHITE (LED G9)

1121208LH GRIS GRAFITO (LED) / GRAPHITE GREY (LED)  
1121203LH MARRÓN GRAFITO (LED) / BROWN GRAPHITE (LED)

Caja soporte: 38 x 15 cm / Surface back box: 14.96" x 5.91"

## LINEANA - V

APLIQUE EXTERIOR / OUTDOOR WALL LAMP

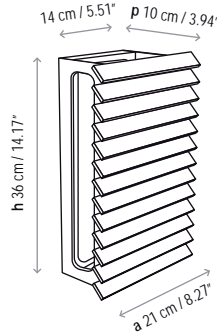
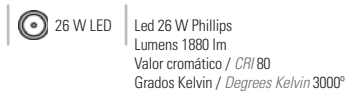

1121208V GRIS GRAFITO (LED G9) / GRAPHITE GREY (LED G9)  
1121203V MARRÓN GRAFITO (LED G9) / BROWN GRAPHITE (LED G9)

1121208LV GRIS GRAFITO (LED) / GRAPHITE GREY (LED)  
1121203LV MARRÓN GRAFITO (LED) / BROWN GRAPHITE (LED)

Caja soporte: 38 x 15 cm / Surface back box: 14.96" x 5.91"

## LINEANA - IPÉ

APLIQUE EXTERIOR / OUTDOOR WALL LAMP

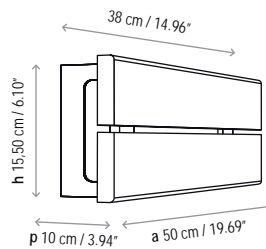
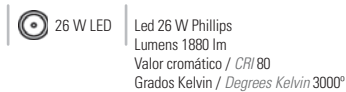

IPE21208H GRIS GRAFITO (LED G9) / GRAPHITE GREY (LED G9)  
IPE21203H MARRÓN GRAFITO (LED G9) / BROWN GRAPHITE (LED G9)

IPE21208LH GRIS GRAFITO (LED) / GRAPHITE GREY (LED)  
IPE21203LH MARRÓN GRAFITO (LED) / BROWN GRAPHITE (LED)

Caja soporte: 38 x 15 cm / Surface back box: 14.96" x 5.91"



## ACABADOS / FINISHING

MARRÓN BROWN GRAPHITE    GRIS GRAFITO GREY GRAPHITE    IPÉ IPE











# SYRA

DESIGN: ALEX FERNÁNDEZ CAMPS / GONZALO MILÀ 2014

EXTERIOR / OUTDOOR

## SYRA - 60 OUTDOOR

SUSPENSIÓN EXTERIOR / OUTDOOR PENDANT LAMP

IP-55 | 230V-50Hz



22 W LED | Led 66 x 0.33 W = 22 W Osram  
Lumens 2500 lm  
Valor cromático / CRI 85  
Grados Kelvin / Degrees Kelvin 2700°

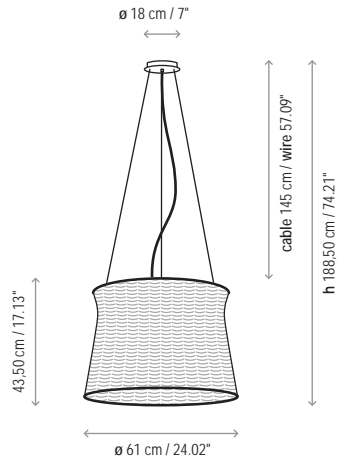

2640220158 BLANCO / WHITE  
2640220159 MARRÓN CHOCOLATE / CHOCOLATE BROWN

2640220358 REGULABLE SISTEMA DALI / BLANCO  
DALI DIMMING SYSTEM / WHITE

2640220359 REGULABLE SISTEMA DALI / MARRÓN CHOCOLATE  
DALI DIMMING SYSTEM / CHOCOLATE BROWN

## SYRA - 90 OUTDOOR

SUSPENSIÓN EXTERIOR / OUTDOOR PENDANT LAMP

**BIG FORMAT**

IP-55 | 230V-50Hz



28 W LED | Led 84 x 0.33 W = 28 W Osram  
Lumens 3200 lm  
Valor cromático / CRI 85  
Grados Kelvin / Degrees Kelvin 2700°

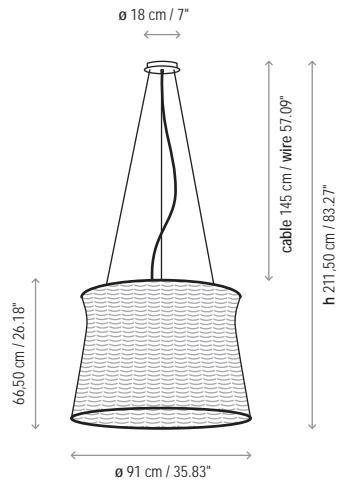

2640320158 BLANCO / WHITE  
2640320159 MARRÓN CHOCOLATE / CHOCOLATE BROWN

2640320358 REGULABLE SISTEMA DALI / BLANCO  
DALI DIMMING SYSTEM / WHITE

2640320359 REGULABLE SISTEMA DALI / MARRÓN CHOCOLATE  
DALI DIMMING SYSTEM / CHOCOLATE BROWN

### FAMILIA / FAMILY

pàg 54

54

142



**SYRA - 60 / 90  
OUTDOOR**



**SYRA - 45  
ONLY INDOOR  
APPLICATION**

### ACABADOS / FINISHING

BLANCO  
WHITE

MARRÓN CHOCOLATE  
CHOCOLATE BROWN

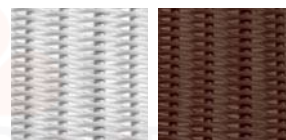





















# CONTEMPORÁNEO *CONTEMPORARY*





# ALBA

DESIGN: RUBÉN SALDAÑA 2014

## ALBA - 60

1 x 24 W T5 fluorescente  
 Reactancia electrónica

11,5 W LED
   
 Led 28 x 0,41 W = 11,5 W Osram  
 Lumens 1060 lm  
 Valor cromático / CRI 85  
 Grados Kelvin / Degrees Kelvin 2700°

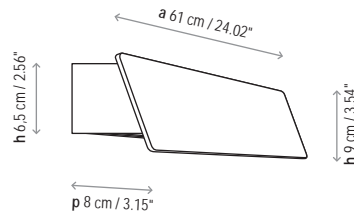

## CONTEMPORÁNEO / APLIQUE CONTEMPORARY / WALL LAMP

- 2270100263 BLANCO - MADERA ROBLE / WHITE - OAK WOOD
- 2270100264 ALUMINIO PULIDO / POLISHED ALUMINUM
- 2270100265 BLANCO / WHITE
  
- 2270100463 REGULABLE SISTEMA DALI / BLANCO - MADERA ROBLE  
DALI DIMMING SYSTEM / WHITE - OAK WOOD
- 2270100464 REGULABLE SISTEMA DALI / ALUMINIO PULIDO  
DALI DIMMING SYSTEM / POLISHED ALUMINUM
- 2270100465 REGULABLE SISTEMA DALI / BLANCO  
DALI DIMMING SYSTEM / WHITE
  
- 2270100663 LED INTERIORES / BLANCO - MADERA ROBLE  
LED INDOOR / WHITE - OAK WOOD
- 2270100664 LED INTERIORES / ALUMINIO PULIDO  
LED INDOOR / POLISHED ALUMINUM
- 2270100665 LED INTERIORES / BLANCO  
LED INDOOR / WHITE

## ALBA - 90

1 x 39 W T5 fluorescente  
 Reactancia electrónica

17 W LED
   
 Led 42 x 0,41 W = 17 W Osram  
 Lumens 1600 lm  
 Valor cromático / CRI 85  
 Grados Kelvin / Degrees Kelvin 2700°

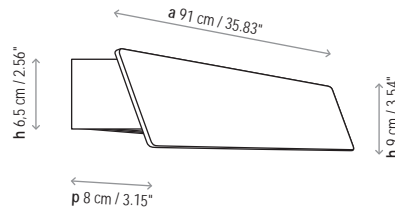

- 2270200263 BLANCO - MADERA ROBLE / WHITE - OAK WOOD
- 2270200264 ALUMINIO PULIDO / POLISHED ALUMINUM
- 2270200265 BLANCO / WHITE
  
- 2270200463 REGULABLE SISTEMA DALI / BLANCO - MADERA ROBLE  
DALI DIMMING SYSTEM / WHITE - OAK WOOD
- 2270200464 REGULABLE SISTEMA DALI / ALUMINIO PULIDO  
DALI DIMMING SYSTEM / POLISHED ALUMINUM
- 2270200465 REGULABLE SISTEMA DALI / BLANCO  
DALI DIMMING SYSTEM / WHITE
  
- 2270200663 LED INTERIORES / BLANCO - MADERA ROBLE  
LED INDOOR / WHITE - OAK WOOD
- 2270200664 LED INTERIORES / ALUMINIO PULIDO  
LED INDOOR / POLISHED ALUMINUM
- 2270200665 LED INTERIORES / BLANCO  
LED INDOOR / WHITE



**OPCIONAL (CONSULTAR)**  
Interruptor solo para productos de interior que no requieran IP.

**OPTIONAL (CONSULT)**  
Available switch option only for indoor products not requiring IP.

### FAMILIA / FAMILY

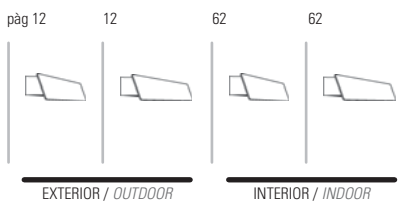

### ACABADOS / FINISHING













**CONTEMPORÁNEO / APLIQUE**  
**CONTEMPORARY / WALL LAMP**

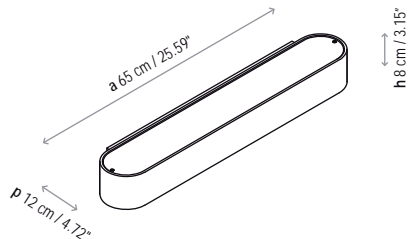

- 1526501 BLANCO LACADO BRILLANTE  
*WHITE BRILLIANT LACQUER*
- 1526523 NEGRO LACADO BRILLANTE  
*BLACK BRILLIANT LACQUER*
- 1526522 ROJO LACADO BRILLANTE  
*RED BRILLIANT LACQUER*
- D1526501 REGULABLE SISTEMA DALI / BLANCO LACADO BRILLANTE  
*DALI DIMMING SYSTEM / WHITE BRILLIANT LACQUER*
- D1526523 REGULABLE SISTEMA DALI / NEGRO LACADO BRILLANTE  
*DALI DIMMING SYSTEM / BLACK BRILLIANT LACQUER*
- D1526522 REGULABLE SISTEMA DALI / ROJO LACADO BRILLANTE  
*DALI DIMMING SYSTEM / RED BRILLIANT LACQUER*

Acabados: Poliuretano acabado lacado brillante  
*Finishing: Polyurethane/brilliant lacquer finish*

**ACABADOS / FINISHING**

LACADO ROJO  
*RED LACQUER*

LACADO BLANCO  
*WHITE LACQUER*

LACADO NEGRO  
*BLACK LACQUER*

















# CLUB

DESIGN: LUIS VIÑAS 2012

## CLUB - A

-   230V-50Hz
-  
-  1 x 46 W CLASSIC P ECO E-27
-  1 x 11 W E-27

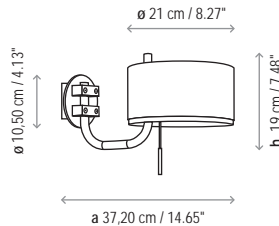

## CONTEMPORÁNEO / APLIQUE CONTEMPORARY / WALL LAMP

1532812 NEGRO MATE-NÍQUEL / MATTE BLACK-NICKEL

PANTALLA / LAMPSHADE







Pantalla aluminio negro  
Black aluminum shade

Interior PVC blanco B1 Flame Resistant  
White PVC interior B1 Flame Resistant

Incluye difusor superior de aluminio  
Included aluminum top diffuser

Brazo fijo / Fixed arm

## CLUB - A 2L

-   230V-50Hz
-  
-  2 x 46 W CLASSIC P ECO E-14
-  2 x 11 W E-14

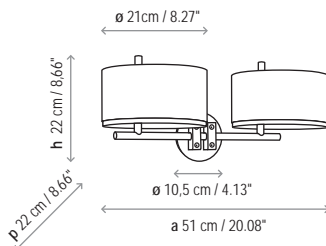

1232812 NEGRO MATE-NÍQUEL / MATTE BLACK-NICKEL

PANTALLA / LAMPSHADE

Pantalla aluminio negro  
Black aluminum shade

Interior PVC blanco B1 Flame Resistant  
White PVC interior B1 Flame Resistant

Incluye difusor superior de aluminio  
Included aluminum top diffuser



## FAMILIA / FAMILY

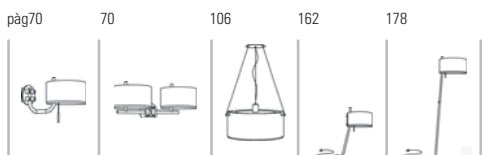

## ACABADOS / FINISHING

NEGRO MATE  
MATTE BLACK

NÍQUEL SATINADO  
SATIN NICKEL

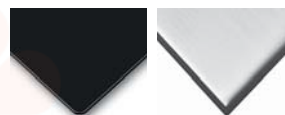





# FLEXO

DESIGN: JOANA BOVER 2006

## CONTEMPORÁNEO / APLIQUE CONTEMPORARY / WALL LAMP

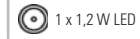

Led 1,2 W Phillips  
Óptica / Optics 45°  
Lumens: 85 lm  
Valor cromático / CRI 85  
Grados Kelvin / Degrees Kelvin 2900°

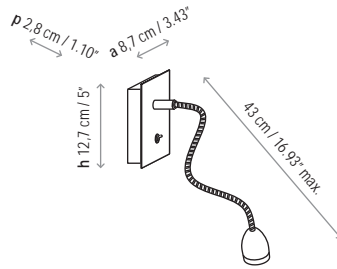

- FL25106 CROMO / CHROME
- FL25105 NÍQUEL SATINADO / SATIN NICKEL
- FL25160 NÍQUEL PIEL OSCURA / NICKEL DARK LEATHER
- FL25161 NÍQUEL PIEL CLARA / NICKEL CARAMEL LEATHER
- FL25116 CROMO CRISTAL ROJO / RED GLASS CHROME
- FL25117 CROMO CRISTAL NEGRO / BLACK GLASS CHROME

Flexo realizado en latón para mayor flexibilidad y garantía de rigidez.  
Cabezal de aluminio, interruptor de encendido en la base

*Flexo made in brass to ensure greater flexibility and rigidity.  
Aluminium hood and switch on back plate.*

Caja soporte 10,8 x 6,7 cm / Surface back box 4.25" x 2.64"



### ACABADOS / FINISHING

NÍQUEL SATINADO  
SATIN NICKEL

CROMO BRILLANTE  
BRILLIANT CHROME

PIEL OSCURA  
DARK LEATHER

PIEL CLARA  
CARAMEL LEATHER

CRISTAL ROJO  
RED GLASS

CRISTAL NEGRO  
BLACK GLASS

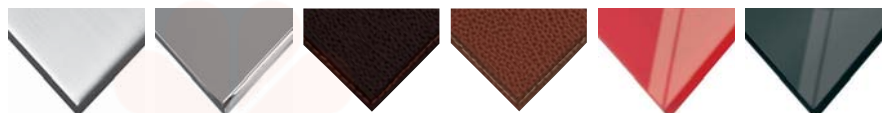





# FLEXO LEXA

DESIGN: CHRISTOPHE MATHIEU 2008

**CONTEMPORÁNEO / APLIQUE**  
**CONTEMPORARY / WALL LAMP**

230V-50Hz



1 x 1,2 W LED

Led 1,2 W Phillips  
Óptica / Optics 45°  
Lumens 85 lm  
Valor cromático / CRI 85  
Grados Kelvin / Degrees Kelvin 2900°

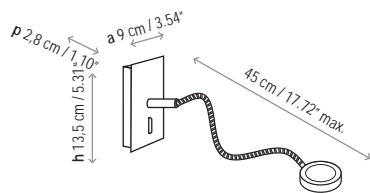

- FL20505 NÍQUEL SATINADO / SATIN NICKEL
- FL20506 CROMO BRILLANTE / BRILLIANT CHROME
- FL20508 CROMO-NEGRO / BLACK CHROME

Flexo realizado en latón para mayor flexibilidad y garantía de rigidez.  
Cabezal de inyección de Zamac, interruptores de encendido en la base.

*Flexo made in brass to ensure greater flexibility and rigidity, with Zamac injection. Hood and switch on back plate.*

Caja soporte 12 x 8 cm / Surface back box 4.72" x 3.15"



### ACABADOS / FINISHING

NÍQUEL SATINADO  
SATIN NICKEL

CROMO BRILLANTE  
BRILLIANT CHROME

CROMO NEGRO  
BLACK CHROME







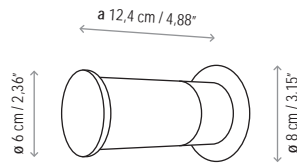

1125421 CROMO CRISTAL OPAL / CHROME OPAL GLASS



**ACABADOS / FINISHING**

CROMO BRILLANTE  
BRILLIANT CHROME





**LEA**

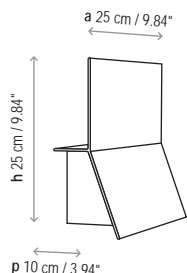

0021501 BLANCO / WHITE

Incluye difusor policarbonato / Polycarbonate diffuser included  
Estante superior hasta 4 kg / Upper shelf bears until 4 kg

Colores especiales: Por favor, indiquen el nº RAL.  
Cantidad mínima: 30 unidades.  
Special colors: RAL number to be indicated.  
Minimum quantity: 30 pieces.

**LEA - 01**

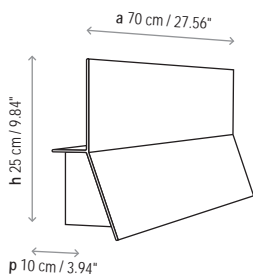
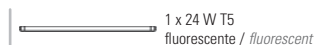

0121501 BLANCO  
WHITE

D0121501 REGULABLE SISTEMA DALI / BLANCO  
DALI DIMMING SYSTEM / WHITE

Incluye difusor policarbonato / Polycarbonate diffuser included  
Estante superior hasta 4 kg / Upper shelf bears until 4 kg

Colores especiales: Por favor, indiquen el nº RAL.  
Cantidad mínima: 30 unidades.  
Special colors: RAL number to be indicated.  
Minimum quantity: 30 pieces.

**LEA - 02**

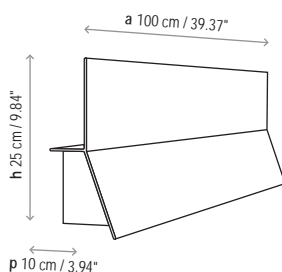
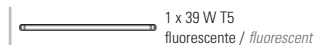

0221501 BLANCO  
WHITE

D0221501 REGULABLE SISTEMA DALI / BLANCO  
DALI DIMMING SYSTEM / WHITE

Incluye difusor policarbonato / Polycarbonate diffuser included  
Estante superior hasta 4 kg / Upper shelf bears until 4 kg

Colores especiales: Por favor, indiquen el nº RAL.  
Cantidad mínima: 30 unidades.  
Special colors: RAL number to be indicated.  
Minimum quantity: 30 pieces.

**LEA - 03**

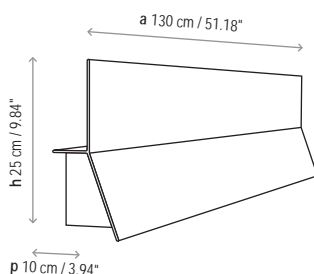
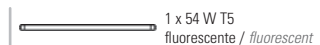

0321501 BLANCO  
WHITE

D0321501 REGULABLE SISTEMA DALI / BLANCO  
DALI DIMMING SYSTEM / WHITE

Incluye difusor policarbonato / Polycarbonate diffuser included  
Estante superior hasta 4 kg / Upper shelf bears until 4 kg

Colores especiales: Por favor, indiquen el nº RAL.  
Cantidad mínima: 30 unidades.  
Special colors: RAL number to be indicated.  
Minimum quantity: 30 pieces.



Interruptor opcional / Consultar.  
Optional switch / Consult

**ACABADOS / FINISHING**

BLANCO LEA  
LEA WHITE







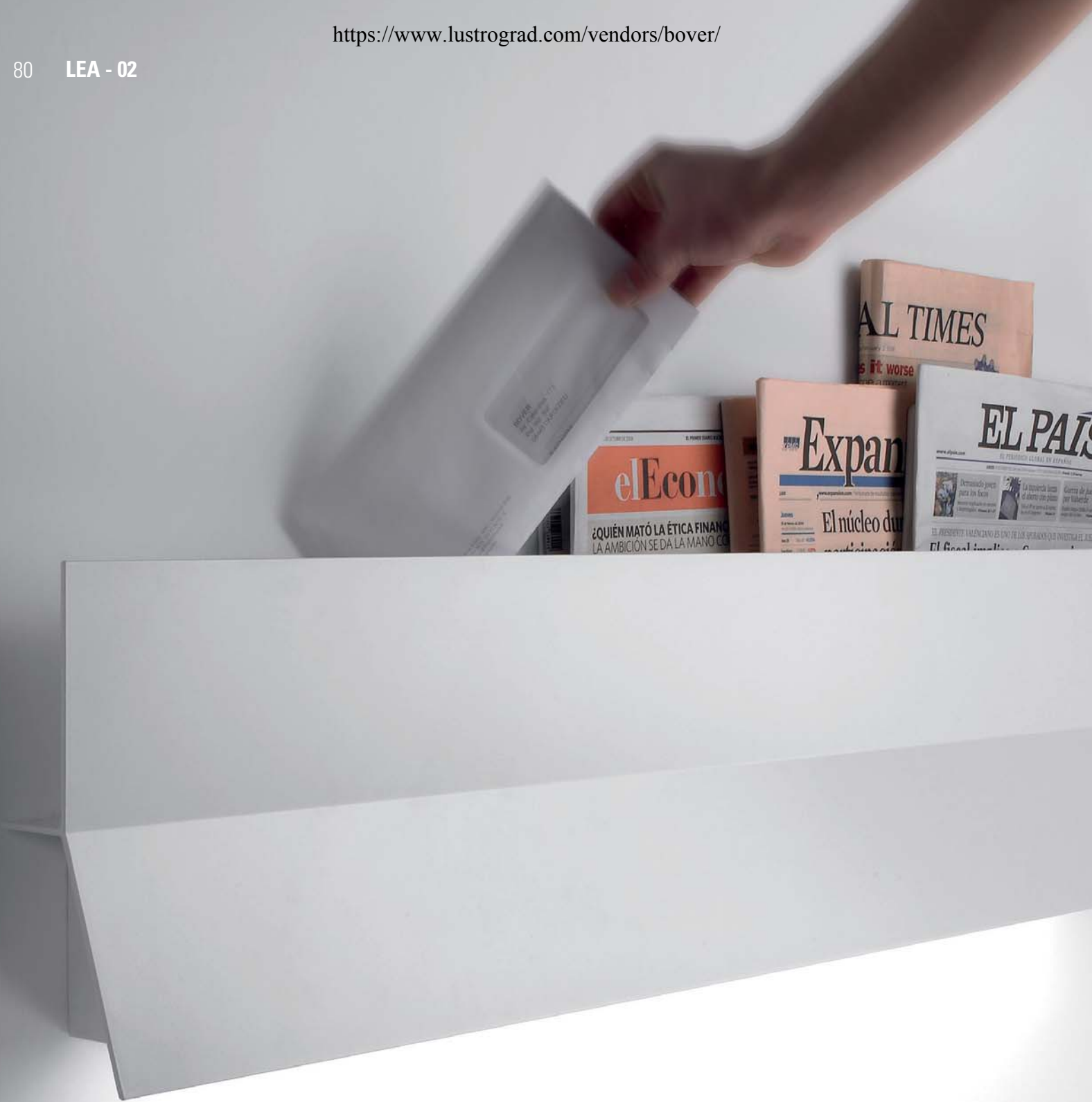





# LIBAN

DESIGN: LLUÍS PORQUERAS / CRISTIAN DIEZ 2003

**CONTEMPORÁNEO / APLIQUE**  
**CONTEMPORARY / WALL LAMP**



1 x 120 W R7S 118 mm

1 x 8 W LED R7S 118 mm

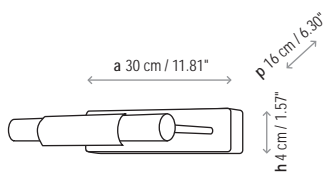

1118605 NÍQUEL SATINADO / SATIN NICKEL  
1118606 CROMO BRILLANTE / BRILLIANT CHROME

Caja soporte 28 x 4 cm / Surface back box 11.02" x 1.57"

### ACABADOS / FINISHING

NÍQUEL SATINADO  
SATIN NICKEL

CROMO BRILLANTE  
BRILLIANT CHROME

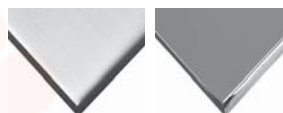



# NÓN LÁ

DESIGN: JORGE PENSI DESIGN STUDIO 2015

## NÓN LÁ - P 01



230V-50Hz



10,5 W LED

Led 35 x 0,3 = 10,5 W Osram  
Lumens 1200 lm  
Valor cromático / CRI 85  
Grados Kelvin / Degrees Kelvin 2700°

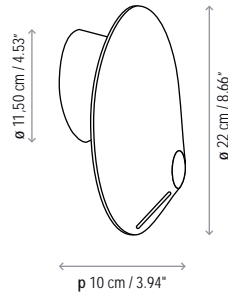

## CONTEMPORÁNEO / APLIQUE CONTEMPORARY / WALL LAMP

- 3320100601 BLANCO LACADO BRILLANTE / WHITE BRILLIANT LACQUER
- 3320100606 CROMO / CHROME
- 3320100623 NEGRO LACADO BRILLANTE / BLACK BRILLIANT LACQUER
- 3320100690 COBRE BRILLANTE / BRILLIANT COPPER

Regulación electrónica 1-10 V / 1-10 V Electronic dimming

- 3320101101 BLANCO LACADO BRILLANTE / WHITE BRILLIANT LACQUER
- 3320101106 CROMO / CHROME
- 3320101123 NEGRO LACADO BRILLANTE / BLACK BRILLIANT LACQUER
- 3320101190 COBRE BRILLANTE / BRILLIANT COPPER

## NÓN LÁ - P 02



230V-50Hz



10,5 W LED

Led 35 x 0,3 = 10,5 W Osram  
Lumens 1200 lm  
Valor cromático / CRI 85  
Grados Kelvin / Degrees Kelvin 2700°

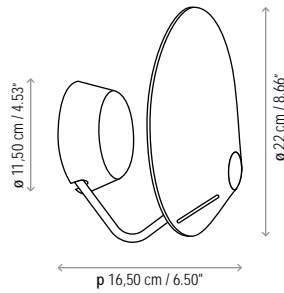

- 3320200601 BLANCO LACADO BRILLANTE / WHITE BRILLIANT LACQUER
- 3320200606 CROMO / CHROME
- 3320200623 NEGRO LACADO BRILLANTE / BLACK BRILLIANT LACQUER
- 3320200690 COBRE BRILLANTE / BRILLIANT COPPER

Regulación electrónica 1-10 V / 1-10 V Electronic dimming

- 3320201101 BLANCO LACADO BRILLANTE / WHITE BRILLIANT LACQUER
- 3320201106 CROMO / CHROME
- 3320201123 NEGRO LACADO BRILLANTE / BLACK BRILLIANT LACQUER
- 3320201190 COBRE BRILLANTE / BRILLIANT COPPER

### FAMILIA / FAMILY

pàg 84 84 128 132 132 132 168

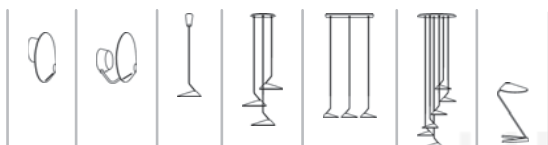

### ACABADOS / FINISHING

LACADO BLANCO  
WHITE LACQUER

LACADO NEGRO  
BLACK LACQUER

CROMO  
CHROME

COBRE BRILLO  
BRILLIANT COPPER













# PLANA

DESIGN: CHRISTOPHE MATHIEU 2004

**CONTEMPORÁNEO / APLIQUE**  
**CONTEMPORARY / WALL LAMP**

## PLANA - 01



1 x 80 W R7S 78 mm

1 x 6 W LED R7S 78 mm

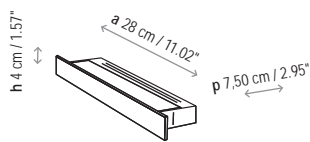

- 1119805 NÍQUEL SATINADO / SATIN NICKEL
- 1119806 CROMO BRILLANTE / BRILLIANT CHROME
- 1119820 NÍQUEL CRISTAL OPAL / NICKEL OPAL GLASS
- 1119821 CROMO CRISTAL OPAL / CHROME OPAL GLASS

## PLANA - 02



2 x 80 W R7S 78 mm

2 x 6 W LED R7S 78 mm

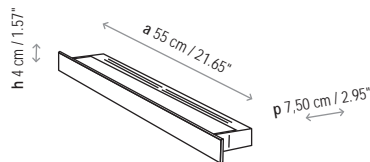

- 1219805 NÍQUEL SATINADO / SATIN NICKEL
- 1219806 CROMO BRILLANTE / BRILLIANT CHROME
- 1219820 NÍQUEL CRISTAL OPAL / NICKEL OPAL GLASS
- 1219821 CROMO CRISTAL OPAL / CHROME OPAL GLASS

## PLANA - T5



2 x 24 W T5 fluorescente  
 Reactancia electrónica  
 Fluorescent  
 Electronic ballast

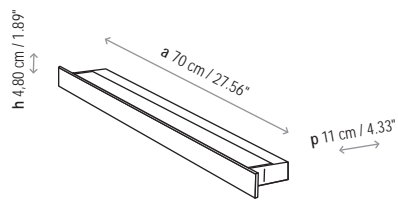

- T519805 NÍQUEL SATINADO / SATIN NICKEL
- T519806 CROMO BRILLANTE / BRILLIANT CHROME



### ACABADOS / FINISHING

- NÍQUEL SATINADO  
SATIN NICKEL
- CROMO BRILLANTE  
BRILLIANT CHROME

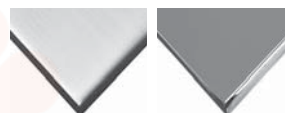









# SPOCK

DESIGN: CHRISTOPHE MATHIEU 2007

**CONTEMPORÁNEO / APLIQUE**  
*CONTEMPORARY / WALL LAMP*



4,8 W LED Led: 4 x 1.2 W = 4.8 W Phillips  
Lumens: 85 x 4 = 340 lm  
Valor cromático / CRI: 85  
Grados Kelvin / Degrees Kelvin: 2900°

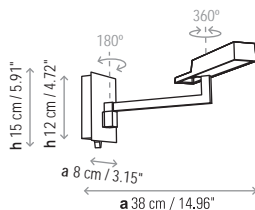

- 1110505L NÍQUEL / *NICKEL*
- 1110506L CROMO / *CHROME*
- 1110511L CROMO-BLANCO / *CHROME-WHITE*



## FAMILIA / FAMILY

pàg 92    174    174    182



## ACABADOS / FINISHING

NÍQUEL SATINADO    CROMO BRILLANTE    BLANCO  
*SATIN NICKEL    BRILLIANT CHROME    WHITE*

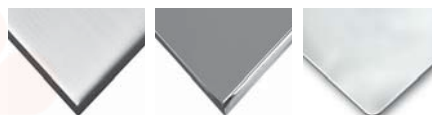



LONDON & NEW YORK  
APARTMENTS  
Апартаменты в Лондоне и Нью-Йорке  
Апартаменты в Лондоне и Нью-Йорке  
Апартаменты в Лондоне и Нью-Йорке



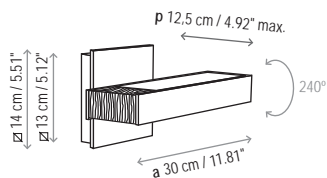

- 1025505 NÍQUEL SATINADO / SATIN NICKEL
- 1025506 CROMO BRILLANTE / BRILLIANT CHROME
- 1025519 CROMO-NEGRO / BLACK-CHROME
- 102550535 NÍQUEL MADERA / WOOD NICKEL
- 102550635 CROMO MADERA / WOOD CHROME
- 102551935 CROMO-NEGRO MADERA / WOOD BLACK-CHROME

Pantalla inyección de Zamac orientable. Rotación de giro 240°  
*240° orientable Zamac injected hood*

Incluye difusor interior cristal / *Interior opal glass*  
Madera de fresno - color nogal / *Ash tree - walnut coloured*



**ACABADOS / FINISHING**

NÍQUEL SATINADO  
SATIN NICKEL

CROMO BRILLANTE  
BRILLIANT CHROME

CROMO NEGRO  
BLACK CHROME

NOGAL  
WALNUT

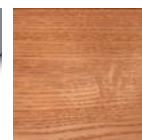



# TRIA

DESIGN: RUBÉN SALDAÑA 2015

## TRIA - 01



8,7 W LED Led 24 x 0,36 = 8,7 W Osram  
Lumens 960 lm  
Valor cromático / CRI 85  
Grados Kelvin / Degrees Kelvin 2700°

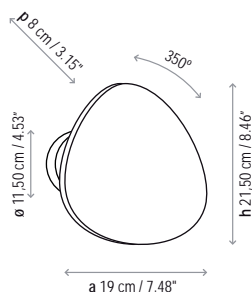

### CONTEMPORÁNEO / APLIQUE CONTEMPORARY / WALL LAMP

- 2080100601 BLANCO LACADO SATINADO / WHITE SATIN LACQUER
- 2080100635 ROBLE NATURAL / NATURAL OAK
- 2080101101 DIM 1-10V BLANCO LACADO SATINADO  
DIM 1-10V WHITE SATIN LACQUER
- 2080101135 DIM 1-10V ROBLE NATURAL  
DIM 1-10V NATURAL OAK

Frontal orientable / Front wall adjustable position  
Frontal de madera / Wood material

## TRIA - 02



13 W LED Led 36 x 0,36 = 13 W Osram  
Lumens 1440 lm  
Valor cromático / CRI 85  
Grados Kelvin / Degrees Kelvin 2700°

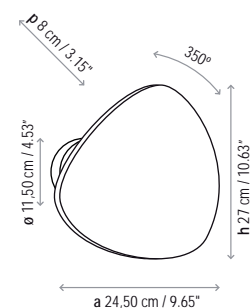

- 2080200601 BLANCO LACADO SATINADO / WHITE SATIN LACQUER
- 2080200635 ROBLE NATURAL / NATURAL OAK
- 2080201101 DIM 1-10V BLANCO LACADO SATINADO  
DIM 1-10V WHITE SATIN LACQUER
- 2080201135 DIM 1-10V ROBLE NATURAL  
DIM 1-10V NATURAL OAK

Frontal orientable / Front wall adjustable position  
Frontal de madera / Wood material

## TRIA - 03



17 W LED Led 48 x 0,36 = 17 W Osram  
Lumens 1920 lm  
Valor cromático / CRI 85  
Grados Kelvin / Degrees Kelvin 2700°

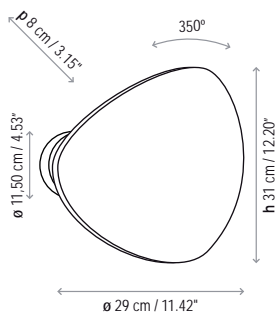

- 2080300601 BLANCO LACADO SATINADO / WHITE SATIN LACQUER
- 2080300635 ROBLE NATURAL / NATURAL OAK
- 2080301101 DIM 1-10V BLANCO LACADO SATINADO  
DIM 1-10V WHITE SATIN LACQUER
- 2080301135 DIM 1-10V ROBLE NATURAL  
DIM 1-10V NATURAL OAK

Frontal orientable / Front wall adjustable position  
Frontal de madera / Wood material

## TRIA - SET 3



39 W LED Led 108 x 0,36 = 39 W Osram  
Lumens 4320 lm  
Valor cromático / CRI 85  
Grados Kelvin / Degrees Kelvin 2700°

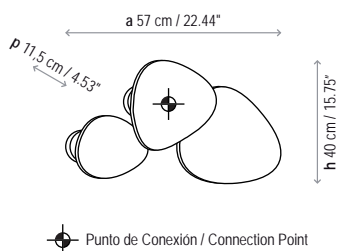

- 2081300601 BLANCO LACADO SATINADO / WHITE SATIN LACQUER
- 2081300635 ROBLE NATURAL / NATURAL OAK
- 2081301101 DIM 1-10V BLANCO LACADO SATINADO  
DIM 1-10V WHITE SATIN LACQUER
- 2081301135 DIM 1-10V ROBLE NATURAL  
DIM 1-10V NATURAL OAK

**Custom finish**  
Colores especiales: Por favor, indiquen el nº RAL.  
Special colors: RAL number to be indicated.

Frontal orientable / Front wall adjustable position  
Frontal de madera / Wood material  
Punto conexión central / Central connection

### ACABADOS / FINISHING

- ROBLE NATURAL OAK WOOD
- BLANCO SATINADO WHITE SATIN







# TRIA

DESIGN: RUBÉN SALDAÑA 2015

## TRIA - SET 6

230V-50Hz



69 W LED Led 192 x 0,36 = 69 W Osram  
Lumens 7080 lm  
Valor cromático / CRI 85  
Grados Kelvin / Degrees Kelvin 2700°

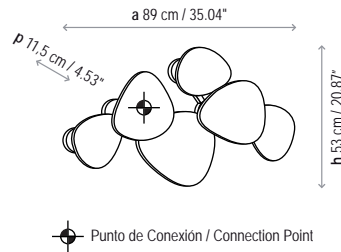

Punto de Conexión / Connection Point

### CONTEMPORÁNEO / APLIQUE CONTEMPORARY / WALL LAMP

- 2081600601 BLANCO LACADO SATINADO / WHITE SATIN LACQUER
- 2081600635 ROBLE NATURAL / NATURAL OAK
- 2081601101 DIM 1-10V BLANCO LACADO SATINADO  
DIM 1-10V WHITE SATIN LACQUER
- 2081601135 DIM 1-10V ROBLE NATURAL  
DIM 1-10V NATURAL OAK

#### Custom finish

Colores especiales: Por favor, indiquen el nº RAL.  
Special colors: RAL number to be indicated.

Frontal orientable / Front wall adjustable position  
Frontal de madera / Wood material  
Punto conexión central / Central connection

## TRIA - SET 8

230V-50Hz



103,4 W LED Led 288 x 0,36 = 103,4 W Osram  
Lumens 11520 lm  
Valor cromático / CRI 85  
Grados Kelvin / Degrees Kelvin 2700°

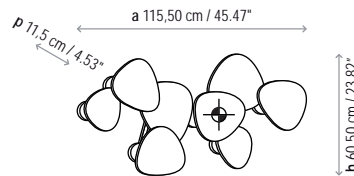

Punto de Conexión / Connection Point

- 2081800601 BLANCO LACADO SATINADO / WHITE SATIN LACQUER
- 2081800635 ROBLE NATURAL / NATURAL OAK
- 2081601101 DIM 1-10V BLANCO LACADO SATINADO  
DIM 1-10V WHITE SATIN LACQUER
- 2081601135 DIM 1-10V ROBLE NATURAL  
DIM 1-10V NATURAL OAK

#### Custom finish

Colores especiales: Por favor, indiquen el nº RAL.  
Special colors: RAL number to be indicated.

Frontal orientable / Front wall adjustable position  
Frontal de madera / Wood material  
Punto conexión central / Central connection



### ACABADOS / FINISHING

ROBLE NATURAL OAK WOOD      BLANCO SATINADO WHITE SATIN







# TWALL

DESIGN: CHRISTOPHE MATHIEU 2004

CONTEMPORÁNEO / APLIQUE  
CONTEMPORARY / WALL LAMP

IP-20 230V~50Hz CE

2 x 60 W G-9 (HALOPIN ECO)

2 x 3,5 W LED G-9

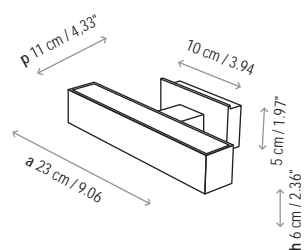

1119705  
1119706

NÍQUEL SATINADO / SATIN NICKEL  
CROMO BRILLANTE / BRILLIANT CHROME



### ACABADOS / FINISHING

NÍQUEL SATINADO  
SATIN NICKEL

CROMO BRILLANTE  
BRILLIANT CHROME

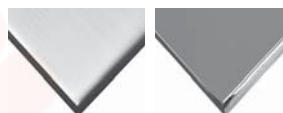



LUSTRO

**CONTEMPORÁNEO / SUSPENSIÓN**  
**CONTEMPORARY / PENDANT LAMP**

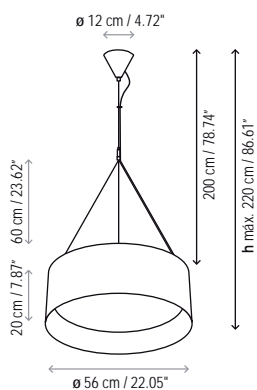
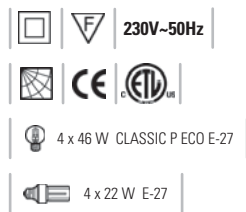

- 4132601 BLANCO LACADO BRILLANTE / *WHITE BRILLIANT LACQUER*
- 4132623 NEGRO LACADO BRILLANTE / *BLACK BRILLIANT LACQUER*
- 4132622 ROJO LACADO BRILLANTE / *RED BRILLIANT LACQUER*

Acabados: Poliuretano acabado lacado brillante  
*Finishing: Polyurethane/brilliant lacquer finish*

**FAMILIA / FAMILY**

pàg 102 154



**ACABADOS / FINISHING**

LACADO ROJO  
*RED LACQUER*

LACADO BLANCO  
*WHITE LACQUER*

LACADO NEGRO  
*BLACK LACQUER*







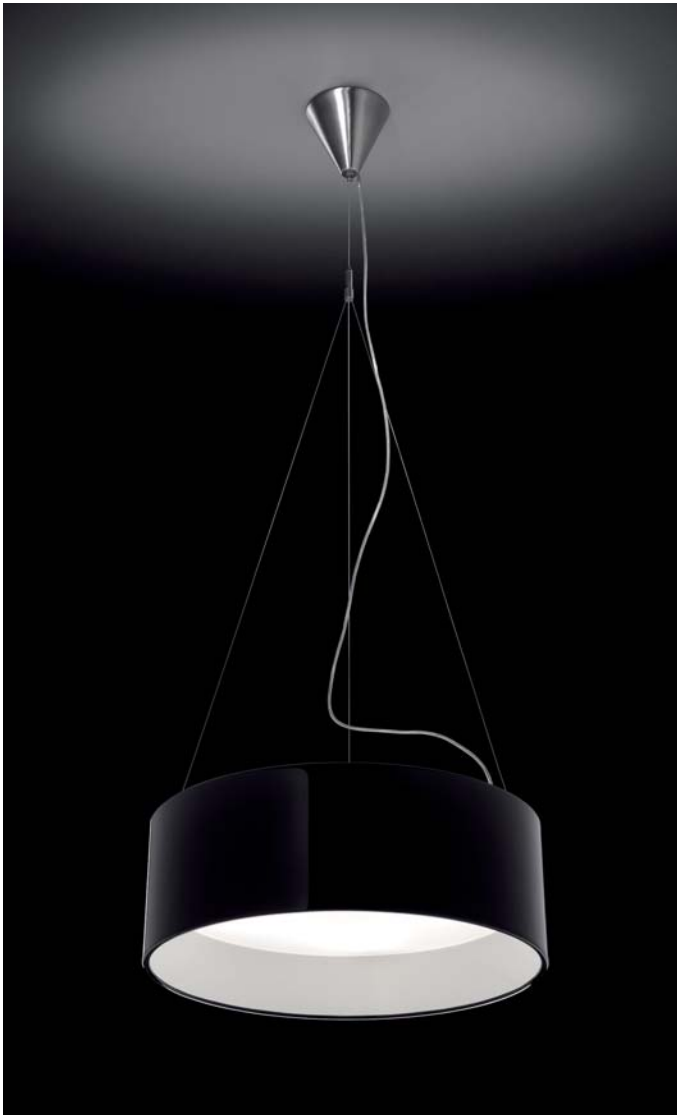







## CONTEMPORÁNEO / SUSPENSIÓN CONTEMPORARY / PENDANT LAMP

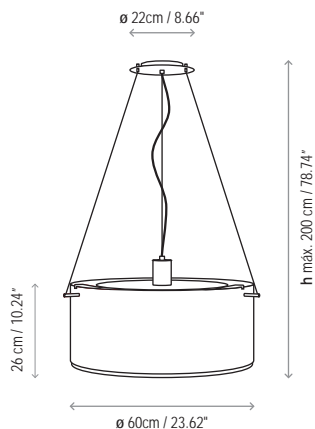

4132812 NEGRO MATE-NÍQUEL / MATTE BLACK-NICKEL

### PANTALLA / LAMPSHADE

Pantalla aluminio negro  
Black aluminum shade

Interior PVC blanco B1 Flame Resistant  
White PVC interior B1 Flame Resistant

Incluye difusor superior de aluminio  
Upper aluminum diffuser included

Incluye difusor inferior de cristal  
Bottom glass diffuser included



### FAMILIA / FAMILY

pàg70 70 106 162 178

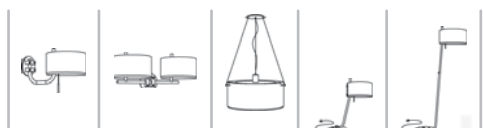

### ACABADOS / FINISHING

NÍQUEL SATINADO SATIN NICKEL      NEGRO MATE MATTE BLACK

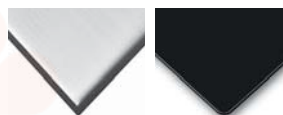



**ELEA - 55**

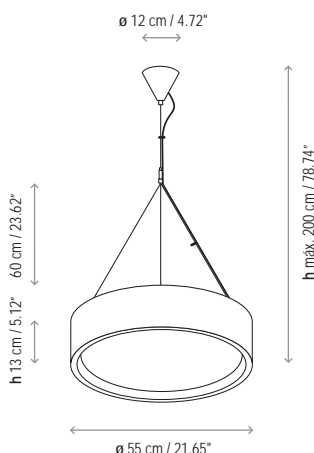
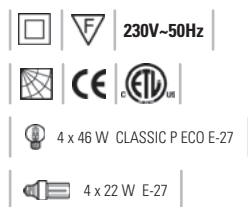

- 41032401 BLANCO LACADO BRILLANTE / WHITE BRILLIANT LACQUER
- 41032422 ROJO LACADO BRILLANTE / RED BRILLIANT LACQUER
- 41032423 NEGRO LACADO BRILLANTE / BLACK BRILLIANT LACQUER

Acabados: Poliuretano acabado lacado brillante  
Finishing: Polyurethane/brilliant lacquer finish  
Difusor cristal óptico / Optical glass diffuser

**ELEA - 85** **BIG FORMAT**

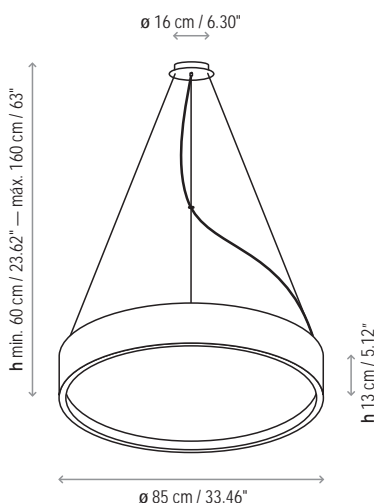

- 410332401 BLANCO LACADO BRILLANTE / WHITE BRILLIANT LACQUER
- 410332422 ROJO LACADO BRILLANTE / RED BRILLIANT LACQUER
- 410332423 NEGRO LACADO BRILLANTE / BLACK BRILLIANT LACQUER

- D410332401 REGULABLE SISTEMA DALI-BLANCO LACADO BRILLANTE  
DALI DIMMING SYSTEM - WHITE BRILLIANT LACQUER
- D410332422 REGULABLE SISTEMA DALI-ROJO LACADO BRILLANTE  
DALI DIMMING SYSTEM - RED BRILLIANT LACQUER
- D410332423 REGULABLE SISTEMA DALI-NEGRO LACADO BRILLANTE  
DALI DIMMING SYSTEM - BLACK BRILLIANT LACQUER

Acabados: Poliuretano acabado lacado brillante  
Finishing: Polyurethane/brilliant lacquer finish  
Difusor cristal óptico / Optical glass diffuser

**ELEA - LP 95**

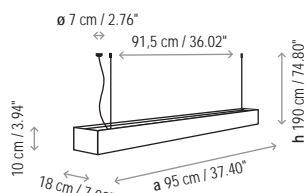

- 3330121101 BLANCO LACADO BRILLANTE / WHITE BRILLIANT LACQUER
- 3330121123 NEGRO LACADO BRILLANTE / BLACK BRILLIANT LACQUER

- 3330121201 REGULABLE SISTEMA DALI / BLANCO LACADO BRILLANTE  
DALI DIMMING SYSTEM / WHITE BRILLIANT LACQUER
- 3330121222 REGULABLE SISTEMA DALI / ROJO LACADO BRILLANTE  
DALI DIMMING SYSTEM / RED BRILLIANT LACQUER
- 3330121223 REGULABLE SISTEMA DALI / NEGRO LACADO BRILLANTE  
DALI DIMMING SYSTEM / BLACK BRILLIANT LACQUER

Acabados: Poliuretano acabado lacado brillante  
Finishing: Polyurethane/brilliant lacquer finish

**FAMILIA / FAMILY**

pàg 108 108 158 158 158



**ACABADOS / FINISHING**

LACADO ROJO RED LACQUER    LACADO BLANCO WHITE LACQUER    LACADO NEGRO BLACK LACQUER







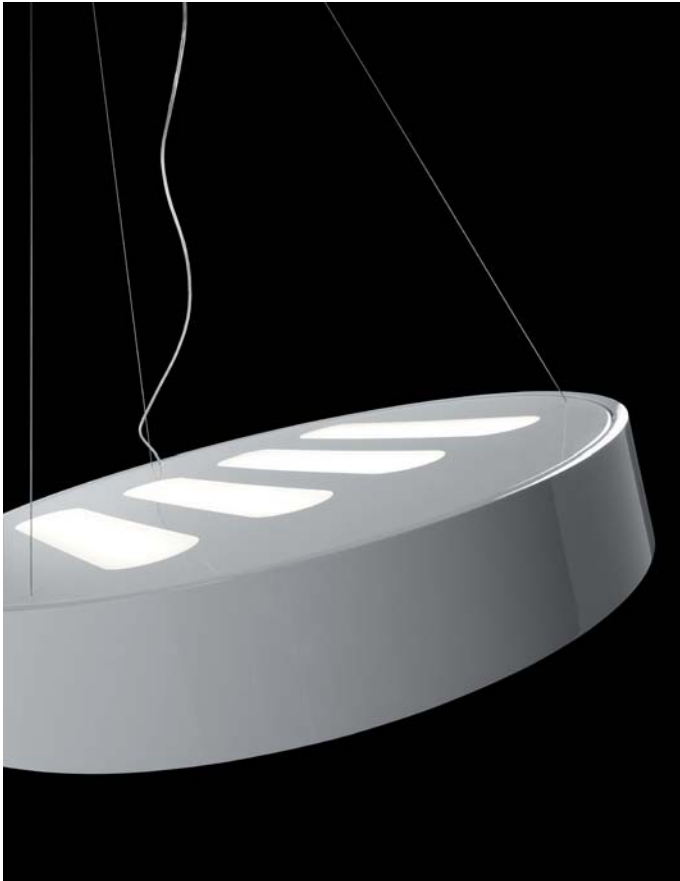















# ELIPSE

DESIGN: ALEX FERNÁNDEZ CAMPS / GONZALO MILÀ 2011

**CONTEMPORÁNEO / SUSPENSIÓN**  
**CONTEMPORARY / PENDANT LAMP**

## ELIPSE - 30

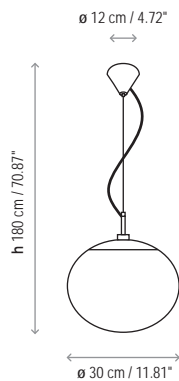
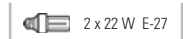

- 4032301 BOLA 30 - BLANCO / BALL 30 - WHITE
- 4032305 BOLA 30 - NÍQUEL / BALL 30 - NICKEL

Globo de polietileno de media densidad y protección UV/light  
*Polyethylene globe of medium density and UV/light protection*

## ELIPSE - 50

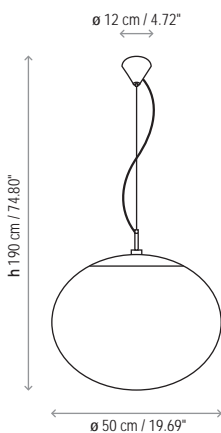

- 4132301 BOLA 50 - BLANCO / BALL 50 - WHITE
- 4132305 BOLA 50 - NÍQUEL / BALL 50 - NICKEL

Globo de polietileno de media densidad y protección UV/light  
*Polyethylene globe of medium density and UV/light protection*











# HARDY

DESIGN: SERGI DEVESA / ÒSCAR DEVESA 2013

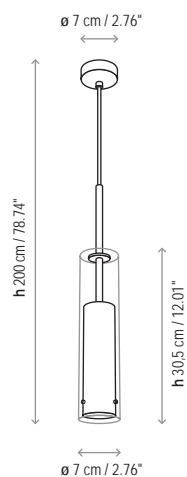

## CONTEMPORÁNEO / SUSPENSIÓN CONTEMPORARY / PENDANT LAMP

- 4131206 CROMO - VIDRIO / CHROME - GLASS
- 4131221 BLANCO - VIDRIO / WHITE - GLASS
- 4131299 DORADO - VIDRIO / GOLD - GLASS

Bombilla LED incluida / LED bulb included  
Altura regulable / Adjustable wire  
Material: Cristal borosilicato / Borosilicate glass

### ACABADOS / FINISHING

NÍQUEL SATINADO  
SATIN NICKEL

BLANCO  
WHITE

ORO  
GOLD

















3 x 46 W CLASSIC P ECO E-27

3 x 11 W E-27

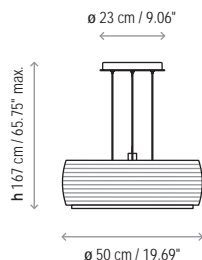

## CONTEMPORÁNEO / SUSPENSIÓN CONTEMPORARY / PENDANT LAMP

4120205 NÍQUEL-CRISTAL OPAL GRABADO  
NICKEL-OPAL GLASS

4120206 CROMO-CRISTAL OPAL GRABADO  
CHROME-OPAL GLASS

Debido a la naturaleza del cristal soplado, pueden aparecer pequeñas burbujas o variaciones que no se consideran defectos.

*Due to the nature of the hand blown cristal, natural variations should be expected and will not be considered an imperfection.*

### FAMILIA / FAMILY

pàg 124 164 180

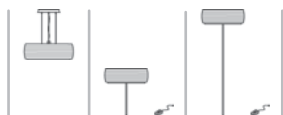

### ACABADOS / FINISHING

NÍQUEL SATINADO  
SATIN NICKEL

CROMO BRILLANTE  
BRILLIANT CHROME

CRISTAL OPAL GRABADO  
OPAL GLASS











# NÓN LÁ

DESIGN: JORGE PENSI DESIGN STUDIO 2015

**CONTEMPORÁNEO / SUSPENSIÓN**  
**CONTEMPORARY / PENDANT LAMP**

230V-50Hz

CE ENEC

10,5 W LED Led 35 x 0,3 = 10,5 W Osram  
Lumens 1200 lm  
Valor cromático / CRI 85  
Grados Kelvin / Degrees Kelvin 2700°

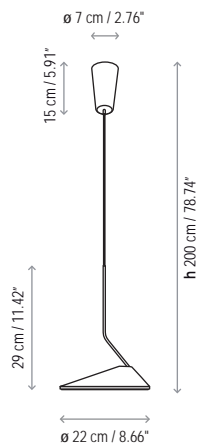

- 3320120101 BLANCO LACADO BRILLANTE / WHITE BRILLIANT LACQUER
- 3320120106 CROMO / CHROME
- 3320120123 NEGRO LACADO BRILLANTE / BLACK BRILLIANT LACQUER
- 3320120190 COBRE BRILLANTE / BRILLIANT COPPER

Regulación electrónica 1-10V / 1-10V Electronic dimming

- 3320120401 BLANCO LACADO BRILLANTE / WHITE BRILLIANT LACQUER
- 3320120406 CROMO / CHROME
- 3320120423 NEGRO LACADO BRILLANTE / BLACK BRILLIANT LACQUER
- 3320120490 COBRE BRILLANTE / BRILLIANT COPPER

Pantalla orientable / Adjustable shade  
Cabezal de aluminio / Aluminium hood

**FAMILIA / FAMILY**

pàg 84 84 128 132 132 132 168

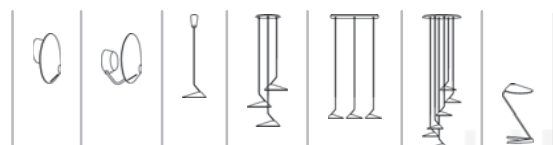

**ACABADOS / FINISHING**

LACADO BLANCO WHITE LACQUER    LACADO NEGRO BLACK LACQUER    CROMO CHROME    COBRE BRILLO BRILLIANT COPPER

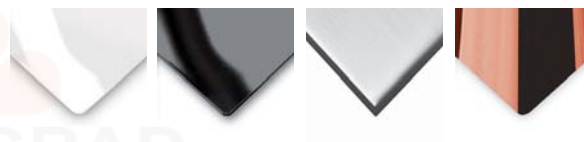









# NÓN LÁ

DESIGN: JORGE PENSI DESIGN STUDIO 2015

## NÓN LÁ - SET 3 CIRCULAR



31,5 W LED | Led 105 x 0,3 = 31,5 W Osram  
Lumens 3600 lm  
Valor cromático / CRI 85  
Grados Kelvin / Degrees Kelvin 2700°

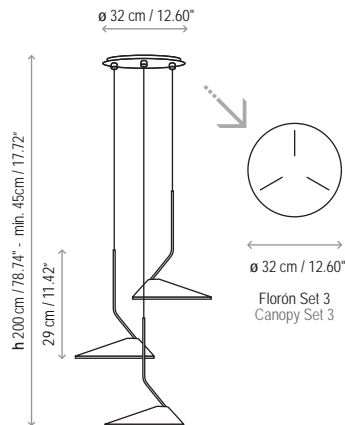

### CONTEMPORÁNEO / SUSPENSIÓN CONTEMPORARY / PENDANT LAMP

- 3320320101 BLANCO LACADO BRILLANTE / WHITE BRILLIANT LACQUER
- 3320320106 CROMO / CHROME
- 3320320123 NEGRO LACADO BRILLANTE / BLACK BRILLIANT LACQUER
- 3320320190 COBRE BRILLANTE / BRILLIANT COPPER

Regulación electrónica 1-10V / 1-10V Electronic dimming

- 3320320401 BLANCO LACADO BRILLANTE / WHITE BRILLIANT LACQUER
- 3320320406 CROMO / CHROME
- 3320320423 NEGRO LACADO BRILLANTE / BLACK BRILLIANT LACQUER
- 3320320490 COBRE BRILLANTE / BRILLIANT COPPER

Pantalla orientable / Adjustable shade  
Cabezal de aluminio / Aluminium hood

## NÓN LÁ - SET 3 RECTANGULAR

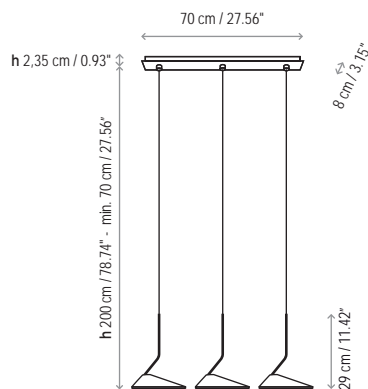

- 3320420101 BLANCO LACADO BRILLANTE / WHITE BRILLIANT LACQUER
- 3320420106 CROMO / CHROME
- 3320420123 NEGRO LACADO BRILLANTE / BLACK BRILLIANT LACQUER
- 3320420190 COBRE BRILLANTE / BRILLIANT COPPER

Regulación electrónica 1-10V / 1-10V Electronic dimming

- 3320420401 BLANCO LACADO BRILLANTE / WHITE BRILLIANT LACQUER
- 3320420406 CROMO / CHROME
- 3320420423 NEGRO LACADO BRILLANTE / BLACK BRILLIANT LACQUER
- 3320420490 COBRE BRILLANTE / BRILLIANT COPPER

Pantalla orientable / Adjustable shade  
Cabezal de aluminio / Aluminium hood

## NÓN LÁ - SET 6 CIRCULAR



63 W LED | Led 210 x 0,3 = 63 W Osram  
Lumens 7200 lm  
Valor cromático / CRI 85  
Grados Kelvin / Degrees Kelvin 2700°

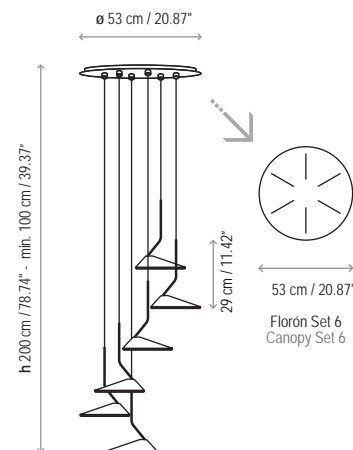

- 3320620101 BLANCO LACADO BRILLANTE / WHITE BRILLIANT LACQUER
- 3320620106 CROMO / CHROME
- 3320620123 NEGRO LACADO BRILLANTE / BLACK BRILLIANT LACQUER
- 3320620190 COBRE BRILLANTE / BRILLIANT COPPER

Regulación electrónica 1-10V / 1-10V Electronic dimming

- 3320620401 BLANCO LACADO BRILLANTE / WHITE BRILLIANT LACQUER
- 3320620406 CROMO / CHROME
- 3320620423 NEGRO LACADO BRILLANTE / BLACK BRILLIANT LACQUER
- 3320620490 COBRE BRILLANTE / BRILLIANT COPPER

Pantalla orientable / Adjustable shade  
Cabezal de aluminio / Aluminium hood

### FAMILIA / FAMILY

pàg 84 84 128 132 132 132 168

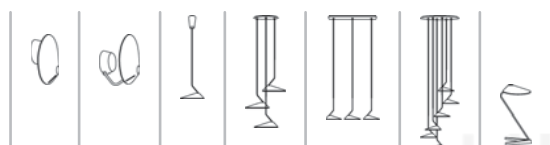

### ACABADOS / FINISHING

LACADO BLANCO / WHITE LACQUER    LACADO NEGRO / BLACK LACQUER    CROMO / CHROME    COBRE BRILLO / BRILLIANT COPPER

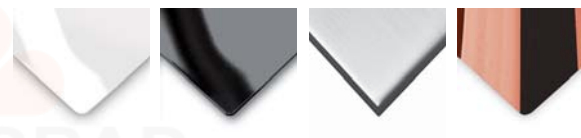





# SLEND

DESIGN: CHRISTOPHE MATHIEU 2014

## SLEND - 01

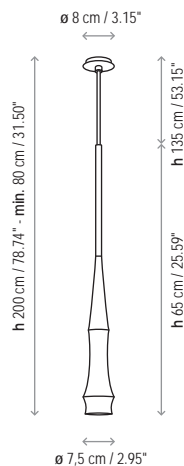

## CONTEMPORÁNEO / SUSPENSIÓN CONTEMPORARY / PENDANT LAMP

- 2560120064 ALUMINIO PULIDO - FLORÓN CROMO - CABLE TRANSP.  
POLISHED ALUMINUM - CHROME CANOPY - TRANSP. WIRE
- 2560120001 BLANCO BRILLO - FLORÓN BLANCO - CABLE BLANCO  
BRILLIANT WHITE - WHITE CANOPY - WHITE WIRE
- 2560120023 NEGRO BRILLO - FLORÓN NEGRO - CABLE NEGRO  
BRILLIANT BLACK - BLACK CANOPY - BLACK WIRE

Acabado mate disponible (consultar) / Matte finish available (please consult)

Para el cambio de acabado es necesario indicar el nº de RAL.  
Las unidades mínimas son 5.

Special colors: RAL number to be indicated. Minimum quantity: 5 pieces.

Altura regulable por el usuario / Adjustable height by the user  
Bombilla LED incluida / LED bulb included

## SLEND - 02

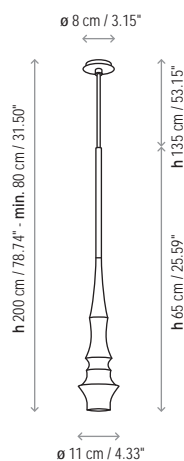

- 2560220064 ALUMINIO PULIDO - FLORÓN CROMO - CABLE TRANSP.  
POLISHED ALUMINUM - CHROME CANOPY - TRANSP. WIRE
- 2560220001 BLANCO BRILLO - FLORÓN BLANCO - CABLE BLANCO  
BRILLIANT WHITE - WHITE CANOPY - WHITE WIRE
- 2560220023 NEGRO BRILLO - FLORÓN NEGRO - CABLE NEGRO  
BRILLIANT BLACK - BLACK CANOPY - BLACK WIRE

Acabado mate disponible (consultar) / Matte finish available (please consult)

Para el cambio de acabado es necesario indicar el nº de RAL.  
Las unidades mínimas son 5.

Special colors: RAL number to be indicated. Minimum quantity: 5 pieces.

Altura regulable por el usuario / Adjustable height by the user  
Bombilla LED incluida / LED bulb included

## SLEND - 03

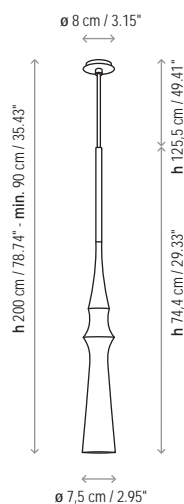

- 2560320064 ALUMINIO PULIDO - FLORÓN CROMO - CABLE TRANSP.  
POLISHED ALUMINUM - CHROME CANOPY - TRANSP. WIRE
- 2560320001 BLANCO BRILLO - FLORÓN BLANCO - CABLE BLANCO  
BRILLIANT WHITE - WHITE CANOPY - WHITE WIRE
- 2560320023 NEGRO BRILLO - FLORÓN NEGRO - CABLE NEGRO  
BRILLIANT BLACK - BLACK CANOPY - BLACK WIRE

Acabado mate disponible (consultar) / Matte finish available (please consult)

Para el cambio de acabado es necesario indicar el nº de RAL.  
Las unidades mínimas son 5.

Special colors: RAL number to be indicated. Minimum quantity: 5 pieces.

Altura regulable por el usuario / Adjustable height by the user  
Bombilla LED incluida / LED bulb included



### ACABADOS / FINISHING

- ALUMINIO PULIDO / POLISHED ALUMINUM
- BLANCO BRILLANTE / BRILLIANT WHITE
- NEGRO BRILLANTE / BRILLIANT BLACK



Matt finish available  
please consult





INTERIOR DESIGN  
**BEST OF  
YEAR HONOREE  
2014**





**Hotel Can Cuc / Cànoves**



# SLEND

DESIGN: CHRISTOPHE MATHIEU 2014

## SLEND - SET 3 CIRCULAR

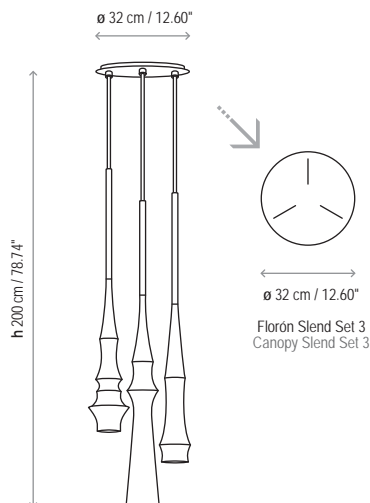

## CONTEMPORÁNEO / SUSPENSIÓN CONTEMPORARY / PENDANT LAMP

- 2560420064 ALUMINIO PULIDO - FLORÓN BLANCO - CABLE TRANSP.  
POLISHED ALUMINUM - WHITE CANOPY - TRANSP. WIRE
- 2560420001 BLANCO BRILLO - FLORÓN BLANCO - CABLE BLANCO  
BRILLIANT WHITE - WHITE CANOPY - WHITE WIRE
- 2560420023 NEGRO BRILLO - FLORÓN NEGRO - CABLE NEGRO  
BRILLIANT BLACK - BLACK CANOPY - BLACK WIRE

Acabado mate disponible (consultar)  
Matte finish available (please consult)

Bombilla LED incluida / LED bulb included  
Altura regulable por el usuario / Adjustable height by the user  
Incluye un modelo de cada luminaria con el mismo acabado  
Includes a fitting of each (Slend 01, 02, 03) with the same finishings.

## SLEND - SET 3 RECTANGULAR

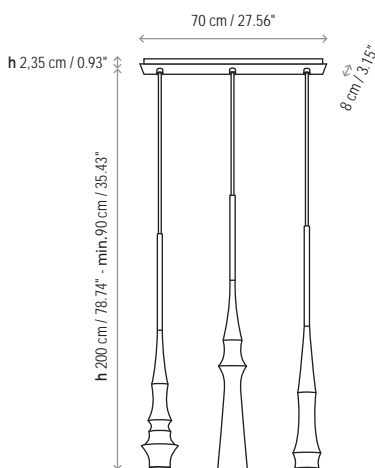

- 2560620064 ALUMINIO PULIDO - CAJA BLANCA - CABLE TRANSP.  
POLISHED ALUMINUM - WHITE PLATE - TRANSP. WIRE
- 2560620001 BLANCO BRILLO - CAJA BLANCA - CABLE BLANCO  
BRILLIANT WHITE - WHITE PLATE - WHITE WIRE
- 2560620023 NEGRO BRILLO - CAJA NEGRA - CABLE NEGRO  
BRILLIANT BLACK - BLACK PLATE - BLACK WIRE

Acabado mate disponible (consultar)  
Matte finish available (please consult)

Bombilla LED incluida / LED bulb included  
Altura regulable por el usuario / Adjustable height by the user  
Incluye un modelo de cada luminaria con el mismo acabado  
Includes a fitting of each (Slend 01, 02, 03) with the same finishings.

## SLEND - SET 6 CIRCULAR

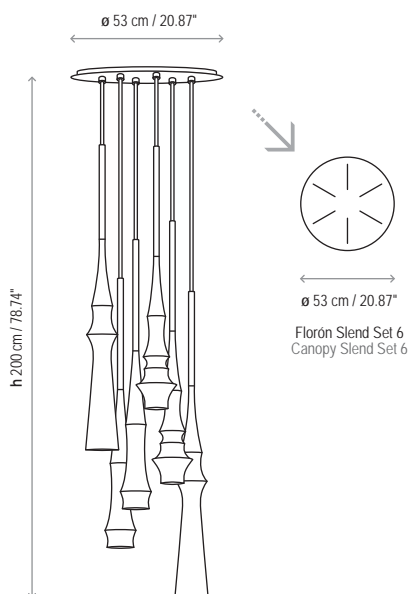

- 2560520064 ALUMINIO PULIDO - FLORÓN BLANCO - CABLE TRANSP.  
POLISHED ALUMINUM - WHITE CANOPY - TRANSP. WIRE
- 2560520001 BLANCO BRILLO - FLORÓN BLANCO - CABLE BLANCO  
BRILLIANT WHITE - WHITE CANOPY - WHITE WIRE
- 2560520023 NEGRO BRILLO - FLORÓN NEGRO - CABLE NEGRO  
BRILLIANT BLACK - BLACK CANOPY - BLACK WIRE

Acabado mate disponible (consultar)  
Matte finish available (please consult)

Bombilla LED incluida / LED bulb included  
Altura regulable por el usuario / Adjustable height by the user  
Incluye dos modelos de cada luminaria con el mismo acabado  
Includes two fittings of each (Slend 01, 02, 03)

### ACABADOS / FINISHING

- ALUMINIO PULIDO / POLISHED ALUMINUM
- BLANCO BRILLANTE / BRILLIANT WHITE
- NEGRO BRILLANTE / BRILLIANT BLACK



Matte finish available  
please consult











# SYRA 45 INDOOR

DESIGN: ALEX FERNÁNDEZ CAMPS / GONZALO MILÀ 2014

230V-50Hz

CE ENEC

17 W LED Led 54 x 0.33 W = 17 W Osram  
Lumens 2050 lm  
Valor cromático / CRI/85  
Grados Kelvin / Degrees Kelvin 2700°

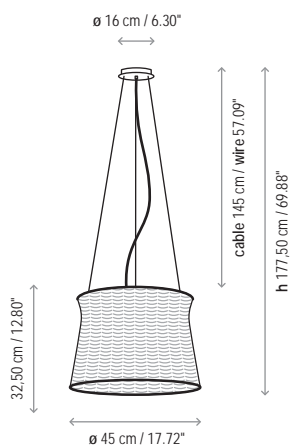

## CONTEMPORÁNEO / SUSPENSIÓN CONTEMPORARY / PENDANT LAMP

2640120158 BLANCO / WHITE  
2640120159 MARRÓN CHOCOLATE / CHOCOLATE BROWN

2640120958 REGULABLE SISTEMA DALI / BLANCO  
DALI DIMMING SYSTEM / WHITE

2640120959 REGULABLE SISTEMA DALI / MARRÓN CHOCOLATE  
DALI DIMMING SYSTEM / CHOCOLATE BROWN

El modelo Syra 45 no es apto para aplicaciones de Outdoor.  
La luminaria no dispone de IP-55.  
*Syra 45 is not suitable for the Outdoors.  
The luminaire does not have IP-55.*

### FAMILIA / FAMILY

pàg 54

54

142



**SYRA - 60 / 90  
OUTDOOR**



**SYRA - 45  
ONLY INDOOR  
APPLICATION**

### ACABADOS / FINISHING

BLANCO  
WHITE

MARRÓN CHOCOLATE  
CHOCOLATE BROWN

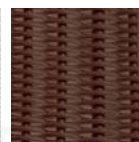
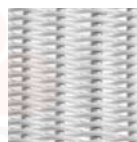









# TIBETA

DESIGN: CHRISTOPHE MATHIEU 2015

**CONTEMPORÁNEO / SUSPENSIÓN**  
**CONTEMPORARY / PENDANT LAMP**

## TIBETA - 01

230V-50Hz



1 x 8,7 W LED | Led 8,7 W  
Lumens 610 lm  
Valor cromático / CRI 80  
Grados Kelvin / Degrees Kelvin  
2900°-3200°

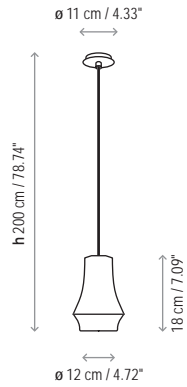

- 2570120107 CROMO NEGRO - CABLE TEXTIL NEGRO  
*BLACK CHROME - BLACK WIRE TEXTIL*
- 2570120164 ALUMINIO PULIDO - CABLE TEXTIL GRIS  
*POLISHED ALUMINUM - GREY FABRIC WIRE*
- 2570120190 COBRE BRILLO - CABLE METÁLICO COLOR COBRE  
*BRILLANT COPPER - COPPER METALIC MESH*

DIMABLE TRIAC (como las bombillas de led dimables) /  
*TRIAC DIMMABLE (like retrofit dimmable led bulbs)*

## TIBETA - 02

230V-50Hz



1 x 8,7 W LED | Led 8,7 W  
Lumens 610 lm  
Valor cromático / CRI 80  
Grados Kelvin / Degrees Kelvin  
2900°-3200°

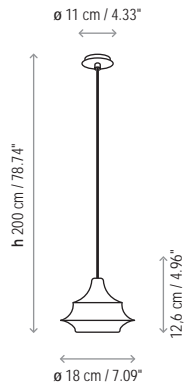

- 2570220107 CROMO NEGRO - CABLE TEXTIL NEGRO  
*BLACK CHROME - BLACK WIRE TEXTIL*
- 2570220164 ALUMINIO PULIDO - CABLE TEXTIL GRIS  
*POLISHED ALUMINUM - GREY FABRIC WIRE*
- 2570220190 COBRE BRILLO - CABLE METÁLICO COLOR COBRE  
*BRILLANT COPPER - COPPER METALIC MESH*

DIMABLE TRIAC (como las bombillas de led dimables) /  
*TRIAC DIMMABLE (like retrofit dimmable led bulbs)*

## TIBETA - 03

230V-50Hz



1 x 13 W LED | Led 13 W  
Lumens 935 lm  
Valor cromático / CRI 80  
Grados Kelvin / Degrees Kelvin  
2900°-3200°

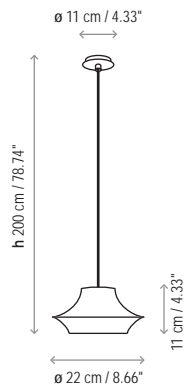

- 2570320107 CROMO NEGRO - CABLE TEXTIL NEGRO  
*BLACK CHROME - BLACK WIRE TEXTIL*
- 2570320164 ALUMINIO PULIDO - CABLE TEXTIL GRIS  
*POLISHED ALUMINUM - GREY FABRIC WIRE*
- 2570320190 COBRE BRILLO - CABLE METÁLICO COLOR COBRE  
*BRILLANT COPPER - COPPER METALIC MESH*

DIMABLE TRIAC (como las bombillas de led dimables) /  
*TRIAC DIMMABLE (like retrofit dimmable led bulbs)*



### ACABADOS / FINISHING

CROMO NEGRO | ALUMINIO PULIDO | COBRE BRILLO  
*BLACK CHROME | POLISHED ALUMINUM | BRILLIANT COPPER*











## TWINS - 01



1 x 40 W E-27 · ø 64 mm

1 x 16 W E-27 · ø 61 mm

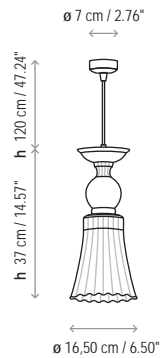

## CONTEMPORÁNEO / SUSPENSIÓN CONTEMPORARY / PENDANT LAMP

410131106 CRISTAL SOPLADO - CABLE TRANSPARENTE  
BLOWN GLASS - TRANSPARENT WIRE

410131122 CRISTAL SOPLADO - CABLE ROJO  
BLOWN GLASS - RED WIRE

 Bombilla decorativa incluida: 40W E27 ø64 mm 230V 180 Lm  
Decorative Bulb included: 40W E27 ø64 mm 230V 180 Lm

No emplear bombillas HALOGEN CLASSIC ECO o incandescentes. Esta luminaria solo acepta bombillas decorativas de filamento o de bajo consumo.  
Do not use HALOGEN CLASSIC ECO or incandescent bulbs. Twins only work with filament decorative bulbs or energy-saving bulbs.

Material: Cristal soplado / Blown glass  
Altura regulable / Adjustable wire

## TWINS - 02



1 x 40 W E-27 · ø 64 mm

1 x 16 W E-27 · ø 61 mm

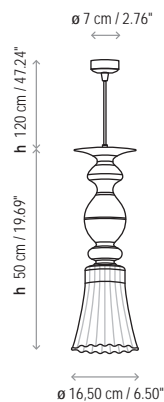

410231106 CRISTAL SOPLADO - CABLE TRANSPARENTE  
BLOWN GLASS - TRANSPARENT WIRE

410231122 CRISTAL SOPLADO - CABLE ROJO  
BLOWN GLASS - RED WIRE

 Bombilla decorativa incluida: 40W E27 ø64 mm 230V 180 Lm  
Decorative Bulb included: 40W E27 ø64 mm 230V 180 Lm

No emplear bombillas HALOGEN CLASSIC ECO o incandescentes. Esta luminaria solo acepta bombillas decorativas de filamento o de bajo consumo.  
Do not use HALOGEN CLASSIC ECO or incandescent bulbs. Twins only work with filament decorative bulbs or energy-saving bulbs.

Material: Cristal soplado / Blown glass  
Altura regulable / Adjustable wire

## ACABADOS / FINISHING

NIQUEL SATINADO  
SATIN NICKEL















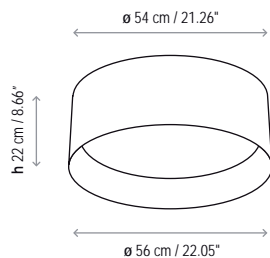

- 5132601 BLANCO LACADO BRILLANTE / *WHITE BRILLIANT LACQUER*
- 5132623 NEGRO LACADO BRILLANTE / *BLACK BRILLIANT LACQUER*
- 5132622 ROJO LACADO BRILLANTE / *RED BRILLIANT LACQUER*

Acabados: Poliuretano acabado lacado brillante  
*Finishing: Polyurethane/brilliant lacquer finish*



**FAMILIA / FAMILY**

pàg 102 154



**ACABADOS / FINISHING**

LACADO ROJO  
*RED LACQUER*

LACADO BLANCO  
*WHITE LACQUER*

LACADO NEGRO  
*BLACK LACQUER*











**ELEA - 55**

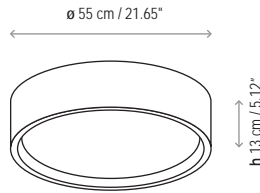

**CONTEMPORÁNEO / PLAFÓN**  
**CONTEMPORARY / CEILING**

- 510232401 BLANCO LACADO BRILLANTE / *WHITE BRILLIANT LACQUER*
- 510232422 ROJO LACADO BRILLANTE / *RED BRILLIANT LACQUER*
- 510232423 NEGRO LACADO BRILLANTE / *BLACK BRILLIANT LACQUER*

**Acabados / Finishing:** acabado lacado brillante / *brilliant lacquer finish*  
**Material:** Poliuretano / *Polyurethane*  
**Difusor cristal óptico / Optical glass diffuser**

**ELEA - 85** **BIG FORMAT**

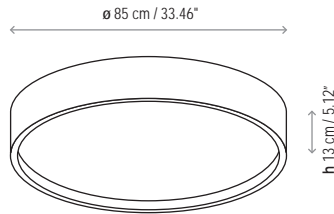

- 510332401 BLANCO LACADO BRILLANTE / *WHITE BRILLIANT LACQUER*
- 510332422 ROJO LACADO BRILLANTE / *RED BRILLIANT LACQUER*
- 510332423 NEGRO LACADO BRILLANTE / *BLACK BRILLIANT LACQUER*

**Acabados / Finishing:** acabado lacado brillante / *brilliant lacquer finish*  
**Material:** Poliuretano / *Polyurethane*  
**Difusor cristal óptico / Optical glass diffuser**

- 510332401 BLANCO LACADO BRILLANTE / *WHITE BRILLIANT LACQUER*
- 510332422 ROJO LACADO BRILLANTE / *RED BRILLIANT LACQUER*
- 510332423 NEGRO LACADO BRILLANTE / *BLACK BRILLIANT LACQUER*

D510332401 REGULABLE SISTEMA DALI-BLANCO LACADO BRILLANTE  
*DALI DIMMING SYSTEM -WHITE BRILLIANT LACQUER*

D510332422 REGULABLE SISTEMA DALI-ROJO LACADO BRILLANTE  
*DALI DIMMING SYSTEM -RED BRILLIANT LACQUER*

D510332423 REGULABLE SISTEMA DALI-NEGRO LACADO BRILLANTE  
*DALI DIMMING SYSTEM -BLACK BRILLIANT LACQUER*

**Acabados / Finishing:** acabado lacado brillante / *brilliant lacquer finish*  
**Material:** Poliuretano / *Polyurethane*  
**Difusor cristal óptico / Optical glass diffuser**

**FAMILIA / FAMILY**

pàg 108 108 158 158 158



**ACABADOS / FINISHING**

LACADO ROJO / *RED LACQUER*      LACADO BLANCO / *WHITE LACQUER*      LACADO NEGRO / *BLACK LACQUER*













1 x 46 W CLASSIC P ECO E-27

1 x 11 W E-27

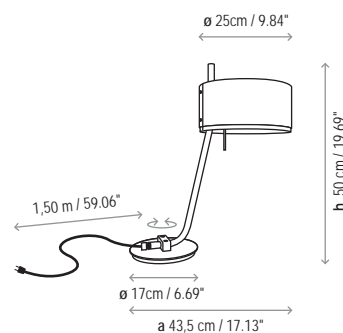

## CONTEMPORÁNEO / MESA CONTEMPORARY / TABLE LAMP

1932812 NEGRO MATE-NÍQUEL / MATTE BLACK-NICKEL

**PANTALLA / LAMPSHADE**  
Pantalla aluminio negro  
*Black aluminum shade*  
Interior PVC blanco B1 Flame Resistant  
*White PVC interior B1 Flame Resistant*  
Incluye difusor superior de aluminio  
*Included aluminum top diffuser*

Base giratoria / *Swivel base*  
Interruptor en portalámparas / *Lampholder switch*



### FAMILIA / FAMILY

påg70 70 106 162 178



### ACABADOS / FINISHING

NÍQUEL SATINADO SATIN NICKEL      NEGRO MATE MATTE BLACK

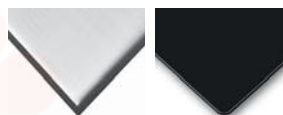







3 x 46 W CLASSIC P ECO E-27

3 x 18 W E-27  
Osram Dulux Intelligent dimmable

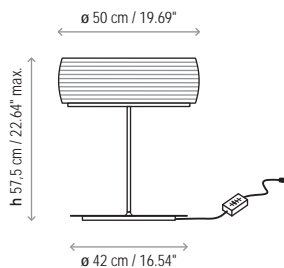

## CONTEMPORÁNEO / MESA CONTEMPORARY / TABLE LAMP

2220205 NÍQUEL-CRISTAL OPAL GRABADO  
NICKEL-OPAL GLASS

2220206 CROMO-CRISTAL OPAL GRABADO  
CHROME-OPAL GLASS

Lámpara con dimmer incorporado / Lamp with incorporated dimmer

Debido a la naturaleza del cristal soplado, pueden aparecer pequeñas burbujas o variaciones que no se consideran defectos.

*Due to the nature of the hand blown cristal, natural variations should be expected and will not be considered an imperfection.*

### FAMILIA / FAMILY

pàg 124 164 180

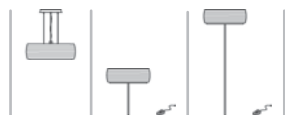

### ACABADOS / FINISHING

NÍQUEL SATINADO  
SATIN NICKEL

CROMO BRILLANTE  
BRILLIANT CHROME

CRISTAL OPAL GRABADO  
OPAL GLASS







# MUF

DESIGN: JOANA BOVER 2007

## MUF - 01

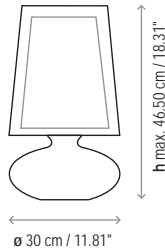

## CONTEMPORÁNEO / MESA CONTEMPORARY / TABLE LAMP

2215521 CRISTAL SOPLADO OPAL-CROMO  
BLOWN OPAL GLASS-CHROME

Pantalla exterior: 27 x 27 x 20 cm / Outer lampshade: 10.63" x 10.63" x 7.87"

P-561 CINTA TRANSLÚCIDA BLANCA / WHITE TRANSLUCENT RIBBON  
P-564E NEGRO / BLACK MESH  
P-565E ROJO / RED MESH

Pantalla Interior : 20 x 26 x 14 cm / Inner lampshade : 7.87" x 10.24" x 5.51"

P-564 NEGRO / BLACK MESH  
P-565 ROJO / RED MESH

- \* Lámpara con 3 posiciones de encendido  
With 3 lighting/mood switch on/off positions
- \*\* Interior pantalla de film poliéster rígido resistente al calor  
Inner shade made of a fire-resistant polyester rigid film
- \*\*\* Las bombillas de la base están incluidas  
The base bulbs are included

## MUF - 02

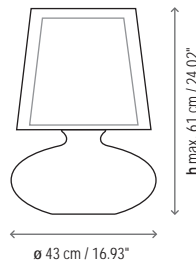

2215522 CRISTAL SOPLADO OPAL-CROMO  
BLOWN OPAL GLASS-CHROME

Pantalla Exterior: 40 x 36 x 31 cm / Outer lampshade: 15.75" x 14.17" x 12.20"

P-580 CINTA TRANSLÚCIDA BLANCA / WHITE TRANSLUCENT RIBBON  
P-570E NEGRO / BLACK MESH  
P-571E ROJO / RED MESH

Pantalla Interior : 30 x 30 x 23 / Inner lampshade : 11.81" x 11.81" x 9.06"

P-570 NEGRO / BLACK MESH  
P-571 ROJO / RED MESH

- \* Lámpara con 3 posiciones de encendido  
With 3 lighting/mood switch on/off positions
- \*\* Interior pantalla de film poliéster rígido resistente al calor  
Inner shade made of a fire-resistant polyester rigid film
- \*\*\* Las bombillas de la base están incluidas  
The base bulbs are included



### ACABADOS / FINISHING

CINTA BLANCA  
WHITE RIBBON

MALLA NEGRA  
BLACK MESH

MALLA ROJA  
RED MESH

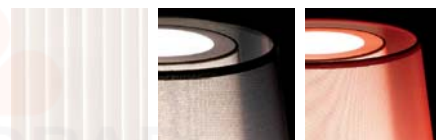





# NÓN LÁ

DESIGN: JORGE PENSI DESIGN STUDIO 2015

CONTEMPORÁNEO / MESA  
CONTEMPORARY / TABLE LAMP



10,5 W LED Led 35 x 0,3 = 10,5 W Osram  
Lumens 1200 lm  
Valor cromático / CRI 85  
Grados Kelvin / Degrees Kelvin 2700°

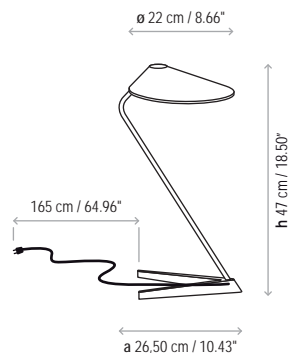

- 3320130301 BLANCO LACADO BRILLANTE / WHITE BRILLIANT LACQUER
- 3320130306 CROMO / CHROME
- 3320130323 NEGRO LACADO BRILLANTE / BLACK BRILLIANT LACQUER
- 3320130390 COBRE BRILLANTE / BRILLIANT COPPER

Switch with three brightness levels

## FAMILIA / FAMILY

pàg 84 84 128 132 132 132 168

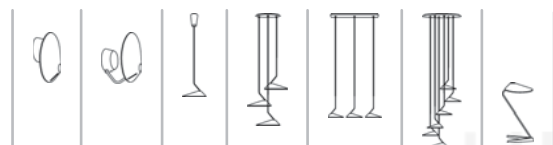

## ACABADOS / FINISHING

LACADO BLANCO / WHITE LACQUER  
 LACADO NEGRO / BLACK LACQUER  
 CROMO / CHROME  
 COBRE BRILLO / BRILLIANT COPPER

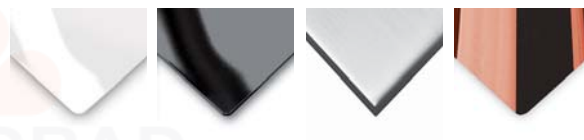





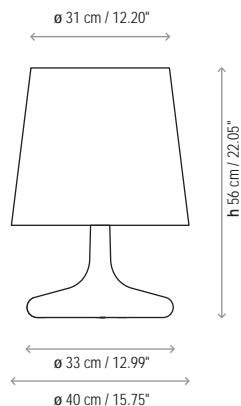

## CONTEMPORÁNEO / MESA CONTEMPORARY / TABLE LAMP

- 2210621 BLANCO LACADO BRILLANTE / *WHITE BRILLIANT LACQUER*
- 2210617 NEGRO LACADO BRILLANTE / *BLACK BRILLIANT LACQUER*
- 2210622 ROJO LACADO BRILLANTE / *RED BRILLIANT LACQUER*

Pantalla 40 x 35,5 x 31 cm / *Lampshade 15.75" x 13.98" x 12.20"*  
Incluye difusor metacrilato espejo para pantallas blancas y difusor metacrilato espejo negro para pantallas negras.  
*Diffuser included: silver-mirror methacrylate with white shade and black-mirror methacrylate with black shade.*

- P-660 CINTA TRANSLÚCIDA BLANCA / *WHITE TRANSLUCENT RIBBON*
- P-761 CINTA TRANSLÚCIDA ROJA / *RED TRANSLUCENT RIBBON*
- P-658 NEGRO - INTERIOR NARANJA  
*BLACK FABRIC - ORANGE INSIDE*
- P-659 BLANCO - INTERIOR NARANJA  
*WHITE FABRIC - ORANGE INSIDE*

Base: Poliuretano acabado lacado brillante  
*Base: Polyurethane/brilliant lacquer finish*



### ACABADOS / FINISHING

CINTA BLANCA  
*WHITE RIBBON*

COTONET BLANCO  
*COTTON WHITE*

COTONET NEGRO  
*COTTON BLACK*

CINTA ROJA  
*RED RIBBON*













# SPOCK

DESIGN: CHRISTOPHE MATHIEU 2007



3,6 W LED | Led: 12 x 0,3 W = 3,6 W Osram  
Lumens: 444 lm @80°C  
Valor cromático / CRI: 85  
Grados Kelvin  
Degrees Kelvin: 3000°

DRIVE CONECTOR

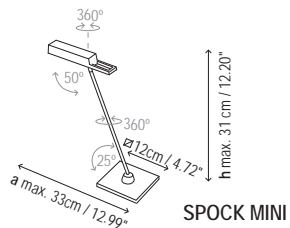
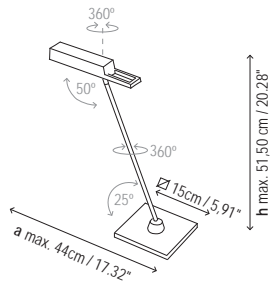
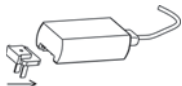

## CONTEMPORÁNEO / MESA CONTEMPORARY / TABLE LAMP

1910512L LED CROMO / LED CHROME  
1910511L LED CROMO-BLANCO / LED CHROME-WHITE

**SPOCK MINI**  
2010512L LED CROMO / LED CHROME  
2010511L LED CROMO-BLANCO / LED CHROME-WHITE

Pantalla de inyección de zamac orientable / Zamac injected orientable hood  
Base de acero inoxidable / Stainless steel base

DIFUSOR : Rotación circular 360° / Rotación vertical 50°  
DIFFUSER: Circular rotation 360° / Vertical rotation 50°  
MÁSTIL: Rotación circular 360° / Inclinación mástil 25°  
MAST: Circular rotation 360° / Mast inclination 25°

## FAMILIA / FAMILY

pàg 92    174    174    182



## ACABADOS / FINISHING

CROMO BRILLANTE    BLANCO  
BRILLIANT CHROME    WHITE

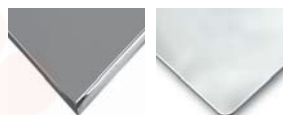





© 2014  
SPOCK - T









1 x 57 W CLASSIC P ECO E-27

1 x 22 W E-27

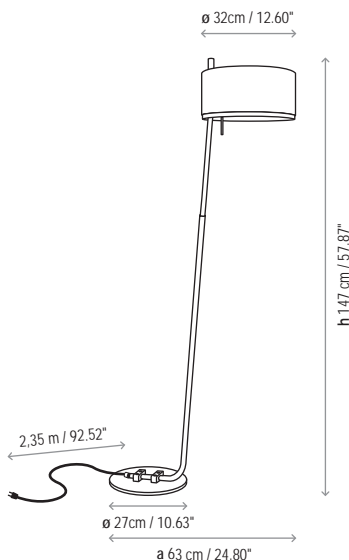

3132812 NEGRO MATE-NÍQUEL / MATTE BLACK-NICKEL

**PANTALLA / LAMPSHADE**

Pantalla aluminio negro  
*Black aluminum shade*  
Interior PVC blanco B1 Flame Resistant  
*White PVC interior B1 Flame Resistant*  
Incluye difusor superior de aluminio  
*Included aluminum top diffuser*

Interruptor en portalámparas  
*Lampholder switch*



**FAMILIA / FAMILY**

påg70 70 106 162 178

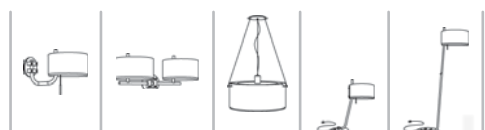

**ACABADOS / FINISHING**

NÍQUEL SATINADO SATIN NICKEL      NEGRO MATE MATTE BLACK

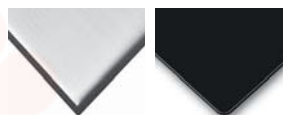





3 x 57 W CLASSIC A ECO E-27

3 x 18 W E-27  
Osram Dulux Intelligent dimmable

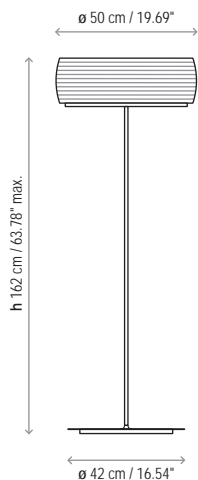

### CONTEMPORÁNEO / PIE CONTEMPORARY / FLOOR

3020205 NÍQUEL-CRISTAL OPAL GRABADO  
NICKEL-OPAL GLASS

3020206 CROMO-CRISTAL OPAL GRABADO  
CHROME-OPAL GLASS

Lámpara con dimmer incorporado / Lamp with incorporated dimmer

Debido a la naturaleza del cristal soplado, pueden aparecer pequeñas burbujas o variaciones que no se consideran defectos.

*Due to the nature of the hand blown cristal, natural variations should be expected and will not be considered an imperfection.*

### FAMILIA / FAMILY

pàg 124 164 180

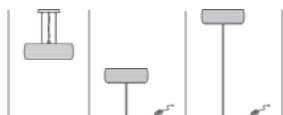

### ACABADOS / FINISHING

NÍQUEL SATINADO  
SATIN NICKEL

CROMO BRILLANTE  
BRILLIANT CHROME

CRISTAL OPAL GRABADO  
OPAL GLASS

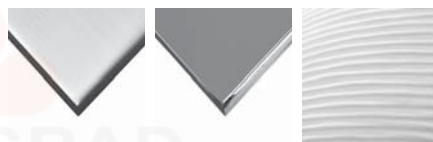





# SPOCK

DESIGN: CHRISTOPHE MATHIEU 2007

**CONTEMPORÁNEO / PIE**  
**CONTEMPORARY / FLOOR**



3,6 W LED | Led 12 x 0,3 W = 3,6 W Osram  
Lumens 444 lm @80°C  
Valor cromático / CRI 85  
Grados Kelvin  
Degrees Kelvin 3000°

DRIVE CONECTOR

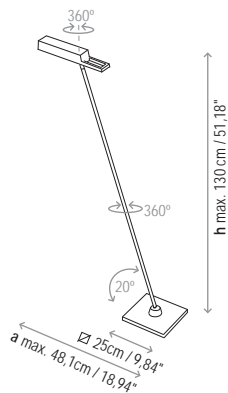
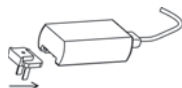

3110512L LED CROMO / LED CHROME  
3110511L LED CROMO-BLANCO / LED CHROME-WHITE

Pantalla de inyección de zamac orientable / Zamac injected orientable hood  
Base de acero inoxidable / Stainless steel base

DIFUSOR: Rotación circular 360°  
DIFFUSER: Circular rotation 360°

MÁSTIL: Rotación circular 360° / Inclinación mástil 20°  
MAST: Circular rotation 360° / Mast inclination 20°

## FAMILIA / FAMILY

pàg 92      174      174      182



## ACABADOS / FINISHING

CROMO BRILLANTE      BLANCO  
BRILLIANT CHROME      WHITE

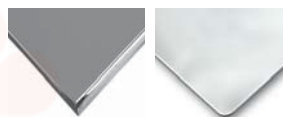







# PEANA

DESIGN: CARLES RIART / LLUÍS PORQUERAS 2005

CONTEMPORÁNEO / PIE  
CONTEMPORARY / FLOOR

## PEANA - 01 FONDA EUROPA

PEANA LUMINOSA / TABLE LIGHT

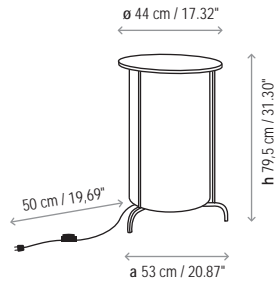
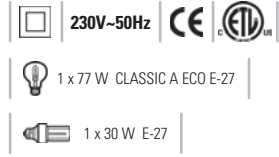

- 0124701 CROMO - LACADO BLANCO / CHROME - WHITE LACQUER
- 0124705 CROMO - MADERA NATURAL / CHROME - NATURAL WOOD
- 0124704 CROMO - MADERA WENGUÉ / CHROME - WENGUE WOOD

Pantalla 30 x 66 cm / Lampshade 11.81" x 25.98"

P-519 COTONET BLANCO / WHITE COTTON

HASTA AGOTAR EXISTENCIAS / TO BE DISCONTINUED. AVAILABLE UNTIL END OF STOCKS

## PEANA - 02 FONDA EUROPA

PEANA LUMINOSA / TABLE LIGHT

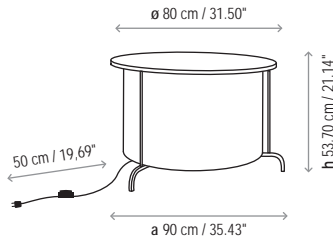
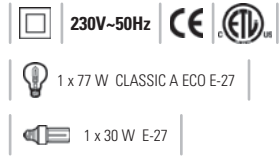

- 0224701 CROMO - LACADO BLANCO / CHROME - WHITE LACQUER
- 0224705 CROMO - MADERA NATURAL / CHROME - NATURAL WOOD
- 0224704 CROMO - MADERA WENGUÉ / CHROME - WENGUE WOOD

Pantalla 44 x 68 cm / Lampshade 17.32" x 26.77"

P-540 COTONET BLANCO / WHITE COTTON

## PEANA - 03 FONDA EUROPA

PEANA LUMINOSA / TABLE LIGHT

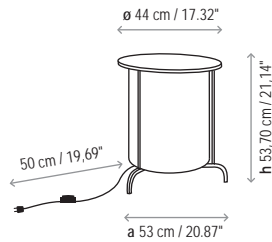
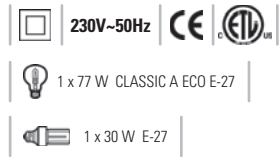

- 0324701 CROMO - LACADO BLANCO / CHROME - WHITE LACQUER
- 0324705 CROMO - MADERA NATURAL / CHROME - NATURAL WOOD
- 0324704 CROMO - MADERA WENGUÉ / CHROME - WENGUE WOOD

Pantalla 30 x 40 cm / Lampshade 11.81" x 15.75"

P-543 COTONET BLANCO / WHITE COTTON



### ACABADOS / FINISHING

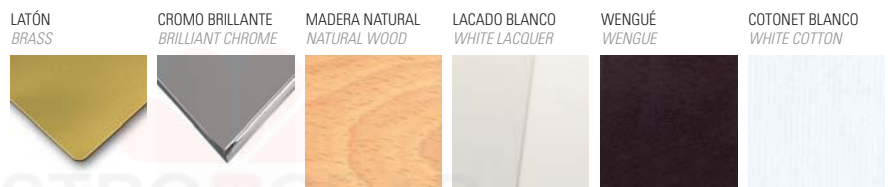













# CINTA *RIBBON*







1 x 46 W CLASSIC P ECO E-27

1 x 11 W E-27

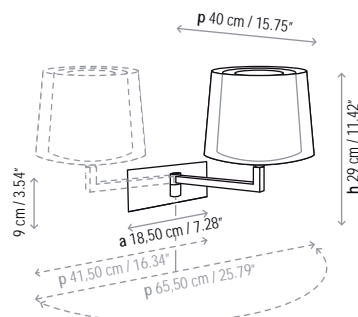

## CINTA / APLIQUE RIBBON / WALL LAMP

- 1132105 NÍQUEL SATINADO / SATIN NICKEL
- 1132106 CROMO BRILLANTE / BRILLIANT CHROME

Pantalla Exterior : 22 x 16 x 18 cm / Outer lampshade: 8.66" x 6.30" x 7.09"

- P-633E\* COTONET BLANCO / WHITE COTTON
- P-634E CINTA TRANSLÚCIDA BLANCA / WHITE TRANSLUCENT RIBBON
- P-635E CINTA TRANSLÚCIDA CREMA / CREAM TRANSLUCENT RIBBON
- P-636E\*\* NEGRO / BLACK MESH
- P-637E\*\* ROJO / RED MESH

\* Pantalla algodón sin tapa superior / Cotton shade without upper diffuser  
 \*\* Exterior pantalla de PVC cristal / Outer lampshade: PVC cristal

Pantalla Interior / Inner lampshade

- P-636I\*\*\* NEGRO / BLACK MESH
- P-637I\*\*\* ROJO / RED MESH

\*\*\* Interior pantalla film poliéster rígido resistente al calor  
 Inner shade made of a fireresistent polyester rigid film

Brazo móvil / Swivel arm

Caja soporte: 17x 8 cm / Surface back box: 6.69" x 3.15"

### ACABADOS / FINISHING

NÍQUEL SATINADO  
SATIN NICKEL

CROMO BRILLANTE  
BRILLIANT CHROME

MALLA NEGRA  
BLACK MESH

MALLA ROJA  
RED MESH

CINTA CREMA  
CREAM RIBBON

CINTA BLANCA  
WHITE RIBBON

COTONET BLANCO  
WHITE COTTON





# CARLOTA

DESIGN: JOANA BOVER 2003

## CARLOTA

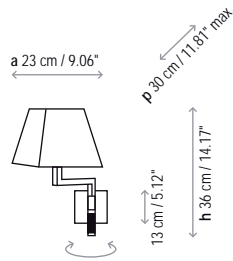

## CARLOTA - G

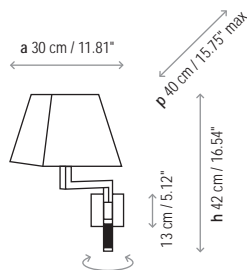

## CARLOTA DOBLE ARTICULADO

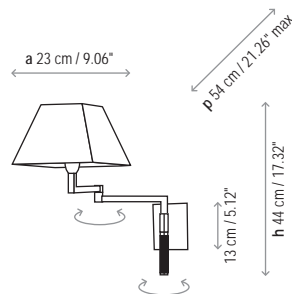

### FAMILIA / FAMILY

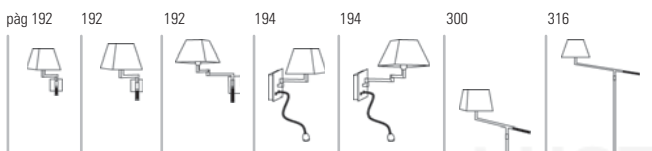

### CINTA / APLIQUE RIBBON / WALL LAMP

- 1024005 NÍQUEL SATINADO / SATIN NICKEL
- 1024006 CROMO BRILLANTE / BRILLIANT CHROME
- 1024060 NÍQUEL PIEL OSCURA / NICKEL DARK LEATHER
- 1024061 NÍQUEL PIEL CLARA / NICKEL CARAMEL LEATHER

Pantalla cuadrada 20 x 15 x 10 cm / Square lampshade 7.87" x 5.91" x 3.94"

- P-107 COTONET / COTTON
- P-202 CINTA TRANSLÚCIDA BLANCA / WHITE TRANSLUCENT RIBBON
- P-203 CINTA TRANSLÚCIDA CREMA / CREAM TRANSLUCENT RIBBON

Caja soporte  11 cm / Surface back box  4.33"  
Braza móvil / Swivel arm

- 1524005 NÍQUEL SATINADO / SATIN NICKEL
- 1524006 CROMO BRILLANTE / BRILLIANT CHROME
- 1524060 NÍQUEL PIEL OSCURA / NICKEL DARK LEATHER
- 1524061 NÍQUEL PIEL CLARA / NICKEL CARAMEL LEATHER

Pantalla cuadrada 23 x 17 x 12 cm / Square lampshade 9.06" x 6.69" x 4.72"

- P-487 COTONET / COTTON
- P-486 CINTA TRANSLÚCIDA BLANCA / WHITE TRANSLUCENT RIBBON
- P-489 CINTA TRANSLÚCIDA CREMA / CREAM TRANSLUCENT RIBBON

Caja soporte  11 cm / Surface back box  4.33"  
Braza móvil / Swivel arm

- 0924005 NÍQUEL SATINADO / SATIN NICKEL
- 0924006 CROMO BRILLANTE / BRILLIANT CHROME
- 0924060 NÍQUEL PIEL OSCURA / NICKEL DARK LEATHER
- 0924061 NÍQUEL PIEL CLARA / NICKEL CARAMEL LEATHER

Pantalla cuadrada 23 x 17 x 12 cm / Square lampshade 9.06" x 6.69" x 4.72"

- P-487 COTONET / COTTON
- P-486 CINTA TRANSLÚCIDA BLANCA / WHITE TRANSLUCENT RIBBON
- P-489 CINTA TRANSLÚCIDA CREMA / CREAM TRANSLUCENT RIBBON

Caja soporte  11 cm / Surface back box  4.33"  
Braza móvil / Swivel arm

### ACABADOS / FINISHING







# CARLOTA

DESIGN: JOANA BOVER 2003

## CARLOTA - G FL



1 x 46 W CLASSIC P ECO E-27

1 x 11 W E-27

1 x 1,2 W LED | Led 1,2 W Phillips  
Óptica / Optics 45°  
Lumens 85 lm  
Valor cromático / CRI 85  
Grados Kelvin / Degrees Kelvin 2900°

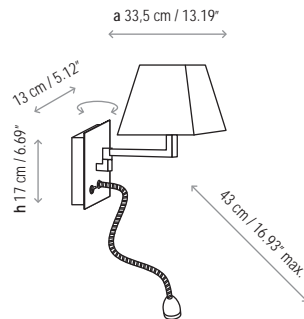

## CINTA / APLIQUE RIBBON / WALL LAMP

F524005 NÍQUEL SATINADO / SATIN NICKEL  
F524006 CROMO BRILLANTE / BRILLIANT CHROME  
F524060 NÍQUEL PIEL OSCURA / NICKEL DARK LEATHER  
F524061 NÍQUEL PIEL CLARA / NICKEL CAMEL LEATHER

Pantalla 23 x 17 x 12 cm / Lampshade 9.06" x 6.69" x 4.72"

P-487 COTONET / COTTON  
P-486 CINTA TRANSLÚCIDA BLANCA / WHITE TRANSLUCENT RIBBON  
P-489 CINTA TRANSLÚCIDA CREMA / CREAM TRANSLUCENT RIBBON

Caja soporte 11 x 15 cm / Surface back box 4.33" x 5.91"  
Brazo móvil / Swivel arm  
Flexo de latón para asegurar una mayor flexibilidad y rigidez  
Flexo made in brass to ensure greater flexibility and rigidity

## CARLOTA - DOBLE FL



1 x 46 W CLASSIC P ECO E-27

1 x 11 W E-27

1 x 1,2 W LED | Led 1,2 W Phillips  
Óptica / Optics 45°  
Lumens 85 lm  
Valor cromático / CRI 85  
Grados Kelvin / Degrees Kelvin 2900°

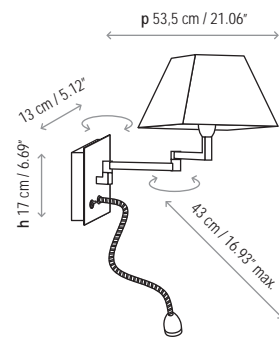

F924005 NÍQUEL SATINADO / SATIN NICKEL  
F924006 CROMO BRILLANTE / BRILLIANT CHROME  
F924060 NÍQUEL PIEL OSCURA / NICKEL DARK LEATHER  
F924061 NÍQUEL PIEL CLARA / NICKEL CAMEL LEATHER

Pantalla 23 x 17 x 12 cm / Lampshade 9.06" x 6.69" x 4.72"

P-487 COTONET / COTTON  
P-486 CINTA TRANSLÚCIDA BLANCA / WHITE TRANSLUCENT RIBBON  
P-489 CINTA TRANSLÚCIDA CREMA / CREAM TRANSLUCENT RIBBON

Caja soporte 11 x 15 cm / Surface back box 4.33" x 5.91"  
Brazo móvil / Swivel arm  
Flexo de latón para asegurar una mayor flexibilidad y rigidez  
Flexo made in brass to ensure greater flexibility and rigidity

## ACABADOS / FINISHING

COTONET COTTON | CINTA CREMA CREAM RIBBON | CINTA BLANCA WHITE RIBBON



NÍQUEL SATINADO SATIN NICKEL | CROMO BRILLANTE BRILLIANT CHROME | PIEL OSCURA DARK LEATHER | PIEL CLARA CAMEL LEATHER

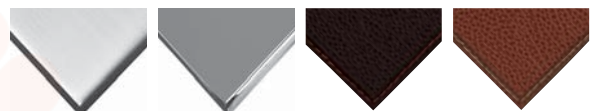

## FAMILIA / FAMILY

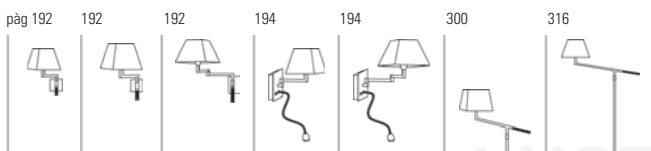







1 x 46 W CLASSIC P ECO E-27

1 x 11 W E-27

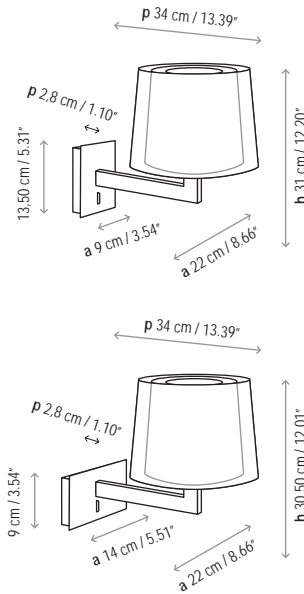

**CINTA / APLIQUE**  
**RIBBON / WALL LAMP**

Caja vertical 9 x 13,5 cm / Vertical Backplate-box 3.54" x 5.31"

- 1120505 NÍQUEL SATINADO / SATIN NICKEL
- 1120506 CROMO BRILLANTE / BRILLIANT CHROME
- 1120508 CROMO-NEGRO / BLACK CHROME

Caja horizontal 14 x 9 cm / Horizontal Backplate-box 5.51" x 3.54"

- 1320505 NÍQUEL SATINADO / SATIN NICKEL
- 1320506 CROMO BRILLANTE / BRILLIANT CHROME
- 1320508 CROMO-NEGRO / BLACK CHROME

Pantalla exterior 22 x 16 x 18 cm / Outer lampshade 8.66" x 6.30" x 7.09"

- P-633E\* COTONET BLANCO / WHITE COTTON
- P-634E CINTA TRANSLÚCIDA BLANCA / WHITE TRANSLUCENT RIBBON
- P-635E CINTA TRANSLÚCIDA CREMA / CREAM TRANSLUCENT RIBBON
- P-636E\*\* NEGRO / BLACK MESH
- P-637E\*\* ROJO / RED MESH

\* Pantalla algodón sin tapa superior / Cotton shade without upper diffuser  
\*\* Exterior pantalla de PVC cristal / Outer lampshade: PVC cristal

Pantalla interior / Inner lampshade

- P-636I\*\*\* NEGRO / BLACK MESH
- P-637I\*\*\* ROJO / RED MESH

\*\*\* Interior pantalla de film poliéster rígido resistente al calor  
Inner shade made of a fire-resistant polyester rigid film



**ACABADOS / FINISHING**

NÍQUEL SATINADO  
SATIN NICKEL

CROMO BRILLANTE  
BRILLIANT CHROME

CROMO NEGRO  
BLACK CHROME

MALLA NEGRA  
BLACK MESH

MALLA ROJA  
RED MESH

CINTA CREMA  
CREAM RIBBON

CINTA BLANCA  
WHITE RIBBON

COTONET BLANCO  
WHITE COTTON

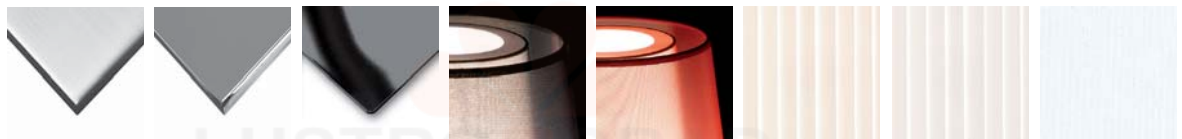



# LEXA - FL

DESIGN: JOANA BOVER / CHRISTOPHE MATHIEU 2008



1 x 46 W CLASSIC P ECO E-27

1 x 11 W E-27

1 x 1,2 W LED  
 Led 1,2 W Phillips  
 Óptica / Optics 45°  
 Lumens 85 lm  
 Valor cromático / CRI 85  
 Grados Kelvin / Degrees Kelvin 2900°

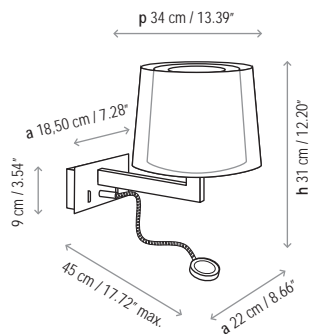
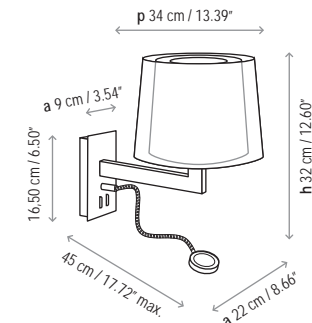

## CINTA / APLIQUE RIBBON / WALL LAMP

Caja vertical 9 x 16,5 cm / Vertical Backplate-box 3.54" x 6.50"

- 1220505 NÍQUEL SATINADO / SATIN NICKEL
- 1220506 CROMO BRILLANTE / BRILLIANT CHROME
- 1220508 CROMO-NEGRO / BLACK CHROME

Caja horizontal 18,50 x 9 cm / Horizontal Backplate-box 7.28" x 3.54"

- 1020505 NÍQUEL SATINADO / SATIN NICKEL
- 1020506 CROMO BRILLANTE / BRILLIANT CHROME
- 1020508 CROMO-NEGRO / BLACK CHROME

Flexo realizado en latón para mayor flexibilidad y garantía de rigidez. Cabezal de inyección de Zamac, interruptores de encendido en la base  
 Flexo made in brass to ensure greater flexibility and rigidity, with Zamac injection. Hood and switch on back plate.

Pantalla exterior 22 x 16 x 18 cm / Outer lampshade 8.66" x 6.30" x 7.09"

- P-633E\* COTONET BLANCO / WHITE COTTON
- P-634E CINTA TRANSLÚCIDA BLANCA / WHITE TRANSLUCENT RIBBON
- P-635E CINTA TRANSLÚCIDA CREMA / CREAM TRANSLUCENT RIBBON
- P-636E\*\* NEGRO / BLACK MESH
- P-637E\*\* ROJO / RED MESH

\* Pantalla algodón sin tapa superior / Cotton shade without upper diffuser  
 \*\* Exterior pantalla de PVC cristal / Outer lampshade: PVC cristal

Pantalla interior / Inner lampshade

- P-6361\*\*\* NEGRO / BLACK MESH
- P-6371\*\*\* ROJO / RED MESH

\*\*\* Interior pantalla de film poliéster rígido resistente al calor  
 Inner shade made of a fire-resistant polyester rigid film



### ACABADOS / FINISHING

NÍQUEL SATINADO  
 SATIN NICKEL

CROMO BRILLANTE  
 BRILLIANT CHROME

CROMO NEGRO  
 BLACK CHROME

MALLA NEGRA  
 BLACK MESH

MALLA ROJA  
 RED MESH

CINTA CREMA  
 CREAM RIBBON

CINTA BLANCA  
 WHITE RIBBON

COTONET BLANCO  
 WHITE COTTON

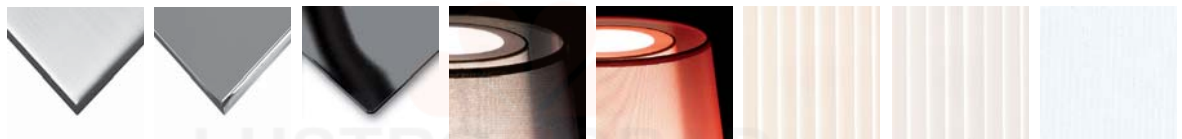





# MEI OVAL

DESIGN: JOANA BOVER 2007

## MEI OVAL - 01



1 x 46 W CLASSIC P ECO E-27

1 x 11 W E-27  
Duluxstar Mini Twist

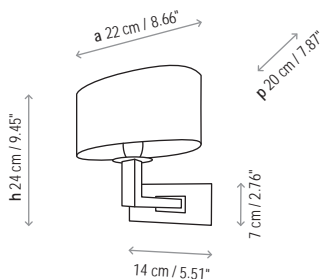

### CINTA / APLIQUE RIBBON / WALL LAMP

- 0125005 NÍQUEL SATINADO / SATIN NICKEL
- 0125006 CROMO BRILLANTE / BRILLIANT CHROME
- 0125060 NÍQUEL PIEL OSCURA / NICKEL DARK LEATHER
- 0125061 NÍQUEL PIEL CLARA / NICKEL CARAMEL LEATHER
- 0125017 CROMO CRISTAL NEGRO / CHROME BLACK GLASS

Pantalla oval 21 x 14 x 13 cm / Oval lampshade 8.27" x 5.51" x 5.12"

- P-600 CINTA TRANSLÚCIDA BLANCA / WHITE TRANSLUCENT RIBBON
- P-601 CINTA TRANSLÚCIDA CREMA / CREAM TRANSLUCENT RIBBON
- P-602 CINTA TRANSLÚCIDA NEGRA / BLACK TRANSLUCENT RIBBON
- P-603 COTONET BLANCO / WHITE COTTON

## MEI OVAL - 02



1 x 46 W CLASSIC P ECO E-27

1 x 11 W E-27  
Duluxstar Mini Twist

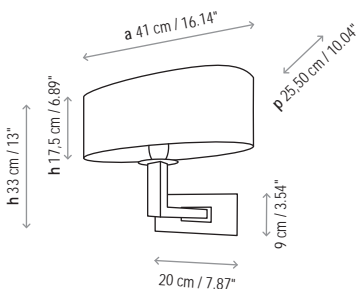

- 1125005 NÍQUEL SATINADO / SATIN NICKEL
- 1125006 CROMO BRILLANTE / BRILLIANT CHROME
- 1125060 NÍQUEL PIEL OSCURA / NICKEL DARK LEATHER
- 1125061 NÍQUEL PIEL CLARA / NICKEL CARAMEL LEATHER
- 1125017 CROMO CRISTAL NEGRO / CHROME BLACK GLASS

Pantalla oval 41 x 17,5 x 15 cm / Oval lampshade 16.14" x 6.89" x 5.91"

La pantalla con difusor solo admite bombillas ECO-CLASSIC. NO son aptas las bombillas compactas.

Shade with upper diffuser can only go with ECO-CLASSIC bulbs. NOT suitable with compact bulbs.

- P-551 CINTA TRANSLÚCIDA BLANCA / WHITE TRANSLUCENT RIBBON
- P-552 CINTA TRANSLÚCIDA CREMA / CREAM TRANSLUCENT RIBBON
- P-553 CINTA TRANSLÚCIDA NEGRA / BLACK TRANSLUCENT RIBBON
- P-554 COTONET BLANCO / WHITE COTTON

La pantalla estándar no incluye difusor negro de cristal. Véase pantalla Mei Oval mesa.  
Standard shade does not include the black glass diffuser. See Mei Oval mesa shade for reference.

### ACABADOS / FINISHING

CINTA CREMA / CREAM RIBBON      CINTA BLANCA / WHITE RIBBON      CINTA NEGRA / BLACK RIBBON      COTONET BLANCO / WHITE COTTON



NÍQUEL SATINADO / SATIN NICKEL      CROMO BRILLANTE / BRILLIANT CHROME      CRISTAL NEGRO / BLACK GLASS      PIEL OSCURA / DARK LEATHER      PIEL CLARA / CARAMEL LEATHER



### FAMILIA / FAMILY

pàg 200    200    248    310    310    310    324











# SILANTRA

DESIGN: CHRISTOPHE MATHIEU 2004

## SILANTRA - 01

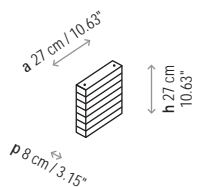
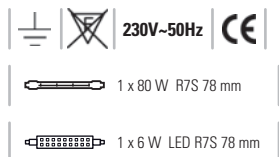

## SILANTRA - 02

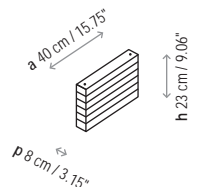
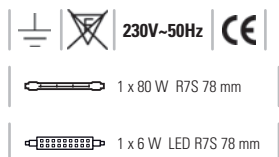

## SILANTRA - 03

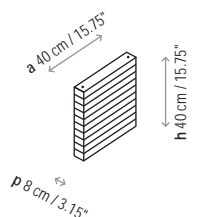
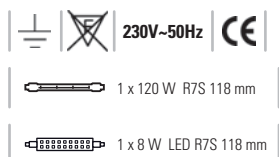

## CINTA / APLIQUE RIBBON / WALL LAMP

1245525 ALUMINIO PULIDO-CINTA TRANSLÚCIDA CREMA  
POLISHED ALUMINIUM-CREAM TRANSLUCENT RIBBON

1245526 ALUMINIO PULIDO-CINTA TRANSLÚCIDA BLANCA  
POLISHED ALUMINIUM-WHITE TRANSLUCENT RIBBON

Pantalla 27 x 27 cm / Lampshade 10.63" x 10.63"

2245527 ALUMINIO PULIDO-CINTA TRANSLÚCIDA CREMA  
POLISHED ALUMINIUM-CREAM TRANSLUCENT RIBBON

2245528 ALUMINIO PULIDO-CINTA TRANSLÚCIDA BLANCA  
POLISHED ALUMINIUM-WHITE TRANSLUCENT RIBBON

Pantalla 40 x 23 cm / Lampshade 15.75" x 9.06"

H245529 ALUMINIO PULIDO-CINTA TRANSLÚCIDA CREMA  
(HALÓGENO)  
POLISHED ALUMINIUM-CREAM TRANSLUCENT RIBBON  
(HALOGEN)

H245530 ALUMINIO PULIDO-CINTA TRANSLÚCIDA BLANCA  
(HALÓGENO)  
POLISHED ALUMINIUM-WHITE TRANSLUCENT RIBBON  
(HALOGEN)

F245529 ALUMINIO PULIDO-CINTA TRANSLÚCIDA CREMA  
(FLUORESCENTE)  
POLISHED ALUMINIUM-CREAM TRANSLUCENT RIBBON  
(FLUORESCENT)

F245530 ALUMINIO PULIDO-CINTA TRANSLÚCIDA BLANCA  
(FLUORESCENTE)  
POLISHED ALUMINIUM-WHITE TRANSLUCENT RIBBON  
(FLUORESCENT)

Pantalla 40 x 40 cm / Lampshade 15.75" x 15.75"

(\* ) NO DIMABLE / NO DIMMABLE

## FAMILIA / FAMILY

pàg 204 204 204 206 206 206 262

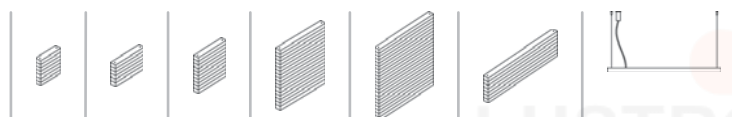

## ACABADOS / FINISHING

NÍQUEL SATINADO SATIN NICKEL CINTA CREMA CREAM RIBBON CINTA BLANCA WHITE RIBBON







# SILANTRA

DESIGN: CHRISTOPHE MATHIEU 2004

## SILANTRA - 04

APLIQUE - PLAFÓN / WALL LAMP - CEILING



4 x 24 W T5 fluorescente  
Reactancia electrónica  
Fluorescent  
electronic ballast

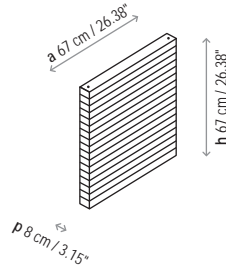

## SILANTRA - 05

APLIQUE - PLAFÓN / WALL LAMP - CEILING



4 x 39 W T5 fluorescente  
Reactancia electrónica  
Fluorescent  
electronic ballast

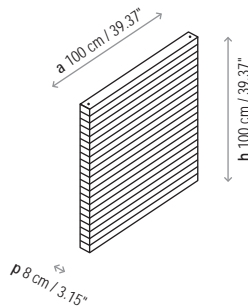

## SILANTRA - 06

APLIQUE - PLAFÓN / WALL LAMP - CEILING



2 x 39 W T5 fluorescente  
Reactancia electrónica  
Fluorescent  
electronic ballast

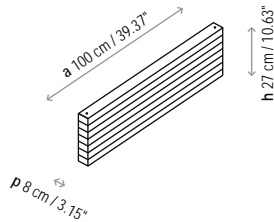

## CINTA / APLIQUE RIBBON / WALL LAMP

- 4245531 CINTA TRANSLÚCIDA CREMA  
CREAM TRANSLUCENT RIBBON
- 4245532 CINTA TRANSLÚCIDA BLANCA  
WHITE TRANSLUCENT RIBBON
- D4245531 REGULABLE SISTEMA DALI / CINTA TRANSLÚCIDA CREMA  
DALI DIMMING SYSTEM / CREAM TRANSLUCENT RIBBON
- D4245532 REGULABLE SISTEMA DALI / CINTA TRANSLÚCIDA BLANCA  
DALI DIMMING SYSTEM / WHITE TRANSLUCENT RIBBON

Aluminio pulido / Polished aluminium  
Pantalla 67 x 67 cm / Lampshade 26.38" x 26.38"

- 5245533 CINTA TRANSLÚCIDA CREMA  
CREAM TRANSLUCENT RIBBON
- 5245534 CINTA TRANSLÚCIDA BLANCA  
WHITE TRANSLUCENT RIBBON
- D5245533 REGULABLE SISTEMA DALI / CINTA TRANSLÚCIDA CREMA  
DALI DIMMING SYSTEM / CREAM TRANSLUCENT RIBBON
- D5245534 REGULABLE SISTEMA DALI / CINTA TRANSLÚCIDA BLANCA  
DALI DIMMING SYSTEM / WHITE TRANSLUCENT RIBBON

Aluminio pulido / Polished aluminium  
Pantalla 100 x 100 cm / Lampshade 39.37" x 39.37"

- 6245535 CINTA TRANSLÚCIDA CREMA  
CREAM TRANSLUCENT RIBBON
- 6245536 CINTA TRANSLÚCIDA BLANCA  
WHITE TRANSLUCENT RIBBON
- D6245535 REGULABLE SISTEMA DALI / CINTA TRANSLÚCIDA CREMA  
DALI DIMMING SYSTEM / CREAM TRANSLUCENT RIBBON
- D6245536 REGULABLE SISTEMA DALI / CINTA TRANSLÚCIDA BLANCA  
DALI DIMMING SYSTEM / WHITE TRANSLUCENT RIBBON

Aluminio pulido / Polished aluminium  
Pantalla 100 x 27 cm / Lampshade 39.37" x 10.63"

## FAMILIA / FAMILY

pàg 204 204 204 206 206 206 262

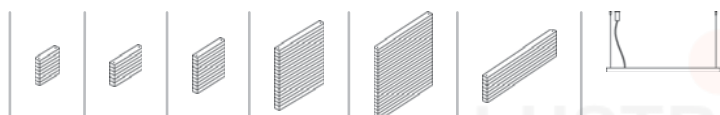

## ACABADOS / FINISHING

NIQUEL SATINADO SATIN NICKEL CINTA CREMA CREAM RIBBON CINTA BLANCA WHITE RIBBON











# WALL STREET - FL

DESIGN: JOANA BOVER 2010

## CINTA / APLIQUE RIBBON / WALL LAMP

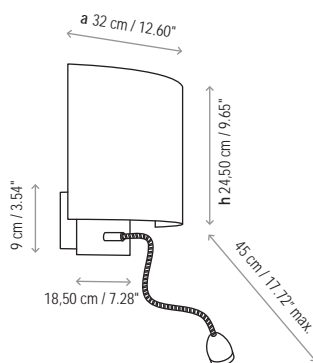

- 1118505FL NIQUEL SATINADO / SATIN NICKEL
- 1118506FL CROMO BRILLANTE / BRILLIANT CHROME

Pantalla 32 x 20 cm / lampshade 12.60" x 7.87"

- P-338 PLISADA / PLEATED
- P-339 COTONET / COTTON
- P-332 COTONET BLANCO / WHITE COTTON
- P-333 CINTA TRANSLÚCIDA CREMA / CREAM TRANSLUCENT RIBBON
- P-334 CINTA TRANSLÚCIDA BLANCA / WHITE TRANSLUCENT RIBBON

Caja soporte: 17 x 7.5 cm / Surface back box: 6.69" x 2.95"  
Flexo de latón para asegurar una mayor flexibilidad y rigidez  
Flexo made in brass to ensure greater flexibility and rigidity

### ACABADOS / FINISHING

NIQUEL SATINADO  
SATIN NICKEL

CROMO BRILLANTE  
BRILLIANT CHROME

PLISADA  
PLEATED

COTONET  
COTTON

COTONET BLANCO  
WHITE COTTON

CINTA CREMA  
CREAM RIBBON

CINTA BLANCA  
WHITE RIBBON

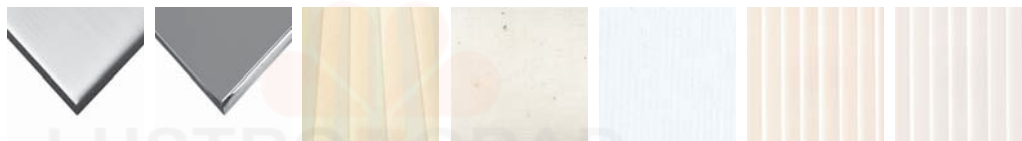





# 212 WALL STREET

DESIGN: JOANA BOVER 2000



1 x 30 W CLASSIC P ECO E-27

1 x 14 W E-27

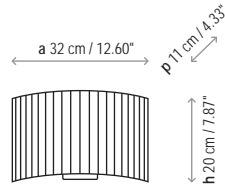
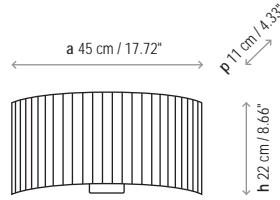

1 x 30 W CLASSIC P ECO E-27

1 x 8 W E-27  
Duluxstar Mini Twist

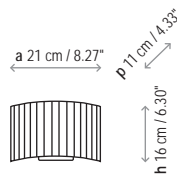

## CINTA / APLIQUE RIBBON / WALL LAMP

- 1118505 NÍQUEL SATINADO / SATIN NICKEL
- 1118504 HIERRO NEGRO / BLACK IRON
- 1118503 HIERRO MARRÓN GRAFITO / GRAPHITE BROWN IRON:::

Caja soporte 8 x 5 cm / Surface back box 3.15" x 1.97"

Pantalla 45 x 22 cm / Lampshade 17.72" x 8.66"

- P-295 PLISADA / PLEATED
- P-296 COTONET / COTTON
- P-297 COTONET BLANCO / WHITE COTTON
- P-298 CINTA TRANSLÚCIDA CREMA / CREAM TRANSLUCENT RIBBON
- P-299 CINTA TRANSLÚCIDA BLANCA / WHITE TRANSLUCENT RIBBON

Pantalla 32 x 20 cm / Lampshade 12.60" x 7.87"

- P-338 PLISADA / PLEATED
- P-339 COTONET / COTTON
- P-332 COTONET BLANCO / WHITE COTTON
- P-333 CINTA TRANSLÚCIDA CREMA / CREAM TRANSLUCENT RIBBON
- P-334 CINTA TRANSLÚCIDA BLANCA / WHITE TRANSLUCENT RIBBON

Pantalla 21 x 16 cm / Lampshade 8.27" x 6.30"

- P-346 PLISADA / PLEATED
- P-347 COTONET / COTTON
- P-342 COTONET BLANCO / WHITE COTTON
- P-355 CINTA TRANSLÚCIDA CREMA / CREAM TRANSLUCENT RIBBON
- P-356 CINTA TRANSLÚCIDA BLANCA / WHITE TRANSLUCENT RIBBON

## ACABADOS / FINISHING

NÍQUEL SATINADO  
SATIN NICKEL

HIERRO MARRÓN  
BROWN IRON

HIERRO NEGRO  
BLACK IRON

PLISADA  
PLEATED

COTONET  
COTTON

COTONET BLANCO  
WHITE COTTON

CINTA CREMA  
CREAM RIBBON

CINTA BLANCA  
WHITE RIBBON







# WALL STREET T5

DESIGN: JOANA BOVER 2008

**CINTA / APLIQUE**  
**RIBBON / WALL LAMP**

## WALL STREET T5 - 01

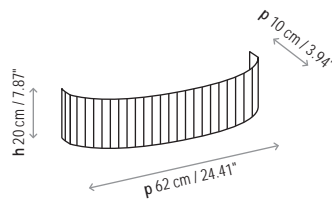
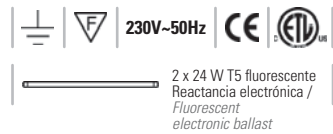

T529001 ESTRUCTURA BLANCA T-5/01 / WHITE STRUCTURE T-5/01

Pantalla T-5/01 / Lampshade T-5/01

- P-605 COTONET BLANCO / WHITE COTTON
- P-606 CINTA TRANSLÚCIDA BLANCA / WHITE TRANSLUCENT RIBBON
- P-607 CINTA TRANSLÚCIDA CREMA / CREAM TRANSLUCENT RIBBON

Las medidas de este aplique van siempre en función de los fluorescentes T-5 HO  
Wall lamp measures are according to T-5 HO Fluorescents

## WALL STREET T5 - 02

**BIG FORMAT**

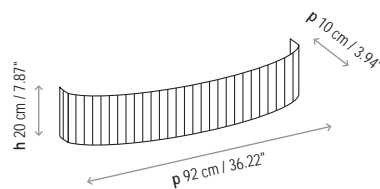
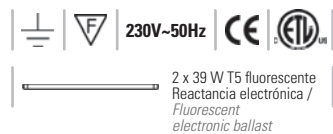

T529002 ESTRUCTURA BLANCA T-5/02 / WHITE STRUCTURE T-5/02

Pantalla T-5/02 / Lampshade T-5/02

- P-611 COTONET BLANCO / WHITE COTTON
- P-612 CINTA TRANSLÚCIDA BLANCA / WHITE TRANSLUCENT RIBBON
- P-613 CINTA TRANSLÚCIDA CREMA / CREAM TRANSLUCENT RIBBON

Las medidas de este aplique van siempre en función de los fluorescentes T-5 HO  
Wall lamp measures are according to T-5 HO Fluorescents



### ACABADOS / FINISHING

- COTONET BLANCO / WHITE COTTON
- CINTA CREMA / CREAM RIBBON
- CINTA BLANCA / WHITE RIBBON





# CORNELIA

DESIGN: JOANA BOVER 2013

## CORNELIA - 02

**BIG FORMAT**

230V-50Hz



8 x 46 W CLASSIC P ECO E-27

8 x 14 W E-27

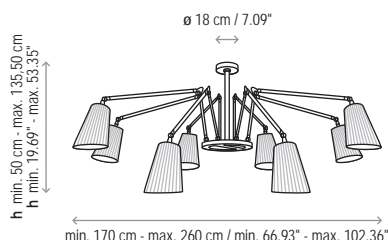

### CINTA / SUSPENSIÓN RIBBON / PENDANT LAMP

- 2620210041 BLANCO - LATÓN PULIDO / WHITE - POLISHED BRASS
- 2620210044 BLANCO - CROMO / WHITE - CHROME
- 2620210045 NEGRO - LATÓN PULIDO / BLACK - POLISHED BRASS
- 2620210042 NEGRO - CROMO / BLACK - CHROME
- 2620210046 ROJO - LATÓN PULIDO / RED - POLISHED BRASS
- 2620210043 ROJO - CROMO / RED - CHROME

Los difusores están incluidos en el precio de la luminaria

*Diffusers are included on the price of the luminarie*

La estructura negra/roja incluye el difusor negro

*Black/red fitting includes black diffuser*

La estructura blanca incluye el difusor blanco

*White fitting includes white diffuser*

Pantallas cónicas 18,5 x 26,5 x 10 cm

*Cone-shaped shades 7.28" x 10.43" x 3.94"*

- P-776 CINTA TRANSLÚCIDA BLANCA / WHITE TRANSLUCENT RIBBON
- P-777 CINTA TRANSLÚCIDA CREMA / CREAM TRANSLUCENT RIBBON
- P-781 CINTA TRANSLÚCIDA ROJA / RED TRANSLUCENT RIBBON
- P-782 COTONET BLANCO / WHITE COTTON
- P-778 COTONET NEGRO / BLACK COTTON
- P-779 BLANCO-INTERIOR NARANJA / WHITE FABRIC-ORANGE INSIDE
- P-780 NEGRO - INTERIOR NARANJA / BLACK FABRIC-ORANGE INSIDE
- P-783 NEGRO - INTERIOR ORO / BLACK FABRIC-GOLD INSIDE
- P-784 NEGRO - INTERIOR PLATA / BLACK FABRIC-SILVER INSIDE

## CORNELIA - 03

**BIG FORMAT**

230V-50Hz



12 x 46 W CLASSIC P ECO E-27

12 x 14 W E-27

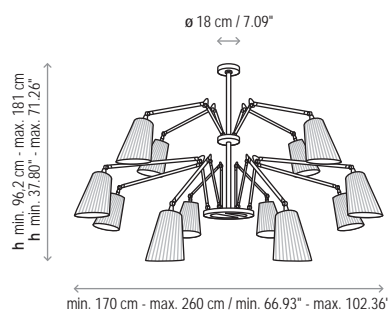

- 2620310041 BLANCO - LATÓN PULIDO / WHITE - POLISHED BRASS
- 2620310044 BLANCO - CROMO / WHITE - CHROME
- 2620310045 NEGRO - LATÓN PULIDO / BLACK - POLISHED BRASS
- 2620310042 NEGRO - CROMO / BLACK - CHROME
- 2620310046 ROJO - LATÓN PULIDO / RED - POLISHED BRASS
- 2620310043 ROJO - CROMO / RED - CHROME

Los difusores están incluidos en el precio de la luminaria

*Diffusers are included on the price of the luminarie*

La estructura negra/roja incluye el difusor negro

*Black/red fitting includes black diffuser*

La estructura blanca incluye el difusor blanco

*White fitting includes white diffuser*

Pantallas cónicas 18,5 x 26,5 x 10 cm

*Cone-shaped shades 7.28" x 10.43" x 3.94"*

- P-776 CINTA TRANSLÚCIDA BLANCA / WHITE TRANSLUCENT RIBBON
- P-777 CINTA TRANSLÚCIDA CREMA / CREAM TRANSLUCENT RIBBON
- P-781 CINTA TRANSLÚCIDA ROJA / RED TRANSLUCENT RIBBON
- P-782 COTONET BLANCO / WHITE COTTON
- P-778 COTONET NEGRO / BLACK COTTON
- P-779 BLANCO-INTERIOR NARANJA / WHITE FABRIC-ORANGE INSIDE
- P-780 NEGRO - INTERIOR NARANJA / BLACK FABRIC-ORANGE INSIDE
- P-783 NEGRO - INTERIOR ORO / BLACK FABRIC-GOLD INSIDE
- P-784 NEGRO - INTERIOR PLATA / BLACK FABRIC-SILVER INSIDE

### ACABADOS / FINISHING

COTONET NEGRO  
COTTON BLACK

COTONET BLANCO  
INTERIOR NARANJA  
COTTON WHITE  
ORANGE INSIDE

COTONET NEGRO  
INTERIOR NARANJA  
COTTON BLACK  
ORANGE INSIDE

COTONET NEGRO  
INTERIOR ORO  
COTTON BLACK  
GOLD INSIDE

COTONET NEGRO  
INTERIOR PLATA  
COTTON BLACK  
SILVER INSIDE

COTONET  
COTTON

CINTA CREMA  
CREAM RIBBON

CINTA BLANCA  
WHITE RIBBON

CINTA ROJA  
RED RIBBON

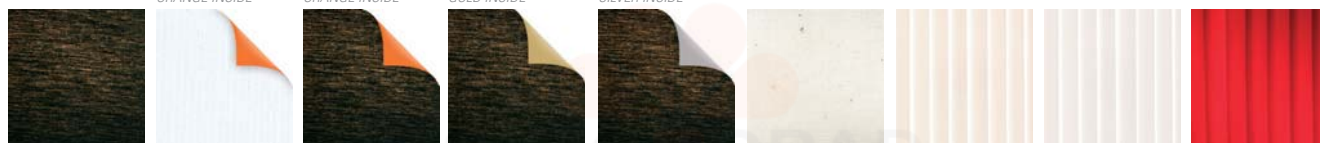





Custom product: "Shown here is custom length"  
Tarambana / Espai Gastronòmic / Cardedeu













# DANONA

DESIGN: JOANA BOVER 2002

## CINTA / SUSPENSIÓN RIBBON / PENDANT LAMP

### DANONA - 1 L



1 x 77 W CLASSIC A ECO E-27

1 x 18 W E-27

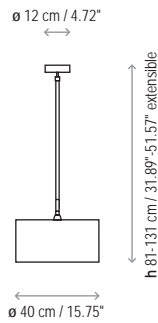

- 4123105 NÍQUEL SATINADO / SATIN NICKEL
- 4123160 NÍQUEL PIEL OSCURA / NICKEL DARK LEATHER
- 4123161 NÍQUEL PIEL CLARA / NICKEL CARAMEL LEATHER

Pantalla 40 x 22 x 40 cm / Lampshade 15.75" x 8.66" x 15.75"

- P-416 COTONET / COTTON
- P-420 CINTA TRANSLÚCIDA BLANCA / WHITE TRANSLUCENT RIBBON
- P-421 CINTA TRANSLÚCIDA CREMA / CREAM TRANSLUCENT RIBBON

Pantalla con difusor superior / The shade includes upper diffuser

### DANONA - 3 L



3 x 77 W CLASSIC A ECO E-27

3 x 18 W E-27

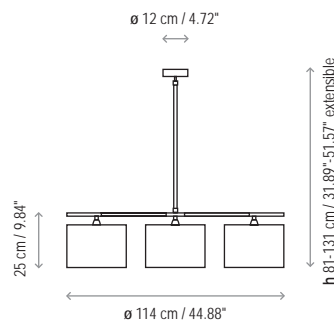

- 4323105 NÍQUEL SATINADO / SATIN NICKEL
- 4323160 NÍQUEL PIEL OSCURA / NICKEL DARK LEATHER
- 4323161 NÍQUEL PIEL CLARA / NICKEL CARAMEL LEATHER

Pantalla 27 x 18 x 27 cm Precio unitario / Lampshade 10.63" x 7.09" x 10.63"  
Unitary price

- P-150 COTONET / COTTON
- P-005C CINTA TRANSLÚCIDA CREMA / CREAM TRANSLUCENT RIBBON
- P-006C CINTA TRANSLÚCIDA BLANCA / WHITE TRANSLUCENT RIBBON



#### FAMILIA / FAMILY

pàg 222 222 302 302 318



#### ACABADOS / FINISHING

NÍQUEL SATINADO SATIN NICKEL    PIEL OSCURA DARK LEATHER    PIEL CLARA CARAMEL LEATHER    COTONET COTTON    CINTA CREMA CREAM RIBBON    CINTA BLANCA WHITE RIBBON







# LÁMPARA XVIII

DESIGN: JOANA BOVER 1998

## CINTA / SUSPENSIÓN RIBBON / PENDANT LAMP



18 x 46 W CLASSIC P ECO E-27

18 x 11 W E-27

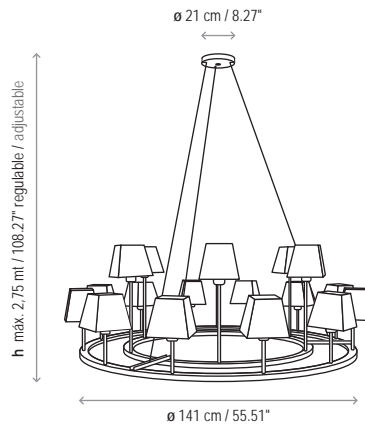

4610306 GRIS PLATA-CROMO / GREY SILVER-CHROME  
4610304 MARRÓN GRAFITO-NÍQUEL / GRAPHITE BROWN-NICKEL

Lámpara con 2 encendidos / With 2 lighting-mood positions  
Altura regulable / Adjustable height  
Cable tensor con rótulas interiores regulables para un correcto y fácil posicionamiento de la luminaria  
For easier installation, available with tensor wires including interior ball-and-socket joints  
Conexión manguera algodón gris plata / Silver wire

Pantallas cuadradas 15 x 13 x 10 cm  
Square lampshades 5.91" x 5.12" x 3.94"

P-640 COTONET BLANCO / WHITE COTTON  
P-641 CINTA TRANSLÚCIDA BLANCA / WHITE TRANSLUCENT RIBBON  
P-642 CINTA TRANSLÚCIDA CREMA / CREAM TRANSLUCENT RIBBON  
P-643 CINTA TRANSLÚCIDA ROJA / RED TRANSLUCENT RIBBON

Pantallas cónicas 18 x 15 x 12 cm  
Cone-shaped shades 7.09" x 5.91" x 4.72"

P-750 COTONET / COTTON  
P-751 CINTA TRANSLÚCIDA BLANCA / WHITE TRANSLUCENT RIBBON  
P-752 CINTA TRANSLÚCIDA CREMA / CREAM TRANSLUCENT RIBBON  
P-753 CINTA TRANSLÚCIDA ROJA / RED TRANSLUCENT RIBBON



### ACABADOS / FINISHING

MARRÓN GRAFITO  
GRAPHITE BROWN

GRIS PLATA  
GRAY SILVER

NÍQUEL SATINADO  
SATIN NICKEL

CROMO BRILLANTE  
BRILLIANT CHROME

COTONET  
COTTON

CINTA CREMA  
CREAM RIBBON

CINTA BLANCA  
WHITE RIBBON

CINTA ROJA  
RED RIBBON













**CINTA / SUSPENSIÓN**  
**RIBBON / PENDANT LAMP**

**LUA - 1 L**

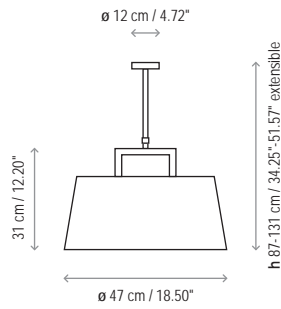

- 4122904 HIERRO NEGRO / BLACK IRON
- 4122905 NÍQUEL SATINADO / SATIN NICKEL
- 4122960 NÍQUEL PIEL OSCURA / NICKEL DARK LEATHER
- 4122961 NÍQUEL PIEL CLARA / NICKEL CAMEL LEATHER

Pantalla 47 x 21 x 40 cm / Lampshade 18.50" x 8.27" x 15.75"

- P-160C COTONET / COTTON
- P-183C CINTA TRANSLÚCIDA CREMA / CREAM TRANSLUCENT RIBBON
- P-184C CINTA TRANSLÚCIDA BLANCA / WHITE TRANSLUCENT RIBBON

\* Pantalla incluye difusor superior / The shade includes upper diffuser

**LUA - 2 L**

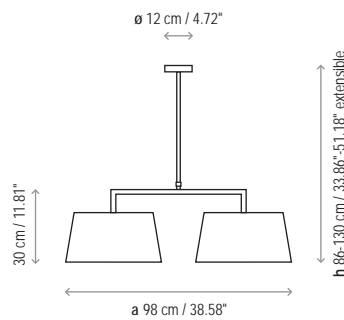

- 4222904 HIERRO NEGRO / BLACK IRON
- 4222905 NÍQUEL SATINADO / SATIN NICKEL
- 4222960 NÍQUEL PIEL OSCURA / NICKEL DARK LEATHER
- 4222961 NÍQUEL PIEL CLARA / NICKEL CAMEL LEATHER

Pantalla 38 x 20 x 30 Precio unitario  
Lampshade 14.96" x 7.87" x 11.81" Unitary price

- P-163C COTONET / COTTON
- P-167C CINTA TRANSLÚCIDA CREMA / CREAM TRANSLUCENT RIBBON
- P-168C CINTA TRANSLÚCIDA BLANCA / WHITE TRANSLUCENT RIBBON

\* Pantalla incluye difusor superior / The shade includes upper diffuser



**ACABADOS / FINISHING**

NÍQUEL SATINADO  
SATIN NICKEL

HIERRO NEGRO  
BLACK IRON

PIEL OSCURA  
DARK LEATHER

PIEL CLARA  
CAMEL LEATHER

COTONET  
COTTON

CINTA CREMA  
CREAM RIBBON

CINTA BLANCA  
WHITE RIBBON









3 x 46 W CLASSIC P ECO E-27

3 x 11 W E-27

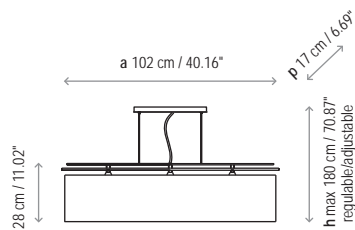

**CINTA / SUSPENSIÓN**  
**RIBBON / PENDANT LAMP**

4324405 T NÍQUEL CABLE TRANSPARENTE / *NICKEL TRANSPARENT WIRE*

4324405 R NÍQUEL CABLE ROJO / *NICKEL RED WIRE*

4324460 PIEL OSCURA CABLE TRANSPARENTE  
*DARK LEATHER TRANSPARENT WIRE*

4324461 PIEL CLARA CABLE TRANSPARENTE  
*CARAMEL LEATHER TRANSPARENT WIRE*

Pantalla rectangular plana 100 x 17 cm. Incluye difusor  
*Rectangular lampshade 39.37" x 6.69". Diffuser included*

P-521 CINTA TRANSLÚCIDA CREMA / *CREAM TRANSLUCENT RIBBON*

P-522 CINTA TRANSLÚCIDA BLANCA / *WHITE TRANSLUCENT RIBBON*

P-523 CINTA TRANSLÚCIDA ROJA / *RED TRANSLUCENT RIBBON*

P-524 COTONET / *COTTON*

Caja soporte 35 x 3,50 cm / *Surface back box 13.78" x 1.38"*



**ACABADOS / FINISHING**

NÍQUEL SATINADO  
*SATIN NICKEL*

PIEL OSCURA  
*DARK LEATHER*

PIEL CLARA  
*CARAMEL LEATHER*

COTONET  
*COTTON*

CINTA CREMA  
*CREAM RIBBON*

CINTA BLANCA  
*WHITE RIBBON*

CINTA ROJA  
*RED RIBBON*







# MARIETTA

DESIGN: JOANA BOVER 2015

## CINTA / SUSPENSIÓN RIBBON / PENDANT LAMP

### MARIETTA - 90

**BIG FORMAT**

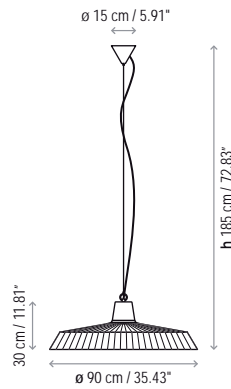

3310220262 ALUMINIO SATINADO / SATIN ALUMINIUM  
3310220289 COBRE SATINADO / SATIN COPPER

P-785 CINTA TRANSLÚCIDA BLANCA / WHITE TRANSLUCENT RIBBON  
P-786 CINTA TRANSLÚCIDA CREMA / CREAM TRANSLUCENT RIBBON  
P-787 CINTA TRANSLÚCIDA ROJA / RED TRANSLUCENT RIBBON

**BIG FORMAT**



28 W LED Led 84 x 0,33 W = 28 W Osram  
Lumens 3200 lm  
Valor cromático / CRI 85  
Grados Kelvin / Degrees Kelvin 2700°

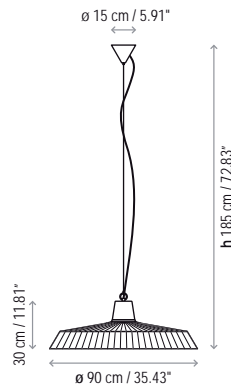

3310220862 LED ALUMINIO SATINADO / LED SATIN ALUMINIUM  
3310220889 LED COBRE SATINADO / LED SATIN COPPER

P-785 CINTA TRANSLÚCIDA BLANCA / WHITE TRANSLUCENT RIBBON  
P-786 CINTA TRANSLÚCIDA CREMA / CREAM TRANSLUCENT RIBBON  
P-787 CINTA TRANSLÚCIDA ROJA / RED TRANSLUCENT RIBBON



28 W LED Led 84 x 0,33 W = 28 W Osram  
Lumens 3200 lm  
Valor cromático / CRI 85  
Grados Kelvin / Degrees Kelvin 2700°

3310220962 LED DALI ALUMINIO SATINADO / LED DALI SATIN ALUMINIUM  
3310220989 LED DALI COBRE SATINADO / LED DALI SATIN COPPER

P-785 CINTA TRANSLÚCIDA BLANCA / WHITE TRANSLUCENT RIBBON  
P-786 CINTA TRANSLÚCIDA CREMA / CREAM TRANSLUCENT RIBBON  
P-787 CINTA TRANSLÚCIDA ROJA / RED TRANSLUCENT RIBBON

Difusor opal policarbonato / Opal polycarbonate diffuser  
Cable tensor ajustable / Adjustable tensor wire

\* Otras medidas consultar / Please consult for custom options

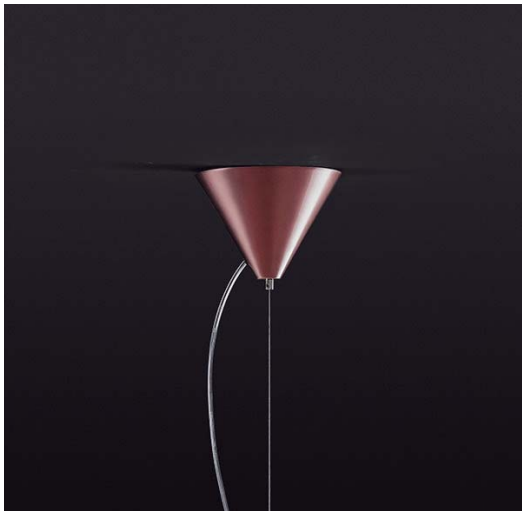

### ACABADOS / FINISHING

ALUMINIO SATINADO  
SATIN ALUMINIUM

COBRE SATINADO  
SATIN COPPER

CINTA CREMA  
CREAM RIBBON

CINTA BLANCA  
WHITE RIBBON

CINTA ROJA  
RED RIBBON





# MARIETTA

DESIGN: JOANA BOVER 2015

## CINTA / SUSPENSIÓN RIBBON / PENDANT LAMP

### MARIETTA - 120

**BIG FORMAT**

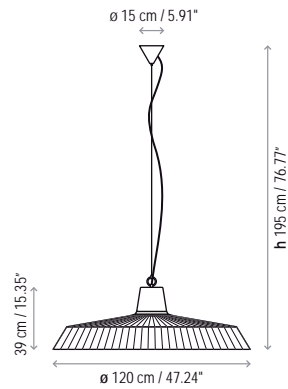

- 3310320262 ALUMINIO SATINADO / SATIN ALUMINIUM
- 3310320289 COBRE SATINADO / SATIN COPPER

- P-788 CINTA TRANSLÚCIDA BLANCA / WHITE TRANSLUCENT RIBBON
- P-789 CINTA TRANSLÚCIDA CREMA / CREAM TRANSLUCENT RIBBON
- P-800 CINTA TRANSLÚCIDA ROJA / RED TRANSLUCENT RIBBON

**BIG FORMAT**

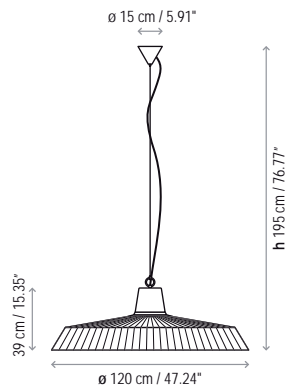
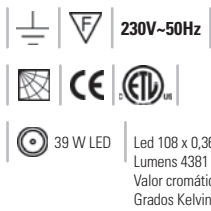

- 3310320862 LED ALUMINIO SATINADO / LED SATIN ALUMINIUM
- 3310320889 LED COBRE SATINADO / LED SATIN COPPER

- P-788 CINTA TRANSLÚCIDA BLANCA / WHITE TRANSLUCENT RIBBON
- P-789 CINTA TRANSLÚCIDA CREMA / CREAM TRANSLUCENT RIBBON
- P-800 CINTA TRANSLÚCIDA ROJA / RED TRANSLUCENT RIBBON

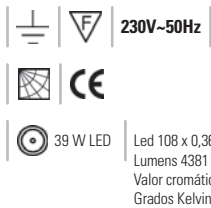

- 3310320962 LED DALI ALUMINIO SATINADO / LED DALI SATIN ALUMINIUM
- 3310320989 LED DALI COBRE SATINADO / LED DALI SATIN COPPER

- P-788 CINTA TRANSLÚCIDA BLANCA / WHITE TRANSLUCENT RIBBON
- P-789 CINTA TRANSLÚCIDA CREMA / CREAM TRANSLUCENT RIBBON
- P-800 CINTA TRANSLÚCIDA ROJA / RED TRANSLUCENT RIBBON

Difusor opal policarbonato / Opal polycarbonate diffuser  
Cable tensor ajustable / Adjustable tensor wire

\* Otras medidas consultar / Please consult for custom options



### ACABADOS / FINISHING

- ALUMINIO SATINADO / SATIN ALUMINIUM
- COBRE SATINADO / SATIN COPPER
- CINTA CREMA / CREAM RIBBON
- CINTA BLANCA / WHITE RIBBON
- CINTA ROJA / RED RIBBON







## MAXI - 01

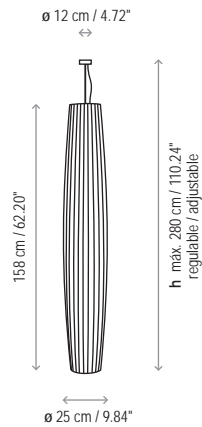

## CINTA / SUSPENSIÓN RIBBON / PENDANT LAMP

43195TOP INSTALACIÓN SUPERIOR / ELECTRICAL UPPER INSTALLATION  
4319505 INSTALACIÓN INFERIOR / ELECTRICAL BOTTOM INSTALLATION

Pantalla 158 X 25 cm / Lampshade 62.20" X 9.84"

P-507T TOP CINTA CREMA / TOP CREAM RIBBON  
P-508T TOP CINTA BLANCA / TOP WHITE RIBBON  
P-507I INST. INF. CINTA CREMA / BOTTOM INST. CREAM RIBBON  
P-508I INST. INF. CINTA BLANCA / BOTTOM INST. WHITE RIBBON

Altura regulable cable tensor con seguro / Adjustable tensor wire  
Florón níquel (sólo para instalación superior) / Nickel canopy (only for upper installation)  
Bombillas Eco Classic incluidas / Eco Classic bulbs included

Maxi 01 / Maxi 02 suspensión está disponible en dos versiones: con instalación superior y con instalación inferior.  
Maxi 01 / Maxi 02 pendant lamp comes in two versions: with upper installation and with bottom installation.

## MAXI - 02

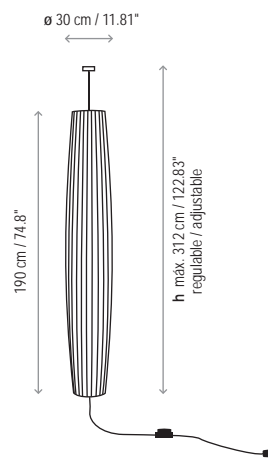

44195TOP INSTALACIÓN SUPERIOR / ELECTRICAL UPPER INSTALLATION  
4419505 INSTALACIÓN INFERIOR / ELECTRICAL BOTTOM INSTALLATION

Pantalla 190 X 30 cm / Lampshade 74.8" X 11.81"

P-506T TOP CINTA CREMA / TOP CREAM RIBBON  
P-509T TOP CINTA BLANCA / TOP WHITE RIBBON  
P-506I INST. INF. CINTA CREMA / BOTTOM INST. CREAM RIBBON  
P-509I INST. INF. CINTA BLANCA / BOTTOM INST. WHITE RIBBON

Altura regulable cable tensor con seguro / Adjustable tensor wire  
Florón níquel (sólo para instalación superior) / Nickel canopy (only for upper installation)  
Bombillas Eco Classic incluidas / Eco Classic bulbs included

Maxi 01 / Maxi 02 suspensión está disponible en dos versiones: con instalación superior y con instalación inferior.  
Maxi 01 / Maxi 02 pendant lamp comes in two versions: with upper installation and with bottom installation.

## MAXI - 03 / DIMABLE

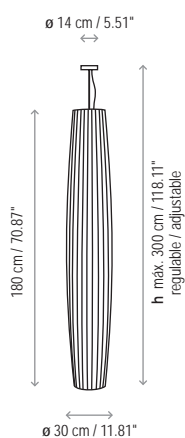
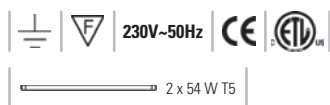

4303195TOP INSTALACIÓN SUPERIOR / ELECTRICAL UPPER INSTALLATION  
REGULABLE SISTEMA DALI / DALI DIMMING SYSTEM

Pantalla 180 X 30 cm / Lampshade 70.87" X 11.81"

P-754T TOP CINTA CREMA / TOP CREAM RIBBON  
P-755T TOP CINTA BLANCA / TOP WHITE RIBBON

Altura regulable cable tensor con seguro / Adjustable tensor wire  
Florón níquel / Nickel canopy  
Inclusión de tubos fluorescentes ya instalados en el interior de la luminaria / Supply fluorescent tubes already installed inside the luminaire.

## FAMILIA / FAMILY

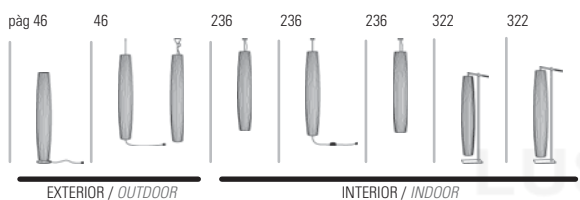

## ACABADOS / FINISHING

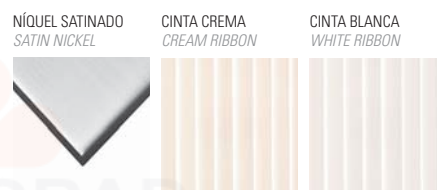









Custom product

**MEI - 38**

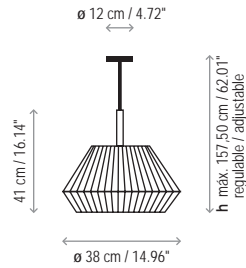

**CINTA / SUSPENSIÓN**  
**RIBBON / PENDANT LAMP**

- 4219903 HIERRO MARRÓN / BROWN IRON
- 4219904 HIERRO NEGRO / BLACK IRON
- 4219905 NÍQUEL SATINADO / SATIN NICKEL

Pantalla 32 x 19 x 20 cm / Lampshade 12.60" x 7.48" x 7.87"  
Incluye difusor / Diffuser included  
Conexión transparente / Transparent connection

- P-495C CINTA TRANSLÚCIDA ROJA / RED TRANSLUCENT RIBBON
- P-504C CINTA TRANSLÚCIDA CREMA / CREAM TRANSLUCENT RIBBON
- P-505C CINTA TRANSLÚCIDA BLANCA / WHITE TRANSLUCENT RIBBON

**MEI - 60**

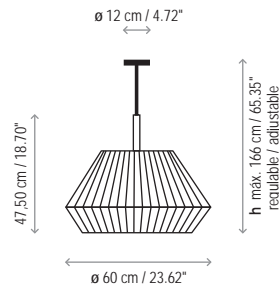

- 4119903 HIERRO MARRÓN / BROWN IRON
- 4119904 HIERRO NEGRO / BLACK IRON
- 4119905 NÍQUEL SATINADO / SATIN NICKEL

Pantalla 50 x 31 x 30 cm / Lampshade 19.69" x 12.20" x 11.81"  
Incluye difusor / Diffuser included  
Conexión transparente / Transparent connection

- P-496C CINTA TRANSLÚCIDA NEGRA / BLACK TRANSLUCENT RIBBON
- P-501C CINTA TRANSLÚCIDA ROJA / RED TRANSLUCENT RIBBON
- P-502C CINTA TRANSLÚCIDA CREMA / CREAM TRANSLUCENT RIBBON
- P-503C CINTA TRANSLÚCIDA BLANCA / WHITE TRANSLUCENT RIBBON

**MEI - 90** **BIG FORMAT**

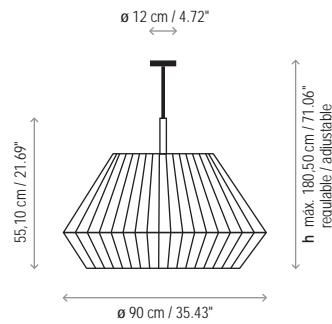

- 4419903 HIERRO MARRÓN / BROWN IRON
- 4419904 HIERRO NEGRO / BLACK IRON
- 4419905 NÍQUEL SATINADO / SATIN NICKEL

Pantalla 80 x 41,50 x 35 cm / Lampshade 31.50" x 16.34" x 13.78"  
Incluye difusor / Diffuser included  
Conexión transparente / Transparent connection

- P-490C CINTA TRANSLÚCIDA BLANCA / WHITE TRANSLUCENT RIBBON
- P-491C CINTA TRANSLÚCIDA CREMA / CREAM TRANSLUCENT RIBBON
- P-492C CINTA TRANSLÚCIDA ROJA / RED TRANSLUCENT RIBBON
- P-493C CINTA TRANSLÚCIDA NEGRA / BLACK TRANSLUCENT RIBBON

**ACABADOS / FINISHING**



**FAMILIA / FAMILY**

pàg 240 240 240 242 242







**MEI - 125** **BIG FORMAT**

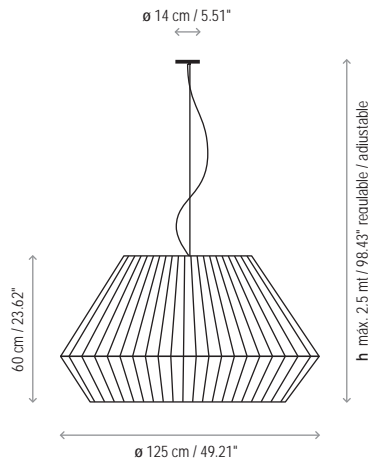

**CINTA / SUSPENSIÓN**  
**RIBBON / PENDANT LAMP**

- 4719903 HIERRO MARRÓN / BROWN IRON
- 4719904 HIERRO NEGRO / BLACK IRON
- 4719905 NÍQUEL SATINADO / SATIN NICKEL

Pantalla 125 x 60 x 48 cm / Lampshade 49.21" x 23.62" x 18.90"  
Incluye difusor / Diffuser included  
Conexión transparente / Transparent connection

- P-720C CINTA TRANSLÚCIDA BLANCA / WHITE TRANSLUCENT RIBBON
- P-721C CINTA TRANSLÚCIDA CREMA / CREAM TRANSLUCENT RIBBON
- P-722C CINTA TRANSLÚCIDA ROJA / RED TRANSLUCENT RIBBON
- P-723C CINTA TRANSLÚCIDA NEGRA / BLACK TRANSLUCENT RIBBON

**MEI - 150** **BIG FORMAT**

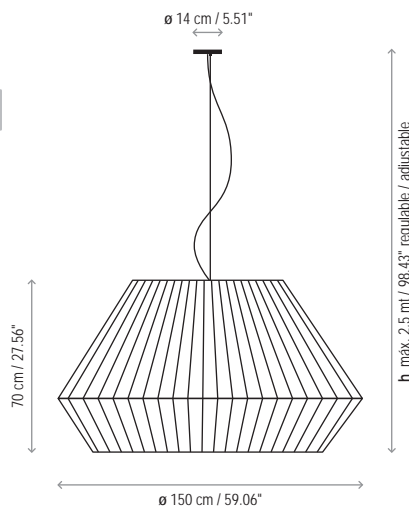

- 4619903 HIERRO MARRÓN / BROWN IRON
- 4619904 HIERRO NEGRO / BLACK IRON
- 4619905 NÍQUEL SATINADO / SATIN NICKEL

Pantalla 150 x 70 x 59 cm / Lampshade 59.06" x 27.56" x 23.23"  
Incluye difusor / Diffuser included  
Conexión transparente / Transparent connection  
Portalámparas cerámicos / Porcelain lampholders

- P-590C CINTA TRANSLÚCIDA BLANCA / WHITE TRANSLUCENT RIBBON
- P-591C CINTA TRANSLÚCIDA CREMA / CREAM TRANSLUCENT RIBBON
- P-592C CINTA TRANSLÚCIDA ROJA / RED TRANSLUCENT RIBBON
- P-593C CINTA TRANSLÚCIDA NEGRA / BLACK TRANSLUCENT RIBBON

**ACABADOS / FINISHING**



**FAMILIA / FAMILY**

pàg 240 240 240 242 242









**CINTA / SUSPENSIÓN**  
**RIBBON / PENDANT LAMP**

**MEI - 100**

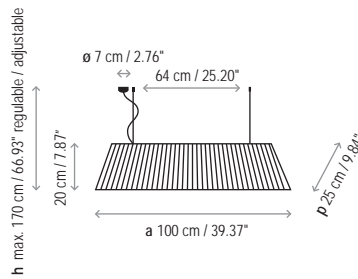

- 4319903 HIERRO MARRÓN / BROWN IRON
- 4319904 HIERRO NEGRO / BLACK IRON
- 4319905 NÍQUEL SATINADO / SATIN NICKEL

Pantalla rectangular 100 x 25 cm / Rectangular lampshade 39.37" x 9.84"  
Incluye difusor / Diffuser included

- P-497C CINTA TRANSLÚCIDA CREMA / CREAM TRANSLUCENT RIBBON
- P-498C COTONET / COTTON
- P-499C LINO / LINEN
- P-584C CINTA TRANSLÚCIDA BLANCA / WHITE TRANSLUCENT RIBBON
- P-585C CINTA TRANSLÚCIDA ROJA / RED TRANSLUCENT RIBBON
- P-586C CINTA TRANSLÚCIDA NEGRA / BLACK TRANSLUCENT RIBBON

Altura regulable cable tensor con seguro / Adjustable tensor wire

**MEI - 120**

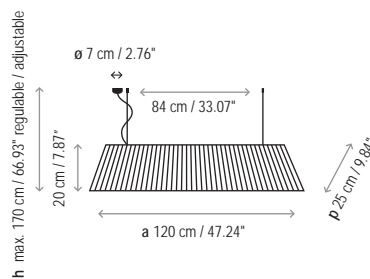

- 4519903 HIERRO MARRÓN / BROWN IRON
- 4519904 HIERRO NEGRO / BLACK IRON
- 4519905 NÍQUEL SATINADO / SATIN NICKEL

Pantalla rectangular 120 x 25 cm / Rectangular lampshade 47.24" x 9.84"  
Incluye difusor / Diffuser included

- P-510C CINTA TRANSLÚCIDA CREMA / CREAM TRANSLUCENT RIBBON
- P-511C COTONET / COTTON
- P-512C LINO / LINEN
- P-514C CINTA TRANSLÚCIDA BLANCA / WHITE TRANSLUCENT RIBBON
- P-522C CINTA TRANSLÚCIDA ROJA / RED TRANSLUCENT RIBBON
- P-523C CINTA TRANSLÚCIDA NEGRA / BLACK TRANSLUCENT RIBBON

Altura regulable cable tensor con seguro / Adjustable tensor wire

**MEI - 180** **BIG FORMAT**

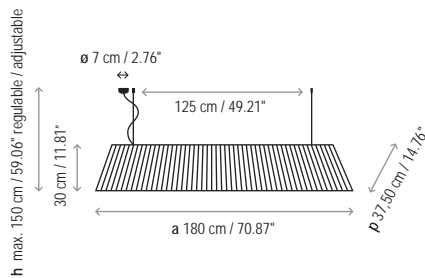

- 430319903 HIERRO MARRÓN / BROWN IRON
- 430319904 HIERRO NEGRO / BLACK IRON
- 430319905 NÍQUEL SATINADO / SATIN NICKEL

Pantalla rectangular 180 x 37,50 cm / Rectangular lampshade 70.87" x 14.76"  
Incluye difusor / Diffuser included

- P-756C CINTA TRANSLÚCIDA CREMA / CREAM TRANSLUCENT RIBBON
- P-757C COTONET / COTTON
- P-758C LINO / LINEN
- P-759C CINTA TRANSLÚCIDA BLANCA / WHITE TRANSLUCENT RIBBON
- P-760C CINTA TRANSLÚCIDA ROJA / RED TRANSLUCENT RIBBON
- P-761C CINTA TRANSLÚCIDA NEGRA / BLACK TRANSLUCENT RIBBON

Altura regulable cable tensor con seguro / Adjustable tensor wire

**ACABADOS / FINISHING**

- NÍQUEL SATINADO  
SATIN NICKEL
- HIERRO MARRÓN  
BROWN IRON
- HIERRO NEGRO  
BLACK IRON
- LINO  
LINEN
- COTONET  
COTTON
- CINTA CREMA  
CREAM RIBBON
- CINTA BLANCA  
WHITE RIBBON
- CINTA ROJA  
RED RIBBON
- CINTA NEGRA  
BLACK RIBBON











# MEI OVAL

DESIGN: JOANA BOVER 2006



3 x 46 W CLASSIC P ECO E-27

3 x 11 W E-27  
Duluxstar Mini Twist

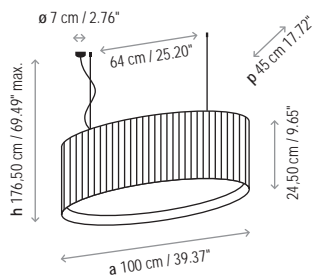

## CINTA / SUSPENSIÓN RIBBON / PENDANT LAMP

- 4319903 HIERRO MARRÓN / BROWN IRON
- 4319904 HIERRO NEGRO / BLACK IRON
- 4319905 NÍQUEL SATINADO / SATIN NICKEL

Pantalla oval 100 x 24,50 x 44 cm / Oval lampshade 39.37" x 9.65" x 17.32"

- P-545C CINTA TRANSLÚCIDA BLANCA / WHITE TRANSLUCENT RIBBON
- P-546C CINTA TRANSLÚCIDA CREMA / CREAM TRANSLUCENT RIBBON
- P-547C CINTA TRANSLÚCIDA NEGRA / BLACK TRANSLUCENT RIBBON
- P-548C COTONET BLANCO / WHITE COTTON

Altura regulable cable tensor con seguro / Adjustable tensor wire



## ACABADOS / FINISHING

NÍQUEL SATINADO  
SATIN NICKEL

HIERRO MARRÓN  
BROWN IRON

HIERRO NEGRO  
BLACK IRON



CINTA CREMA  
CREAM RIBBON

CINTA BLANCA  
WHITE RIBBON

CINTA NEGRA  
BLACK RIBBON

COTONET BLANCO  
WHITE COTTON



## FAMILIA / FAMILY

pàg 200 200 248 310 310 310 324





STROUGR



# MOS

DESIGN: JOANA BOVER 2008

## MOS - 01

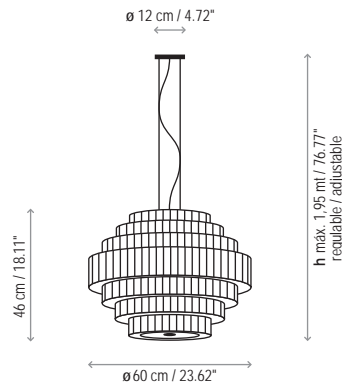

## CINTA / SUSPENSIÓN RIBBON / PENDANT LAMP

- 224P617 CINTA TRANSLÚCIDA BLANCA / WHITE TRANSLUCENT RIBBON
- 224P618 CINTA TRANSLÚCIDA CREMA / CREAM TRANSLUCENT RIBBON
- 224P619 CINTA TRANSLÚCIDA ROJA / RED TRANSLUCENT RIBBON

Incluye difusor inferior cristal opal blanco / Diffuser white opal glass included  
 Instalación níquel satinado / Satin nickel  
 Conexión transparente / Transparent connection  
 Altura regulable / Adjustable tensor wire  
 Cable tensor + seguro / Safety tensor wire

## MOS - 02

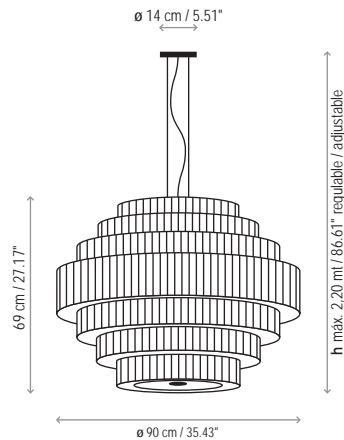
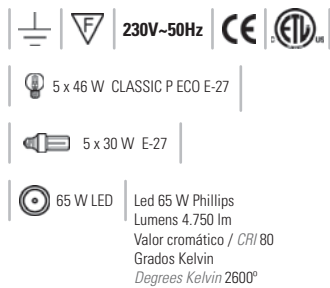

- 224P622 CINTA TRANSLÚCIDA BLANCA / WHITE TRANSLUCENT RIBBON
- 224P623 CINTA TRANSLÚCIDA CREMA / CREAM TRANSLUCENT RIBBON
- 224P624 CINTA TRANSLÚCIDA ROJA / RED TRANSLUCENT RIBBON

- D224P622L REGULABLE SISTEMA DALI CINTA TRANSL. BLANCA  
DALI DIMMING SYSTEM WHITE TRANSL. RIBBON
- D224P623L REGULABLE SISTEMA DALI CINTA TRANSL. CREMA  
DALI DIMMING SYSTEM CREAM TRANSL. RIBBON
- D224P624L REGULABLE SISTEMA DALI CINTA TRANSL. ROJA  
DALI DIMMING SYSTEM RED TRANSL. RIBBON

Incluye difusor inferior cristal opal blanco / Diffuser white opal glass included  
 Instalación níquel satinado / Satin nickel  
 Conexión transparente / Transparent connection  
 Altura regulable / Adjustable tensor wire  
 Cable tensor + seguro / Safety tensor wire

## MOS - 03 **BIG FORMAT**

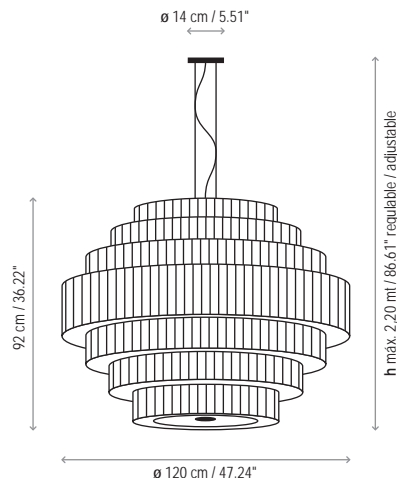
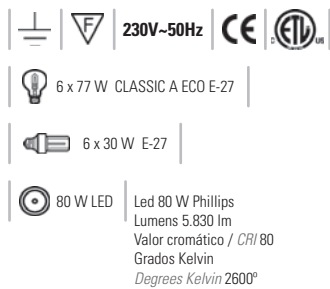

- 224P621 CINTA TRANSLÚCIDA BLANCA / WHITE TRANSLUCENT RIBBON
- 224P625 CINTA TRANSLÚCIDA CREMA / CREAM TRANSLUCENT RIBBON
- 224P626 CINTA TRANSLÚCIDA ROJA / RED TRANSLUCENT RIBBON

- D224P621L REGULABLE SISTEMA DALI CINTA TRANSL. BLANCA  
DALI DIMMING SYSTEM WHITE TRANSL. RIBBON
- D224P625L REGULABLE SISTEMA DALI CINTA TRANSL. CREMA  
DALI DIMMING SYSTEM CREAM TRANSL. RIBBON
- D224P626L REGULABLE SISTEMA DALI CINTA TRANSL. ROJA  
DALI DIMMING SYSTEM RED TRANSL. RIBBON

- CINTA CREMA  
CREAM RIBBON
- CINTA BLANCA  
WHITE RIBBON
- CINTA ROJA  
RED RIBBON







Poliform / Italy



Hostal Empúries / L'Escala





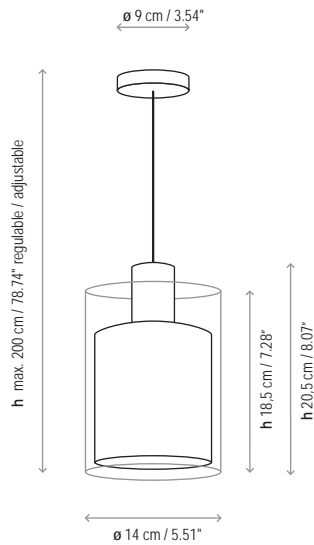

4131306 CROMO / CHROME

Pantalla 12 x 13 cm / Lampshade 4.72"x 5.12"

- P-734C CINTA TRANSLÚCIDA BLANCA / WHITE TRANSLUCENT RIBBON
- P-735C CINTA TRANSLÚCIDA CREMA / CREAM TRANSLUCENT RIBBON
- P-736C CINTA TRANSLÚCIDA ROJA / RED TRANSLUCENT RIBBON
- P-737C COTONET BLANCO / WHITE COTTON
- P-738C COTONET NEGRO / BLACK COTTON
- P-739C BLANCO INTERIOR NARANJA / WHITE-ORANGE INNER
- P-740C NEGRO INTERIOR NARANJA / BLACK-ORANGE INNER

Bombilla incluida / Bulb included

Material: Vidrio borosilicato / Borosilicate glass

Conexión transparente / Transparent connection

Altura regulable / Adjustable wire



**FAMILIA / FAMILY**

pàg 254 278



**ACABADOS / FINISHING**

CROMO BRILLANTE  
BRILLIANT CHROME

CINTA CREMA  
CREAM RIBBON

CINTA BLANCA  
WHITE RIBBON

CINTA ROJA  
RED RIBBON

COTONET BLANCO  
WHITE COTTON

COTONET NEGRO  
COTTON BLACK

COTONET BLANCO  
INTERIOR NARANJA  
COTTON WHITE  
ORANGE INSIDE

COTONET NEGRO  
INTERIOR NARANJA  
COTTON BLACK  
ORANGE INSIDE







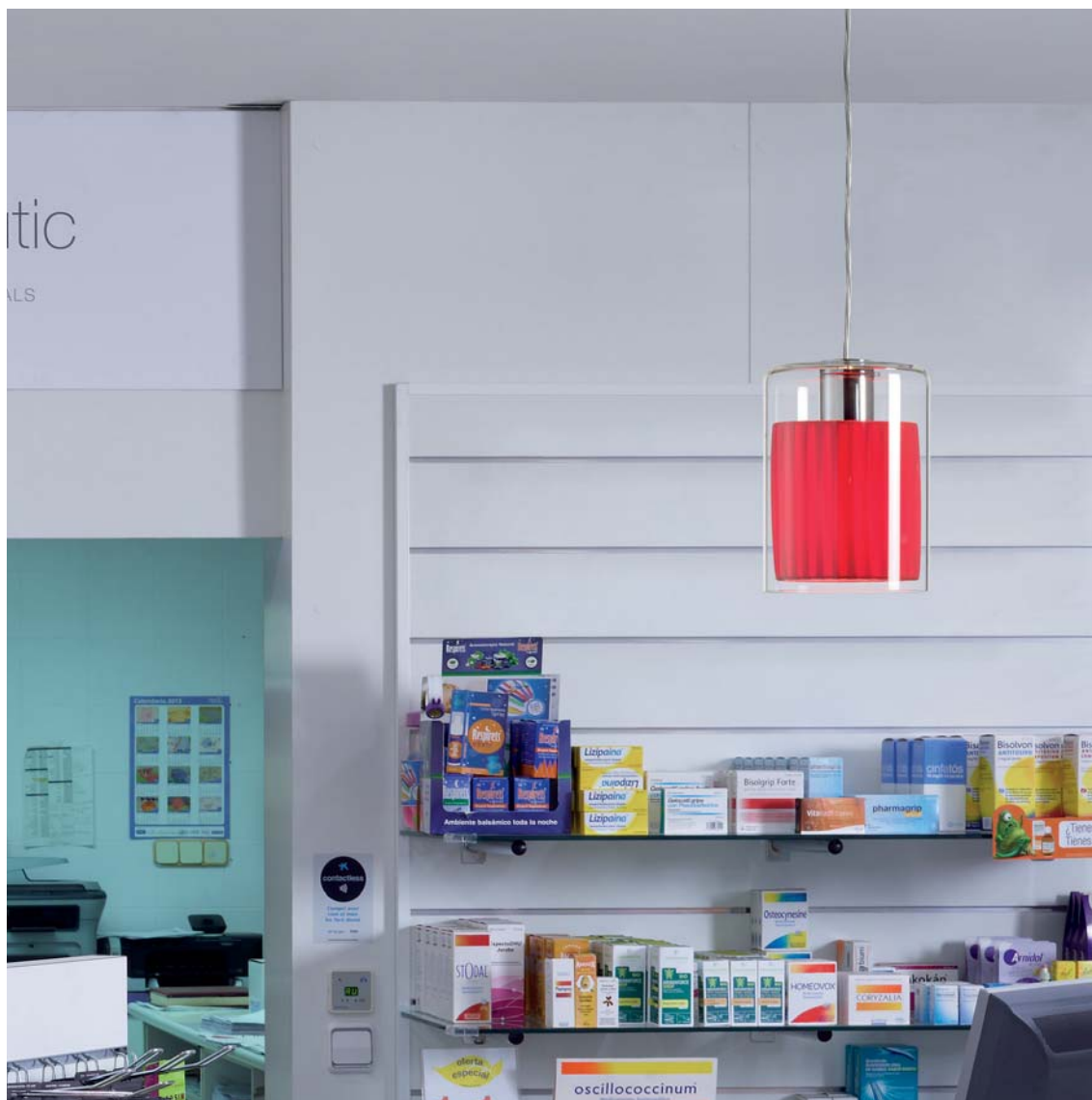







**CINTA / SUSPENSIÓN**  
**RIBBON / PENDANT LAMP**

**SIAM - 4 L** **BIG FORMAT**

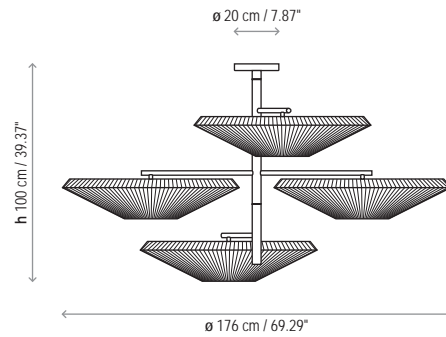

4432005 NÍQUEL SATINADO / SATIN NICKEL  
4432001 BLANCO 9010 CRUDO / WHITE 9010

Pantalla 80 x 18 cm ( x 4 UNIDADES / Lampshade: 31.50" x 7.09" ( x 4 UNITS)

P-686C CINTA TRANSLÚCIDA BLANCA / WHITE TRANSLUCENT RIBBON  
P-687C CINTA TRANSLÚCIDA CREMA / CREAM TRANSLUCENT RIBBON  
P-688C CINTA TRANSLÚCIDA ROJA / RED TRANSLUCENT RIBBON

**SIAM - 6 L** **BIG FORMAT**

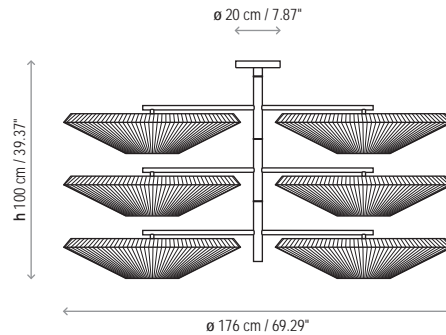

4632005 NÍQUEL SATINADO / SATIN NICKEL  
4632001 BLANCO 9010 CRUDO / WHITE 9010

Pantalla 80 x 18 cm ( x 6 UNIDADES / Lampshade: 31.50" x 7.09" ( x 6 UNITS)

P-686C CINTA TRANSLÚCIDA BLANCA / WHITE TRANSLUCENT RIBBON  
P-687C CINTA TRANSLÚCIDA CREMA / CREAM TRANSLUCENT RIBBON  
P-688C CINTA TRANSLÚCIDA ROJA / RED TRANSLUCENT RIBBON

**FAMILIA / FAMILY**

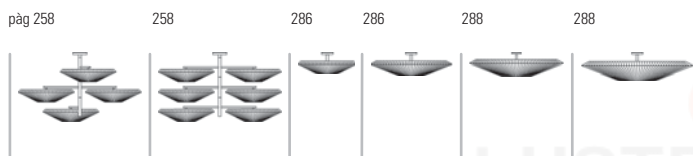

**ACABADOS / FINISHING**

BLANCO 9010 WHITE 9010 NÍQUEL SATINADO SATIN NICKEL CINTA CREMA CREAM RIBBON CINTA BLANCA WHITE RIBBON CINTA ROJA RED RIBBON















# SILANTRA

DESIGN: CHRISTOPHE MATHIEU 2004

## SILANTRA - 07

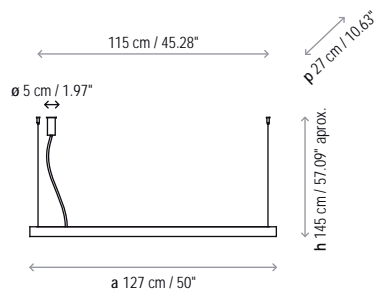
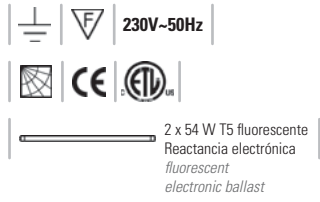

## CINTA / SUSPENSIÓN RIBBON / PENDANT LAMP

- 7245537 CINTA TRANSLÚCIDA CREMA  
CREAM TRANSLUCENT RIBBON
- 7245538 CINTA TRANSLÚCIDA BLANCA  
WHITE TRANSLUCENT RIBBON
- D7245537 REGULABLE SISTEMA DALI / CINTA TRANSLÚCIDA CREMA  
DALI DIMMING SYSTEM / CREAM TRANSLUCENT RIBBON
- D7245538 REGULABLE SISTEMA DALI / CINTA TRANSLÚCIDA BLANCA  
DALI DIMMING SYSTEM / WHITE TRANSLUCENT RIBBON

Aluminio pulido / Polished aluminium  
Pantalla 127 x 27 cm / Lampshade 50" x 10.63"

## FAMILIA / FAMILY

pàg 204 204 204 206 206 206 262

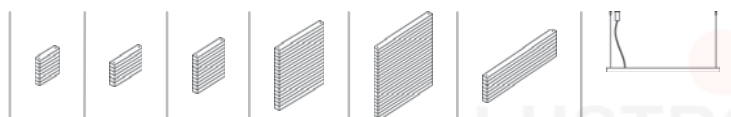

## ACABADOS / FINISHING

NÍQUEL SATINADO SATIN NICKEL  
CINTA CREMA CREAM RIBBON  
CINTA BLANCA WHITE RIBBON











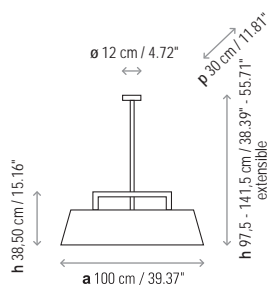
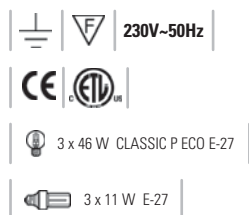

**CINTA / SUSPENSIÓN**  
**RIBBON / PENDANT LAMP**

- 4323905 NÍQUEL SATINADO / SATIN NICKEL
- 4323960 NÍQUEL PIEL OSCURA / NICKEL DARK LEATHER
- 4323961 NÍQUEL PIEL CLARA / NICKEL CARAMEL LEATHER

Pantalla rectangular 100 x 30 x 23 cm  
Rectangular lampshade 39.37" x 11.81" x 9.06"  
Con difusor inferior / With lower diffuser

- P-482C LINO / LINEN
- P-483C COTONET / COTTON
- P-683 CINTA TRANSLÚCIDA BLANCA / WHITE TRANSLUCENT RIBBON
- P-684 CINTA TRANSLÚCIDA CREMA / CREAM TRANSLUCENT RIBBON

**FAMILIA / FAMILY**

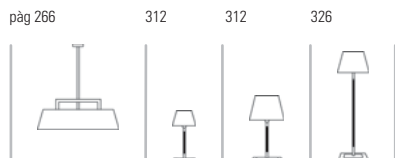

**ACABADOS / FINISHING**

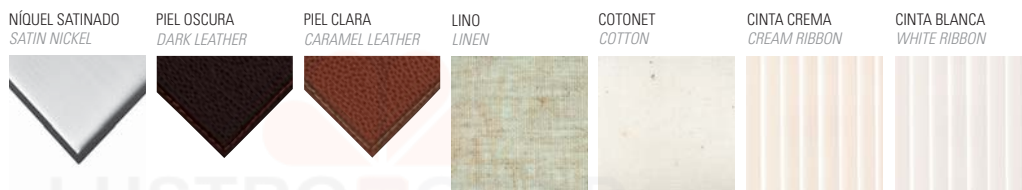





## TEKNO - LP100

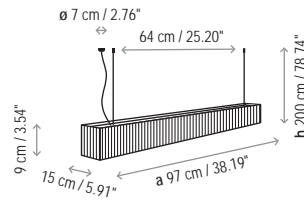
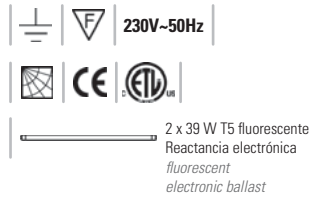

## CINTA / SUSPENSIÓN RIBBON / PENDANT LAMP

- 4218801 CINTA TRANSLÚCIDA BLANCA / WHITE TRANSLUCENT RIBBON
- 4218802 CINTA TRANSLÚCIDA CREMA / CREAM TRANSLUCENT RIBBON
- 4218803 COTONET BLANCO / WHITE COTTON
- 4218804 CINTA TRANSLÚCIDA ROJA / RED TRANSLUCENT RIBBON
- D4218801 REGULABLE SISTEMA DALI CINTA BLANCA  
DALI DIMMING WHITE TRANSLUCENT RIBBON
- D4218802 REGULABLE SISTEMA DALI CINTA CREMA  
DALI DIMMING CREAM TRANSLUCENT RIBBON
- D4218803 REGULABLE SISTEMA DALI COTONET BLANCO  
DALI DIMMING WHITE COTTON
- D4218804 REGULABLE SISTEMA DALI CINTA ROJA  
DALI DIMMING RED TRANSLUCENT RIBBON

Debido a la naturaleza de la cinta translúcida, las pantallas de cinta clara reflejan ligeramente los radios del armazón de la pantalla.  
*Due to translucent ribbon's nature, light colour shade may reflect the inner structure.*

## TEKNO - LP120

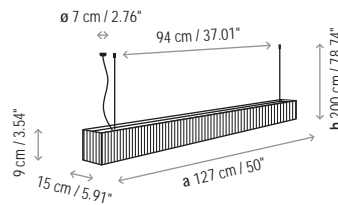
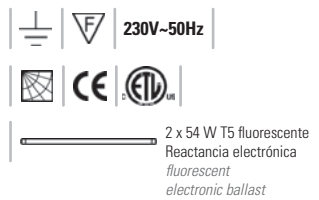

- 4318801 CINTA TRANSLÚCIDA BLANCA / WHITE TRANSLUCENT RIBBON
- 4318802 CINTA TRANSLÚCIDA CREMA / CREAM TRANSLUCENT RIBBON
- 4318803 COTONET BLANCO / WHITE COTTON
- 4318804 CINTA TRANSLÚCIDA ROJA / RED TRANSLUCENT RIBBON
- D4318801 REGULABLE SISTEMA DALI CINTA BLANCA  
DALI DIMMING WHITE TRANSLUCENT RIBBON
- D4318802 REGULABLE SISTEMA DALI CINTA CREMA  
DALI DIMMING CREAM TRANSLUCENT RIBBON
- D4318803 REGULABLE SISTEMA DALI COTONET BLANCO  
DALI DIMMING WHITE COTTON
- D4318804 REGULABLE SISTEMA DALI CINTA ROJA  
DALI DIMMING RED TRANSLUCENT RIBBON

Debido a la naturaleza de la cinta translúcida, las pantallas de cinta clara reflejan ligeramente los radios del armazón de la pantalla.  
*Due to translucent ribbon's nature, light colour shade may reflect the inner structure.*



## ACABADOS / FINISHING

- CINTA CREMA  
CREAM RIBBON
- CINTA BLANCA  
WHITE RIBBON
- CINTA ROJA  
RED RIBBON
- COTONET BLANCO  
WHITE COTTON



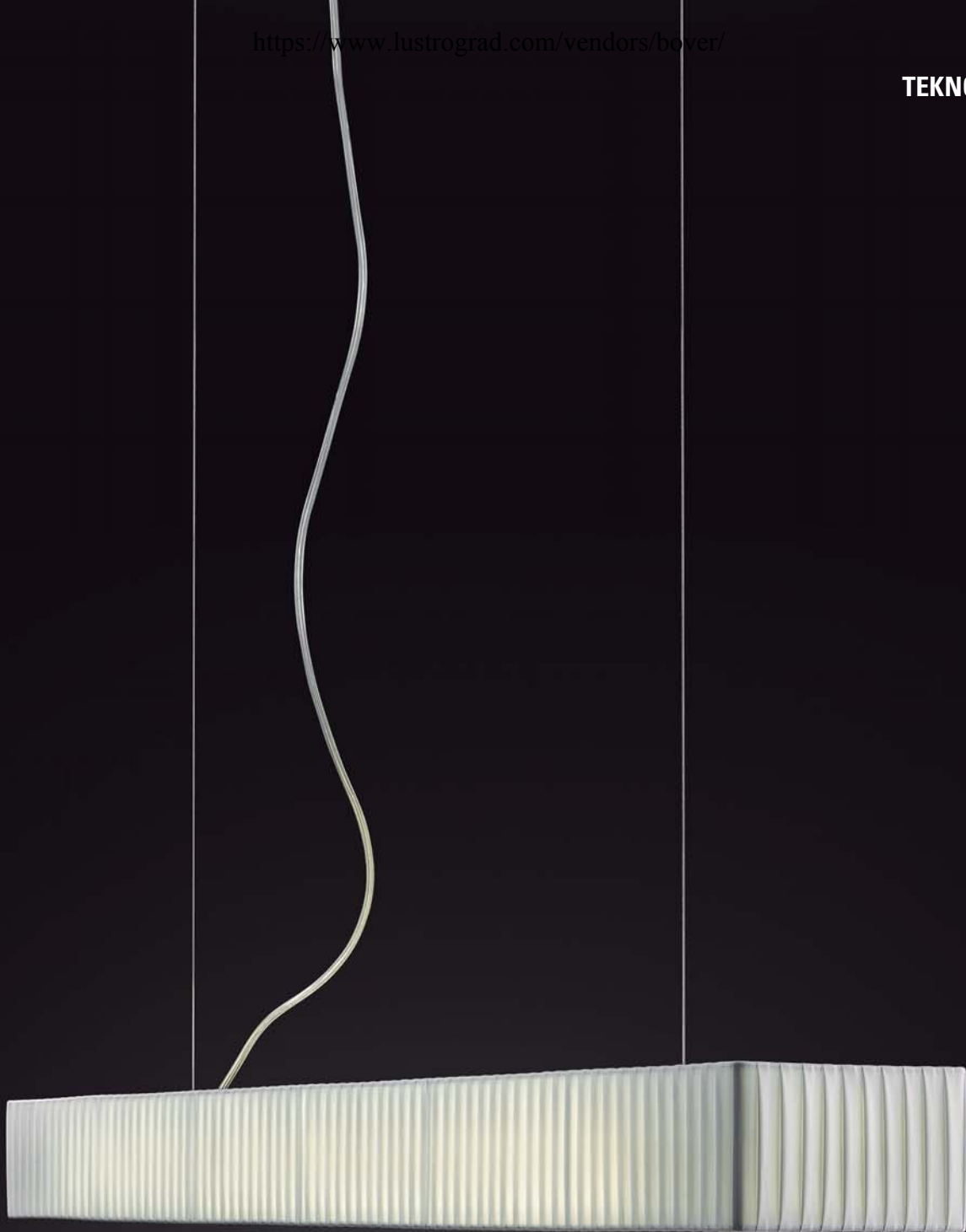

## TEKNO - CP

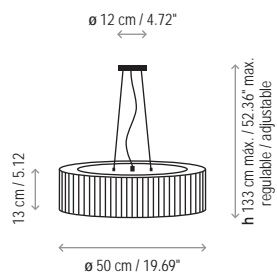

## CINTA / SUSPENSIÓN RIBBON / PENDANT LAMP

- 4118856 NÍQUEL COTONET BLANCO / NICKEL WHITE COTTON
- 4118857 NÍQUEL CINTA TRANSLÚCIDA BLANCA / NICKEL WHITE TRANSLUCENT RIBBON
- 4118858 NÍQUEL CINTA TRANSLÚCIDA CREMA / NICKEL CREAM TRANSLUCENT RIBBON
- 4118859 NÍQUEL CINTA TRANSLÚCIDA ROJA / NICKEL RED TRANSLUCENT RIBBON

Altura regulable cable tensor con seguro / Adjustable tensor wire  
Conexión cable rojo / Red wire connection  
Difusor / Diffuser

## ACABADOS / FINISHING

- NÍQUEL SATINADO / SATIN NICKEL
- COTONET BLANCO / WHITE COTTON
- CINTA CREMA / CREAM RIBBON
- CINTA BLANCA / WHITE RIBBON
- CINTA ROJA / RED RIBBON







# 272 URBAN

DESIGN: JOANA BOVER 2011

## URBAN - 37

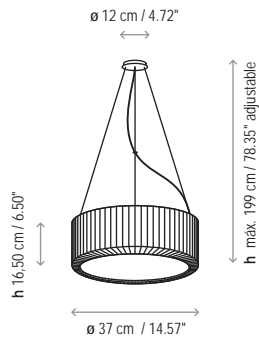

## CINTA / SUSPENSIÓN RIBBON / PENDANT LAMP

- 410132506B CROMO-CINTA TRANSLÚCIDA BLANCA  
CHROME-WHITE TRANSLUCENT RIBBON
- 410132506C CROMO-CINTA TRANSLÚCIDA CREMA  
CHROME-CREAM TRANSLUCENT RIBBON
- 410132506R CROMO-CINTA TRANSLÚCIDA ROJA  
CHROME-RED TRANSLUCENT RIBBON

## URBAN - 60

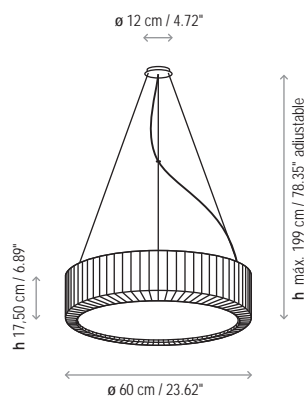
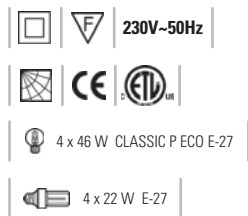

- 410232506B CROMO-CINTA TRANSLÚCIDA BLANCA  
CHROME-WHITE TRANSLUCENT RIBBON
- 410232506C CROMO-CINTA TRANSLÚCIDA CREMA  
CHROME-CREAM TRANSLUCENT RIBBON
- 410232506R CROMO-CINTA TRANSLÚCIDA ROJA  
CHROME-RED TRANSLUCENT RIBBON

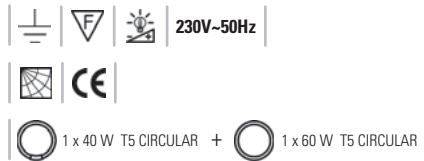

- D410232506B REGULABLE SISTEMA DALI/CROMO-CINTA TRANSL. BLANCA  
DALI DIMMING SYSTEM /CHROME-WHITE TRANSL. RIBBON
- D410232506C REGULABLE SISTEMA DALI/CROMO-CINTA TRANSL. CREMA  
DALI DIMMING SYSTEM /CHROME-CREAM TRANSL. RIBBON
- D410232506R REGULABLE SISTEMA DALI/CROMO-CINTA TRANSLÚCIDA ROJA  
DALI DIMMING SYSTEM /CHROME-RED TRANSLUCENT RIBBON

## URBAN - 90 **BIG FORMAT**

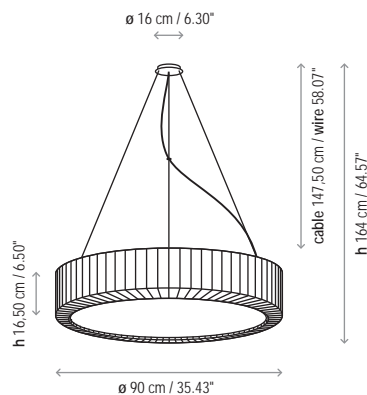

- 410432506B CROMO-CINTA TRANSLÚCIDA BLANCA  
CHROME-WHITE TRANSLUCENT RIBBON
- 410432506C CROMO-CINTA TRANSLÚCIDA CREMA  
CHROME-CREAM TRANSLUCENT RIBBON
- 410432506R CROMO-CINTA TRANSLÚCIDA ROJA  
CHROME-RED TRANSLUCENT RIBBON

## FAMILIA / FAMILY

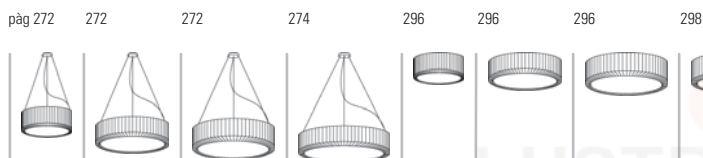

## ACABADOS / FINISHING

- CROMO BRILLANTE  
BRILLIANT CHROME
- CINTA CREMA  
CREAM RIBBON
- CINTA BLANCA  
WHITE RIBBON
- CINTA ROJA  
RED RIBBON







# 274 URBAN

DESIGN: JOANA BOVER 2011

## URBAN - 120 **BIG FORMAT**

230V-50Hz

CE ETL

6 x 36 W 2G11

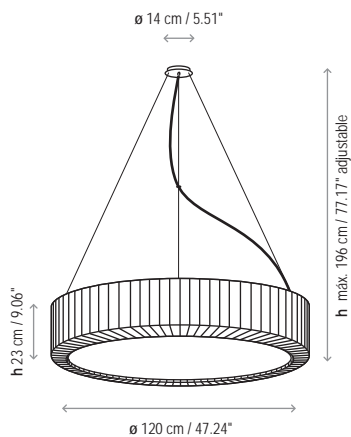

### CINTA / SUSPENSIÓN RIBBON / PENDANT LAMP

- 410332506B CROMO-CINTA TRANSLÚCIDA BLANCA  
*CHROME-WHITE TRANSLUCENT RIBBON*
- 410332506C CROMO-CINTA TRANSLÚCIDA CREMA  
*CHROME-CREAM TRANSLUCENT RIBBON*
- 410332506R CROMO-CINTA TRANSLÚCIDA ROJA  
*CHROME-RED TRANSLUCENT RIBBON*
- D410332506B REGULABLE SISTEMA DALI/CROMO-CINTA TRANSL. BLANCA  
*DALI DIMMING SYSTEM /CHROME-WHITE TRANSL. RIBBON*
- D410332506C REGULABLE SISTEMA DALI/CROMO-CINTA TRANSL. CREMA  
*DALI DIMMING SYSTEM /CHROME-CREAM TRANSL. RIBBON*
- D410332506R REGULABLE SISTEMA DALI/CROMO-CINTA TRANSLÚCIDA ROJA  
*DALI DIMMING SYSTEM /CHROME-RED TRANSLUCENT RIBBON*



### FAMILIA / FAMILY

pàg 272 272 272 274 296 296 296 298



### ACABADOS / FINISHING

CROMO BRILLANTE  
*BRILLIANT CHROME*    CINTA CREMA  
*CREAM RIBBON*    CINTA BLANCA  
*WHITE RIBBON*    CINTA ROJA  
*RED RIBBON*





# KUADRAT

DESIGN: JOANA BOVER 2008

## KUADRAT - F

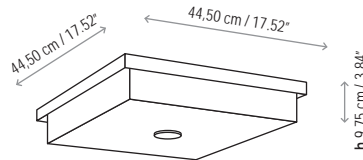

### CINTA / PLAFÓN RIBBON / CEILING

- 5015105F NÍQUEL SATINADO / SATIN NICKEL
- 5015106F CROMO BRILLANTE / BRILLIANT CHROME
- 5015108F GRIS GRAFITO / GREY GRAPHITE

Interior pantalla cotonet en poliéster / Inner cotton shade in polyester

- P-628 COTONET BLANCO / WHITE COTTON
- P-629 CINTA TRANSLÚCIDA BLANCA / WHITE TRANSLUCENT RIBBON
- P-630 CINTA TRANSLÚCIDA CREMA / CREAM TRANSLUCENT RIBBON

Difusor: cristal óptico mate / Diffuser: optical matte glass diffuser

## KUADRAT - I

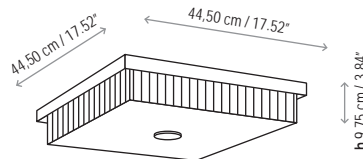

- 5015105I NÍQUEL SATINADO / SATIN NICKEL
- 5015106I CROMO BRILLANTE / BRILLIANT CHROME
- 5015108I GRIS GRAFITO / GREY GRAPHITE

Interior pantalla cotonet en poliéster / Inner cotton shade in polyester

- P-628 COTONET BLANCO / WHITE COTTON
- P-629 CINTA TRANSLÚCIDA BLANCA / WHITE TRANSLUCENT RIBBON
- P-630 CINTA TRANSLÚCIDA CREMA / CREAM TRANSLUCENT RIBBON

Difusor: cristal óptico mate / Diffuser: optical matte glass diffuser

### ACABADOS / FINISHING

NÍQUEL SATINADO  
SATIN NICKEL

CROMO BRILLANTE  
BRILLIANT CHROME

GRIS GRAFITO  
GREY GRAPHITE

COTONET BLANCO  
WHITE COTTON

CINTA CREMA  
CREAM RIBBON

CINTA BLANCA  
WHITE RIBBON







278 **OLIVER**

DESIGN: SERGI DEVESA / ÒSCAR DEVESA 2013

**CINTA / PLAFÓN**  
**RIBBON / CEILING**

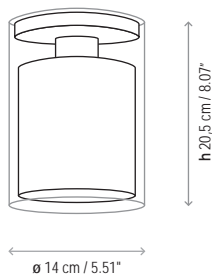

5131306 CROMO / CHROME

Pantalla 12 x 13 cm / Lampshade 4.72" x 5.12"

- P-734C CINTA TRANSLÚCIDA BLANCA / WHITE TRANSLUCENT RIBBON
- P-735C CINTA TRANSLÚCIDA CREMA / CREAM TRANSLUCENT RIBBON
- P-736C CINTA TRANSLÚCIDA ROJA / RED TRANSLUCENT RIBBON
- P-737C COTONET BLANCO / WHITE COTTON
- P-738C COTONET NEGRO / BLACK COTTON
- P-739C BLANCO INTERIOR NARANJA / WHITE-ORANGE INNER
- P-740C NEGRO INTERIOR NARANJA / BLACK-ORANGE INNER

Bombilla incluida / Bulb included  
Material: Vidrio borosilicato / Borosilicate glass



**FAMILIA / FAMILY**

pàg 254 278



**ACABADOS / FINISHING**

- CROMO BRILLANTE  
BRILLIANT CHROME
- CINTA CREMA  
CREAM RIBBON
- CINTA BLANCA  
WHITE RIBBON
- CINTA ROJA  
RED RIBBON
- COTONET BLANCO  
WHITE COTTON
- COTONET NEGRO  
COTTON BLACK
- COTONET BLANCO  
INTERIOR NARANJA  
COTTON WHITE  
ORANGE INSIDE
- COTONET NEGRO  
INTERIOR NARANJA  
COTTON BLACK  
ORANGE INSIDE







# PLAFONET

DESIGN: CARLES RIART / LLUÍS PORQUERAS / JOANA BOVER 2005

**CINTA / PLAFÓN**  
*RIBBON / CEILING*

## PLAFONET - 43 FONDA EUROPA

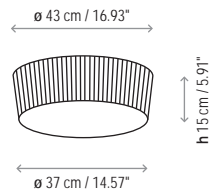

- 0124907 C LATÓN-CINTA TRANSLÚCIDA CREMA  
*BRASS-CREAM TRANSLUCENT RIBBON*
- 0124905 C INOX-CINTA TRANSLÚCIDA CREMA  
*INOX-CREAM TRANSLUCENT RIBBON*
- 0124907 B LATÓN-CINTA TRANSLÚCIDA BLANCA  
*BRASS-WHITE TRANSLUCENT RIBBON*
- 0124905 B INOX-CINTA TRANSLÚCIDA BLANCA  
*INOX-WHITE TRANSLUCENT RIBBON*
- 0124907 T LATÓN-COTONET BLANCO / *BRASS-WHITE COTTON*
- 0124905 T INOX-COTONET BLANCO / *INOX-WHITE COTTON*

Difusor cristal opal / *Diffuser opal glass*

## PLAFONET - 60 FONDA EUROPA

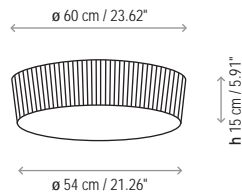

- 0224907 C LATÓN-CINTA TRANSLÚCIDA CREMA  
*BRASS-CREAM TRANSLUCENT RIBBON*
- 0224905 C INOX-CINTA TRANSLÚCIDA CREMA  
*INOX-CREAM TRANSLUCENT RIBBON*
- 0224907 B LATÓN-CINTA TRANSLÚCIDA BLANCA  
*BRASS-WHITE TRANSLUCENT RIBBON*
- 0224905 B INOX-CINTA TRANSLÚCIDA BLANCA  
*INOX-WHITE TRANSLUCENT RIBBON*
- 0224907 T LATÓN-COTONET BLANCO / *BRASS-WHITE COTTON*
- 0224905 T INOX-COTONET BLANCO / *INOX-WHITE COTTON*

Difusor cristal opal / *Diffuser opal glass*

## PLAFONET - 95 FONDA EUROPA

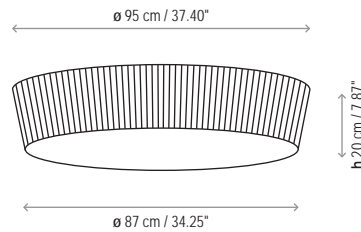
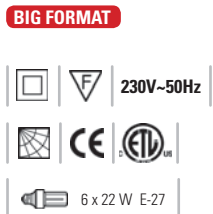

- 0324907 C LATÓN-CINTA TRANSLÚCIDA CREMA  
*BRASS-CREAM TRANSLUCENT RIBBON*
- 0324905 C INOX-CINTA TRANSLÚCIDA CREMA  
*INOX-CREAM TRANSLUCENT RIBBON*
- 0324907 B LATÓN-CINTA TRANSLÚCIDA BLANCA  
*BRASS-WHITE TRANSLUCENT RIBBON*
- 0324905 B INOX-CINTA TRANSLÚCIDA BLANCA  
*INOX-WHITE TRANSLUCENT RIBBON*
- 0324907 T LATÓN-COTONET BLANCO / *BRASS-WHITE COTTON*
- 0324905 T INOX-COTONET BLANCO / *INOX-WHITE COTTON*

Difusor de metacrilato opal / *Methacrylate opal diffuser*

### ACABADOS / FINISHING

LATÓN BRASS    INOX INOX    COTONET BLANCO WHITE COTTON    CINTA CREMA CREAM RIBBON    CINTA BLANCA WHITE RIBBON











# RONDO

DESIGN: JOANA BOVER 2007

## RONDO - F

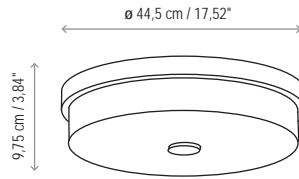

### CINTA / PLAFÓN RIBBON / CEILING

- 5015005F NÍQUEL SATINADO / SATIN NICKEL
- 5015006F CROMO BRILLANTE / BRILLIANT CHROME
- 5015008F GRIS GRAFITO / GRAPHITE GREY

Interior pantalla poliéster / Inner shade in polyester

- P-576 CINTA TRANSLÚCIDA BLANCA / WHITE TRANSLUCENT RIBBON
- P-577 CINTA TRANSLÚCIDA CREMA / CREAM TRANSLUCENT RIBBON
- P-578 COTONET BLANCO / WHITE COTTON

Difusor: Cristal óptico mate / Diffuser: optical matte glass diffuser

## RONDO - I

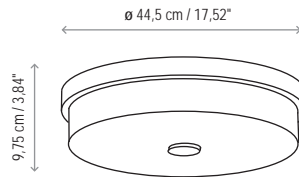

- 5015005I NÍQUEL SATINADO / SATIN NICKEL
- 5015006I CROMO BRILLANTE / BRILLIANT CHROME
- 5015008I GRIS GRAFITO / GRAPHITE GREY

Interior pantalla poliéster / Inner shade in polyester

- P-576 CINTA TRANSLÚCIDA BLANCA / WHITE TRANSLUCENT RIBBON
- P-577 CINTA TRANSLÚCIDA CREMA / CREAM TRANSLUCENT RIBBON
- P-578 COTONET BLANCO / WHITE COTTON

Difusor: Cristal óptico mate / Diffuser: optical matte glass diffuser

### ACABADOS / FINISHING

- NÍQUEL SATINADO / SATIN NICKEL
- CROMO BRILLANTE / BRILLIANT CHROME
- GRIS GRAFITO / GREY GRAPHITE
- COTONET BLANCO / WHITE COTTON
- CINTA CREMA / CREAM RIBBON
- CINTA BLANCA / WHITE RIBBON







**SIAM - 80**

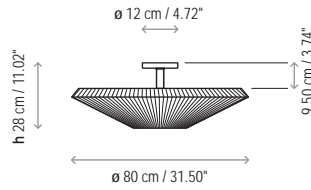

**CINTA / PLAFÓN**  
**RIBBON / CEILING**

- 0132005 ESTRUCTURA NÍQUEL SATINADO / SATIN NICKEL
- 0132001 ESTRUCTURA BLANCO 9010 CRUDO / WHITE 9010

Pantalla / Lampshade:

- P-686C CINTA TRANSLÚCIDA BLANCA / WHITE TRANSLUCENT RIBBON
- P-687C CINTA TRANSLÚCIDA CREMA / CREAM TRANSLUCENT RIBBON
- P-688C CINTA TRANSLÚCIDA ROJA / RED TRANSLUCENT RIBBON

**SIAM - 120** **BIG FORMAT**

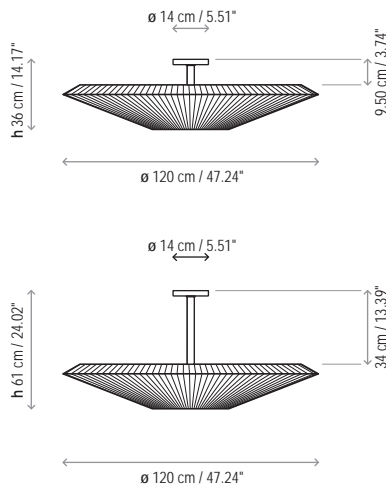
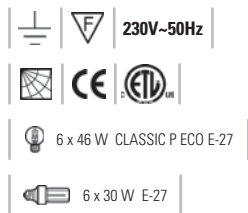

- 0232005P ESTRUCTURA NÍQUEL SATINADO / SATIN NICKEL
- 0232001P ESTRUCTURA BLANCO 9010 CRUDO / WHITE 9010
- 0232005G ESTRUCTURA GRANDE NÍQUEL SATINADO / SATIN NICKEL
- 0232001G ESTRUCTURA GRANDE BLANCO 9010 CRUDO / WHITE 9010

Pantalla / Lampshade:

- P-698C CINTA TRANSLÚCIDA BLANCA / WHITE TRANSLUCENT RIBBON
- P-699C CINTA TRANSLÚCIDA CREMA / CREAM TRANSLUCENT RIBBON
- P-700C CINTA TRANSLÚCIDA ROJA / RED TRANSLUCENT RIBBON

Este plafón permite realizar distintas composiciones individuales o en grupos. Existen dos medidas: Estructura 185 cm y Estructura 430 cm. Sobreponiendo las pantallas parcialmente, unas sobre las otras, conseguiremos crear un mural adecuado a cada espacio y necesidad.

*This ceiling lamp allows several individual or group compositions. Available in two sizes: 185 cm and 430 cm structure. Superimposing shades partially, one on another, we will obtain a mural suitable for each space and need.*

**FAMILIA / FAMILY**

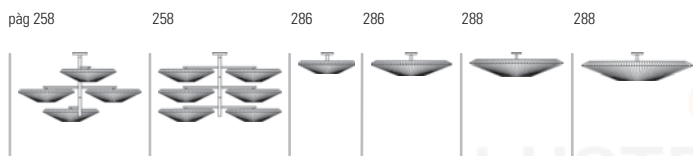



**ACABADOS / FINISHING**





**CINTA / PLAFÓN**  
**RIBBON / CEILING**

**SIAM - 150** **BIG FORMAT**

-   230V-50Hz
-  
-  6 x 46 W CLASSIC P ECO E-27
-  6 x 30 W E-27

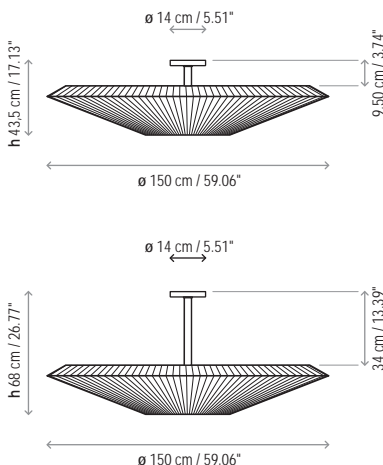

- 0532005P ESTRUCTURA NÍQUEL SATINADO / SATIN NICKEL
- 0532001P ESTRUCTURA BLANCO 9010 CRUDO / WHITE 9010
- 0532005G ESTRUCTURA GRANDE NÍQUEL SATINADO / SATIN NICKEL
- 0532001G ESTRUCTURA GRANDE BLANCO 9010 CRUDO / WHITE 9010

Pantalla / Lampshade:

- P-773C CINTA TRANSLÚCIDA BLANCA / WHITE TRANSLUCENT RIBBON
- P-774C CINTA TRANSLÚCIDA CREMA / CREAM TRANSLUCENT RIBBON
- P-775C CINTA TRANSLÚCIDA ROJA / RED TRANSLUCENT RIBBON

Este plafón permite realizar distintas composiciones individuales o en grupos. Existen dos medidas: Estructura 18,5 cm y Estructura 43 cm. Sobreponiendo las pantallas parcialmente, unas sobre las otras, conseguiremos crear un mural adecuado a cada espacio y necesidad.  
*This ceiling lamp allows several individual or group compositions. Available in two sizes: 18,5 cm and 43 cm structure. Superimposing shades partially, one on another, we will obtain a mural suitable for each space and need.*

**SIAM - 200** **BIG FORMAT**

-   230V-50Hz
-  
-  8 x 46 W CLASSIC P ECO E-27
-  8 x 30 W E-27
-  135 W LED | Led 135 W Phillips Lumens 10.100 lm Valor cromático / CRI 80 Grados Kelvin Degrees Kelvin 2600°

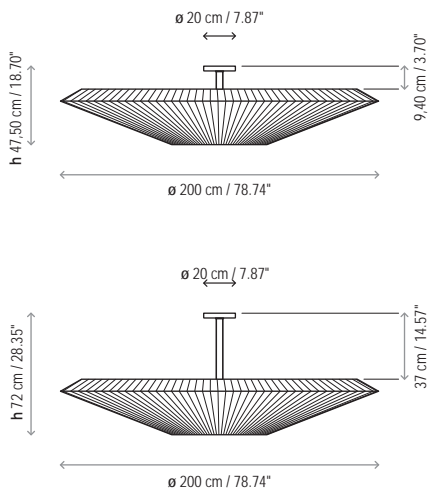

- 0332005P ESTRUCTURA 185 NÍQUEL SATINADO / SATIN NICKEL
- 0332001P ESTRUCTURA 185 BLANCO 9010 CRUDO / WHITE 9010
- 0332005G ESTRUCTURA 430 NÍQUEL SATINADO / SATIN NICKEL
- 0332001G ESTRUCTURA 430 BLANCO 9010 CRUDO / WHITE 9010

- D0332005LP ESTR.185 REGULABLE SISTEMA DALI - NÍQUEL SATINADO ESTR.185 DALI DIMMING SYSTEM - SATIN NICKEL
- D0332001LP ESTR.185 REGULABLE SISTEMA DALI - BLANCO 9010 CRUDO ESTR.185 DALI DIMMING SYSTEM - WHITE 9010
- D0332005LG ESTR.430 REGULABLE SISTEMA DALI - NÍQUEL SATINADO ESTR.430 DALI DIMMING SYSTEM - SATIN NICKEL
- D0332001LG ESTR.430 REGULABLE SISTEMA DALI - BLANCO 9010 CRUDO ESTR.430 DALI DIMMING SYSTEM - WHITE 9010

Pantalla / Lampshade:

- P-690C CINTA TRANSLÚCIDA BLANCA / WHITE TRANSLUCENT RIBBON
- P-691C CINTA TRANSLÚCIDA CREMA / CREAM TRANSLUCENT RIBBON
- P-692C CINTA TRANSLÚCIDA ROJA / RED TRANSLUCENT RIBBON
- P-690L CINTA TRANSLÚCIDA BLANCA / WHITE TRANSLUCENT RIBBON
- P-691L CINTA TRANSLÚCIDA CREMA / CREAM TRANSLUCENT RIBBON
- P-692L CINTA TRANSLÚCIDA ROJA / RED TRANSLUCENT RIBBON

Este plafón permite realizar distintas composiciones individuales o en grupos. Existen dos medidas: Estructura 185 cm y Estructura 430 cm. Sobreponiendo las pantallas parcialmente, unas sobre las otras, conseguiremos crear un mural adecuado a cada espacio y necesidad.  
*This ceiling lamp allows several individual or group compositions. Available in two sizes: 185 cm and 430 cm structure. Superimposing shades partially, one on another, we will obtain a mural suitable for each space and need.*

**FAMILIA / FAMILY**

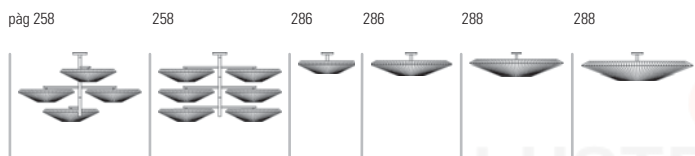

**ACABADOS / FINISHING**

















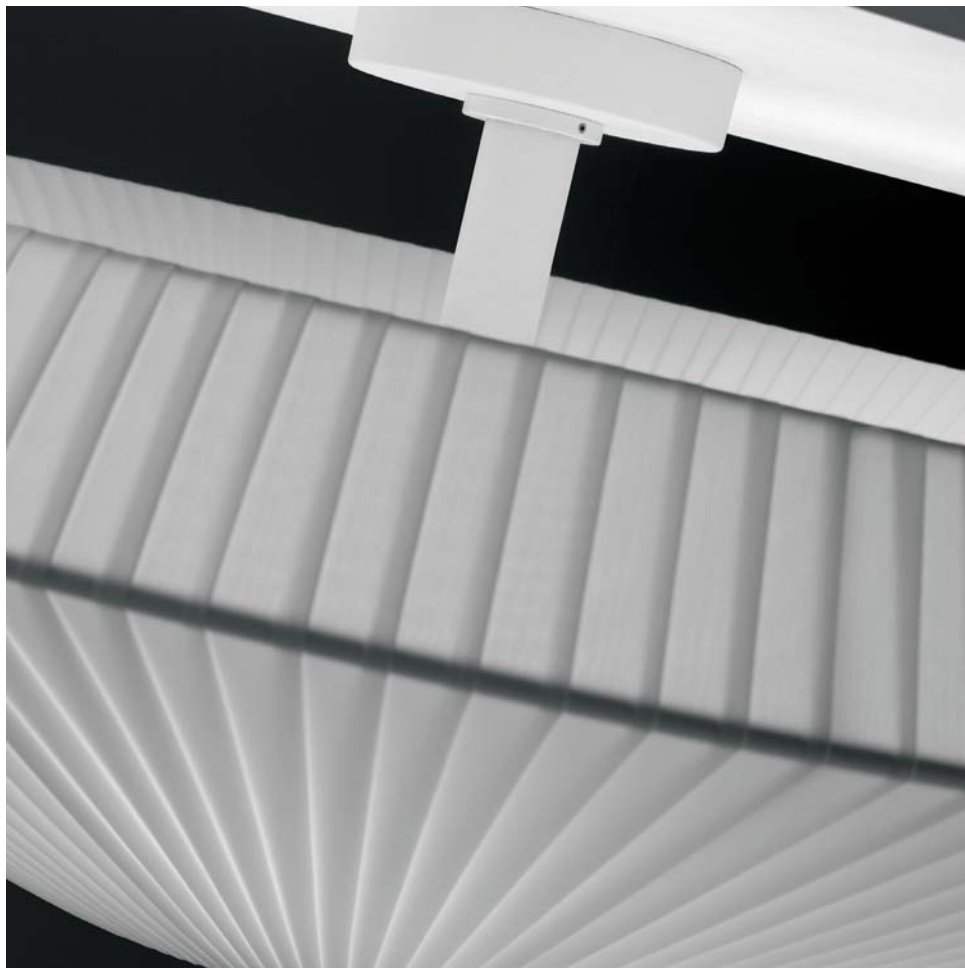





# URBAN

DESIGN: JOANA BOVER 2011

## URBAN - 37

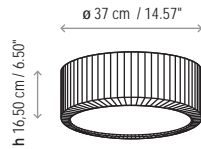
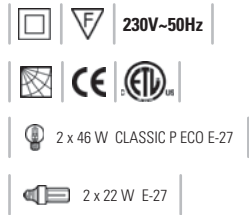

## URBAN - 60

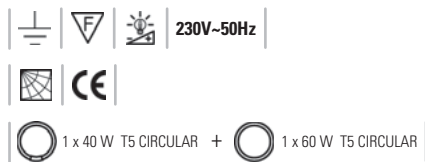
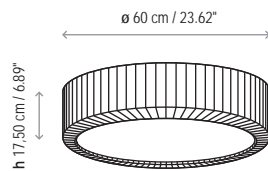
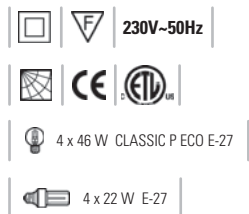

## URBAN - 90 **BIG FORMAT**

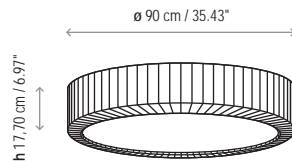

### CINTA / PLAFÓN RIBBON / CEILING

- 0132506B CROMO-CINTA TRANSLÚCIDA BLANCA  
CHROME-WHITE TRANSLUCENT RIBBON
- 0132506C CROMO-CINTA TRANSLÚCIDA CREMA  
CHROME-CREAM TRANSLUCENT RIBBON
- 0132506R CROMO-CINTA TRANSLÚCIDA ROJA  
CHROME-RED TRANSLUCENT RIBBON

- 0232506B CROMO-CINTA TRANSLÚCIDA BLANCA  
CHROME-WHITE TRANSLUCENT RIBBON
- 0232506C CROMO-CINTA TRANSLÚCIDA CREMA  
CHROME-CREAM TRANSLUCENT RIBBON
- 0232506R CROMO-CINTA TRANSLÚCIDA ROJA  
CHROME-RED TRANSLUCENT RIBBON

- D0232506B REGULABLE SISTEMA DALI/CROMO-CINTA TRANSL. BLANCA  
DALI DIMMING SYSTEM /CHROME-WHITE TRANSL. RIBBON
- D0232506C REGULABLE SISTEMA DALI/CROMO-CINTA TRANSL. CREMA  
DALI DIMMING SYSTEM /CHROME-CREAM TRANSL. RIBBON
- D0232506R REGULABLE SISTEMA DALI/CROMO-CINTA TRANSLÚCIDA ROJA  
DALI DIMMING SYSTEM /CHROME-RED TRANSLUCENT RIBBON

- 0432506B CROMO-CINTA TRANSLÚCIDA BLANCA  
CHROME-WHITE TRANSLUCENT RIBBON
- 0432506C CROMO-CINTA TRANSLÚCIDA CREMA  
CHROME-CREAM TRANSLUCENT RIBBON
- 0432506R CROMO-CINTA TRANSLÚCIDA ROJA  
CHROME-RED TRANSLUCENT RIBBON

- D0432506B REGULABLE SISTEMA DALI/CROMO-CINTA TRANSL. BLANCA  
DALI DIMMING SYSTEM /CHROME-WHITE TRANSL. RIBBON
- D0432506C REGULABLE SISTEMA DALI/CROMO-CINTA TRANSL. CREMA  
DALI DIMMING SYSTEM /CHROME-CREAM TRANSL. RIBBON
- D0432506R REGULABLE SISTEMA DALI/CROMO-CINTA TRANSL. ROJA  
DALI DIMMING SYSTEM /CHROME-RED TRANSL. RIBBON

### FAMILIA / FAMILY

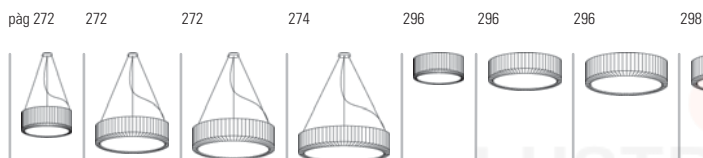

### ACABADOS / FINISHING

- CROMO BRILLANTE  
BRILLIANT CHROME
- CINTA CREMA  
CREAM RIBBON
- CINTA BLANCA  
WHITE RIBBON
- CINTA ROJA  
RED RIBBON









# URBAN

DESIGN: JOANA BOVER 2011

## URBAN - 120 **BIG FORMAT**

230V-50Hz

CE ETL

6 x 36 W 2G11

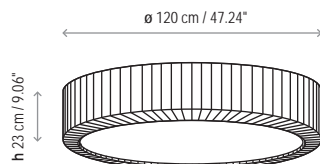

### CINTA / PLAFÓN RIBBON / CEILING

0332506B CROMO-CINTA TRANSLÚCIDA BLANCA  
*CHROME-WHITE TRANSLUCENT RIBBON*

0332506C CROMO-CINTA TRANSLÚCIDA CREMA  
*CHROME-CREAM TRANSLUCENT RIBBON*

0332506R CROMO-CINTA TRANSLÚCIDA ROJA  
*CHROME-RED TRANSLUCENT RIBBON*

D0332506B REGULABLE SISTEMA DALI/CROMO-CINTA TRANSL. BLANCA  
*DALI DIMMING SYSTEM /CHROME-WHITE TRANSL. RIBBON*

D0332506C REGULABLE SISTEMA DALI/CROMO-CINTA TRANSL. CREMA  
*DALI DIMMING SYSTEM /CHROME-CREAM TRANSL. RIBBON*

D0332506R REGULABLE SISTEMA DALI/CROMO-CINTA TRANSLÚCIDA ROJA  
*DALI DIMMING SYSTEM /CHROME-RED TRANSLUCENT RIBBON*



### FAMILIA / FAMILY

pàg 272 272 272 274 296 296 296 298



### ACABADOS / FINISHING

CROMO BRILLANTE  
*BRIGHT CHROME* CINTA CREMA  
*CREAM RIBBON* CINTA BLANCA  
*WHITE RIBBON* CINTA ROJA  
*RED RIBBON*





# CARLOTA

DESIGN: JOANA BOVER 2003

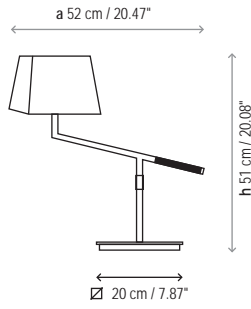

## CINTA / MESA RIBBON / TABLE LAMP

- 1924005 NÍQUEL SATINADO / SATIN NICKEL
- 1924006 CROMO BRILLANTE / BRILLIANT CHROME
- 1924060 NÍQUEL PIEL OSCURA / NICKEL DARK LEATHER
- 1924061 NÍQUEL PIEL CLARA / NICKEL CARAMEL LEATHER

Pantalla cuadrada 20 x 15 x 10 cm / Square lampshade 7.87" x 5.91" x 3.94"

- P-107 COTONET / COTTON
- P-202 CINTA TRANSLÚCIDA BLANCA / WHITE TRANSLUCENT RIBBON
- P-203 CINTA TRANSLÚCIDA CREMA / CREAM TRANSLUCENT RIBBON

Brazo móvil / Swivel arm

## ACABADOS / FINISHING

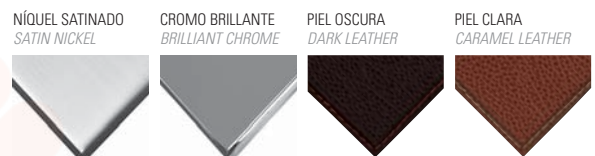

## FAMILIA / FAMILY

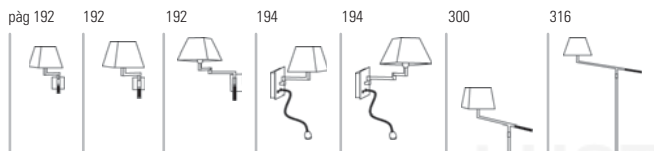





## DANONA - MINI

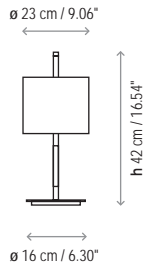

## CINTA / MESA RIBBON / TABLE LAMP

- 2023105 NÍQUEL SATINADO / SATIN NICKEL
- 2023160 NÍQUEL PIEL OSCURA / NICKEL DARK LEATHER
- 2023161 NÍQUEL PIEL CLARA / NICKEL CAMEL LEATHER

Pantalla 23 x 17 x 23 cm / Lampshade 9.06" x 6.69" x 9.06"  
Incluye difusor metacrilato + componentes pantalla  
Lampshade components and methacrylate diffuser included

- P-230 COTONET / COTTON
- P-003 CINTA TRANSLÚCIDA CREMA / CREAM TRANSLUCENT RIBBON
- P-004 CINTA TRANSLÚCIDA BLANCA / WHITE TRANSLUCENT RIBBON

## DANONA - MESA

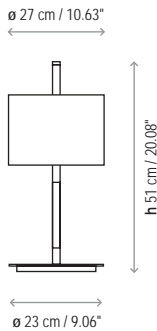

- 2123105 NÍQUEL SATINADO / SATIN NICKEL
- 2123160 NÍQUEL PIEL OSCURA / NICKEL DARK LEATHER
- 2123161 NÍQUEL PIEL CLARA / NICKEL CAMEL LEATHER

Pantalla 27 x 18 x 27 cm / Lampshade 10.63" x 7.09" x 10.63"  
Incluye difusor metacrilato + componentes pantalla  
Lampshade components and methacrylate diffuser included

- P-227 COTONET / COTTON
- P-005 CINTA TRANSLÚCIDA CREMA / CREAM TRANSLUCENT RIBBON
- P-006 CINTA TRANSLÚCIDA BLANCA / WHITE TRANSLUCENT RIBBON

## FAMILIA / FAMILY

pàg 222 222 302 302 318

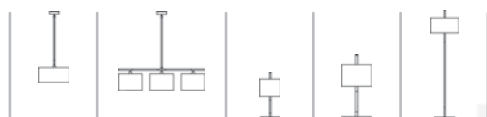

## ACABADOS / FINISHING

NÍQUEL SATINADO SATIN NICKEL    PIEL OSCURA DARK LEATHER    PIEL CLARA CAMEL LEATHER    COTONET COTTON    CINTA CREMA CREAM RIBBON    CINTA BLANCA WHITE RIBBON

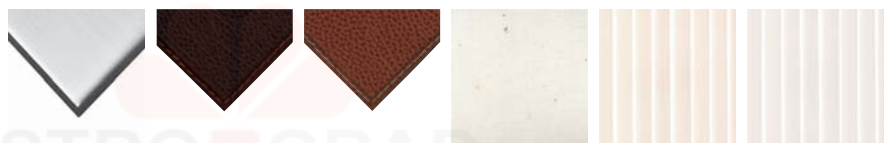







**CINTA / MESA**  
**RIBBON / TABLE LAMP**



1 x 46 W CLASSIC P ECO E-27

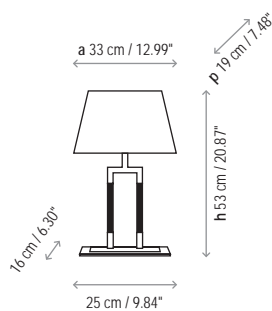

- 2119405 NÍQUEL SATINADO / SATIN NICKEL
- 2119460 NÍQUEL PIEL OSCURA / NICKEL DARK LEATHER
- 2119461 NÍQUEL PIEL CLARA / NICKEL CARAMEL LEATHER

**BASE INOX / INOX BASE**

Acabado: Níquel satinado – Cromo brillante  
Finish: Satin nickel – Brilliant chrome

Pantalla rectangular 33 x 19 x 21 cm  
Rectangular lampshade 12.99" x 7.48" x 8.27"

- P-478 LINO / LINEN
- P-479 COTONET / COTTON

**FAMILIA / FAMILY**

pàg 304 320



**ACABADOS / FINISHING**

- NÍQUEL SATINADO / SATIN NICKEL
- CROMO BRILLANTE / BRILLIANT CHROME
- PIEL OSCURA / DARK LEATHER
- PIEL CLARA / CARAMEL LEATHER
- COTONET / COTTON
- LINO / LINEN





**GIBSI - 01 / 02 / 03**

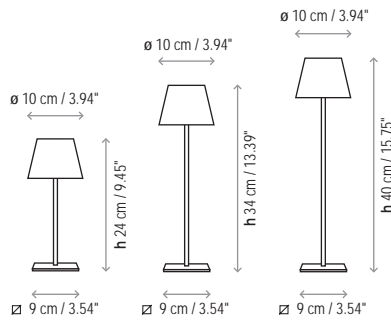

- 2018204 HIERRO NEGRO / BLACK IRON
- 2018205 NÍQUEL SATINADO / SATIN NICKEL
- 2118204 HIERRO NEGRO / BLACK IRON
- 2118205 NÍQUEL SATINADO / SATIN NICKEL
- 2218204 HIERRO NEGRO / BLACK IRON
- 2218205 NÍQUEL SATINADO / SATIN NICKEL

Pantalla cuadrada 10 x 9 x 7 cm  
Square lampshade 3.94" x 3.54" x 2.76"

- P-459 CINTA TRANSLÚCIDA BLANCA / WHITE TRANSLUCENT RIBBON
- P-460 COTONET NEGRO / BLACK COTTON
- P-463 CINTA TRANSLÚCIDA CREMA / CREAM TRANSLUCENT RIBBON
- P-464 COTONET / COTTON
- P-465 CINTA TRANSLÚCIDA ROJA / RED TRANSLUCENT RIBBON

(\* ) Aconsejamos un uso máximo ininterrumpido de 4/ 5 horas debido al tamaño de las pantallas.  
It is not recommended longer non-stop use of 4/5 hours due to the shade's measures.



**ACABADOS / FINISHING**

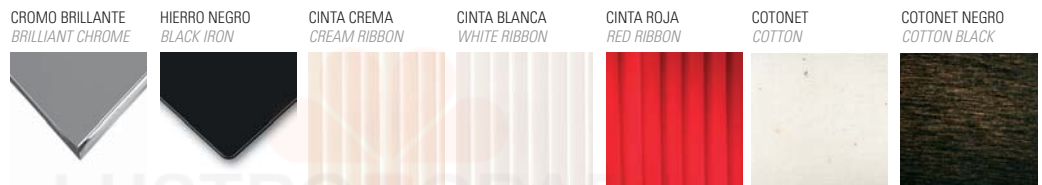





# MANI

DESIGN: TALLER / ESTUDI BOVER 1997

## MANI - MINI

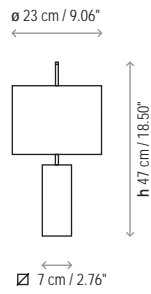

## CINTA / MESA RIBBON / TABLE LAMP

- 2028510 NÍQUEL BLANCO LACADO / NICKEL WHITE LACQUER
- 2028512 NÍQUEL HAYA NATURAL / NICKEL NATURAL WOOD
- 2028513 NÍQUEL HAYA CEREZO / NICKEL CHERRY WOOD
- 2028514 NÍQUEL HAYA WENGUE / NICKEL WALNUT WOOD

Pantalla 23 x 17 x 23 cm / Lampshade 9.06" x 6.69" x 9.06"  
Incluye difusor metacrilato + componentes pantalla  
Lampshade components and methacrylate diffuser included

- P-003 CINTA TRANSLÚCIDA CREMA / CREAM TRANSLUCENT RIBBON
- P-004 CINTA TRANSLÚCIDA BLANCA / WHITE TRANSLUCENT RIBBON
- P-230 COTONET / COTTON

## MANI - MESA

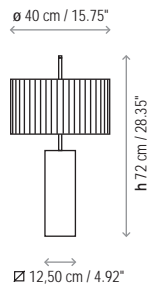

- 2128510 NÍQUEL BLANCO LACADO / NICKEL WHITE LACQUER
- 2128512 NÍQUEL HAYA NATURAL / NICKEL NATURAL WOOD
- 2128513 NÍQUEL HAYA CEREZO / NICKEL CHERRY WOOD
- 2128514 NÍQUEL HAYA WENGUE / NICKEL WALNUT WOOD

Pantalla 40 x 22 x 40 cm / Lampshade 15.75" x 8.66" x 15.75"  
Incluye difusor metacrilato + componentes pantalla  
Lampshade components and methacrylate diffuser included

- P-133 COTONET / COTTON
- P-137 CINTA TRANSLÚCIDA BLANCA / WHITE TRANSLUCENT RIBBON
- P-138 CINTA TRANSLÚCIDA CREMA / CREAM TRANSLUCENT RIBBON



MINI / BEDSIDE



MESA / TABLE

### ACABADOS / FINISHING

NÍQUEL SATINADO  
SATIN NICKEL

COTONET  
COTTON

CINTA CREMA  
CREAM RIBBON

CINTA BLANCA  
WHITE RIBBON

HAYA NATURAL  
NATURAL WOOD

HAYA CEREZO  
CHERRY WOOD

HAYA WENGUE  
WALNUT WOOD









# MEI OVAL

DESIGN: JOANA BOVER 2007

## MEI OVAL - T

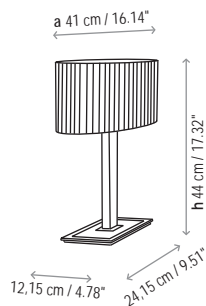

## MEI OVAL - T/USB

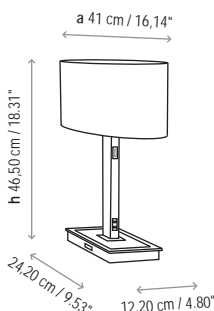

## MEI OVAL - T2/USB

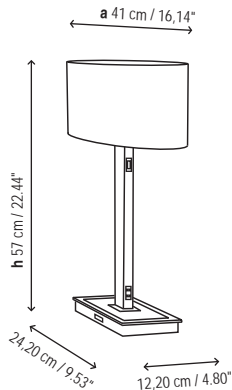

## FAMILIA / FAMILY

pàg 200 200 248 310 310 310 324



## CINTA / MESA RIBBON / TABLE LAMP

2125017 NÍQUEL CRISTAL NEGRO / NICKEL BLACK GLASS  
2125023 CROMO CRISTAL NEGRO / CHROME BLACK GLASS

Pantalla oval 41 x 17,5 x 15 cm / Oval lampshade 16.14" x 6.89" x 5.91"

P-551D CINTA TRANSLÚCIDA BLANCA / WHITE TRANSLUCENT RIBBON  
P-552D CINTA TRANSLÚCIDA CREMA / CREAM TRANSLUCENT RIBBON  
P-553D CINTA TRANSLÚCIDA NEGRA / BLACK TRANSLUCENT RIBBON  
P-554D COTONET BLANCO / WHITE COTTON

Difusor superior cristal negro / Upper diffuser black glass

2125017USB NÍQUEL CRISTAL NEGRO / NICKEL BLACK GLASS  
2125023USB CROMO CRISTAL NEGRO / CHROME BLACK GLASS

Pantalla oval 41 x 17,5 x 15 cm / Oval lampshade 16.14" x 6.89" x 5.91"

P-551D CINTA TRANSLÚCIDA BLANCA / WHITE TRANSLUCENT RIBBON  
P-552D CINTA TRANSLÚCIDA CREMA / CREAM TRANSLUCENT RIBBON  
P-553D CINTA TRANSLÚCIDA NEGRA / BLACK TRANSLUCENT RIBBON  
P-554D COTONET BLANCO / WHITE COTTON

Difusor superior cristal negro / Upper diffuser black glass

Interruptor de encendido situado en el mástil / On/off switch located on the stem  
Enchufe situado en el mástil / Switch located on the stem  
Entrada conector USB en la base / USB port located on the base

4125017USB NÍQUEL CRISTAL NEGRO / NICKEL BLACK GLASS  
4125023USB CROMO CRISTAL NEGRO / CHROME BLACK GLASS

Pantalla oval 41 x 20 x 15 cm / Oval lampshade 16.14" x 7.87" x 5.91"

P-805D CINTA TRANSLÚCIDA BLANCA / WHITE TRANSLUCENT RIBBON  
P-806D CINTA TRANSLÚCIDA CREMA / CREAM TRANSLUCENT RIBBON  
P-807D CINTA TRANSLÚCIDA NEGRA / BLACK TRANSLUCENT RIBBON  
P-808D COTONET BLANCO / WHITE COTTON

Difusor superior cristal negro / Upper diffuser black glass

Interruptor de encendido situado en el mástil / On/off switch located on the stem  
Enchufe situado en el mástil / Switch located on the stem  
Entrada conector USB en la base / USB port located on the base

## ACABADOS / FINISHING

NÍQUEL SATINADO SATIN NICKEL CROMO BRILLANTE BRILLIANT CHROME CRISTAL NEGRO BLACK GLASS



CINTA CREMA CREAM RIBBON CINTA BLANCA WHITE RIBBON CINTA NEGRA BLACK RIBBON COTONET BLANCO WHITE COTTON





**TAU - MINI**

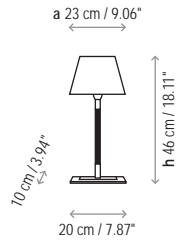

**CINTA / MESA**  
**RIBBON / TABLE LAMP**

- 2023960 NÍQUEL PIEL OSCURA / NICKEL DARK LEATHER
- 2023961 NÍQUEL PIEL CLARA / NICKEL CARAMEL LEATHER
- 2023905 NÍQUEL SATINADO CROMO / SATIN NICKEL CHROME

BASE INOX: Níquel satinado-Cromo brillante  
INOX BASE: Satin nickel-Brilliant chrome  
Pantalla rectangular 23 x 13 x 15 cm  
Rectangular lampshade 9.06" x 5.12" x 5.91"

- P-474 LINO / LINEN
- P-475 COTONET / COTTON
- P-671 CINTA TRANSLÚCIDA BLANCA / WHITE TRANSLUCENT RIBBON
- P-672 CINTA TRANSLÚCIDA CREMA / CREAM TRANSLUCENT RIBBON

**TAU - MESA**

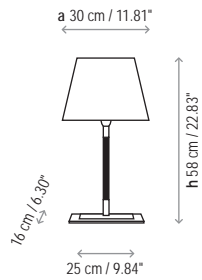

- 2223960 NÍQUEL PIEL OSCURA / NICKEL DARK LEATHER
- 2223961 NÍQUEL PIEL CLARA / NICKEL CARAMEL LEATHER
- 2223905 NÍQUEL SATINADO CROMO / SATIN NICKEL-CHROME

BASE INOX: Níquel satinado-Cromo brillante  
INOX BASE: Satin nickel-Brilliant chrome  
Pantalla rectangular 33 x 22 x 21 cm  
Rectangular lampshade 12.99" x 8.66" x 8.27"

- P-478 LINO / LINEN
- P-479 COTONET / COTTON
- P-674 CINTA TRANSLÚCIDA BLANCA / WHITE TRANSLUCENT RIBBON
- P-675 CINTA TRANSLÚCIDA CREMA / CREAM TRANSLUCENT RIBBON

**ACABADOS / FINISHING**



**FAMILIA / FAMILY**







# 314 TAU MADERA

DESIGN: JOANA BOVER 2002

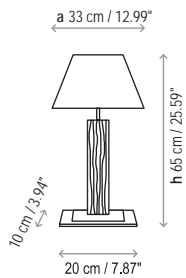

## CINTA / MESA RIBBON / TABLE LAMP

- 2123901 NÍQUEL BLANCO LACADO / NICKEL WHITE LACQUER
- 2123931 NÍQUEL CEREZO / NICKEL CHERRY
- 2123932 NÍQUEL WENGUÉ / NICKEL WENGUE
- 2123934 NÍQUEL CEBRANO / NICKEL CEBRANO

### BASE INOX / INOX BASE

Acabado: Níquel satinado–Cromo brillante  
Finish: Satin nickel–Brilliant chrome

Pantalla rectangular 33 x 22 x 21 cm

Rectangular lampshade 12.99" x 8.66" x 8.27"

- P-478 LINO / LINEN
- P-479 COTONET / COTTON
- P-541 COTONET BLANCO / WHITE COTTON
- P-674 CINTA TRANSLÚCIDA BLANCA / WHITE TRANSLUCENT RIBBON
- P-675 CINTA TRANSLÚCIDA CREMA / CREAM TRANSLUCENT RIBBON



La madera de cebrano puede sufrir variaciones propias de su naturaleza, no considerándose imperfecciones sus betas o su color. Cada pieza es única por sus propiedades.

*Cebrano wood may undergo characteristic variations that are not considered to be imperfections in its grain or colour. Each piece is unique because of its properties.*



### ACABADOS / FINISHING

NÍQUEL SATINADO  
SATIN NICKEL

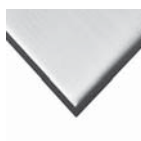

CROMO BRILLANTE  
BRILLIANT CHROME

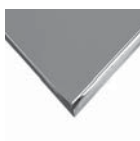

CEBRANO  
CEBRANO

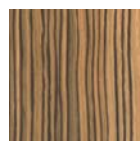

CEREZO  
CHERRY

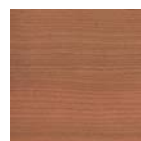

WENGUE  
WENGUE

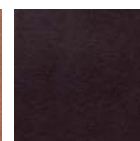

LACADO BLANCO  
WHITE LACQUER

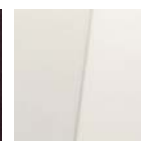

### FAMILIA / FAMILY

pàg 314 328



COTONET BLANCO  
WHITE COTTON



COTONET  
COTTON

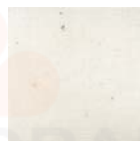

LINO  
LINEN



CINTA CREMA  
CREAM RIBBON



CINTA BLANCA  
WHITE RIBBON







# CARLOTA

DESIGN: JOANA BOVER 2003

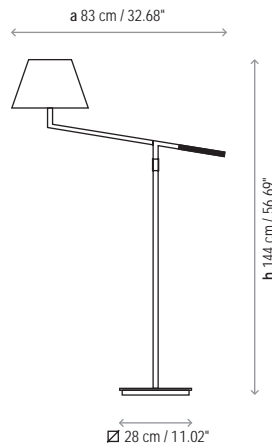

## CINTA / PIE RIBBON / FLOOR

- 3124005 NÍQUEL SATINADO / SATIN NICKEL
- 3124006 CROMO BRILLANTE / BRILLIANT CHROME
- 3124060 NÍQUEL PIEL OSCURA / NICKEL DARK LEATHER
- 3124061 NÍQUEL PIEL CLARA / NICKEL CARAMEL LEATHER

Pantalla cuadrada 27 x 21 x 15 cm / Square lampshade 10.63" x 8.27" x 5.91"

- P-453 COTONET / COTTON
- P-455 CINTA TRANSLÚCIDA BLANCA / WHITE TRANSLUCENT RIBBON
- P-456 CINTA TRANSLÚCIDA CREMA / CREAM TRANSLUCENT RIBBON

Brazo móvil / Swivel arm

## ACABADOS / FINISHING



## FAMILIA / FAMILY

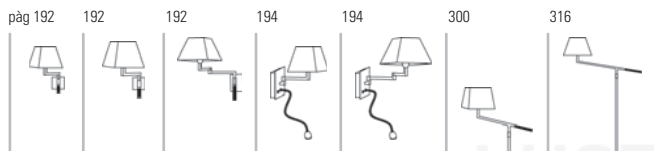



### CINTA / PIE RIBBON / FLOOR

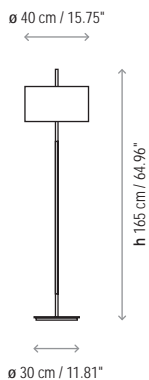
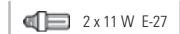

- 3023105 NÍQUEL SATINADO / SATIN NICKEL
- 3023160 NÍQUEL PIEL OSCURA / NICKEL DARK LEATHER
- 3023161 NÍQUEL PIEL CLARA / NICKEL CAMEL LEATHER

Pantalla 40 x 22 x 40 cm / Lampshade 15.75" x 8.66" x 15.75"  
 Incluye difusor metacrilato + componentes pantalla  
 Lampshade components and methacrylate diffuser included

- P-133 COTONET / COTTON
- P-137 CINTA TRANSLÚCIDA BLANCA / WHITE TRANSLUCENT RIBBON
- P-138 CINTA TRANSLÚCIDA CREMA / CREAM TRANSLUCENT RIBBON

#### FAMILIA / FAMILY



#### ACABADOS / FINISHING

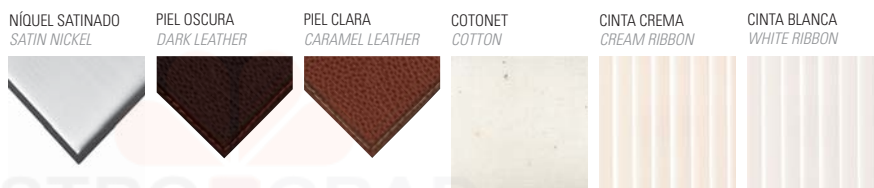





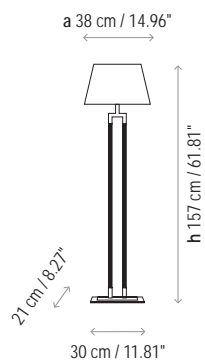

- 3019405 NÍQUEL SATINADO / SATIN NICKEL
- 3019460 NÍQUEL PIEL OSCURA / NICKEL DARK LEATHER
- 3019461 NÍQUEL PIEL CLARA / NICKEL CARAMEL LEATHER

**BASE INOX / INOX BASE**  
Acabado: Níquel satinado – Cromo brillante  
Finish: Satin nickel – Brilliant chrome

Pantalla rectangular 38 x 22 x 25 cm  
Rectangular lampshade 14.96" x 8.66" x 9.84"

- P-480 LINO / LINEN
- P-481 COTONET / COTTON

**FAMILIA / FAMILY**

pàg 304 320



**ACABADOS / FINISHING**

- NÍQUEL SATINADO SATIN NICKEL
- CROMO BRILLANTE BRILLIANT CHROME
- PIEL OSCURA DARK LEATHER
- PIEL CLARA CARAMEL LEATHER
- COTONET COTTON
- LINO LINEN









# MAXI

DESIGN: JOANA BOVER 2004

## MAXI - 01

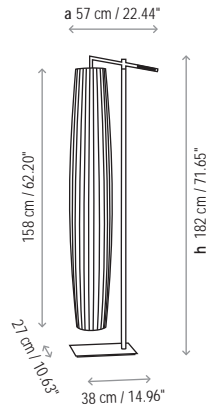

### CINTA / PIE RIBBON / FLOOR

- 3019505 NÍQUEL SATINADO / SATIN NICKEL
- 3019560 NÍQUEL PIEL OSCURA / NICKEL DARK LEATHER
- 3019561 NÍQUEL PIEL CLARA / NICKEL CARAMEL LEATHER

Pantalla 158 x 25 cm / Lampshade 62.20" x 9.84"

- P-771T CINTA CREMA / CREAM RIBBON
- P-772T CINTA BLANCA / WHITE RIBBON

## MAXI - 02

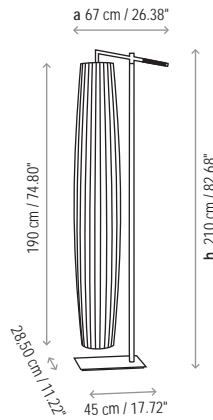
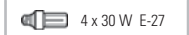

- 3219505 NÍQUEL SATINADO / SATIN NICKEL
- 3219560 NÍQUEL PIEL OSCURA / NICKEL DARK LEATHER
- 3219561 NÍQUEL PIEL CLARA / NICKEL CARAMEL LEATHER

Pantalla 190 x 30 cm / Lampshade 74.80" x 11.81"

- P-769T CINTA CREMA / CREAM RIBBON
- P-770T CINTA BLANCA / WHITE RIBBON



### FAMILIA / FAMILY

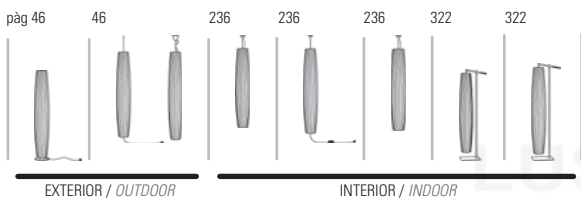

### ACABADOS / FINISHING





STRA...  
...E

# MEI OVAL

DESIGN: JOANA BOVER 2007

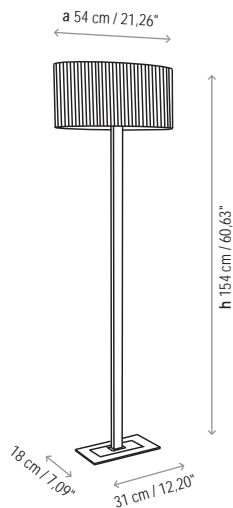

## CINTA / PIE RIBBON / FLOOR

- 3025017 NÍQUEL CRISTAL NEGRO / NICKEL BLACK GLASS
- 3025023 CROMO CRISTAL NEGRO / CHROME BLACK GLASS

Pantalla oval 54 x 24 x 23 cm / Oval lampshade 21.26" x 9.45" x 9.06"

- P-557 CINTA TRANSLÚCIDA BLANCA / WHITE TRANSLUCENT RIBBON
- P-558 CINTA TRANSLÚCIDA CREMA / CREAM TRANSLUCENT RIBBON
- P-559 CINTA TRANSLÚCIDA NEGRA / BLACK TRANSLUCENT RIBBON
- P-560 COTONET BLANCO / WHITE COTTON

## ACABADOS / FINISHING

- NÍQUEL SATINADO  
SATIN NICKEL
- CROMO BRILLANTE  
BRILLIANT CHROME
- CRISTAL NEGRO  
BLACK GLASS

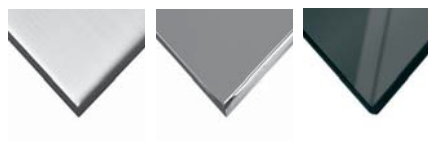

## FAMILIA / FAMILY

pàg 200 200 248 310 310 310 324



- CINTA CREMA  
CREAM RIBBON
- CINTA BLANCA  
WHITE RIBBON
- CINTA NEGRA  
BLACK RIBBON
- COTONET BLANCO  
WHITE COTTON







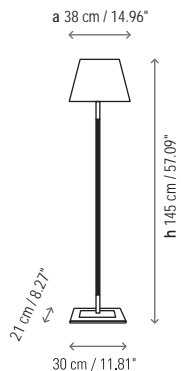

### CINTA / PIE RIBBON / FLOOR

- 3023960 NÍQUEL PIEL OSCURA / NICKEL DARK LEATHER
- 3023961 NÍQUEL PIEL CLARA / NICKEL CARAMEL LEATHER
- 3023905 NÍQUEL SATINADO CROMO / SATIN NICKEL-CHROME

#### BASE INOX / INOX BASE

Acabado: Níquel satinado–Cromo brillante

Finish: Satin nickel–Brilliant chrome

Pantalla rectangular 38 x 25 x 26 cm

Rectangular lampshade 14.96" x 9.84" x 10.24"

- P-480 LINO / LINEN
- P-481 COTONET / COTTON
- P-677 CINTA TRANSLÚCIDA BLANCA / WHITE TRANSLUCENT RIBBON
- P-678 CINTA TRANSLÚCIDA CREMA / CREAM TRANSLUCENT RIBBON

### FAMILIA / FAMILY

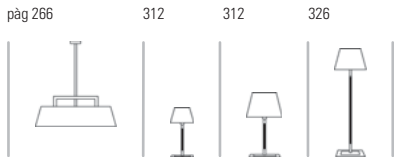

### ACABADOS / FINISHING









# 328 TAU MADERA

DESIGN: JOANA BOVER 2002

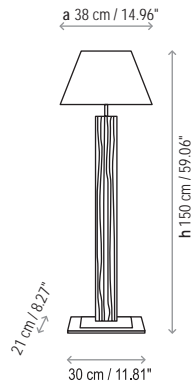

## CINTA / PIE RIBBON / FLOOR

- 3023901 NÍQUEL BLANCO LACADO / NICKEL WHITE LACQUER
- 3023931 NÍQUEL CEREZO / NICKEL CHERRY
- 3023932 NÍQUEL WENGUÉ / NICKEL WENGUE
- 3023934 NÍQUEL CEBRANO / NICKEL CEBRANO

### BASE INOX / INOX BASE

Acabado: Níquel satinado—Cromo brillante  
Finish: Satin nickel—Brilliant chrome

Pantalla rectangular 38 x 25 x 26 cm  
Rectangular lampshade 14.96" x 9.84" x 10.24"

- P-480 LINO / LINEN
- P-481 COTONET / COTTON
- P-542 COTONET BLANCO / WHITE COTTON
- P-677 CINTA TRANSLÚCIDA BLANCA / WHITE TRANSLUCENT RIBBON
- P-678 CINTA TRANSLÚCIDA CREMA / CREAM TRANSLUCENT RIBBON



La madera de cebrano puede sufrir variaciones propias de su naturaleza, no considerándose imperfecciones sus betas o su color. Cada pieza es única por sus propiedades.

*Cebrano wood may undergo characteristic variations that are not considered to be imperfections in its grain or colour. Each piece is unique because of its properties.*



### ACABADOS / FINISHING

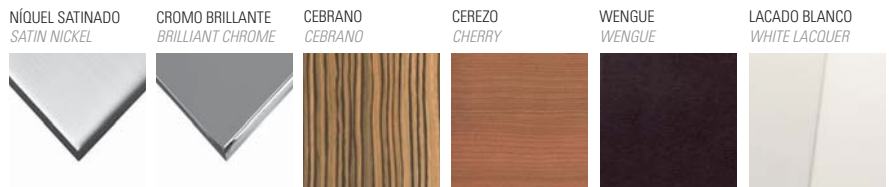

### FAMILIA / FAMILY

pàg 314 328

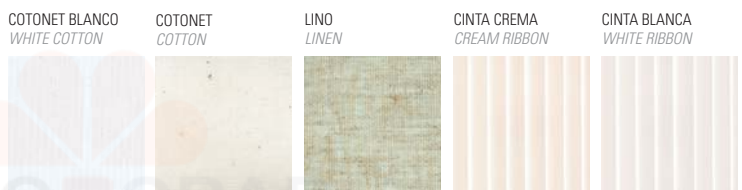









<https://www.lustrograd.com/vendors/bover/>

# **ARTESANAL** *HAND-CRAFTED*



LUSTRO GRAD

# AVANI

DESIGN: JOANA BOVER 1998

ARTESANAL / HAND-CRAFTED

## AVANI - MINI

APLIQUE ARTESANAL / HAND-CRAFTED WALL LAMP



2 x 46 W CLASSIC P ECO E-27

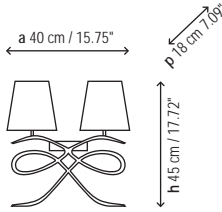

- 1222003 HIERRO MARRÓN GRAFITO / GRAPHITE BROWN IRON
- 1222004 HIERRO NEGRO / BLACK IRON

Pantalla 18 x 15 x 12 cm Precio unitario  
Lampshade 7.09" x 5.91" x 4.72" Unitary price

P-103 COTONET / COTTON

## AVANI - GRANDE

APLIQUE ARTESANAL / HAND-CRAFTED WALL LAMP



2 x 46 W CLASSIC P ECO E-27

2 x 11 W E-27

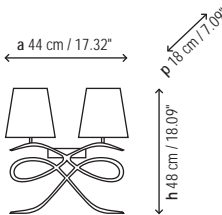

- 1222103 HIERRO MARRÓN GRAFITO / GRAPHITE BROWN IRON
- 1222104 HIERRO NEGRO / BLACK IRON

Pantalla 18 x 18 x 12 cm Precio unitario  
Lampshade 7.09" x 7.09" x 4.72" Unitary price

P-373 COTONET / COTTON

### ACABADOS / FINISHING

HIERRO MARRÓN  
BROWN IRON

HIERRO NEGRO  
BLACK IRON

COTONET  
COTTON







# FERRARA

DESIGN: JOANA BOVER 2002

ARTESANAL / HAND-CRAFTED

## FERRARA - 1 L

APLIQUE ARTESANAL / HAND-CRAFTED WALL LAMP

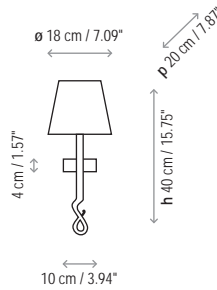

- 1124204 HIERRO NEGRO / BLACK IRON
- 1124203 HIERRO MARRÓN GRAFITO / GRAPHITE BROWN IRON

Pantalla 18 x 15 x 12 cm / Lampshade 7.09" x 5.91" x 4.72"

- P-103 COTONET / COTTON
- P-098 CINTA TRANSLÚCIDA BLANCA / WHITE TRANSLUCENT RIBBON
- P-099 CINTA TRANSLÚCIDA CREMA / CREAM TRANSLUCENT RIBBON

## FERRARA - 2 L

APLIQUE ARTESANAL / HAND-CRAFTED WALL LAMP

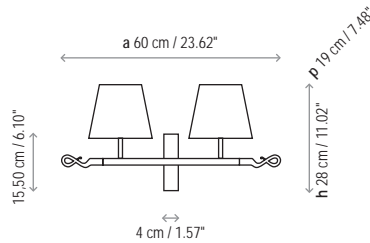

- 1224204 HIERRO NEGRO / BLACK IRON
- 1224203 HIERRO MARRÓN GRAFITO / GRAPHITE BROWN IRON

Pantalla 18 x 15 x 12 cm / Lampshade 7.09" x 5.91" x 4.72"

- P-103 COTONET / COTTON
- P-098 CINTA TRANSLÚCIDA BLANCA / WHITE TRANSLUCENT RIBBON
- P-099 CINTA TRANSLÚCIDA CREMA / CREAM TRANSLUCENT RIBBON

## FERRARA - 2 L

SUSPENSIÓN ARTESANAL  
HAND-CRAFTED PENDANT LAMP

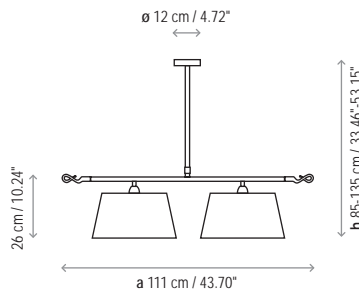

- 4224204 HIERRO NEGRO / BLACK IRON
- 4224203 HIERRO MARRÓN GRAFITO / GRAPHITE BROWN IRON

Pantalla 38 x 20 x 30 cm / Lampshade 14.96" x 7.87" x 11.81"

- P-163C COTONET / COTTON
- P-167C CINTA TRANSLÚCIDA CREMA / CREAM TRANSLUCENT RIBBON
- P-168C CINTA TRANSLÚCIDA BLANCA / WHITE TRANSLUCENT RIBBON

(\* ) Pantalla con difusor superior / The shade includes upper diffuser

### FAMILIA / FAMILY

pàg 334 334 334 338 338 338

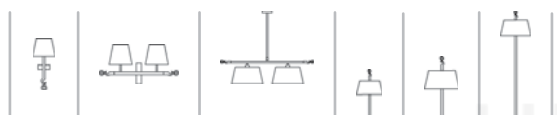

### ACABADOS / FINISHING

HIERRO MARRÓN BROWN IRON    HIERRO NEGRO BLACK IRON    COTONET COTTON    CINTA CREMA CREAM RIBBON    CINTA BLANCA WHITE RIBBON





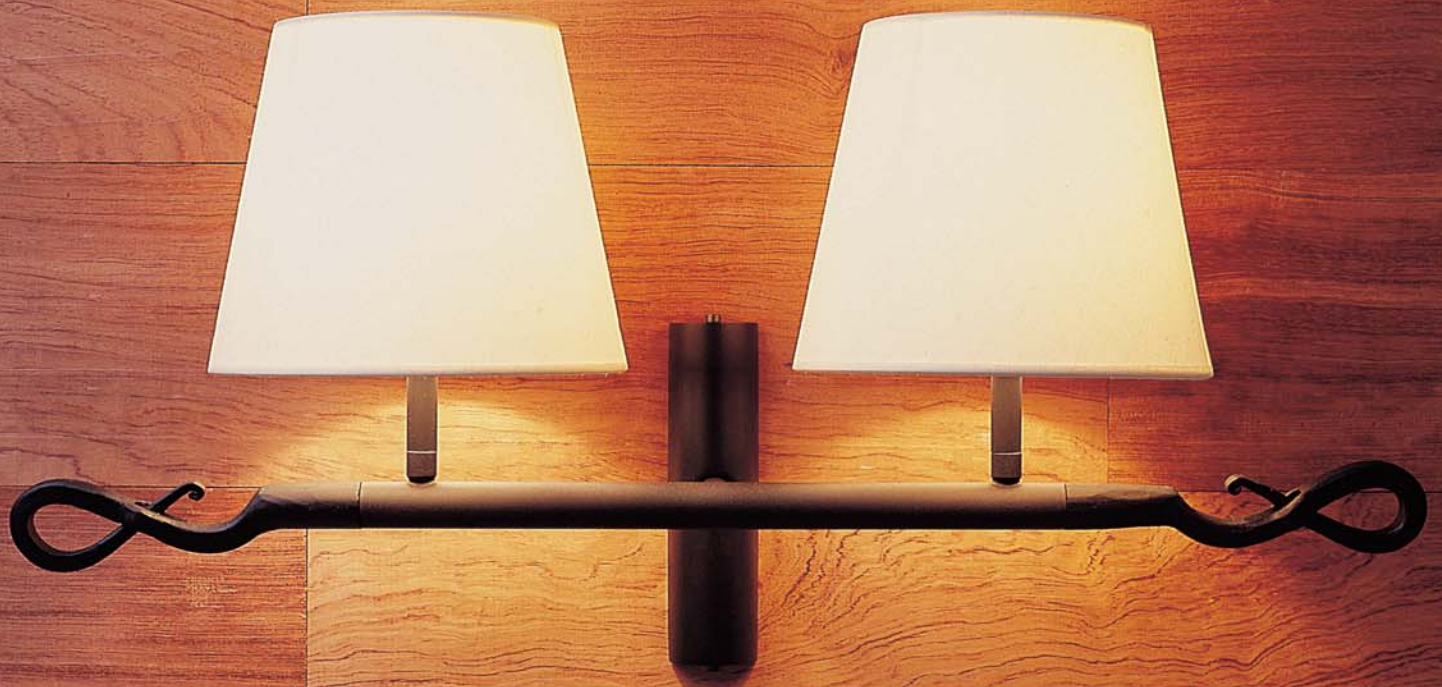









# FERRARA

DESIGN: JOANA BOVER 2002

ARTESANAL / HAND-CRAFTED

## FERRARA - MINI

MESA ARTESANAL / HAND-CRAFTED TABLE

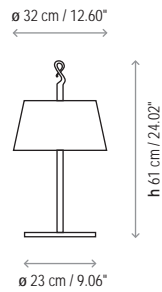

- 2124204 HIERRO NEGRO / BLACK IRON
- 2124203 HIERRO MARRÓN GRAFITO / GRAPHITE BROWN IRON

Pantalla 32 x 17 x 25 cm / Lampshade 12.60" x 6.69" x 9.84"

- P-445 CINTA TRANSLÚCIDA CREMA / CREAM TRANSLUCENT RIBBON
- P-446 CINTA TRANSLÚCIDA BLANCA / WHITE TRANSLUCENT RIBBON
- P-447 COTONET / COTTON

(\* ) Pantalla con difusor superior metacrilato  
Shade includes methacrylate upper diffuser

## FERRARA - MESA

MESA ARTESANAL / HAND-CRAFTED TABLE

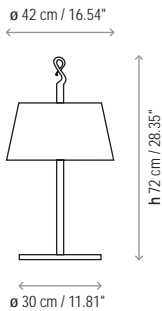

- 2224204 HIERRO NEGRO / BLACK IRON
- 2224203 HIERRO MARRÓN GRAFITO / GRAPHITE BROWN IRON

Pantalla 42 x 23 x 33 cm / Lampshade 16.54" x 9.06" x 12.99"

- P-435 COTONET / COTTON
- P-442 CINTA TRANSLÚCIDA BLANCA / WHITE TRANSLUCENT RIBBON
- P-443 CINTA TRANSLÚCIDA CREMA / CREAM TRANSLUCENT RIBBON

(\* ) Pantalla con difusor superior metacrilato  
Shade includes methacrylate upper diffuser

## FERRARA - PIE

PIE ARTESANAL / HAND-CRAFTED FLOOR

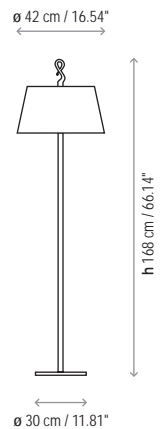

- 3024204 HIERRO NEGRO / BLACK IRON
- 3024203 HIERRO MARRÓN GRAFITO / GRAPHITE BROWN IRON

Pantalla 42 x 23 x 33 cm / Lampshade 16.54" x 9.06" x 12.99"

- P-435 COTONET / COTTON
- P-442 CINTA TRANSLÚCIDA BLANCA / WHITE TRANSLUCENT RIBBON
- P-443 CINTA TRANSLÚCIDA CREMA / CREAM TRANSLUCENT RIBBON

(\* ) Pantalla con difusor superior metacrilato  
Shade includes methacrylate upper diffuser

### FAMILIA / FAMILY

pàg 334 334 334 338 338 338



### ACABADOS / FINISHING

HIERRO MARRÓN BROWN IRON    HIERRO NEGRO BLACK IRON    COTONET COTTON    CINTA CREMA CREAM RIBBON    CINTA BLANCA WHITE RIBBON









**HEADQUARTERS OFFICES:**

**BOVER IL-LUMINACIÓ & MOBILIARI SL**

Avinguda Catalunya, 173  
Pol. Ind. Sud  
08440 Cardedeu  
Barcelona · Spain

Tels.: +34 93 871 31 52 / + 34 93 844 47 54  
Fax: +34 93 846 20 89  
e-mail: [info@bover.es](mailto:info@bover.es)  
e-mail: [export@bover.es](mailto:export@bover.es)  
[www.bover.es](http://www.bover.es)

**ALEMANIA & AUSTRIA**

[info@rooom.com](mailto:info@rooom.com)  
Tel.: +49 (89) 3589272-0

**FRANCIA**

[nuancesdiff@aol.com](mailto:nuancesdiff@aol.com)  
Tel.: +33 (0)561 853786

**POLONIA**

[goscia-jose@max.net.pl](mailto:goscia-jose@max.net.pl)  
Tel.: + 48601262172

**RUSIA**

[russia@bover.es](mailto:russia@bover.es)  
Tel.: +7 9036713131

**BOVER USA INC**

1231 Collier Road, Suite C  
Atlanta, GA 30318

Tel.: +1 (404) 924 2342  
[info@boverusa.com](mailto:info@boverusa.com)  
[www.boverusa.com](http://www.boverusa.com)