

bover

barcelona lights

General Catalogue
North America

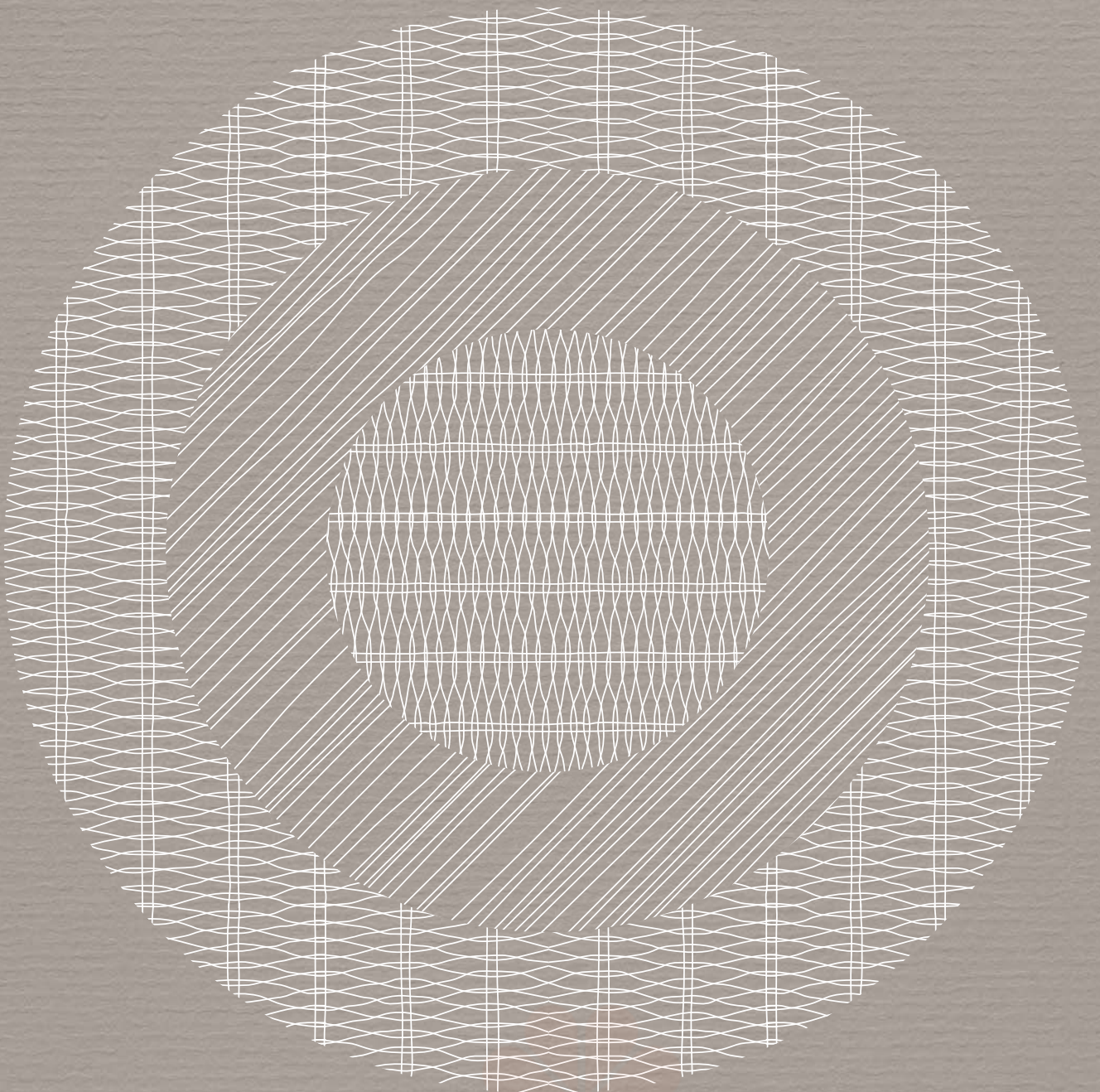

Los que vivimos cerca del Mediterráneo conocemos todos los matices de la luz.
Por eso cuando llega la noche la transformamos en pequeños espacios de día.

Wir, die in der Nähe des Mittelmeers leben, kennen alle Abstufungen des Lichts.
Wenn die Nacht kommt, verwandeln sie in kleine Punkte des Lichts.

Those of us who live near the Mediterranean know all the nuances of light.
For this reason, when night comes, we transform it into little spaces of day.

Mediterraneotik gertu bizi garenok ondo ezogutzen ditugu argiaren nabardura guztiak.
Horregatik, goua datorrenean egun bihurtzen dugu gure argi-gune txikien bitartez.

Ceux qui, comme nous, habitent près de la Méditerranée connaissent toutes les nuances de la lumière.
C'est pourquoi à la nuit tombée, nous la transformons en petits espaces de lumière.

Os que vivimos à beira do Mediterráneo conhecemos todos los matices da luz.
Por isso ao chegar a noite transformá-mos-la em pequenos espaços do día.

Noi che viviamo vicino al Mediterraneo conosciamo tutte le tonalità e le sfumature della luce.
Per questo quando cala la notte, la trasformiamo in piccoli spazi del giorno.

Quem vive perto do Mediterráneo conhece todas as nuances da luz.
Por isso, quando chega a noite, transformamo-la em pequenos espaços de día.

Lluís Porqueras

*Els que vivim prop de la Mediterrània,
coneixem tots els matisos de la llum.
Per això en arribar la nit la
transformem en petits espais de dia.*

Lluís Porqueras

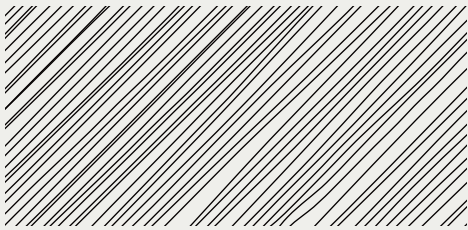

Editor / Publisher
Joana Bover

Disseny Gràfic / Graphic Designer
Miquel Llach

Fotografies / Photographers
Jordi Solé / J.E. Estudi Disseny
Befree Studio

Agraïments / Special Thanks
Mireia Sust / Hoteles Vincci
Hotel Nord 1901 / Girona
Danone / Barcelona
Cinta F. Camps / Hostal Empúries / L'Escala
Fonda Europa / Granollers
Hotel Villa Emilia / Barcelona
Restaurant Pasarela / La Roca Village
Coquinaria / Santa Agnès de Malanyanes
Farmàcia Mercè Carbonell / Cardedeu
Hotel SB Europa / Alado Decoració

Dipòsit Legal: 18084-09

Abril 2016

General Catalogue

North America

Made in Barcelona



Outdoor



Amphora, 10
Fora, 18
Garota, 34
Maxi, 48
Syra, 52

Contemporary

Wall Lamp



Alba, 60
BCN, 64
Club, 68
Flexo, 70
Flexo Lexa, 72
Garota, 74
Lea, 76
Liban, 80
Nón Lá, 82
Plana T5, 88
Spock, 90
Tria, 92
Twall, 100

Pendant Lamp



Cala, 102
Club, 106
Dome, 108
Elea, 114
Elipse, 120
Garota, 124
Hardy, 126
Inari, 130
Nón Lá, 134
Slend, 142
Syra, 150
Tibeta, 154

Ceiling



Cala, 160
Elea, 164
Garota, 168

Table Lamp



Club, 170
Garota, 172
Inari, 174
Muf, 176
Nón Lá, 178
Onne, 180
Spock, 184

Floor



Club, 188
Inari, 190
Spock, 192

Ribbon

Wall Lamp



Basik, 196
BCN, 198
Carlota, 204
Lexa, 208
Lexa - FL, 210
Mei Oval, 212
Silantra, 216
Wall Street - FL, 222
Wall Street, 224
Wall Street T5, 226

Pendant Lamp



Cornelia, 228
Danona, 234
Lámpara XVIII, 236
Lua, 240
Mar, 242
Marietta, 244
Maxi, 252
Mei, 258
Mei Oval, 266
Mos, 268
Oliver, 272
Siam, 276
Silantra, 280
Tau, 284
Tekno, 286
Urban, 290

Ceiling



Kuadrat, 294
Oliver, 296
Plafonet, 298
Rondo, 302
Siam, 304
Urban, 314

Table Lamp



Carlota, 318
Cornelia, 320
Danona, 324
Ema, 326
Mani, 328
Mei Oval, 330
Tau, 332
Tau Madera, 334

Floor



Carlota, 336
Danona, 338
Ema, 340
Maxi, 342
Mei Oval, 344
Tau, 346
Tau Madera, 348

Hand-Crafted

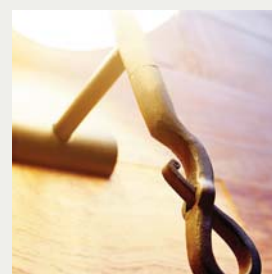

Avani, 352
Ferrara, 354



Alex Fernández Camps



Benedetta Tagliabue EMTB



Carles Riart



Christophe Mathieu



Gonzalo Milà



Joana Bover



Jordi Llopis



Jorge Pensi Design Studio



Lluís Porqueras



Luis Viñas



Rubén Saldaña



Sergi & Òscar Devesa



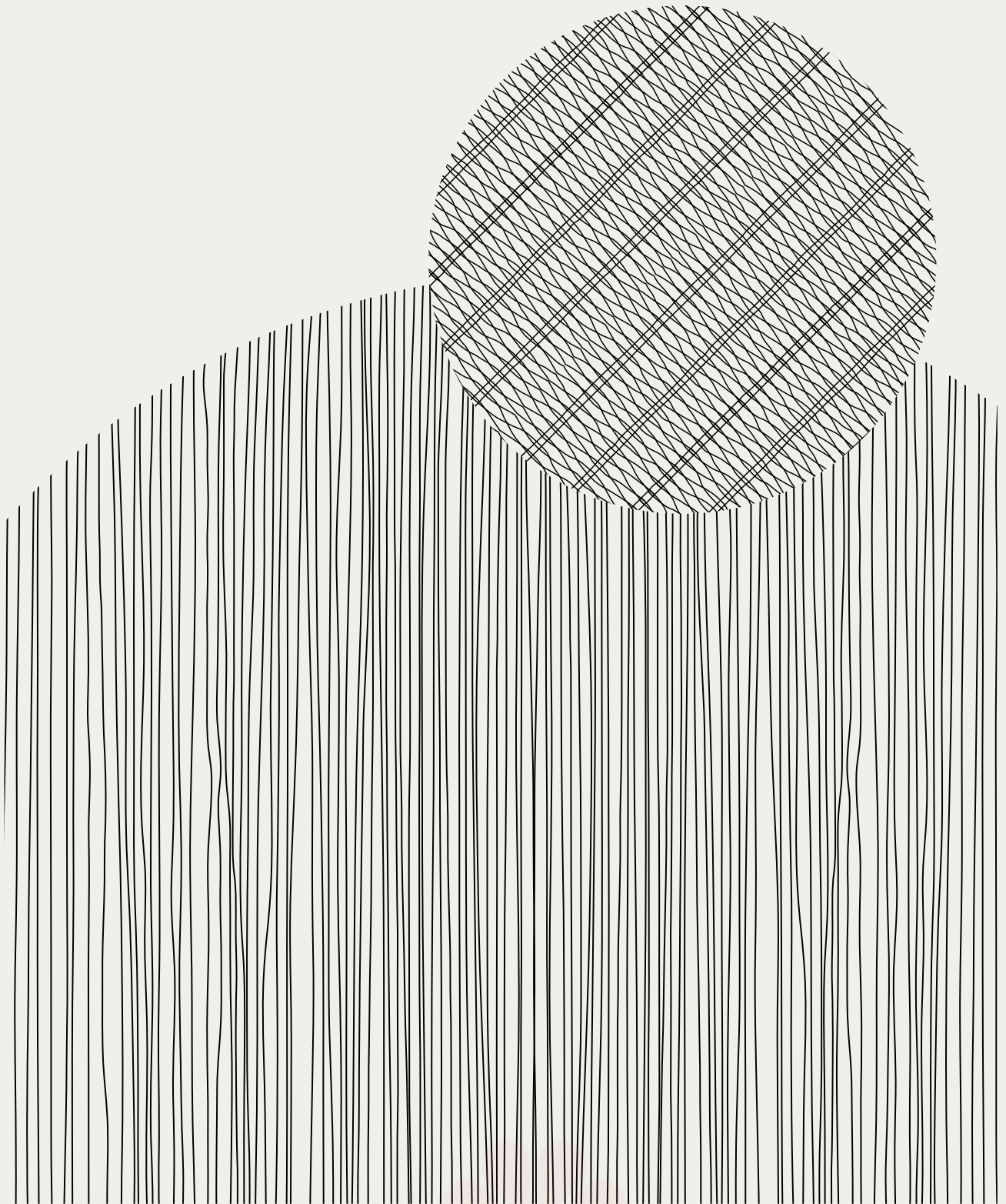

Outdoor



Outdoor

Amphora - 01

Outdoor Floor

	IP-55	120V~60Hz	
	2 x 20 W E26 Triple CFL		
	2 x 10 W E26 LED A19		
Dry + wet location			

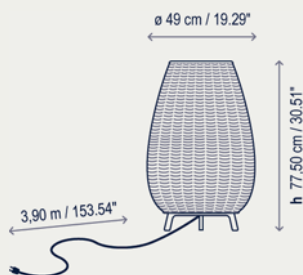

0133003U Brown Graphite Structure

P-741 Light Beige
P-742 Brown





Lampshade 19.29" x 27.36" - Synthetic Polyethylene Fiber
(Operating Temperature: -70°C To +70°C)
Lamp and shade structure made in aluminium

Light source is protected by polyethylene globe of medium density and UV protection
(Operating temperature: -40°C to +70°C)

Black wire, without switch

Amphora - 02

Outdoor Floor

	IP-55	120V~60Hz	
	2 x 29 W E26 Triple CFL		
	2 x 10 W E26 LED A19		
Dry + wet location			

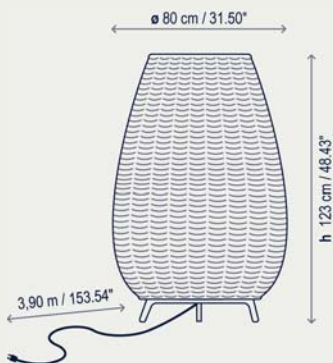

0233003U Brown Graphite Structure

P-744 Light Beige
P-745 Brown





Lampshade 31.50" x 44.69" - Synthetic Polyethylene Fiber
(Operating Temperature: -70°C To +70°C)
Lamp and shade structure made in aluminium

Light source is protected by polyethylene globe of medium density and UV resistant
(Operating temperature: -40°C to +70°C)

Black wire, without switch

Amphora - 03

Outdoor Floor

	IP-55	120V~60Hz	
	2 x 29 W E26 Triple CFL		
	2 x 10 W E26 LED A19		
Dry + wet location			

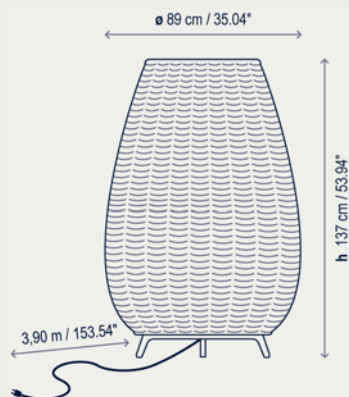

0333003U Brown Graphite Structure

P-747 Light Beige
P-748 Brown

Lampshade 35.04" x 50" - Synthetic Polyethylene Fiber
(Operating Temperature: -70°C To +70°C)
Lamp and shade structure made in aluminium

Light source is protected by polyethylene globe of medium density and UV protection
(Operating temperature: -40°C to +70°C)

Black wire, without switch

All Bover's synthetic fiber collection are recyclable and non-toxic for environmental sustainability.

Finishing

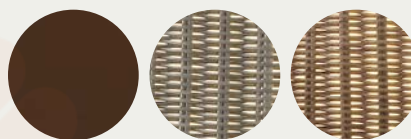

Brown graphite

Light beige

Brown

Amphora

by Alex Fernández Camps / Gonzalo Milà | 2013



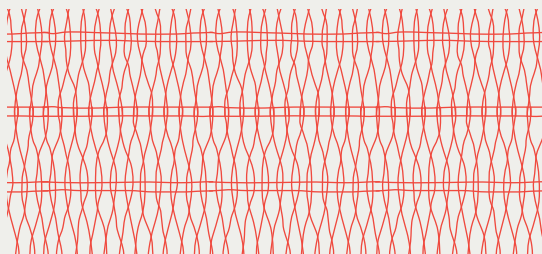

The AMPHORA collection has been designed to create a warm environment especially in outdoors. However, thanks to its highly decorative look, the Amphoras can equally be placed both in outdoor and indoor. The size and shape of this collection pay a subtle and discreet homage to the terracotta amphora formerly used for gardens and terraces decoration. In this collection we have used a synthetic fiber to make up big handmade baskets as shades with a tripod base subjected to a cataphoresis treatment. The light source is located inside the polyethylene ellipse which grants its water tightness. The light emitted by the Amphora collection is full of nuances and shapes avoiding glare.



Hotel Vincci Bit / Barcelona

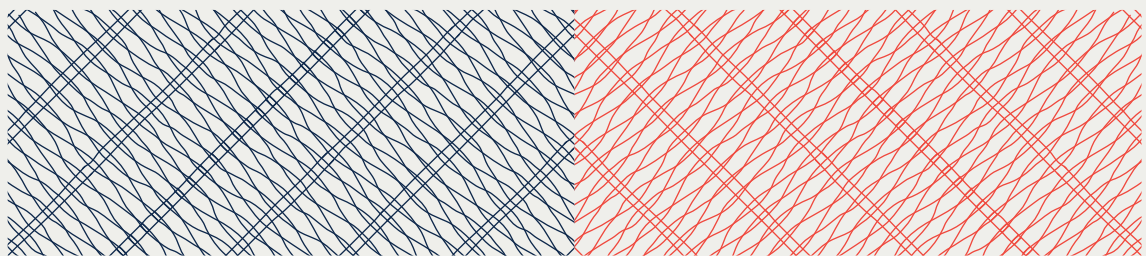



Restaurant Pasarela / La Roca Village





Outdoor

Fora - T

Outdoor Table Lamp

-  IP-55 | 120V-60Hz
-  
-  2 x 20 W E26 TRIPLE CFL
-  2 x 10 W E26 A19 LED
- Dry + wet location

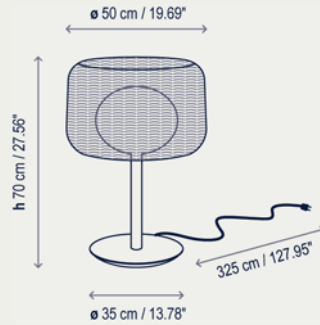

Sets

2230301U Natural White
P-695 Light Beige

2230303U Brown Graphite
P-696 Brown





Lampshade 19.69" x 11.81" - Synthetic Polyethylene Fiber
(Operating temperature: -70°C to +70°C)
Shade structure made in aluminium.

Light source is protected by polyethylene globe of medium density and UV protection (Operating temperature: -40°C to +70°C).

Black wire without switch

Fora - P

Outdoor Floor Lamp

-  IP-55 | 120V-60Hz
-  
-  2 x 20 W E26 TRIPLE CFL
-  2 x 10 W E26 A19 LED
- Dry + wet location

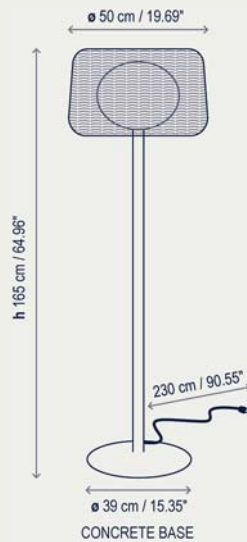

Sets

3130301U Natural White - Beige Concrete Base
P-695 Light Beige

3130303U Brown Graphite - Grey Graphite Concrete Base
P-696 Brown

Lampshade 19.69" x 11.81" - Synthetic Polyethylene Fiber
(Operating temperature: -70°C to +70°C) Shade structure made in aluminium.

Light source is protected by polyethylene globe of medium density and UV protection (Operating temperature: -40°C to +70°C).

Black wire without switch

Family

påg 18 18 24 24 30 30



All Bover's synthetic fiber collection are recyclable and non-toxic for environmental sustainability.

Finishing

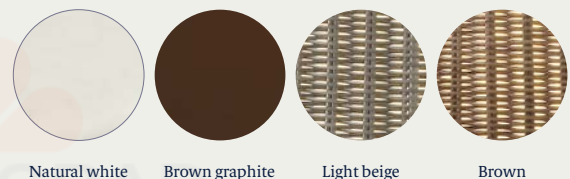

Natural white

Brown graphite

Light beige

Brown

Fora

by Alex Fernández Camps / Gonzalo Milà | 2010



FORA is a product designed to illuminate warm outdoor spaces. The floor version is distinguished by a concrete base. Light source is protected by an elliptical medium intensity and U.V. protection polythene globe, which guarantees a water tight electrical fixture. The shade is made of synthetic marrow, making it highly resistant to weathering while casting a pleasant, diffuse light.

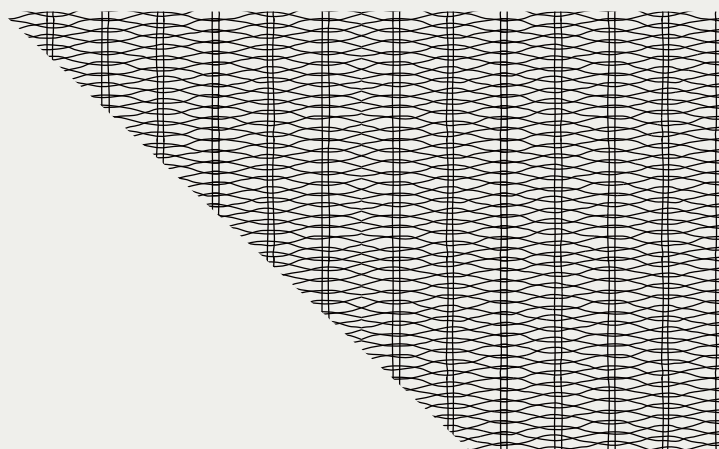

Hotel Nord 1901 / Girona

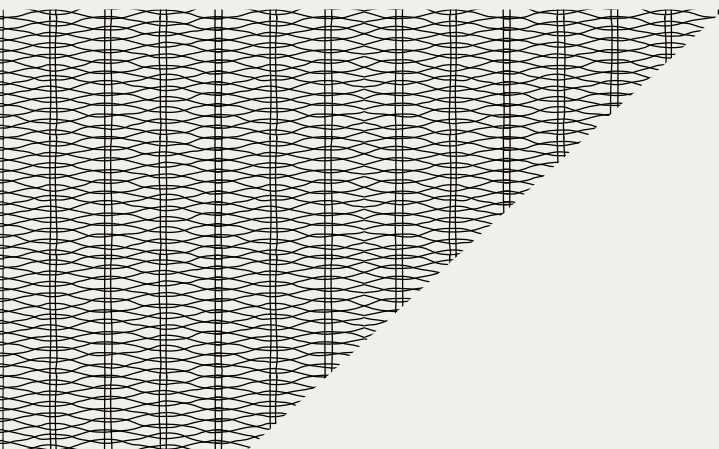

The result is a luminaire that adapts well to all types of indoor and outdoor environments. Its versatility is remarkable and difficult to find in products of this category. This family consists of a table lamp, floor lamp, ceiling, wall, pendant in small and big format.





Hostal Empúries / L'Escala



Alex Fernández Camps



Gonzalo Milà

**Delta'11
Awards**
△
Selection









Outdoor

Fora - S

Outdoor Pendant Lamp

	IP-55	120V~60Hz
		
	2 x 20 W E26 TRIPLE CFL	
	2 x 10 W E26 A19 LED	
Dry + wet location		

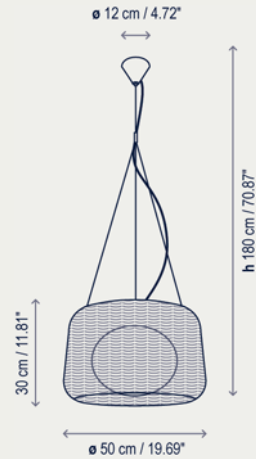

Sets



4130301U	Natural White
P-695C	Light Beige
4130303U	Brown Graphite
P-696C	Brown

Lampshade 19.69" x 11.81" - Synthetic Polyethylene Fiber (Operating temperature: -70°C to +70°C) Shade structure made in aluminium.

Light source is protected by polyethylene globe of medium density and UV protection (Operating temperature: -40°C to +70°C).

Fora - 90

Outdoor Pendant Lamp

	IP-55	120V~60Hz
		
	2 x 29 W E26 TRIPLE CFL	
	2 x 10 W E26 A19 LED	
Dry + wet location		

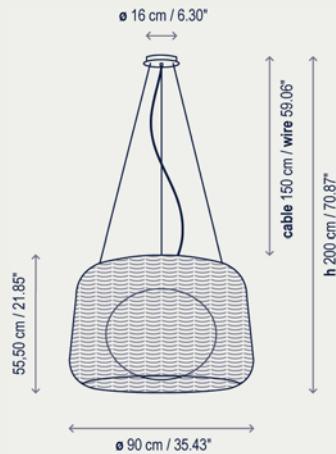

Sets

4030301U	Natural White
P-707C	Light Beige
4030303U	Brown Graphite
P-708C	Brown

Lampshade 35.43" x 21.85" - Synthetic Polyethylene Fiber (Operating temperature: -70°C to +70°C) Shade structure made in aluminium.

Light source is protected by polyethylene globe of medium density and UV protection (Operating temperature: -40°C to +70°C).

Wire 1,5 m / 59,0551 in



All Bover's synthetic fiber collection are recyclable and non-toxic for environmental sustainability.

Family

pàg 18 18 24 24 30 30



Finishing

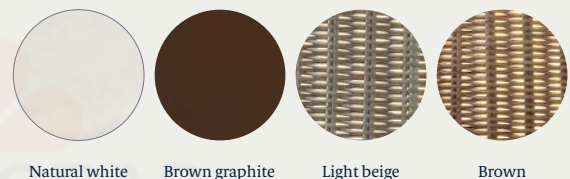





Slade Architecture / New York







Outdoor

Fora - A

Outdoor Wall Lamp

	IP-55	120V~60Hz
		
	2 x 20 W E26 TRIPLE CFL	
	2 x 10 W E26 A19 LED	
Dry + wet location		

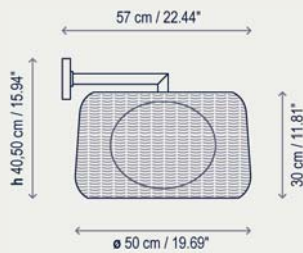

Sets

1130301U	Natural White
P-695C	Light Beige
1130303U	Brown Graphite
P-696C	Brown

Lampshade 19.69" x 11.81" - Synthetic Polyethylene Fiber (Operating temperature: -70°C to +70°C). Shade structure made in aluminium.

Light source is protected by polyethylene globe of medium density and UV protection (Operating temperature: -40°C to +70°C).

Fora - PF

Outdoor Ceiling Lamp

	IP-55	120V~60Hz
		
	2 x 20 W E26 TRIPLE CFL	
	2 x 10 W E26 A19 LED	
Dry + wet location		

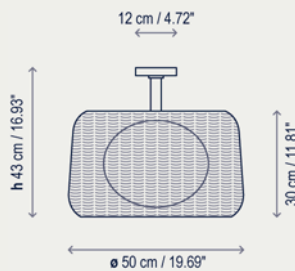

Sets

5130301U	Natural White
P-695C	Light Beige
5130303U	Brown Graphite
P-696C	Brown

Lampshade 19.69" x 11.81" - Synthetic Polyethylene Fiber (Operating temperature: -70°C to +70°C). Shade structure made in aluminium.

Light source is protected by polyethylene globe of medium density and UV protection (Operating temperature: -40°C to +70°C).

Family

påg 18 18 24 24 30 30



All Bover's synthetic fiber collection are recyclable and non-toxic for environmental sustainability.

Finishing

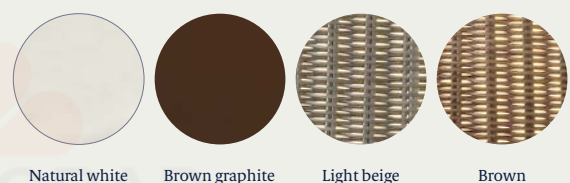

Natural white

Brown graphite

Light beige

Brown







Outdoor

Garota - PF 01

Outdoor Ceiling Lamp

IP-55 | 120V-60Hz

Dry + wet location

1 x 9 W LED | Led 9 W
Lumens 960 lm · CRI 90
Degrees Kelvin 2700°

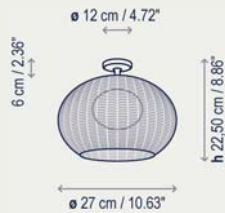

3350110201U Natural White
3350110203U Brown Graphite

P-803 Ivory White
P-804 Brown

Aluminium shade structure and canopy

Garota - PF 02

Outdoor Ceiling Lamp

IP-55 | 120V-60Hz

Dry + wet location

2 x 20 W E26 TRIPLE CFL

2 x 10 W E26 A19 LED

Dry + wet location

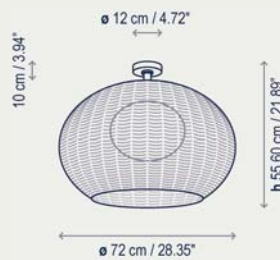

3350210001U Natural White
3350210003U Brown Graphite

P-801 Ivory White
P-802 Brown

Aluminium shade structure and canopy

Garota - A 01

Outdoor Wall Lamp

IP-55 | 120V-60Hz

Dry + wet location

1 x 9 W LED | Led 9 W
Lumens 960 lm · CRI 90
Degrees Kelvin 2700°

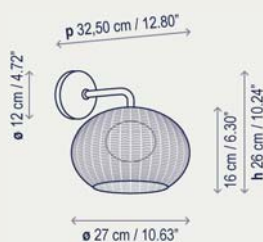

3350730201U Natural White
3350730203U Brown Graphite

P-803 Ivory White
P-804 Brown

Aluminium shade structure and canopy

All Bover's synthetic fiber collection are recyclable and non-toxic for environmental sustainability.

Family

pág 34 34 34 38 38 38 42 42 42 74 124 168 172

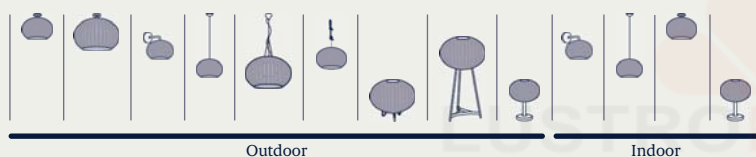

Finishing

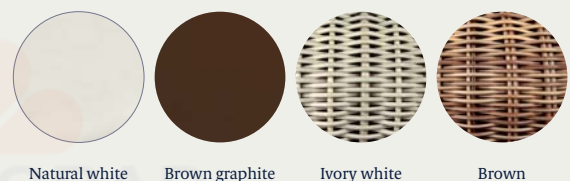

Garota

by Alex Fernández Camps / Gonzalo Milà | 2015



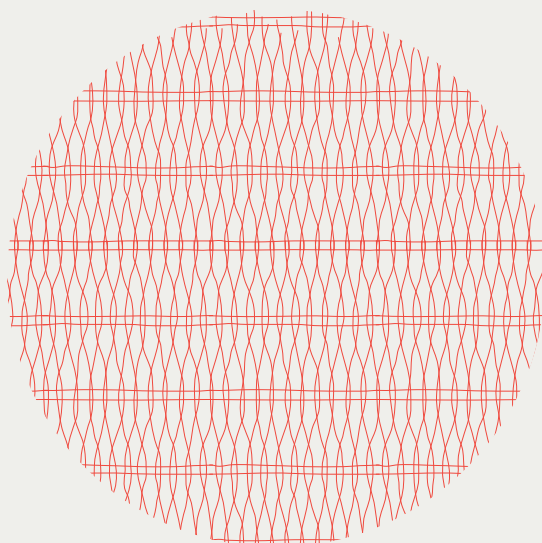

GAROTA is a tribute to the Sea urchins, commonly found in the Mediterranean coasts. We all have sometime held the naked shell of a sea urchin and admire its outlined body. The elliptical shapes made in polyethylene are an essential part of the Bover outdoor collections because they protect the light source from rain and humidity. These globes are the focus of the Bover outdoor products because they offer a warm and clear light, surrounded by organic, rounded and delicate shapes, designed to be equally installed indoors or outdoors and create a surrounding comfort.



Outdoor

Garota - S 01

Outdoor Pendant Lamp

IP-55 | 120V~60Hz

Dry + wet location

1 x 9 W LED | Led 9 W
Lumens 960 lm · CRI 90
Degrees Kelvin 2700^º

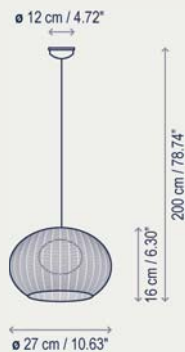

3350120101U Natural White
3350120103U Brown Graphite

P-803 Ivory White
P-804 Brown

Aluminium shade structure and canopy

Garota - S 02

Outdoor Pendant Lamp

IP-55 | 120V~60Hz

Dry + wet location

2 x 20 W E26 TRIPLE CFL

2 x 10 W E26 A19 LED

Dry + wet location

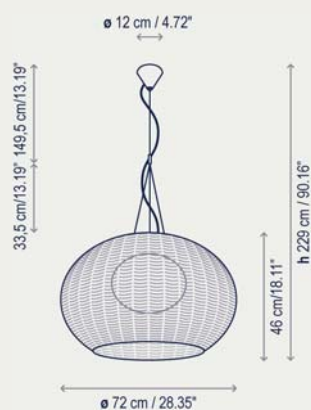

3350220201U Natural White
3350220203U Brown Graphite

P-801 Ivory White
P-802 Brown

Aluminium shade structure and canopy

Garota - Hang

Outdoor Pendant Lamp

IP-55 | 120V~60Hz

Dry + wet location

1 x 9 W LED | Led 9 W
Lumens 960 lm · CRI 90
Degrees Kelvin 2700^º



3350720101U Natural White
3350720103U Brown Graphite

P-803 Ivory White
P-804 Brown

This luminaire does not include a switch. The driver is installed on the wire.
Total wire length: 157.48 inches.
Aluminium shade frame - stainless steel hook.

Family

pág 34 34 34 38 38 38 42 42 42 74 124 168 172

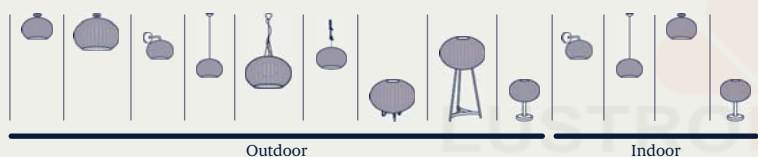

All Bover's synthetic fiber collection are recyclable and non-toxic for environmental sustainability.

Finishing

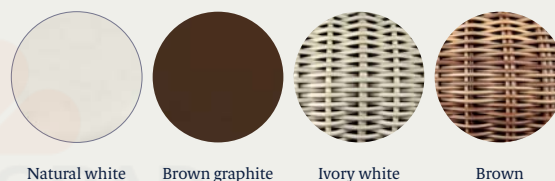

Natural white

Brown graphite

Ivory white

Brown





The Garota Hang is a lamp designed for terraces and gardens where typically there is not the ability for conventional outdoor lighting. You can hang from a tree or an arbor with the provided accessory allowing the ability to tie the lamp temporarily. The Hang accessory is rubber with an inner wire enabling excellent fastening while maintaining its form despite the inclement weather. It is resistant to UV rays and allows a long sun exposure.

Use caution so as not to scratch or mark surfaces when fastening.

The Garota Hang has 4 meters of neoprene cable with plug.

With this same shade size there is a hard wired version with ceiling rose and IP -55 neoprene cable.

In all cases the outdoor version of Garota incorporates a small elliptical polyethylene diffuser which allows us to maintain the airtight LED plate.





Outdoor

Garota - P 01

Outdoor Floor Lamp

IP-55 | 120V-60Hz



2 x 20 W E26 TRIPLE CFL

2 x 10 W E26 A19 LED

Dry + wet location



3350130088U Stainless Steel 316

P-801 Ivory White
P-802 Brown

Consult for floor fastening options.

Garota - P 02

Outdoor Floor Lamp

IP-55 | 120V-60Hz



2 x 20 W E26 TRIPLE CFL

2 x 10 W E26 A19 LED

Dry + wet location



3350230001U Natural White
3350230003U Brown Graphite

P-801 Ivory White
P-802 Brown

Stainless steel structure, cataphoresis treatment and outdoor paint.

Consult for floor fastening options.

Height non customizable.

Garota - Mini

Outdoor Mini Table Lamp

IP-55 | 120V-60Hz

Dry + wet location

1 x 9 W LED
Led 9 W
Lumens 960 lm · CRI 90
Degrees Kelvin 2700°



3350630201U Natural White
3350630203U Brown Graphite

P-803 Ivory White
P-804 Brown

Aluminium shade frame

Touch dimming switch: step dimming in three levels; turn on/off by long push.

Family

pag 34 34 34 38 38 38 42 42 42 74 124 168 172

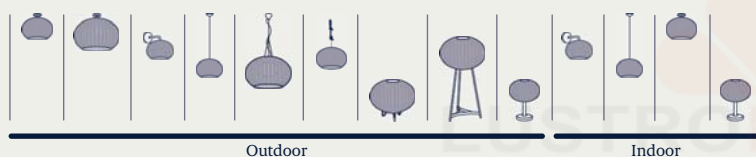

All Bover's synthetic fiber collection are recyclable and non-toxic for environmental sustainability.

Finishing

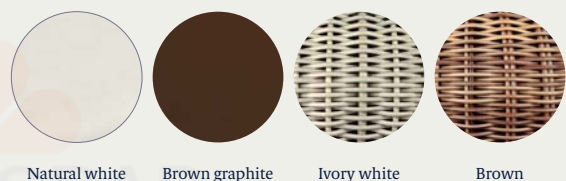

Natural white

Brown graphite

Ivory white

Brown





Hostal Empúries / L'Escala

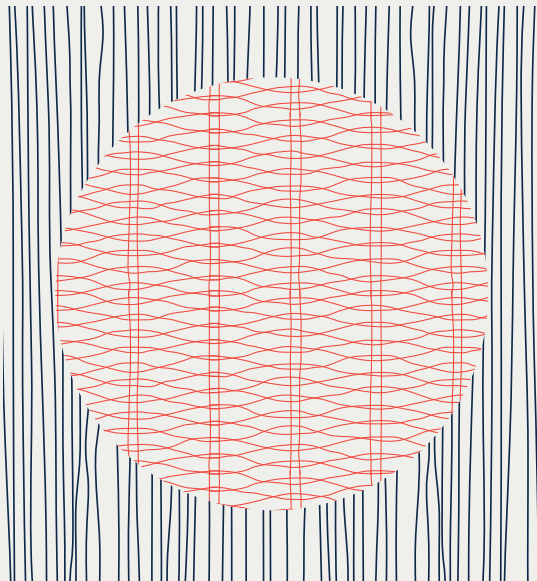

The Garotas are part of a diverse collection of outdoor lamps that create unique environments and contain a common concept; the shade in the form of a sea urchin.

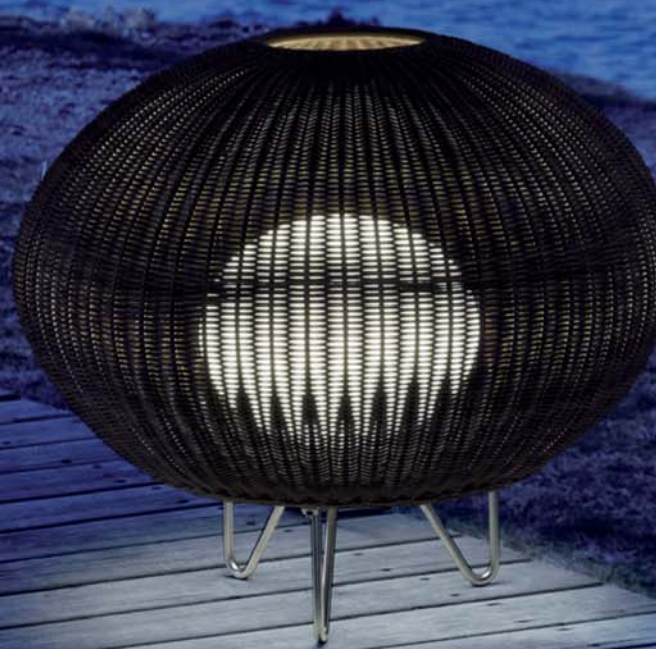



Outdoor

Maxi - P Outdoor Floor

	IP-55	120 - 277V 50 - 60Hz
2 x 54W Minibipin T5 L. FLUO		
Dry + wet location		

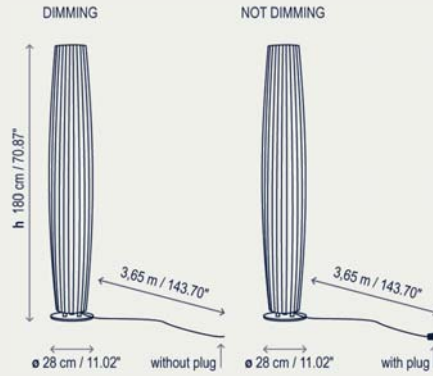

3229500U Electrical Bottom Inst. With Plug
D3229500U Electrical Bottom Inst.
Without Plug + Dim 0-10V

Black wire / without switch

BULBS INCLUDED fluorescent tubes already installed inside the luminaire.
Light source is protected by a Poliethylene shade (operating temperature: -40°C to +70°C)

Fixing on the floor:
The floor lamp can be fixed by removing the rubber stoppers placed on the foot base.

Fixing on the surface with built-in wire:
In this case, wire should be made out of rubber type HO5RN or superior, with a diameter between 0,236" and 0,315".

Maxi - S Outdoor Pendant Lamp

	IP-55	120 - 277V 50 - 60Hz
2 x 54W Minibipin T5 L. FLUO		
Dry + wet location		

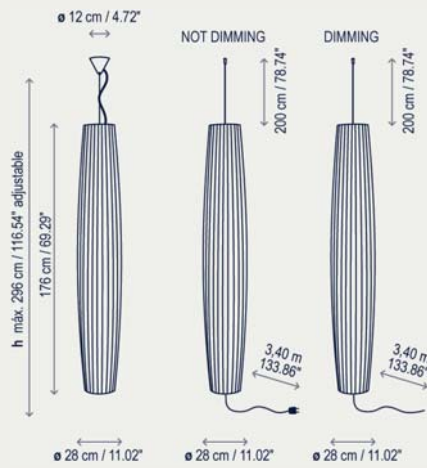

4429500TOPU Electrical Upper Installation
4429500INFU Electrical Bottom Installation
D4429500TOPU Electrical Upper Installation Dim 0-10V
D4429500INFU Electrical Bottom Installation Dim 0-10V

Fluorescent tubes already installed inside the luminaire.
Light source is protected by a Poliethylene shade (operating temperature: -40°C to +70°C)
Adjustable tensor wire

White canopy finished (only for upper installation)
Black wire / without switch

Family

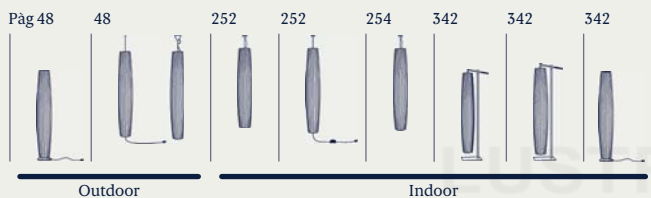

Finishing

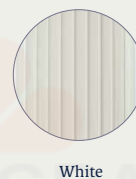

Maxi

by Joana Bover | 2004



Hotel Vincci / Marítimo

MAXI represents for sure the most characteristic and emblematic product of BOVER. Made out of translucent ribbon since its creation in 2001, Maxi has achieved positioning itself as one of the most reliable and best seller product in BOVER's catalogue, regardless the market or culture it is addressed to. Maxi meets in one product BOVER's essence: its smooth shapes, its warm light and the different available options. It presents to the market a non-temporal offering, adapting itself without fussiness to any environment without losing its contemporary aspect. Motivated by these reasons, we decided to go a step forward and reinvent it going beyond the verge of indoor products, to bring Maxi to gardens, terraces and open spaces where its marked warm feature can offer us a good light coming out from its polythene shade.

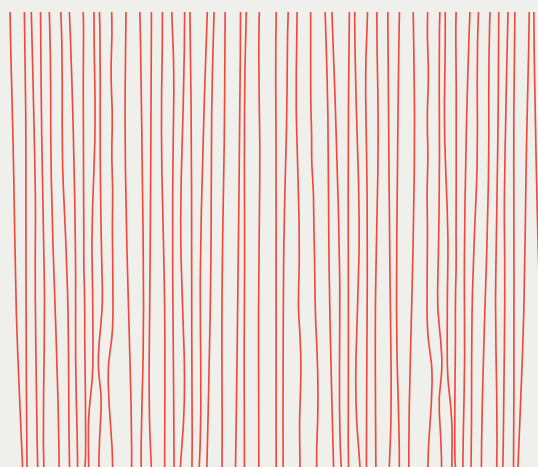



Outdoor

Syra - 60 Outdoor

Outdoor Pendant Lamp

IP-55 | 120 - 277V
50 - 60Hz

Dry + wet location

22 W LED | Led: 66 x 0.33 W = 22 W
Lumens: 2500 lm · CRI: 90
Degrees Kelvin: 2700^º

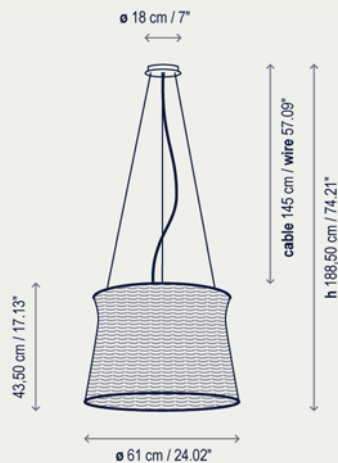

2640220158U White
2640220159U Chocolate Brown
2640220458U Dimming 0-10V / White
2640220459U Dimming 0-10V / Chocolate Brown

Syra - 90 Outdoor

Outdoor Pendant Lamp

Big Format

IP-55 | 120 - 277V
50 - 60Hz

Dry + wet location

28 W LED | Led: 84 x 0.33 W = 28 W
Lumens: 3200 lm · CRI: 90
Degrees Kelvin: 2700^º

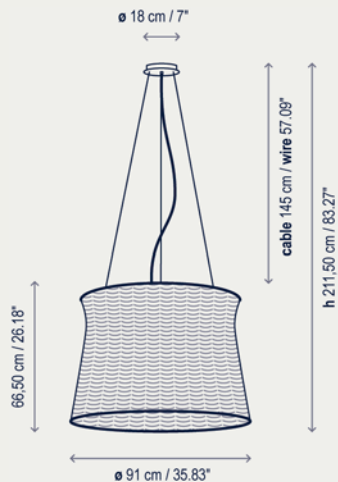

2640320158U White
2640320159U Chocolate Brown
2640320458U Dimming 0-10V / White
2640320459U Dimming 0-10V / Chocolate Brown

Family

pàg 52 52



Syra - 60 / 90
Outdoor

150

Syra - 45
Only Indoor
Application



Finishing

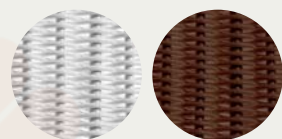

White

Chocolate brown

Syra

by Alex Fernández Camps / Gonzalo Milà | 2014



Tarambana Espai Cultural i Gastronòmic / Cardedeu



SYRA is an outdoor pendant lamp, easily identifiable and characteristic within BOVER's Outdoor collection. Shade is made of aluminum structure, woven with synthetic fiber. The inner light source is protected by an opal glass diffuser which softens the outgoing light. Metal elements subject to welding are treated with antirust processes (Cathaphoresis) Designed to be a versatile product to be used both in interior and outdoor applications. Thanks to the LED plate, Syra is a resistant and energysaving luminaire. Syra range is ideal for half-closed spaces, terraces and covered porches which need warm light and kind elements to bring comfort. Its height can be regulated through the tensor wires.







Contemporary

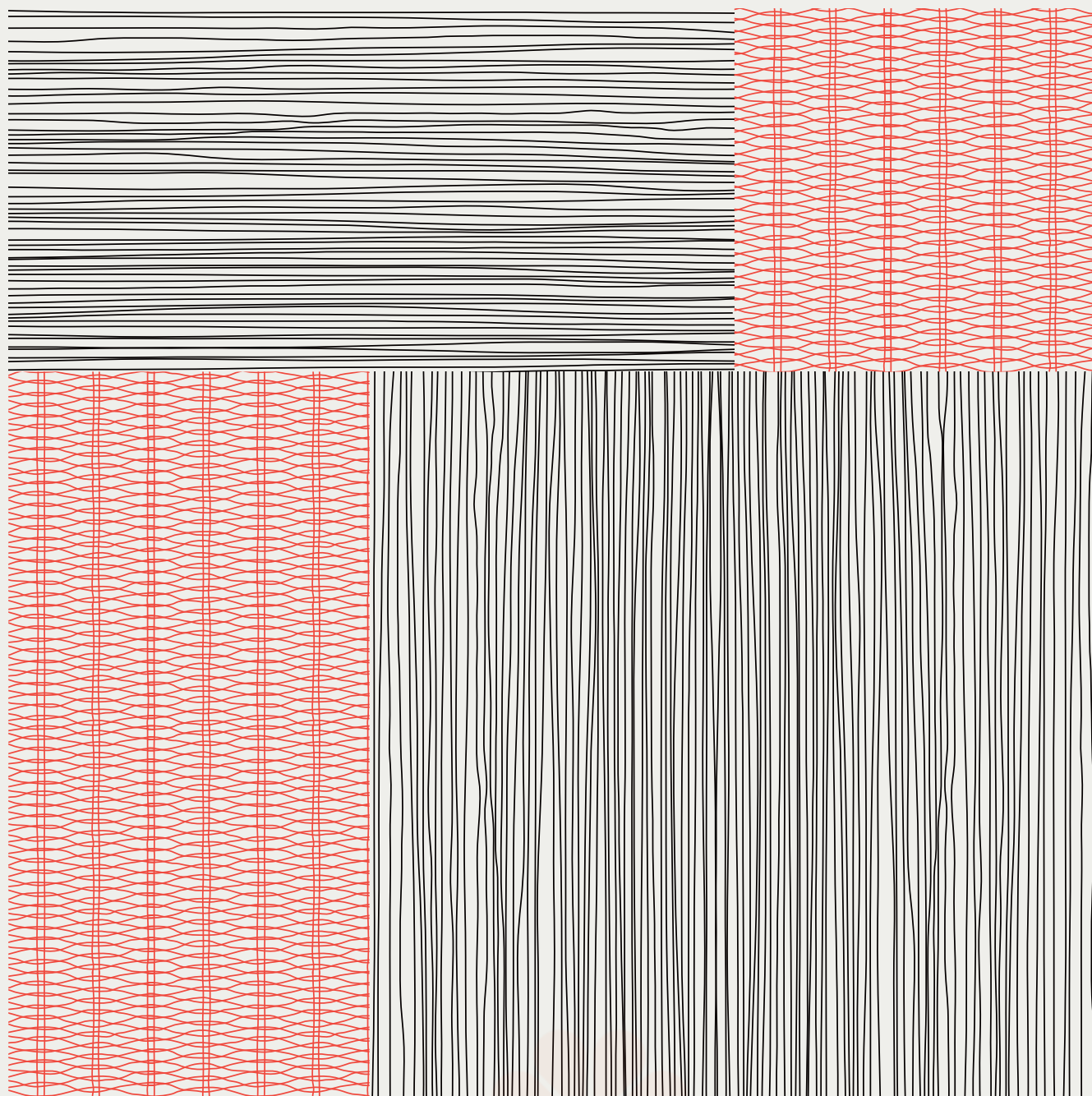

Contemporary / Wall Lamp

Alba - 60

IP-20 ADA 120 - 277V
50 - 60Hz



1 x 24W Minibipin T5 L. FLUO

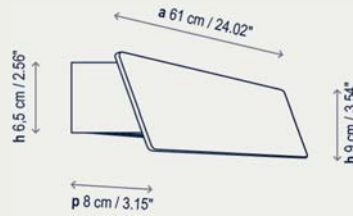

2270100263U White - Oak Wood
2270100264U Polished Aluminum
2270100265U White

2270100463U* Dim 0-10V / White - Oak Wood
2270100464U* Dim 0-10V / Polished Aluminum
2270100465U* Dim 0-10V / White

* Dimming Ballast (Dim 0-10V)

IP-20 ADA 120V~60Hz



11,5 W LED Led: 28 x 0,41 W = 11,5 W
Lumens: 1060 lm · CRI: 90
Degrees Kelvin: 2700°

2270100663U Led / White - Oak Wood
2270100664U Led / Polished Aluminum
2270100665U Led / White

Important note: Must mount on 2" x 4" rectangular junction box.

Optional (Consult)
Available switch option.

Alba - 90

IP-20 ADA 120 - 277V
50 - 60Hz



1 x 39W Minibipin T5 L. FLUO

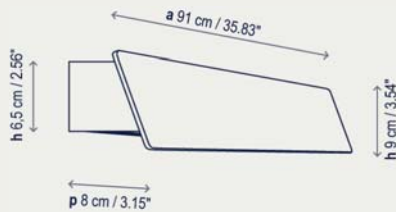

2270200263U White - Oak Wood
2270200264U Polished Aluminum
2270200265U White

2270200463U* Dim 0-10V / White - Oak Wood
2270200464U* Dim 0-10V / Polished Aluminum
2270200465U* Dim 0-10V / White

* Dimming Ballast (Dim 0-10V)

IP-20 ADA 120V~60Hz



17 W LED Led: 42 x 0,41 W = 17 W
Lumens: 1600 lm · CRI: 90
Degrees Kelvin: 2700°

2270200663U Led / White - Oak Wood
2270200664U Led / Polished Aluminum
2270200665U Led / White

Important note: Must mount on 2" x 4" rectangular junction box.

Optional (Consult)
Available switch option.



Finishing

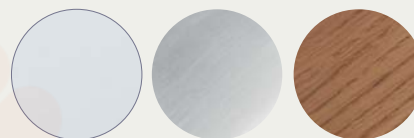

White Polished aluminum Oak wood

Alba

by Rubén Saldaña | 2014

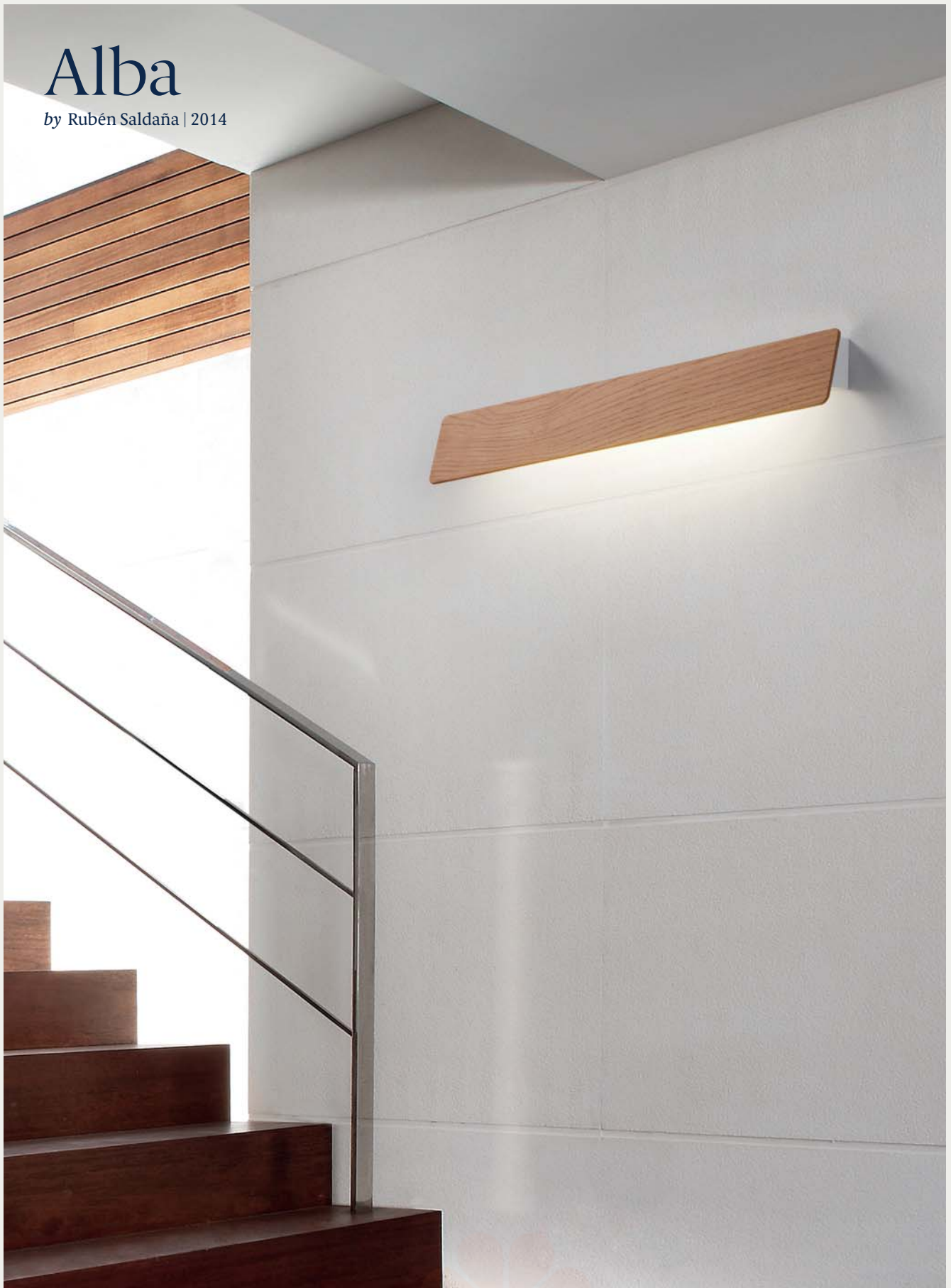





ALBA is an architectural design wall sconce with frontal structure made of aluminum or wood. It is especially suitable to project light over elements requiring direct and uniform light. Includes polycarbonate opal bottom diffuser. This wall lamp is available in three finishings. Optional on-off switch located on the upper part of the luminaire.



Contemporary / Wall Lamp

BCN

 IP-20 | 120 - 277V | 50 - 60Hz

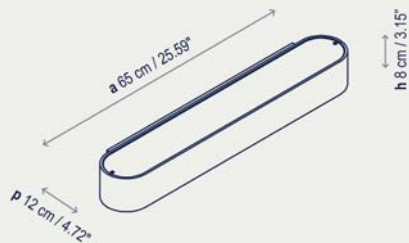
 2 x 24W Minibipin T5 L. FLUO



- 1526501U White Brilliant Lacquer
- 1526523U Black Brilliant Lacquer
- 1526522U Red Brilliant Lacquer

- D1526501U* Dim 0-10V / White Brilliant Lacquer
- D1526523U* Dim 0-10V / Black Brilliant Lacquer
- D1526522U* Dim 0-10V / Red Brilliant Lacquer

* Dimming Ballast (Dim 0-10V)

Finishing: Polyurethane/brilliant lacquer finish

Important note: Must mount on 2" x 4" rectangular junction box.

pàg 64 | 198 | 198



Finishing

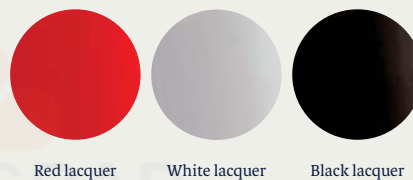

BCN

by Joana Bover | 2012





Its enfolding outline, dimensions and brilliant lackered finishings distinguishes this wall lamp, defining it as a clear example of contemporary design. Its short protruding measures from the wall (12 cms) give as a result a product especially projected to light corridors, mirrors o areas requiring a clear, direct and uniform light.

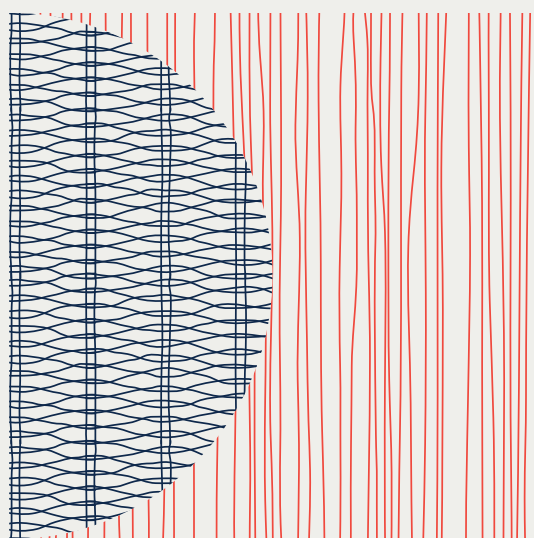



Contemporary / Wall Lamp

Club - A

-  120V-60Hz 
-  1 x 60 W E26 A15 INC
-  1 x 5 W E26 A15 LED
-  1 x 13 W E26 T2 CFL

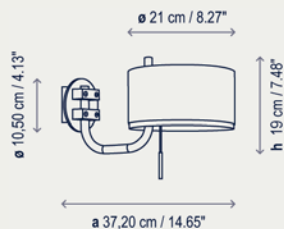

1532812U Matte Black-Nickel

Black aluminum shade
White PVC interior B1 Flame Resistant
Included aluminum top diffuser

No swivel arm
Pull string switch
Surface back box 4.3"

Important note: Wall sconce product photography doesn't show US backplate mounting.

Club - A 2L

-  120V-60Hz 
-  2 x 60 W E26 A15 INC
-  2 x 5 W E26 A15 LED
-  2 x 13 W E26 T2 CFL

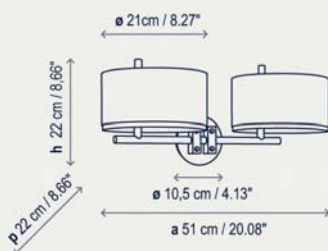

1232812U Matte Black-Nickel

Black aluminum shade
White PVC interior B1 Flame Resistant
Included aluminum top diffuser
Surface back box 4.3"

Important note: Wall sconce product photography doesn't show US backplate mounting.



Family

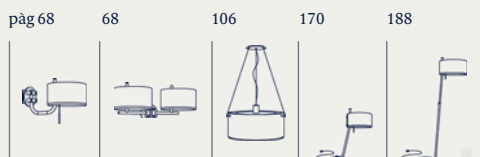

Finishing



Club

by Luis Viñas | 2012



Contemporary / Wall Lamp

Flexo

120V-60Hz



1 x 1,2 W LED

Led: 1,2 W · Optics: 45°
Lumens: 85 lm · CRI: 90
Degrees Kelvin: 2900°

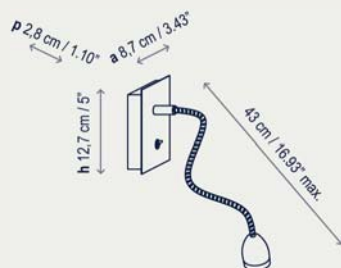

- FL25106U Chrome
- FL25105U Satin Nickel
- FL25160U Nickel Dark Leather
- FL25161U Nickel Caramel Leather
- FL25117U Black Glass Chrome

Flexo made in brass to ensure greater flexibility and rigidity. Aluminium hood and switch on back plate. Surface back box 4.25" x 2.64"

Important note:
Wall sconce product photography doesn't show US backplate mounting.
Must mount vertically on 2" x 4" rectangular junction box.



Finishing

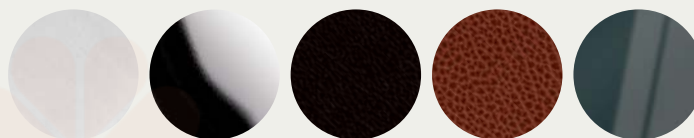

Satin nickel

Brilliant chrome

Dark leather

Caramel leather

Black glass

Flexo

by Joana Bover | 2006



Contemporary / Wall Lamp

Flexo Lexa

120V-60Hz



1 x 1,2 W LED

Led: 1,2 W · Optics: 45°
Lumens: 85 lm · CRI: 90
Degrees Kelvin: 2900^º

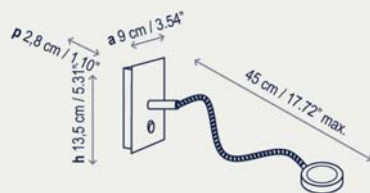

FL20505U Satin Nickel
FL20506U Brilliant Chrome

Flexo made in brass to ensure greater flexibility and rigidity, with Zamac injection. Hood and switch on back plate. Surface back box 4.2" x 2.63"

Important note:
Must mount vertically on 2" x 4" rectangular junction box.



Finishing

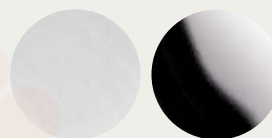

Satin nickel

Brilliant chrome

Flexo Lexa

by Christophe Mathieu | 2008



Contemporary / Wall Lamp

Garota - A / 01 Indoor

Wall Lamp

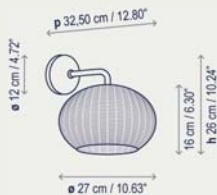

3350100001U Natural White
3350100003U Brown Graphite

P-803 Ivory White
P-804 Brown

Aluminium shade structure and canopy

Important note: Must mount on 4" x 4" junction box.

Family

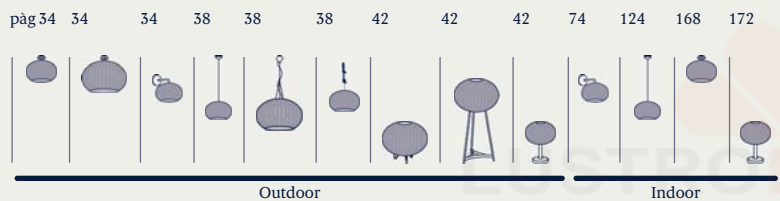

All Bover's synthetic fiber collection are recyclable and non-toxic for environmental sustainability.

Finishing

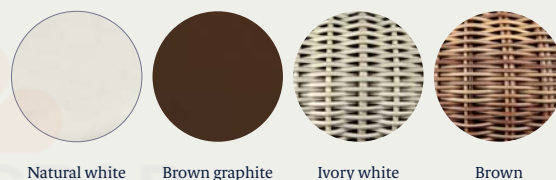

Natural white

Brown graphite

Ivory white

Brown

Garota Indoor

by Alex Fernández Camps / Gonzalo Milà | 2015



Contemporary / Wall Lamp

Lea - 01



1 x 24 W Minibipin T5 L. FLUO

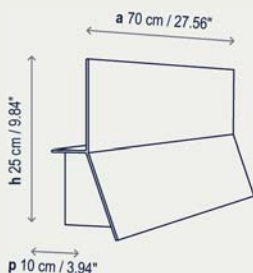

0121501U White
D0121501U* Dim 0-10V / White

* Dimming Ballast (Dim 0-10V)

Polycarbonate diffuser included
Upper shelf holds up to 8.82 lbs

Special colors: RAL number to be indicated. Minimum quantity: 5 pieces.

Lea - 02



1 x 39 W Minibipin T5 L. FLUO

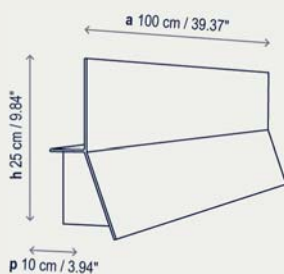

0221501U White
D0221501U* Dim 0-10V / White

* Dimming Ballast (Dim 0-10V)

Polycarbonate diffuser included
Upper shelf holds up to 8.82 lbs

Special colors: RAL number to be indicated. Minimum quantity: 5 pieces.

Lea - 03



1 x 54 W Minibipin T5 L. FLUO

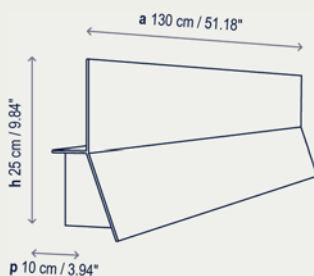

0321501U White
D0321501U* Dim 0-10V / White

* Dimming Ballast (Dim 0-10V)

Polycarbonate diffuser included
Upper shelf holds up to 8.82 lbs

Special colors: RAL number to be indicated. Minimum quantity: 5 pieces.



Optional switch / Consult

Finishing



Lea white

Lea

by Alex Fernández Camps | 2009



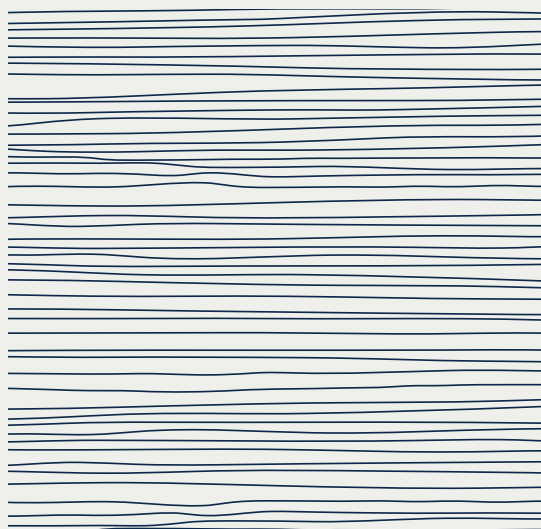

Lea is an architectural wall light with no ornaments. It is useful to keep our work space in order and also offers a high quality bottom light. Lea can be installed in different places, such as headboard, corridors, kitchens...although above a desk would be the place where it probably looks best. When we are staying in a hotel room we can find lots of information about the city, international press, info about the hotel usually on the room desk. The Lea wall lights include a shelf in the top part able to store books and magazines up to 4 kgs to release space from the desk. They are also available with direct switch.



Contemporary / Wall Lamp

Liban

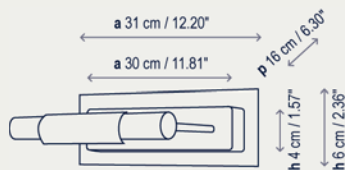

- 1118605U Satin Nickel
- 1118606U Brilliant Chrome
- 1118605GU Satin Nickel / G24q1
- 1118606GU Brilliant Chrome / G24q1

Important note:
Wall sconce product photography doesn't show US backplate mounting.
Must mount horizontally on 2" x 4" rectangular junction box.

Finishing



Satin nickel

Brilliant chrome

Liban

by Lluís Porqueras / Cristian Diez | 2003



Contemporary / Wall Lamp

Nón Lá - A 01

 ADA | 120 - 277V | 50 - 60Hz



 10,5 W LED | Led 35 x 0,3 W = 10,5 W
Lumens 1200 lm · CRI 90
Degrees Kelvin 2700°

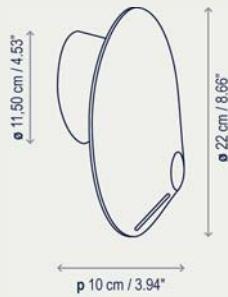

3320101101U Dim 0-10V White Brilliant Lacquer
 3320101106U Dim 0-10V Chrome
 3320101123U Dim 0-10V Black Brilliant Lacquer
 3320101190U Dim 0-10V Brilliant Copper

Nón Lá - A 02

 120 - 277V | 50 - 60Hz



 10,5 W LED | Led 35 x 0,3 W = 10,5 W
Lumens 1200 lm · CRI 90
Degrees Kelvin 2700°

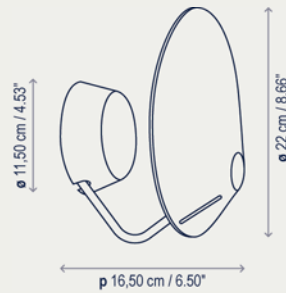

3320201101U Dim 0-10V White Brilliant Lacquer
 3320201106U Dim 0-10V Chrome
 3320201123U Dim 0-10V Black Brilliant Lacquer
 3320201190U Dim 0-10V Brilliant Copper

Nón Lá - A 03

 120 - 277V | 50 - 60Hz



 10,5 W LED | Led 35 x 0,3 W = 10,5 W
Lumens 1200 lm · CRI 90
Degrees Kelvin 2700°



3320301101U Dim 0-10V White Brilliant Lacquer
 3320301106U Dim 0-10V Chrome
 3320301123U Dim 0-10V Black Brilliant Lacquer
 3320301190U Dim 0-10V Brilliant Copper

Nón Lá - A 04

 120 - 277V | 50 - 60Hz



 10,5 W LED | Led 35 x 0,3 W = 10,5 W
Lumens 1200 lm · CRI 90
Degrees Kelvin 2700°



3320401101U Dim 0-10V White Brilliant Lacquer
 3320401106U Dim 0-10V Chrome
 3320401123U Dim 0-10V Black Brilliant Lacquer
 3320401190U Dim 0-10V Brilliant Copper

Family

pàg 82 82 82 82 134 138 138 138 178

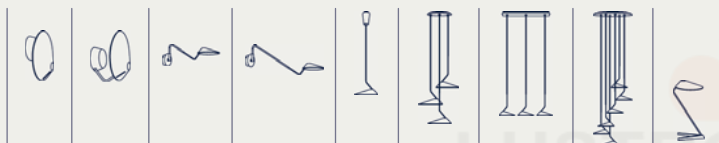

Finishing

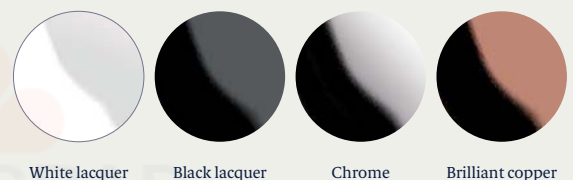

White lacquer

Black lacquer

Chrome

Brilliant copper

Nón Lá

by Jorge Pensi Design Studio | 2015





One of the most distinctive signs from Vietnam is the hat used by women in the countryside to protect themselves from the sun and the rain and as a basket to carry food. NÓN LÁ is the name used to describe this Vietnamese hat and it is also the name we selected for this lamp. This is the way we pay homage to its shape and centenary culture. The simplicity of this cone-shaped lamp, offers a lightweight and resistant structure with an avant-garde touch thanks to the decentralized light cavity. The lamp's hood is made out of aluminium and then plated or lacquered. Nón Lá fills the space with direct light and includes a polycarbonate diffuser which hosts a dimming led plate.







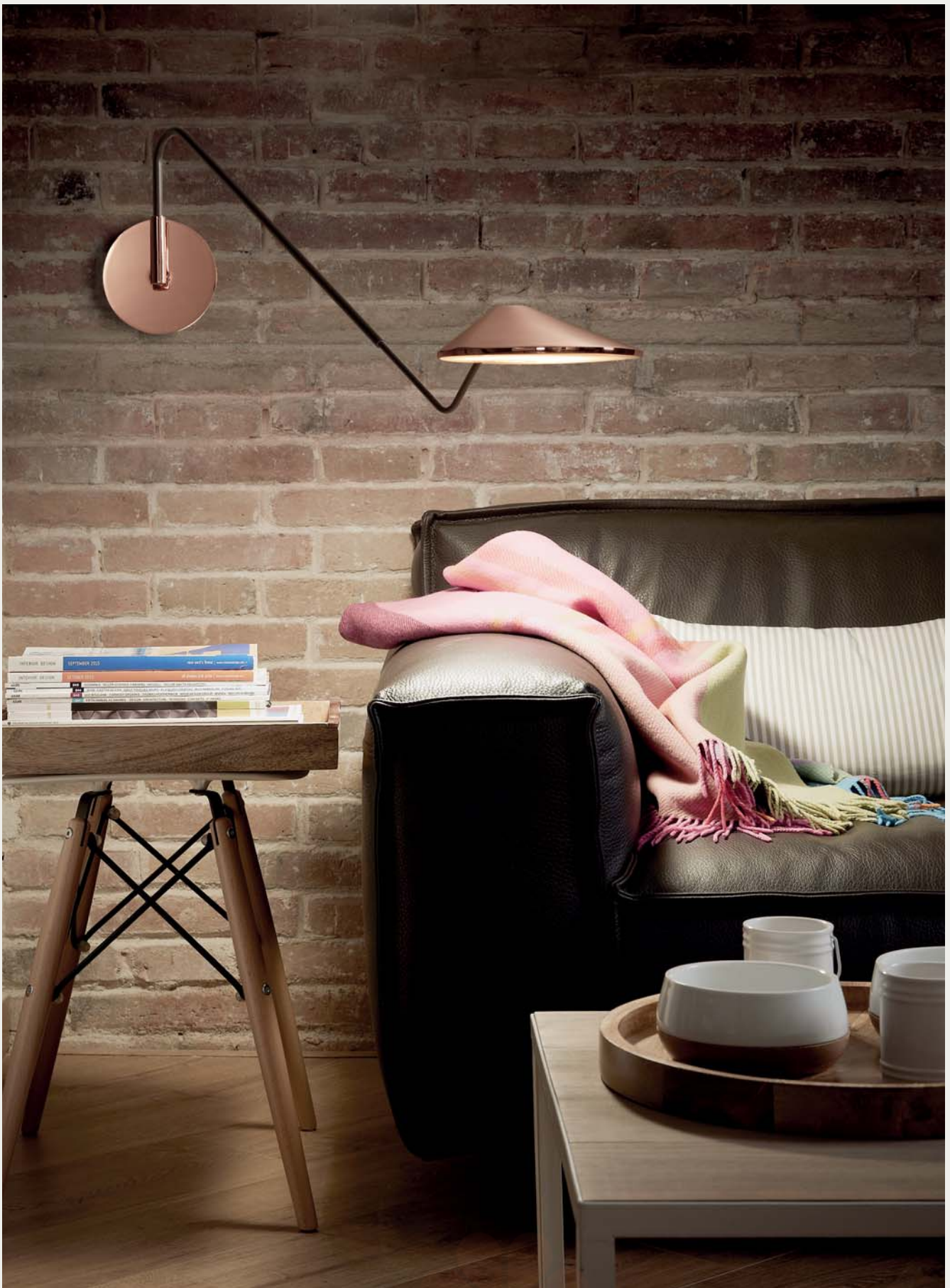

Contemporary / Wall Lamp

Plana - T5

120 - 277V
50 - 60Hz



2 x 24W Minibipin T5 L. FLUO

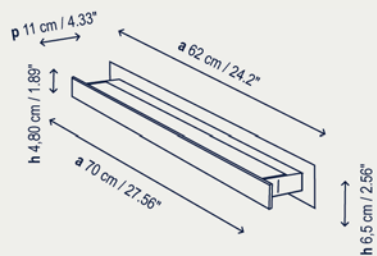

T519805U	Satin Nickel
T519806U	Brilliant Chrome
DT519805U*	Dim 0-10V / Satin Nickel
DT519806U*	Dim 0-10V / Brilliant Chrome

* Dimming Ballast (Dim 0-10V)

Important note:
Wall sconce product photography doesn't show US backplate mounting.
Must mount on 2" x 4" rectangular junction box.

Finishing



Satin nickel

Brilliant chrome

Plana T5

by Christophe Mathieu | 2004



Contemporary / Wall Lamp

Spock - A

120V-60Hz

4.8 W LED
Led: 4 x 1.2 W = 4.8 W
Lumens: 85 x 4 = 340 lm
CRI: 90 · Degrees Kelvin: 2900^o

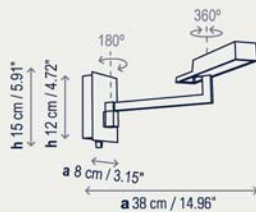

- 1110505LU Nickel
- 1110506LU Chrome
- 1110511LU Chrome-White

Surface back box 4.7" x 3.1"
 Important note: Must mount vertically 2" x 4"

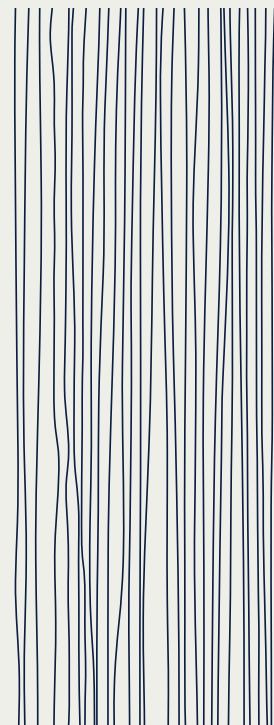

Family

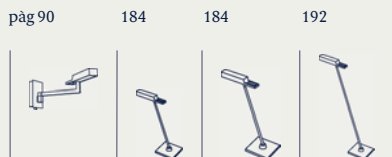

Finishing

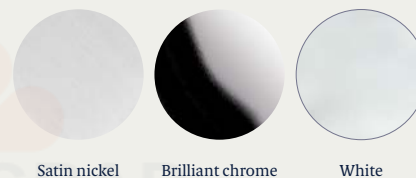



Spock

by Christophe Mathieu | 2007



Contemporary / Wall Lamp

Tria - 01

 ADA | 120 - 277V
50 - 60Hz | 

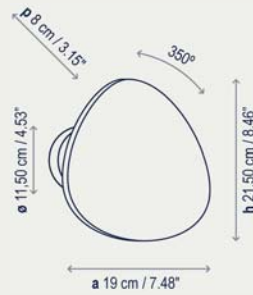

 8,7 W LED | Led 24 x 0,36 W = 8,7 W
Lumens 960 lm · CRI 90
Degrees Kelvin 2700°



2080100601U White Satin Lacquer
2080100635U Natural Oak

Front wall adjustable position
Wood material

Tria - 02

 ADA | 120 - 277V
50 - 60Hz | 

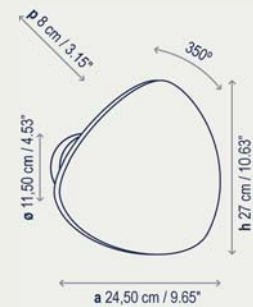

 13 W LED | Led 36 x 0,36 W = 13 W
Lumens 1440 lm · CRI 90
Degrees Kelvin 2700°



2080201101U Dim 0-10V White Satin Lacquer
2080201135U Dim 0-10V Natural Oak

Front wall adjustable position
Wood material

Tria - 03

 ADA | 120 - 277V
50 - 60Hz | 

 17 W LED | Led 48 x 0,36 W = 17 W
Lumens 1920 lm · CRI 90
Degrees Kelvin 2700°

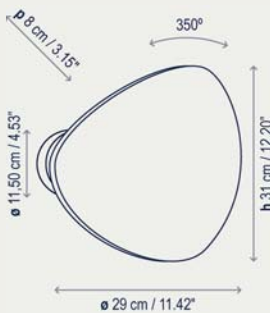

2080301101U Dim 0-10V White Satin Lacquer
2080301135U Dim 0-10V Natural Oak

Front wall adjustable position
Wood material

Tria - Set 3

 ADA | 120 - 277V
50 - 60Hz | 

 39 W LED | Led 108 x 0,36 W = 39 W
Lumens 4320 lm · CRI 90
Degrees Kelvin 2700°

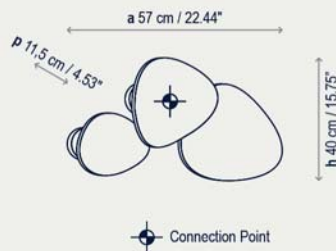

2081301101U Dim 0-10V White Satin Lacquer
2081301135U Dim 0-10V Natural Oak

Front wall adjustable position
Wood material
1 point connection

Finishing

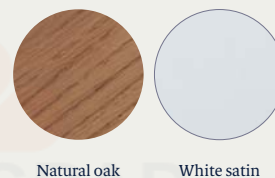

Tria

by Rubén Saldaña | 2015



Custom finish | Front wall adjustable position

Contemporary / Wall Lamp

Tria - Set 6



69 W LED

Led 192 x 0,36 W = 69 W
Lumens 7080 lm · CRI 90
Degrees Kelvin 2700°

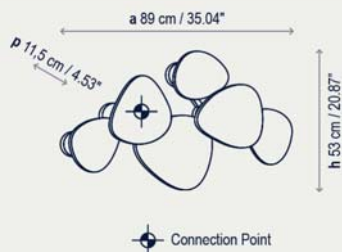

2081601101U Dim 0-10V White Satin Lacquer
2081601135U Dim 0-10V Natural Oak

Front wall adjustable position
Wood material
1 point connection

Tria - Set 8



103,4 W LED

Led 288 x 0,36 W = 103,4 W
Lumens 11520 lm · CRI 90
Degrees Kelvin 2700°

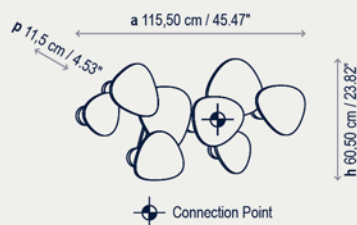

2081801101U Dim 0-10V White Satin Lacquer
2081801135U Dim 0-10V Natural Oak

Front wall adjustable position
Wood material
1 point connection

Finishing

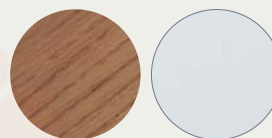

Natural oak

White satin



TRIA is a wall light designed as a modular system made with led plates, which makes it easy to build up light clusters connected to each other by an inside structure. The TRIA frontal parts are made in white lacquer or natural oak and they can be slightly moved to offer a suggestive play of light and shadow around the organic shape of the diffuser. TRIA can be installed either as a single wall light or as a light module with a sole connection point on the wall which makes it easier to be installed in halls, offices and hotel reception desks and lobbies. A dimmable version is available.









Contemporary / Wall Lamp

Twall - LED

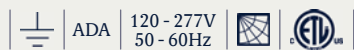

8.2 W LED

Led 24 x 0,34 W = 8.2 W
Lumens 840 lm · CRI 90
Degrees Kelvin 2700°

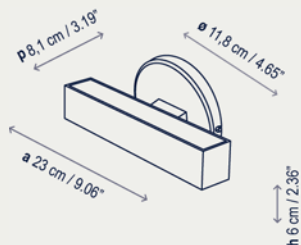

- 1970101105U Dim 0-10V / Satin Nickel
- 1970101106U Dim 0-10V / Brilliant Chrome
- 1970101165U Dim 0-10V / White

Important note: Must mount on 4" x 4" junction box.

Important note:
Wall sconce product photography doesn't show US
backplate mounting.

Finishing



Satin nickel

Brilliant chrome

White

Twall - LED

by Christophe Mathieu | 2004



Contemporary / Pendant Lamp

Cala - S

120V-60Hz



4 x 60 W E26 A15 INC

4 x 10 W E26 A19 LED

4 x 20 W E26 TRIPLE CFL

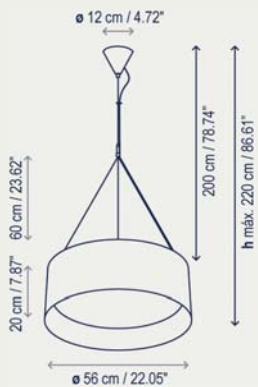

- 4132601U White Brilliant Lacquer
- 4132623U Black Brilliant Lacquer
- 4132622U Red Brilliant Lacquer

Finishing: Polyurethane/brilliant lacquer finish

Optical glass diffuser
Adjustable tensor wire

LED option available

Family

påg 102 160



Finishing

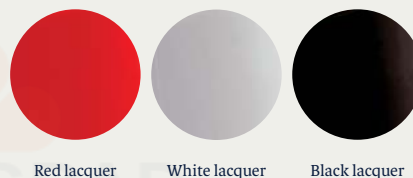

Cala

by Jordi Llopis | 2013







Contemporary / Pendant Lamp

Club - S

- 120V-60Hz 
- 3 x 60 W E26 A15 INC
- 3 x 5 W E26 A15 LED
- 3 x 15 W E26 T3 CFL

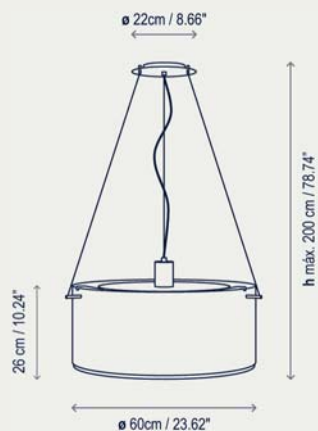

4132812U Matte Black-Nickel

Black aluminum shade
White PVC interior B1 Flame Resistant
Upper aluminum diffuser included
Bottom glass diffuser included



Family

påg 68 68 106 170 188

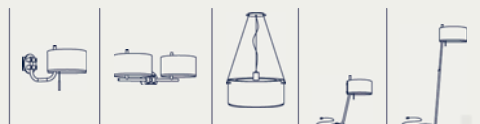

Finishing

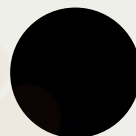

Matte black

Club

by Luis Viñas | 2012



Contemporary / Pendant Lamp

Dome - 60

120 - 277V
50 - 60Hz

10,2 W LED

Led: 10,2 W
Lumens: 1045 lm · CRI: 82
Degrees Kelvin: 2700^o

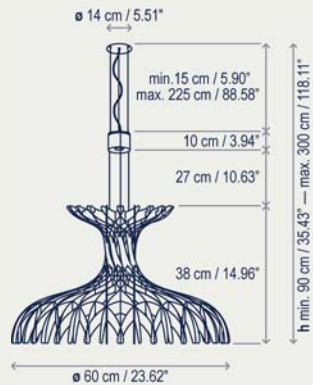

2580621000U DIM 0-10V Matte White
2580621012U DIM 0-10V Matte Black

Lampshade

P-829 Natural Wood Shade

Upon request Dome can be made with CRI 90 / 3000 degrees Kelvin

Dome - 90 Big Format

120 - 277V
50 - 60Hz

25 W LED

Led: 25 W
Lumens: 1500 lm · CRI: 82
Degrees Kelvin: 2700^o

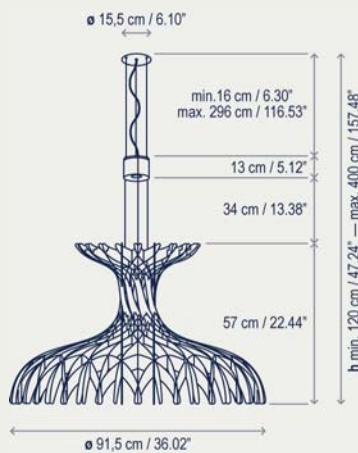

2580921000U DIM 0-10V Matte White
2580921012U DIM 0-10V Matte Black

Lampshade

P-811 Natural Wood Shade

Upon request Dome can be made with CRI 90 / 3000 degrees Kelvin

Dome - 180 Big Format

120 - 277V
50 - 60Hz

75 W LED

Led: 75 W
Lumens: 4500 lm · CRI: 82
Degrees Kelvin: 2700^o

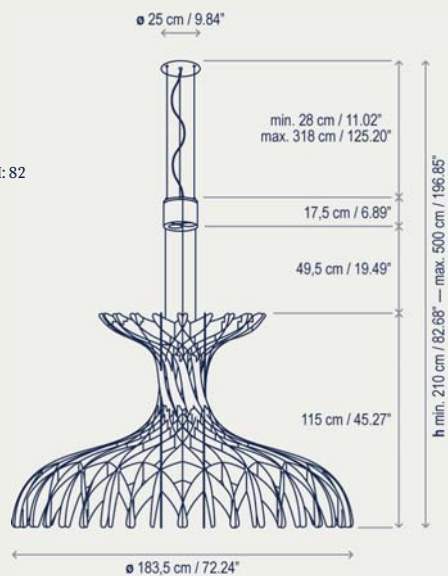

2581821000U DIM 0-10V Matte White
2581821012U DIM 0-10V Matte Black

Lampshade

P-812 Natural Wood Shade

Upon request Dome can be made with CRI 90 / 3000 degrees Kelvin

Finishing



Natural Wood

Dome

Design: Benedetta Tagliabue/ EMBT | 2015



BEST of year INTERIOR DESIGN
HONOREE 2015

The integration of design, art and light in architecture dates back to a long time ago, and maybe this is the reason why lamps have gradually stopped being just an item emitting light to become a light sculpture which confers a special personality to the product and its environment. It is such the importance of light that any change on the item can alter the formal concept of the whole project. A sculpture may seem more or less static, depending on the light received. With DOME we decided to take the light out of the object so it becomes a light sculpture designed to receive and emit a delicate light, a play of shadows and nuances that enrich the space for which they were created. Developing this project with Benedetta has allowed us to reflect on the art of lighting, on how to reinterpret light and on the creation of products with a more artistic approach and a less industrial look. It has also allowed us to be swept away and do what we really like to do. These light sculptures are completely handmade and they are entirely produced in the Bover Barcelona HQ. More than 170 big and small wood fragments are wisely intertwined and sewed one by one to end up in such a jigsaw puzzle.







“Dome is a light sculpture which proposes a play of shadows and delicate light, born in the mediterranean. Only Bover could make it possible.”



Benedetta Tagliabue.
BENEDETTA TAGLIABUE, EMBT



Contemporary / Pendant Lamp

Elea - 55

-  120V-60Hz
- 
-  4 x 60 W E26 A15 INC
-  4 x 10 W E26 A19 LED
-  4 x 20 W E26 Triple CFL

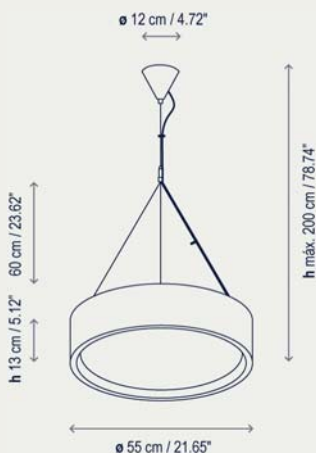



- 410232401U White Brilliant Lacquer
- 410232423U Black Brilliant Lacquer
- 410232422U Red Brilliant Lacquer

Finishing: Brilliant lacquer finish
Material: Polyurethane
Optical glass diffuser

LED option available

Elea - 85

Big Format

-  120 - 277V
50 - 60Hz
- 
-  4 x 55 W 2G11 Twin CFL





- 410332401U White Brilliant Lacquer
- 410332423U Black Brilliant Lacquer
- 410332422U Red Brilliant Lacquer

- D410332401U* Dim 0-10V / White Brilliant Lacquer
- D410332423U* Dim 0-10V / Black Brilliant Lacquer
- D410332422U* Dim 0-10V / Red Brilliant Lacquer

* Dimming Ballast (Dim 0-10V)

Finishing: Brilliant lacquer finish
Material: Polyurethane
Optical glass diffuser

Elea - LP 95

-  120 - 277V
50 - 60Hz
- 
-  2 x 39W Minibipin T5 L. FLUO

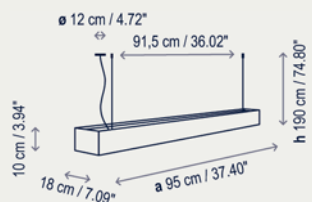

- 3330121101U White Brilliant Lacquer
- 3330121122U Red Brilliant Lacquer
- 3330121123U Black Brilliant Lacquer

- 3330121201U* Dim 0-10V / White Brilliant Lacquer
- 3330121222U* Dim 0-10V / Red Brilliant Lacquer
- 3330121223U* Dim 0-10V / Black Brilliant Lacquer

* Dimming Ballast (Dim 0-10V)

Finishing: Polyurethane/brilliant lacquer finish

Family

påg 114 114 114 164 164



Finishing

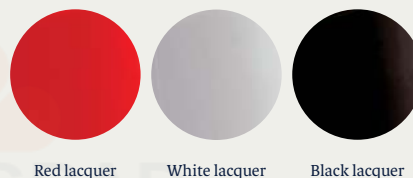

Elea

by Joana Bover | 2013





ELEA collection is an absolutely contemporary and non-temporal product because of its cylindrical and flat format. These products are made of polyurethane with a brilliant lacquered finish. The dimming versions have been created to offer a greater sense of comfort. Upper and bottom diffuser included. Elea collection is available in two sizes both for ceiling and pendant version.

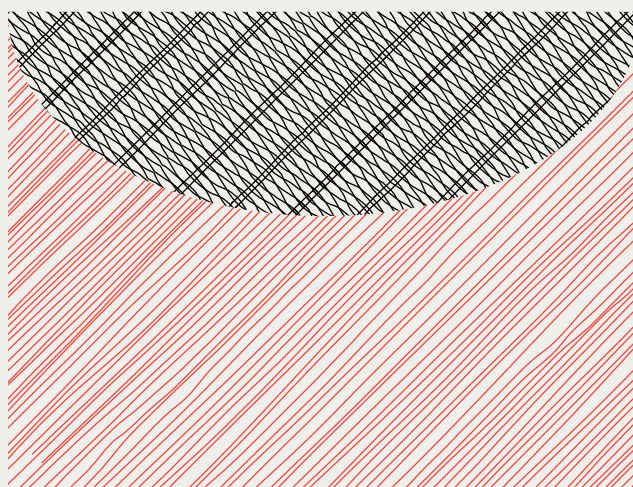







Contemporary / Pendant Lamp

Elipse - 30

120V-60Hz 

2 x 20 W E26 TRIPLE CFL

2 x 10 W E26 A19 LED

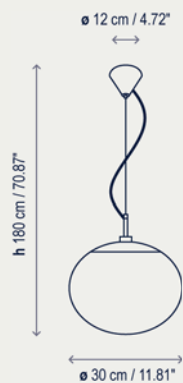

4032301U Ball 30 - White
4032305U Ball 30 - Nickel

Polyethylene globe of medium density and UV/light protection.

Elipse - 50

120V-60Hz 

2 x 29 W E26 TRIPLE CFL

2 x 10 W E26 A19 LED

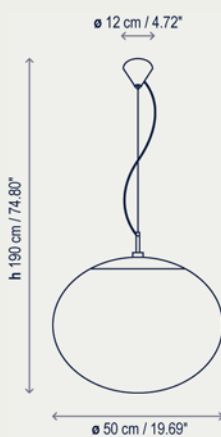

4132301U Ball 50 - White
4132305U Ball 50 - Nickel

Polyethylene globe of medium density and UV/light protection.



Elipse

by Alex Fernández Camps / Gonzalo Milà | 2011







Contemporary / Pendant Lamp

Garota - S / 01 Indoor

Pendant Lamp

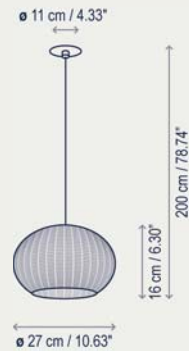

3350120201U Natural White
3350120203U Brown Graphite

P-803 Ivory White
P-804 Brown

Aluminium shade frame and canopy
Transparent wire

Family

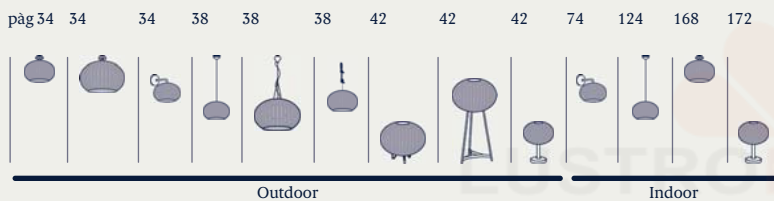

All Bover's synthetic fiber collection are recyclable and non-toxic for environmental sustainability.

Finishing

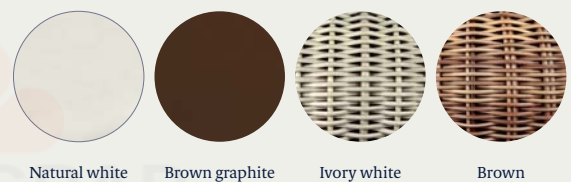

Natural white

Brown graphite

Ivory white

Brown

Garota Indoor

by Alex Fernández Camps / Gonzalo Milá | 2015



Contemporary / Pendant Lamp

Hardy

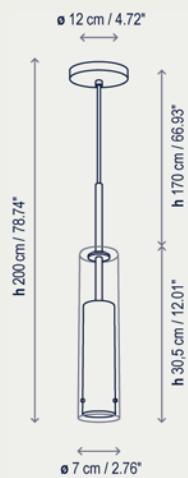

- 4131206U Chrome - Glass
- 4131221U White - Glass
- 4131299U Gold - Glass

LED bulb included
Only suitable for led bulbs, Max 5 W
Adjustable wire
Material: Borosilicate glass

Finishing



Brilliant chrome

White

Gold

Hardy

by Sergi Devesa / Òscar Devesa | 2013

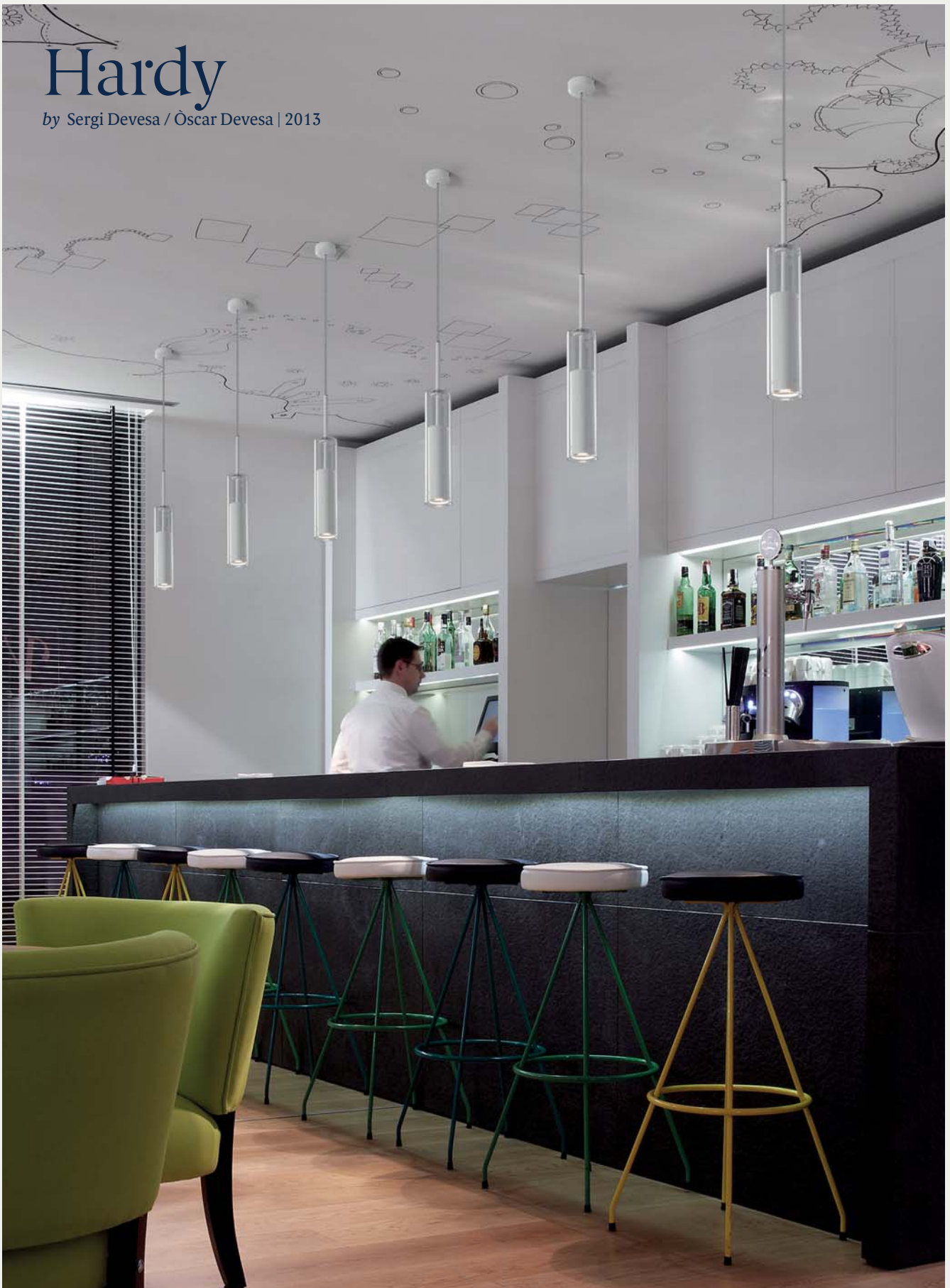

Hotel Vincci Bit / Barcelona



HARDY is clearly oriented to the Contract/Hospitality sector thanks to its features. These luminaires are made with borosilicate glass and a warm white LED as light source to bring efficient illumination without glare and provide easy maintenance. Includes an inner decorative cylinders in chrome, white and gold finishes.



Contemporary / Pendant Lamp

Inari - S

120V-60Hz 

3 x 60 W E26 A15 INC

3 x 5 W E26 A15 LED

3 x 13 W GU24 T2 CFL

3 x 10 W GU24 A15 LED

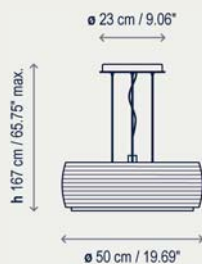

4120205U Nickel-Opal Glass
4120206U Chrome-Opal Glass

4120205GU Nickel-Opal Glass / GU24
4120206GU Chrome-Opal Glass / GU24

Optical glass diffuser

Important note: Due to the nature of the hand blown crystal, natural variations should be expected and will not be considered an imperfection.

Family

page 130 174 190



Finishing

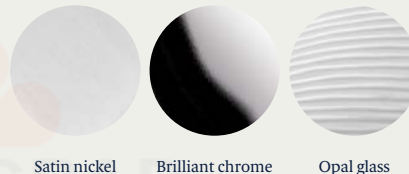

Inari

by Joana Bover | 2010

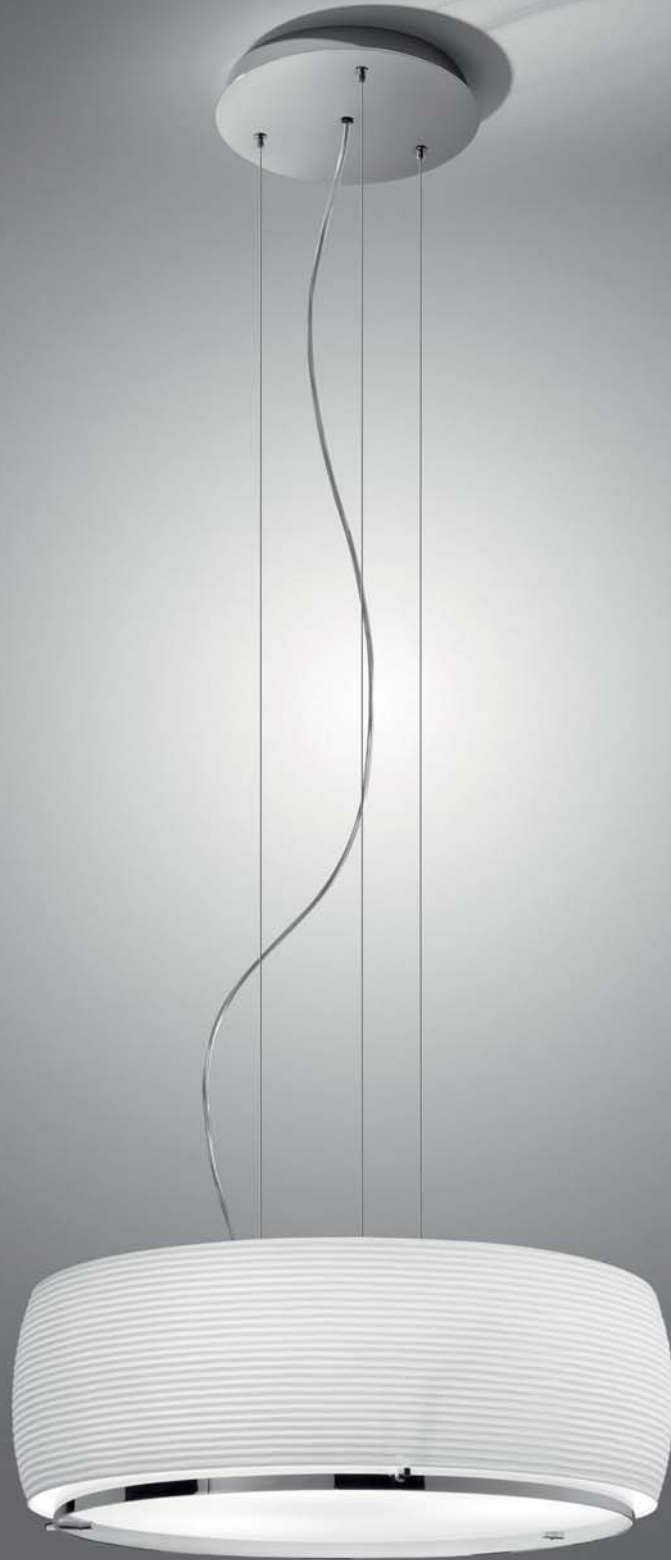



INARI is a collection of opal blown glass lamps, having its main feature on the irregularity of its lines which confer form and character to the product and emit a soft, cozy and diffuse light with a greater comfort degree. The organic shape hide its light source inside, without diminishing the role of its engraving and line design. This family consist of a pendant lamp, table, and floor light arriving from a common graphic concept, however they are completely diferent. Table and floor lamp incorporate dimming version.

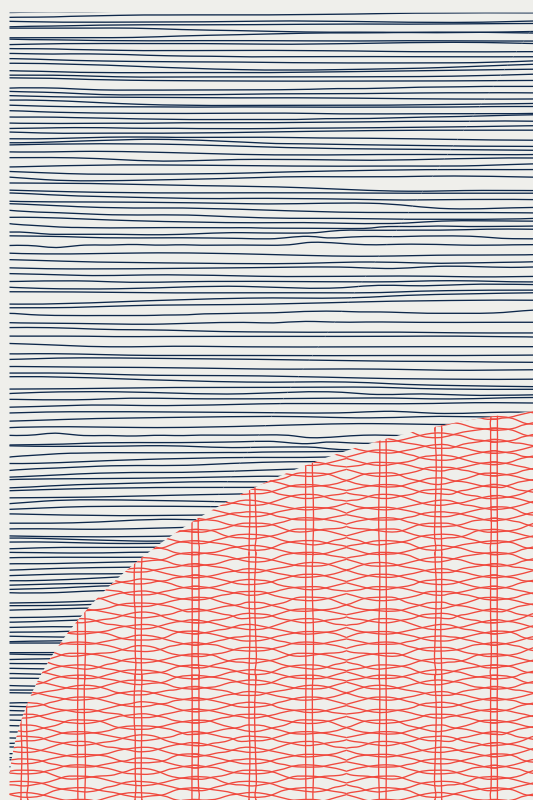



Contemporary / Pendant Lamp

Nón Lá - S

120 - 277V
50 - 60Hz



10,5 W LED | Led 35 x 0,3 W = 10,5 W
Lumens 1200 lm - CRI 90
Degrees Kelvin 2700^º



- 3320120401U Dim 0-10V White Brilliant Lacquer
White Canopy - White Wire
- 3320120406U Dim 0-10V Chrome
White Canopy - Transparent Wire
- 3320120423U Dim 0-10V Black Brilliant Lacquer
Black Canopy - Black Wire
- 3320120490U Dim 0-10V Brilliant Copper
Black Canopy - Black Wire

Adjustable shade
Aluminium hood

Family

pàg 82 82 82 82 134 138 138 138 178

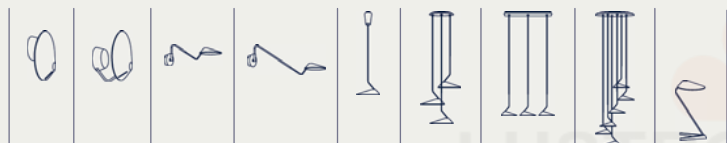

Finishing

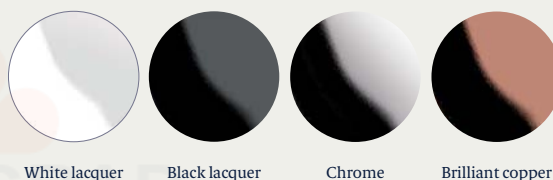

Nón Lá

by Jorge Pensi Design Studio | 2015





Jorge Pensi Design Studio



Delta Finalist
ADI Awards
2016

BEST of year INTERIOR DESIGN
HONOREE 2015



Contemporary / Pendant Lamp

Nón Lá - Set 3 Circular

120 - 277V
50 - 60Hz



31,5 W LED Led 3 * 35 x 0,3 W = 31,5 W
Lumens 3600 lm · CRI 90
Degrees Kelvin 2700²

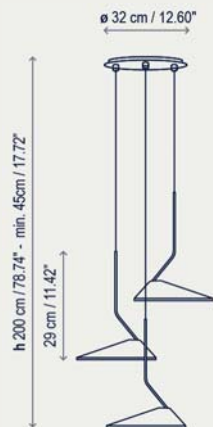

- 3320320401U Dim 0-10V White Brilliant Lacquer
White Canopy - White Wire
- 3320320406U Dim 0-10V Chrome
White Canopy - Transparent Wire
- 3320320423U Dim 0-10V Black Brilliant Lacquer
Black Canopy - Black Wire
- 3320320490U Dim 0-10V Brilliant Copper
Black Canopy - Black Wire

Adjustable shade
Aluminium hood

Nón Lá - Set 3 Rectangular

120 - 277V
50 - 60Hz



31,5 W LED Led 3 * 35 x 0,3 W = 31,5 W
Lumens 3600 lm · CRI 90
Degrees Kelvin 2700²

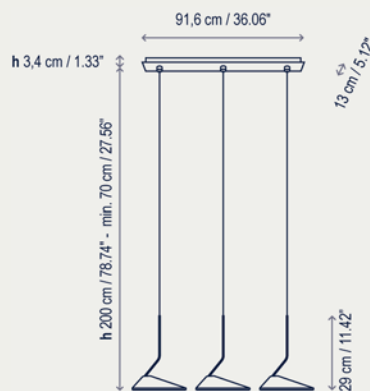

- 3320420401U Dim 0-10V White Brilliant Lacquer
White Canopy - White Wire
- 3320420406U Dim 0-10V Chrome
White Canopy - Transparent Wire
- 3320420423U Dim 0-10V Black Brilliant Lacquer
Black Canopy - Black Wire
- 3320420490U Dim 0-10V Brilliant Copper
Black Canopy - Black Wire

Adjustable shade
Aluminium hood

Nón Lá - Set 6 Circular

120 - 277V
50 - 60Hz



63 W LED Led 6 * 35 x 0,3 W = 63 W
Lumens 7200 lm · CRI 90
Degrees Kelvin 2700²

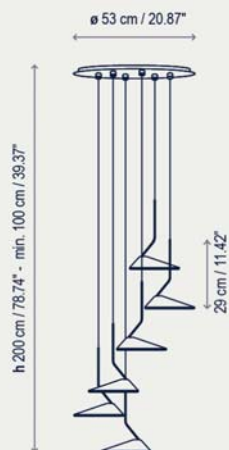

- 3320620401U Dim 0-10V White Brilliant Lacquer
White Canopy - White Wire
- 3320620406U Dim 0-10V Chrome
White Canopy - Transparent Wire
- 3320620423U Dim 0-10V Black Brilliant Lacquer
Black Canopy - Black Wire
- 3320620490U Dim 0-10V Brilliant Copper
Black Canopy - Black Wire

Adjustable shade
Aluminium hood

Family

pàg 82 82 82 82 134 138 138 138 178

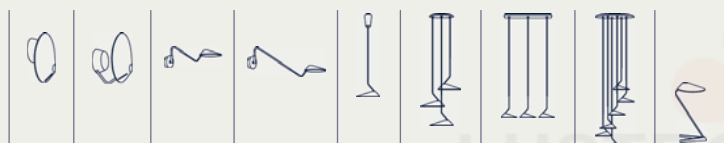

Finishing

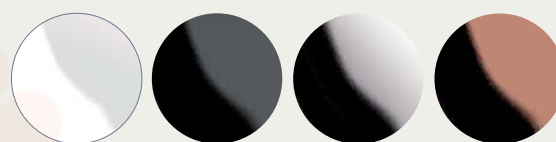

White lacquer

Black lacquer

Chrome

Brilliant copper

Nón Lá

by Jorge Pensi Design Studio | 2015







Contemporary / Pendant Lamp

Slend - 01

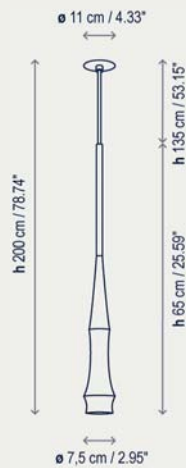

- 2560120064U Polished Aluminum - Chrome Canopy - Transp. Wire
- 2560120001U Brilliant White - White Canopy - White Wire
- 2560120023U Brilliant Black - Black Canopy - Black Wire

Special colors: RAL number to be indicated. Minimum quantity: 5 pieces.

Adjustable height by the user
LED bulb included

Slend - 02

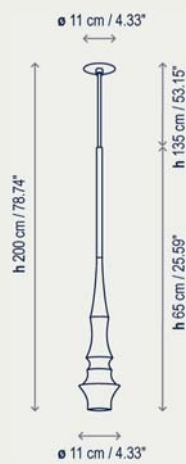

- 2560220064U Polished Aluminum - Chrome Canopy - Transp. Wire
- 2560220001U Brilliant White - White Canopy - White Wire
- 2560220023U Brilliant Black - Black Canopy - Black Wire

Special colors: RAL number to be indicated. Minimum quantity: 5 pieces.

Adjustable height by the user
LED bulb included

Slend - 03

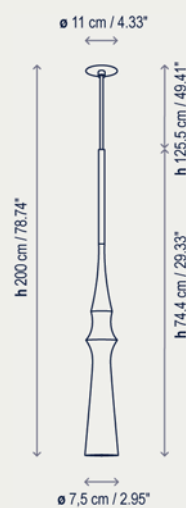

- 2560320064U Polished Aluminum - Chrome Canopy - Transp. Wire
- 2560320001U Brilliant White - White Canopy - White Wire
- 2560320023U Brilliant Black - Black Canopy - Black Wire

Special colors: RAL number to be indicated. Minimum quantity: 5 pieces.

Adjustable height by the user
LED bulb included



Finishing

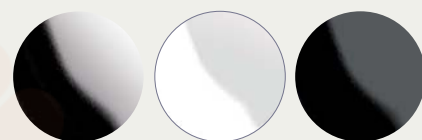

Matte finish available
please consult

Polished aluminum Brilliant white Brilliant black

Slend

by Christophe Mathieu | 2014



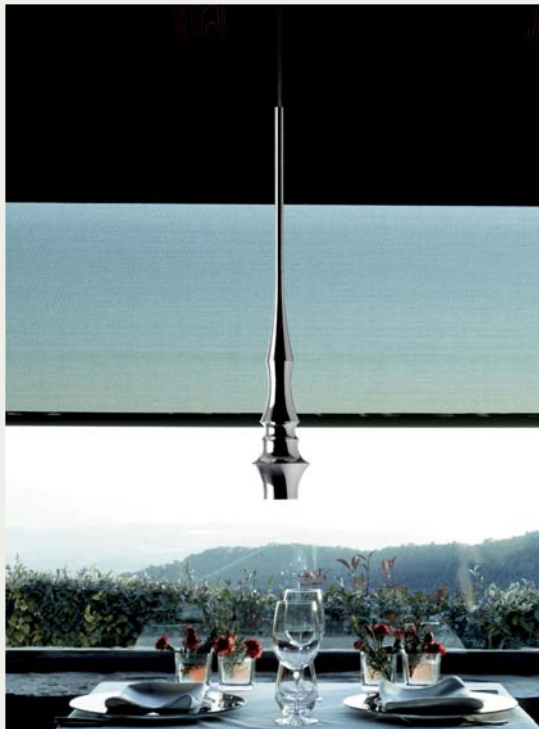
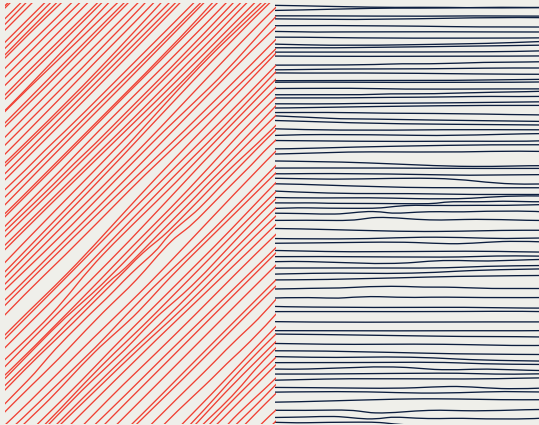

Hotel Can Cuc / Cànoves

SLEND'S main goal is to make spaces elegant throughout slim and delicate shapes. These lights have three different formats which can be combined as desired, achieving a large range of applications. We can show them individually or grouped in different heights. Slend is made out of spun aluminum and includes the led bulb inside, which can be easily replaced. The direct light and the bulb with a 100° light opening makes Slend an excellent choice for spaces and objects we want to light up (restaurant tables, store counters, stairwells...).

INTERIOR DESIGN
BEST OF YEAR HONOREE 2014



Christophe Mathieu



Contemporary / Pendant Lamp

Slend - Set 3 Circular

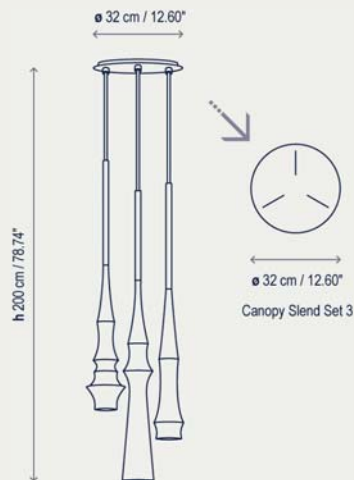

2560420064U Polished Aluminum - White Canopy - Transp. Wire
2560420001U Brilliant White - White Canopy - White Wire
2560420023U Brilliant Black - Black Canopy - Black Wire

LED bulb included
Adjustable height by the user
Includes a fitting of each (Slend 01, 02, 03) with the same finishings.

Special colors: RAL number to be indicated. Minimum quantity: 5 pieces.

Slend - Set 3 Rectangular

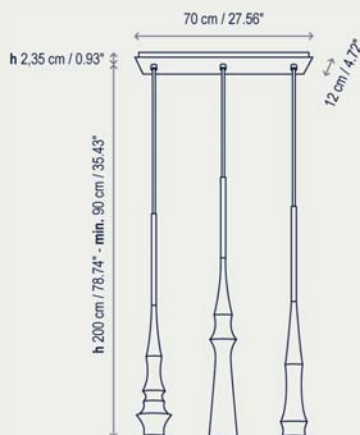

2560620064U Polished Aluminum - White Plate - Transp. Wire
2560620001U Brilliant White - White Plate - White Wire
2560620023U Brilliant Black - Black Plate - Black Wire

LED bulb included
Adjustable height by the user
Includes a fitting of each (Slend 01, 02, 03) with the same finishings.

Special colors: RAL number to be indicated. Minimum quantity: 5 pieces.

Slend - Set 6 Circular

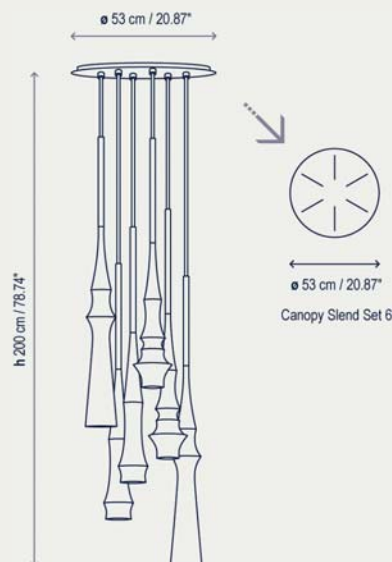

2560520064U Polished Aluminum - White Canopy - Transp. Wire
2560520001U Brilliant White - White Canopy - White Wire
2560520023U Brilliant Black - Black Canopy - Black Wire

LED bulb included
Adjustable height by the user
Includes two fittings of each (Slend 01, 02, 03) with the same finishings.

Special colors: RAL number to be indicated. Minimum quantity: 5 pieces.

Finishing

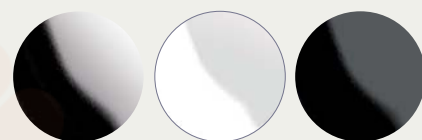

Matte finish
available
please consult

Polished aluminum Brilliant white Brilliant black



Matte finish available please consult





Contemporary / Pendant Lamp

Syra 45 Indoor

120 - 277V
50 - 60Hz



17 W LED
Led: 54 x 0.33 W = 17 W
Lumens: 2050 lm · CRI: 90
Degrees Kelvin: 2700²

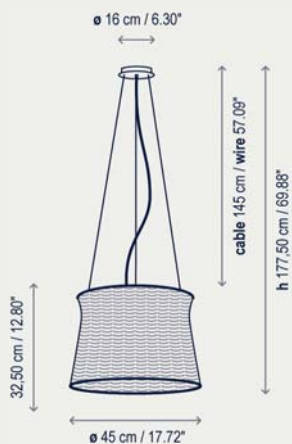

- 2640120158U White
- 2640120159U Chocolate Brown
- 2640121058U Dimming 0-10V / White
- 2640121059U Dimming 0-10V / Chocolate Brown

Syra 45 is not suitable for the Outdoors.

Family

pàg 52 52



Syra - 60 / 90
Outdoor

150



Syra - 45
Only Indoor
Application

Finishing

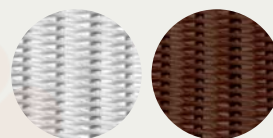

White

Chocolate brown



Syra 45 Indoor

by Alex Fernández Camps / Gonzalo Milà | 2014



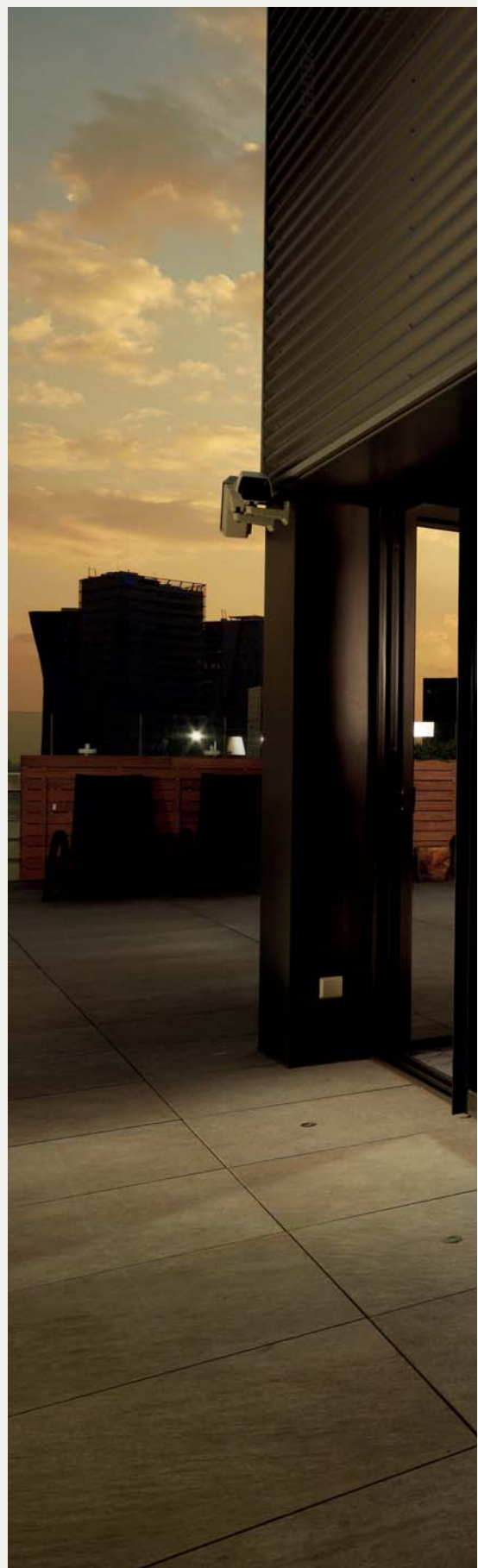
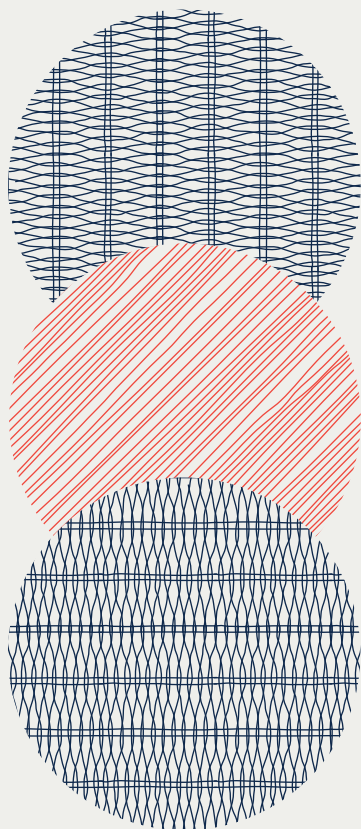



Hotel SB Europa / D. Alado

Contemporary / Pendant Lamp

Tibeta - 01



120V-60Hz

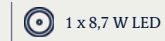

1 x 8,7 W LED

Led 8,7 W
Lumens 610 lm · CRI >80
Degrees Kelvin 2900^o-3200^o

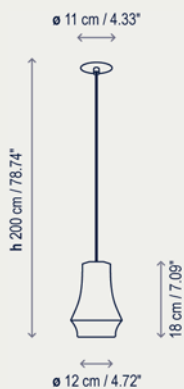

- 2570120107U Black Chrome - Black Fabric Wire
- 2570120164U Polished Aluminum - Grey Fabric Wire
- 2570120190U Brilliant Copper - Copper Metallic Mesh

Triac Dimmable (like retrofit dimmable led bulbs)

Tibeta - 02



120V-60Hz



1 x 8,7 W LED

Led 8,7 W
Lumens 610 lm · CRI >80
Degrees Kelvin 2900^o-3200^o

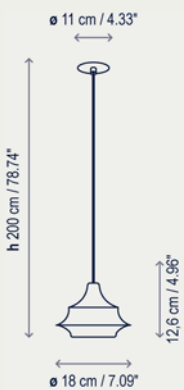

- 2570220107U Black Chrome - Black Fabric Wire
- 2570220164U Polished Aluminum - Grey Fabric Wire
- 2570220190U Brilliant Copper - Copper Metallic Mesh

Triac Dimmable (like retrofit dimmable led bulbs)

Tibeta - 03



120V-60Hz

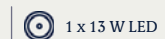

1 x 13 W LED

Led 13 W
Lumens 935 lm · CRI >80
Degrees Kelvin 2900^o-3200^o

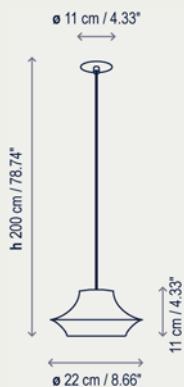

- 2570320107U Black Chrome - Black Fabric Wire
- 2570320164U Polished Aluminum - Grey Fabric Wire
- 2570320190U Brilliant Copper - Copper Metallic Mesh

Triac Dimmable (like retrofit dimmable led bulbs)



Finishing



Black chrome Polished aluminum Brilliant copper

Tibeta

by Christophe Mathieu | 2015



Contemporary / Pendant Lamp

Tibeta - Set3

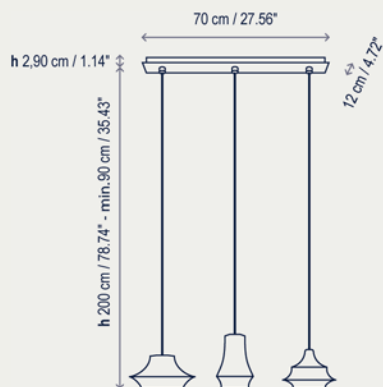
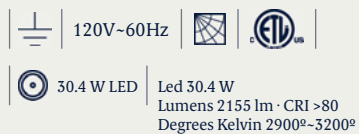

- 2570420107U Black Chrome
Black Fabric Wire - Black Canopy
- 2570420164U Polished Aluminum
Grey Fabric Wire - White Canopy
- 2570420190U Brilliant Copper
Copper Metallic Mesh - White Canopy

Triac Dimmable (like retrofit dimmable led bulbs)

Finishing



Black chrome Polished aluminum Brilliant copper





TIBETA is a family of pendant lights made of a spun aluminum body. It is available in three different sizes and shapes which can be used either individually or in groups of three or more units according to client's needs. Tibeta includes an LED module inside, which provides direct bottom light.





Contemporary / Ceiling Lamp

Cala - PF

120V-60Hz 

4 x 20 W E26 Triple CFL 

4 x 10 W E26 A19 LED 

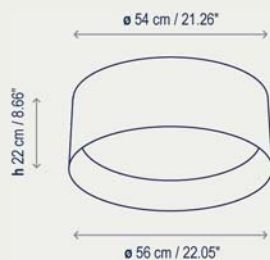

5132601U White Brilliant Lacquer
5132623U Black Brilliant Lacquer
5132622U Red Brilliant Lacquer

Finishing: Polyurethane/brilliant lacquer finish

Optical glass diffuser

LED option available



Family

påg 102 160



Finishing

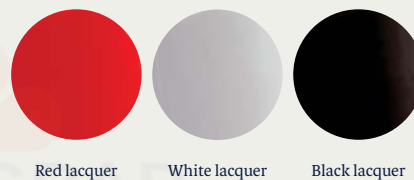

Cala

by Jordi Llopis | 2013







Contemporary / Ceiling Lamp

Elea - 55

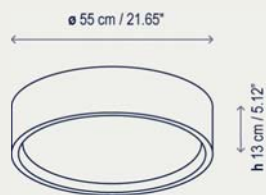
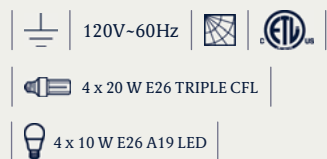

510232401U White Brilliant Lacquer
 510232423U Black Brilliant Lacquer
 510232422U Red Brilliant Lacquer

Finishing: brilliant lacquer finish
 Material: Polyurethane
 Optical glass diffuser

LED option available

Elea - 85 Big Format

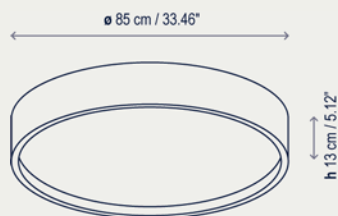

510332401U White Brilliant Lacquer
 510332423U Black Brilliant Lacquer
 510332422U Red Brilliant Lacquer
 D510332401U* Dim 0-10V / White Brilliant Lacquer
 D510332423U* Dim 0-10V / Black Brilliant Lacquer
 D510332422U* Dim 0-10V / Red Brilliant Lacquer

* Dimming Ballast (Dim 0-10V)

Finishing: Brilliant lacquer finish
 Material: Polyurethane
 Optical glass diffuser

Family

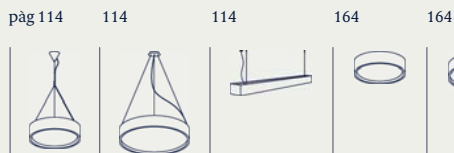

Finishing

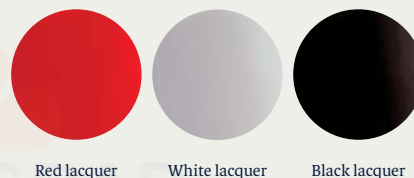

Elea

by Joana Bover | 2013



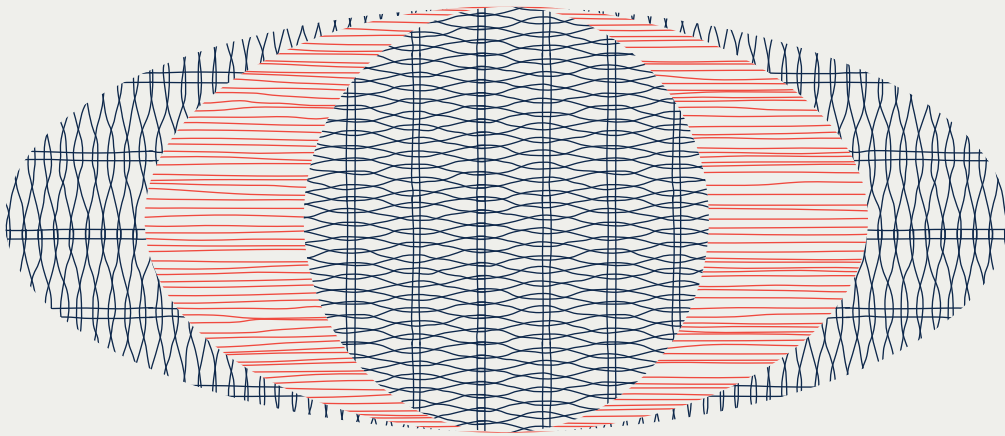



Contemporary / Ceiling Lamp

Garota - PF / 01 Indoor

Ceiling Lamp

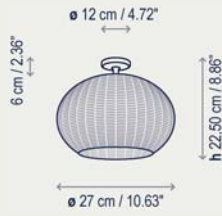

3350110001U Natural White
3350110003U Brown Graphite

P-803 Ivory White
P-804 Brown

Aluminium shade structure and canopy

Family

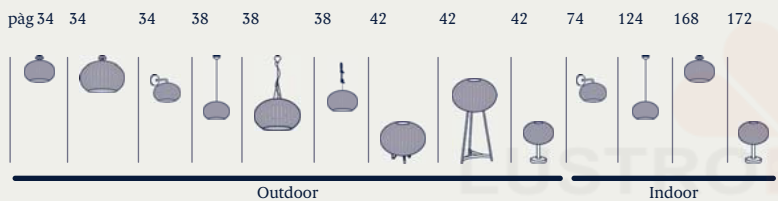

All Bover's synthetic fiber collection are recyclable and non-toxic for environmental sustainability.

Finishing

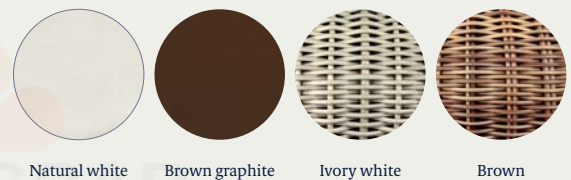

Garota Indoor

by Alex Fernández Camps / Gonzalo Milà | 2015



Contemporary / Table Lamp

Club - T

120V-60Hz 

 1 x 60 W E26 A15 INC

 1 x 5 W E26 A15 LED

 1 x 13 W E26 T3 CFL



1932812U Matte Black-Nickel

Black aluminum shade
White PVC interior B1 Flame Resistant
Included aluminum top diffuser

Swivel base
Pull string switch
Transparent wire



Family

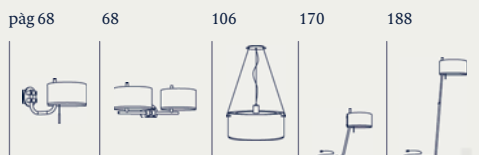

Finishing

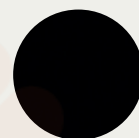

Matte black

Club

by Luis Viñas | 2012



Contemporary / Table Lamp

Garota - Mini Indoor

Mini Table Lamp

IP-20	120V-60Hz		
 1 x 60 W E26 A15 Inc	 1 x 5 W E26 A15 Led		



3350630001U	Natural White
3350630003U	Brown Graphite

P-803	Ivory White
P-804	Brown

Aluminium shade frame

Transparent switch + wire

The Garota Indoor 01 is designed for indoor applications that do not require the technical specifications incorporated within our outdoor products. For this reason we do not need the polyethylene ellipse to ensure a seal on the light source / IP -55. The LED plate from the outdoor version has been replaced by an E-27 socket for interior use. The electric cable is transparent and the ceiling canopy or wall mounting is made of iron with white or brown finish.

Family

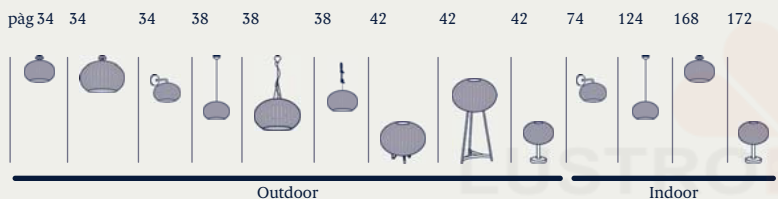

All Bover's synthetic fiber collection are recyclable and non-toxic for environmental sustainability.

Finishing

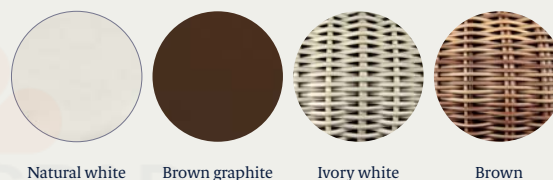

Natural white

Brown graphite

Ivory white

Brown

Garota Indoor

by Alex Fernández Camps / Gonzalo Milà | 2015



Contemporary / Table Lamp

Inari - T

- 120V-60Hz 
-  3 x 60 W
E26 A15 INC
-  3 x 5 W
E26 A15 LED
-  3 x 18 W
GU24 T3 CFL
-  3 x 10 W
GU24 A15 LED



- 2220205U Nickel-Opal Glass
- 2220206U Chrome-Opal Glass
- 2220205GU Nickel-Opal Glass / GU24
- 2220206GU Chrome-Opal Glass / GU24

Lamp with incorporated dimmer
Transparent wire + white dimmer
Optical glass diffuser

Important note: Due to the nature of the hand blown crystal, natural variations should be expected and will not be considered an imperfection.

Family

pag 130 174 190



Finishing

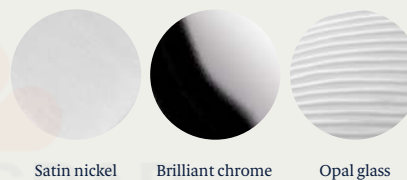

Inari

by Joana Bover | 2010



Contemporary / Table Lamp

Muf - 01

- 120V-60Hz 
- 1 x 100 W E26 A19 INC + 1 x 40 W E12 A15 INC
- 1 x 10 W E26 A19 LED + 1 x 4.8 W E12 A15 LED



2215521U Blown Opal Crystal-Chrome

P-561* White Translucent Ribbon

Set of double lamp shades:

P-564E* Black Mesh

P-564** Black Mesh

P-565E* Red Mesh

P-565** Red Mesh

* Outer lampshade: 10.63" x 10.63" x 7.87"

** Inner lampshade : 7.87" x 10.24" x 5.51"

Inner shade made of a fire-resistant polyester rigid film

With 3 lighting/mood switch on/off positions

White wire + switch

Important note: due to the nature of the hand blown crystal, natural variations should be expected and will not be considered an imperfection.

Muf - 02

- 120V-60Hz 
- 1 x 100 W E26 A19 INC + 2 x 40 W E12 A15 INC
- 1 x 10 W E26 A19 LED + 2 x 4.8 W E12 A15 LED

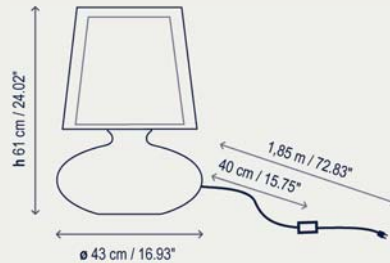

2215522U Blown Opal Crystal-Chrome

P-580* White Translucent Ribbon

Set of double lamp shades:

P-570E* Black Mesh

P-570** Black Mesh

P-571E* Red Mesh

P-571** Red Mesh

* Outer lampshade: 15.75" x 14.17" x 12.20"

** Inner lampshade : 11.81" x 11.81" x 9.06"

With 3 lighting/mood switch on/off positions

Inner shade made of a fire-resistant polyester rigid film

White wire + switch

Important note: due to the nature of the hand blown crystal, natural variations should be expected and will not be considered an imperfection.



Finishing

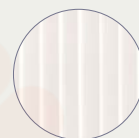

White ribbon

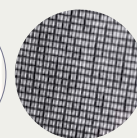

Black mesh

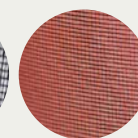

Red mesh

Muf

by Joana Bover | 2007



Hotel Villa Emilia / Barcelona

Contemporary / Table Lamp

Nón Lá - T

120V-60Hz  

 10,5 W LED | Led 35 x 0,3 W = 10,5 W
Lumens 1200 lm · CRI 90
Degrees Kelvin 2700²



- 3320130301U White Brilliant Lacquer
- 3320130306U Chrome
- 3320130323U Black Brilliant Lacquer
- 3320130390U Brilliant Copper

Switch with three brightness levels

Family

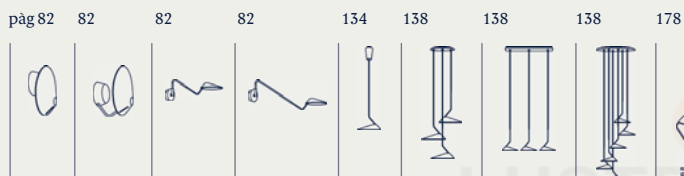

Finishing

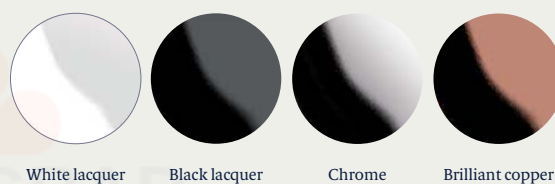

Nón Lá

by Jorge Pensi Design Studio | 2015



Contemporary / Table Lamp

Onne

- 120V-60Hz 
-  1 x 100 W E26 A19 INC
-  1 x 10 W E26 A19 LED
-  1 x 18 W GU24 T3 CFL
-  1 x 12 W GU24 A19 LED

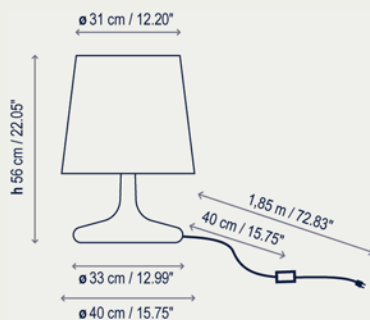

- 2210621U White Brilliant Lacquer
- 2210617U Black Brilliant Lacquer
- 2210622U Red Brilliant Lacquer
- 2210621GU White Brilliant Lacquer /GU24
- 2210617GU Black Brilliant Lacquer /GU24
- 2210622GU Red Brilliant Lacquer /GU24

Lampshade 15.75" x 13.98" x 12.20"
 Diffuser included: silver-mirror glass with white shade and black-mirror glass with black and red shade

- P-660U White Translucent Ribbon
- P-761U Red Translucent Ribbon
- P-658U Black Fabric - Orange Inside
- P-659U White Fabric - Orange Inside

Base: Polyurethane/brilliant lacquer finish
 Transparent wire + switch



Finishing



Red lacquer White lacquer Black lacquer White ribbon Red ribbon White fabric Orange inside Black fabric Orange inside

Onne

by Joana Bover | 2009







Contemporary / Table Lamp

Spock - T

120V~60Hz



3.6 W LED

Led: 12 x 0.3 W = 3.6 W
Lumens: 444 lm @80°C
CRI: 90 · Degrees Kelvin: 3000°

Drive Conector

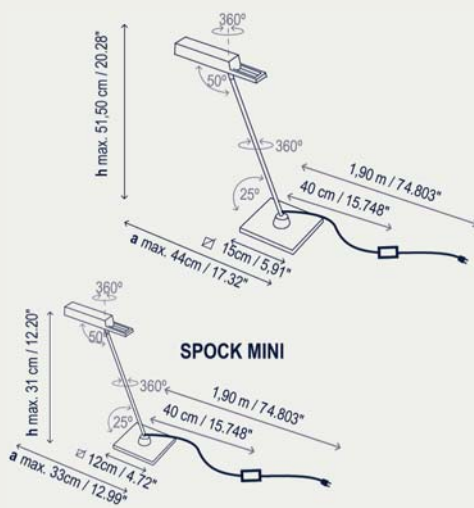
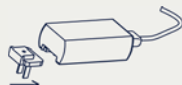

- 1910512LU Led Chrome
- 1910511LU Led Chrome-White

- Spock Mini
- 2010512LU Led Chrome
 - 2010511LU Led Chrome-White

Zamac injected orientable hood
Stainless steel base
Black wire + switch
Diffuser: Circular rotation 360° / Vertical rotation 50°
Mast: Circular rotation 360° / Mast inclination 25°

Family

påg 90 184 184 192

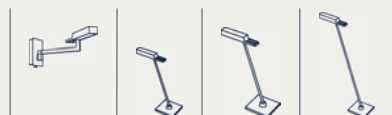

Finishing

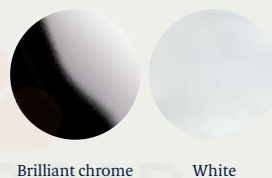

Spock

by Christophe Mathieu | 2007

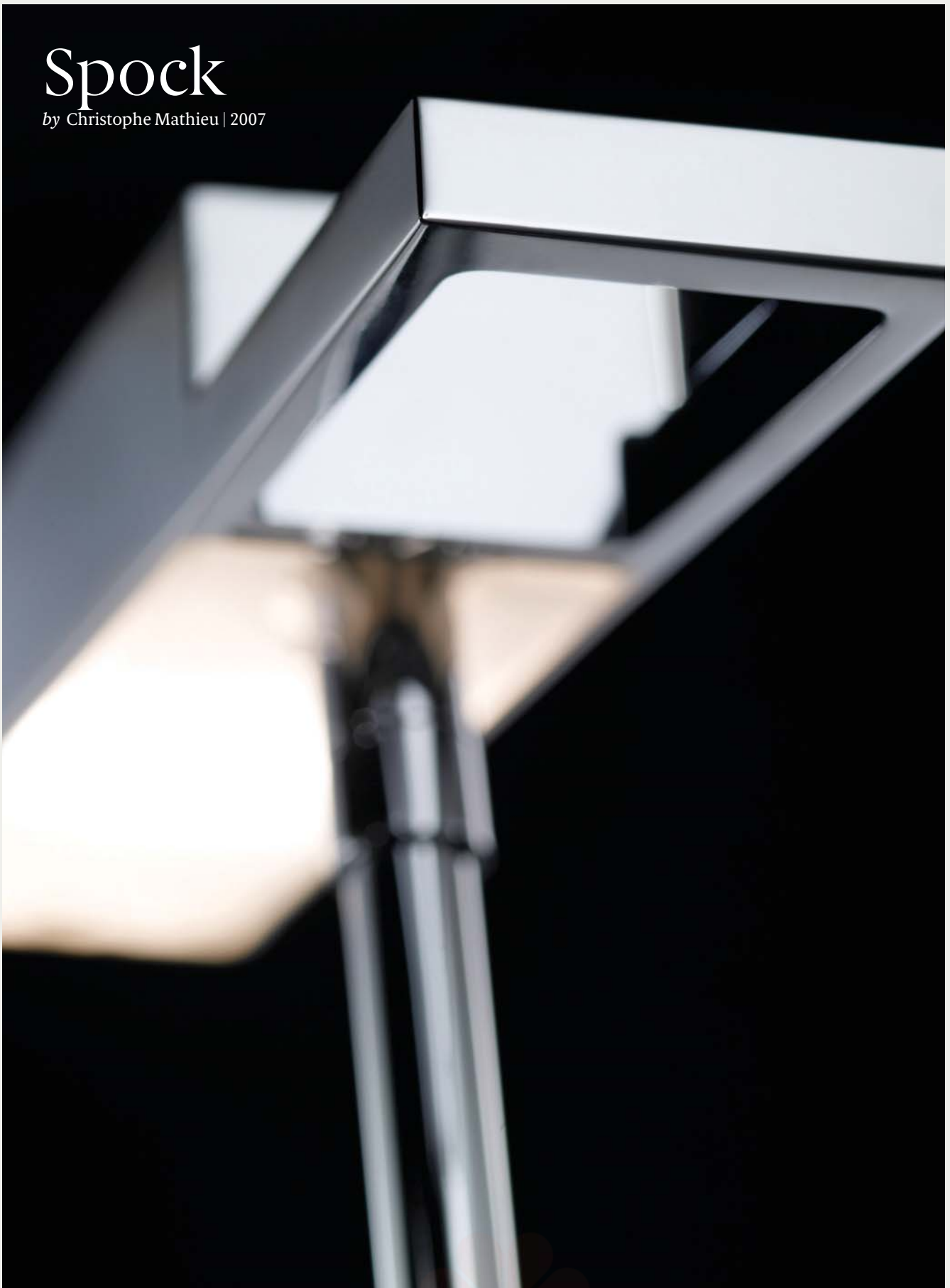



SPOCK lamps transmit a lightness appearance, thought and produced through the simplest and easiest design language, 'Less is more'. The Spock family, are reading lamps that offer us direct light concentrated through its 4 LEDS. The hood is adjustable and in case of table and floor lamp models, its hood has a circular movement of 360° and a maximum slope of its stem of 25°.



Contemporary / Floor Lamp

Club - P

120V-60Hz 

 1 x 60 W E26 A19 INC

 1 x 10 W E26 A19 LED

 1 x 15 W E26 T3 CFL

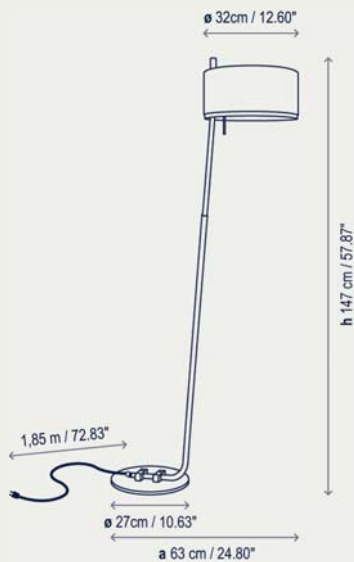

3132812U Matte Black-Nickel

Black aluminum shade
White PVC interior B1 Flame Resistant
Included aluminum top diffuser

Pull string switch
Black wire



Family

pág 68 68 106 170 188



Finishing

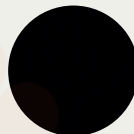

Matte black

Club

by Luis Viñas | 2012



Contemporary / Floor Lamp

Inari - P

120V-60Hz 

 3 x 60 W
E26 A15 INC

 3 x 5 W
E26 A15 LED

 3 x 18 W
GU24 T3 CFL

 3 x 10 W
GU24 A15 LED

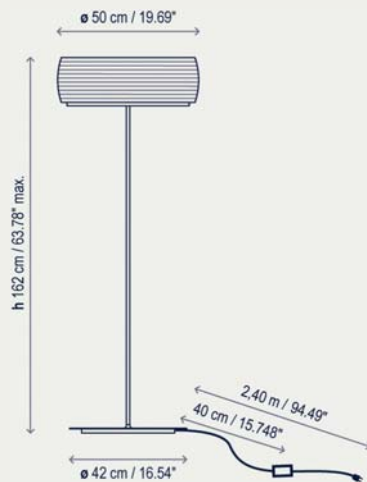

3020205U Nickel-Opal Glass
3020206U Chrome-Opal Glass

3020205GU Nickel-Opal Glass / GU24
3020206GU Chrome-Opal Glass / GU24

Lamp with incorporated dimmer
Black wire + black dimmer
Optical glass diffuser

Important note: Due to the nature of the hand blown crystal, natural variations should be expected and will not be considered an imperfection.

Family

pag 130 174 190

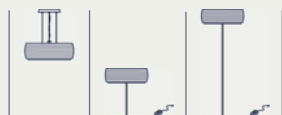

Finishing

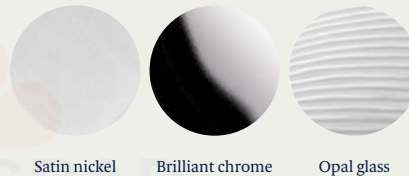

Inari

by Joana Bover | 2010



Contemporary / Floor Lamp

Spock - P

120V-60Hz



3.6 W LED

Led: 12 x 0.3 W = 3.6 W
Lumens: 444 lm @80°C
CRI: 90 · Degrees Kelvin: 3000º

Drive Conector

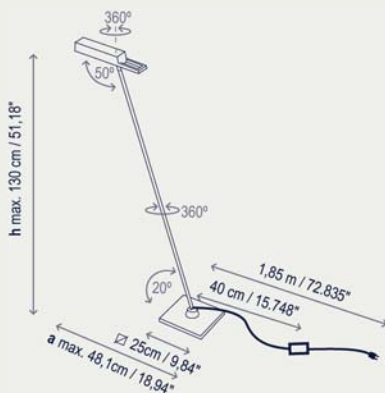
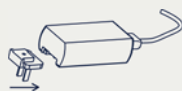

- 3110512LU Led Chrome
- 3110511LU Led Chrome-White

Zamac injected orientable hood
 Stainless steel base
 Black wire + switch
 Diffuser: Circular rotation 360º / Vertical rotation 50º
 Mast: Circular rotation 360º / Mast inclination 20º

Family

pag 90 184 184 192

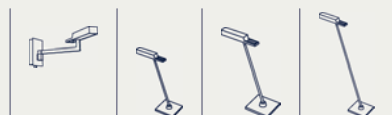

Finishing

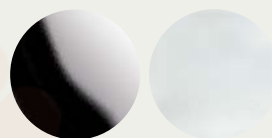

Brilliant chrome

White



Spock

by Christophe Mathieu | 2007



Ribbon

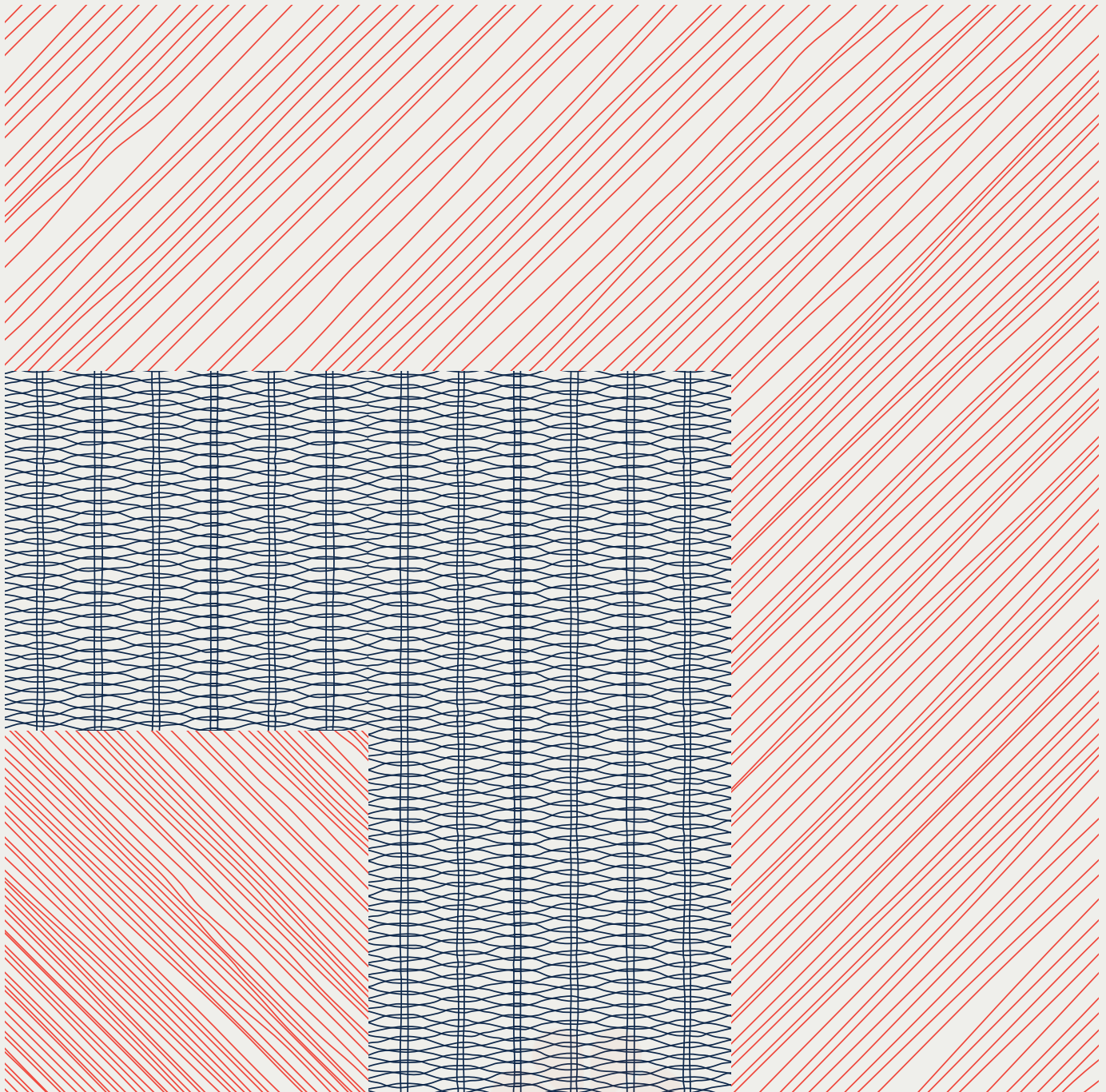

Ribbon / Wall Lamp

Basik - 02

120V-60Hz 

1 x 60 W E26 A15 INC

1 x 5 W E26 A15 LED

1 x 13 W GU24 T2 CFL

1 x 10 W GU24 A15 LED

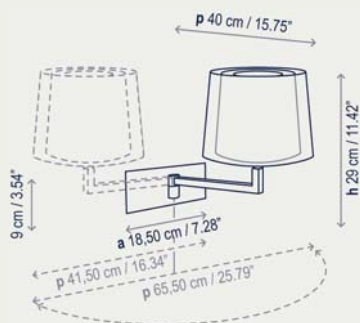

1132105U Satin Nickel
1132106U Brilliant Chrome

1132105GU Satin Nickel / GU24
1132106GU Brilliant Chrome / GU24

Outer Lampshade 8.66" x 6.30" x 7.09"
P-633E White Cotton
Cotton shade without upper diffuser

P-634E White Translucent Ribbon
P-635E Cream Translucent Ribbon

Set of double lamp shades:

P-636E* Black Mesh
P-6361** Black Mesh

P-637E* Red Mesh
P-6371** Red Mesh

* Outer lampshade: PVC crystal

** Inner lampshade

Inner shade made of a fireresistent polyester rigid film

Swivel arm

Surface back box: 6.69" x 3.15"

No switch included

Important Note: Must mount horizontally on 2" x 4" rectangular junction box.

Finishing

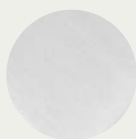

Satin nickel



Brilliant chrome



Black mesh

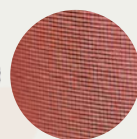

Red mesh

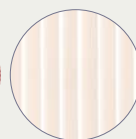

Cream ribbon



White ribbon



White cotton

Basik - 02

by Joana Bover 2010



Ribbon / Wall Lamp

BCN 01

 ADA | 120 - 277V
50 - 60Hz



 8.2 W LED | Led: 24 x 0,34 W = 8.2 W
Lumens: 840 lm · CRI: 90
Degrees Kelvin: 2700°

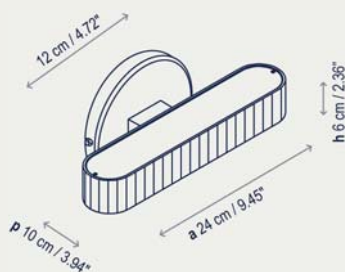

- 2650101147U Led DIM 0-10V Satin Nickel Cream Translucent Ribbon
- 2650101148U Led DIM 0-10V Satin Nickel White Translucent Ribbon
- 2650101149U Led DIM 0-10V Satin Nickel Red Translucent Ribbon

- 2650101150U Led DIM 0-10V Chrome Cream Translucent Ribbon
- 2650101151U Led DIM 0-10V Chrome White Translucent Ribbon
- 2650101152U Led DIM 0-10V Chrome Red Translucent Ribbon

Polycarbonate diffuser included

BCN 02

 ADA | 120V-60Hz



 11.5 W LED | Led: 28 x 0,41 W = 11.5 W
Lumens: 1060 lm · CRI: 90
Degrees Kelvin: 2700°

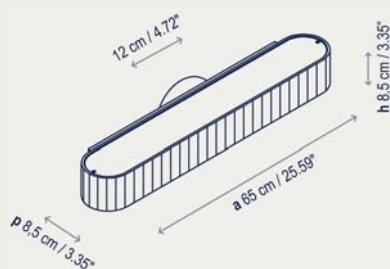

- 2650201153U Led DIM 0-10V White Cream Translucent Ribbon
- 2650201154U Led DIM 0-10V White White Translucent Ribbon
- 2650201155U Led DIM 0-10V White Red Translucent Ribbon

Polycarbonate diffuser included

 ADA | 120 - 277V
50 - 60Hz



 2 x 24W Minibipin T5 L. FLUO

- 2650201453U Fluorescent DIM 0-10V White Cream Translucent Ribbon
- 2650201454U Fluorescent DIM 0-10V White White Translucent Ribbon
- 2650201455U Fluorescent DIM 0-10V White Red Translucent Ribbon

Polycarbonate diffuser included

Important note:
Wall sconce product photography doesn't show US backplate mounting.

Finishing

pàg 64 | 198 | 198

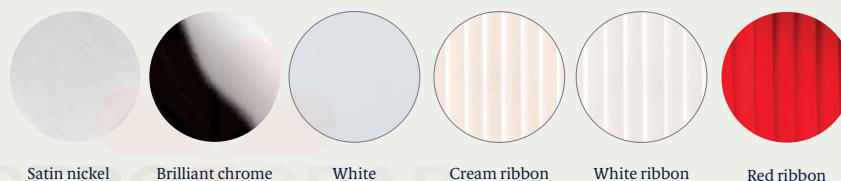

BCN

by Joana Bover | 2012



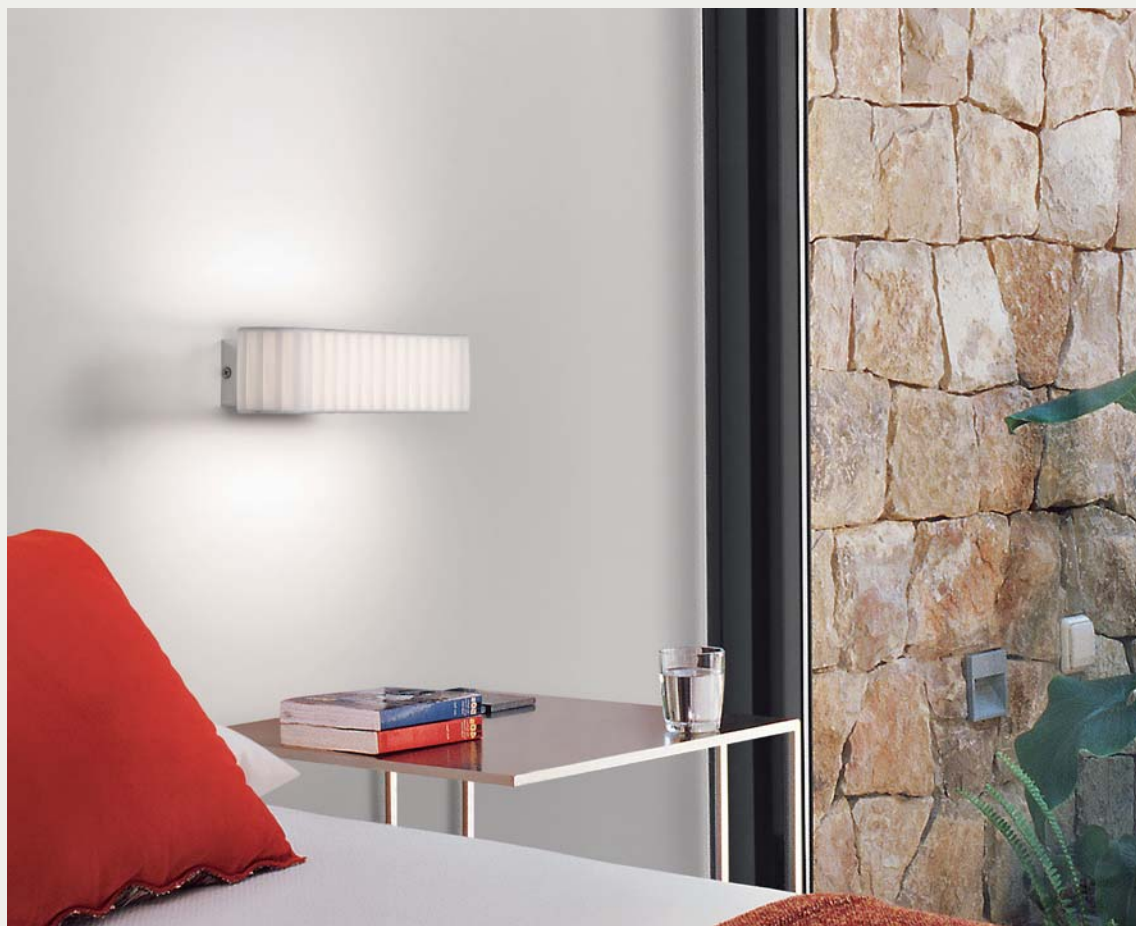

Barcelona is the home for Bover and inspiration for much of our lighting. BCN is the code used as shorthand for our city and has given the name to this fixture. In addition to the brilliant lacquered version of BCN we have increased this family to include a discreet, but sophisticated sconce fusing LED technology with our hand wrapped ribbon with top and lower diffuser in polycarbonate. BCN creates a contemporary but timeless fixture suited for hallways, vanities or anywhere a low profile sconce may be required. Available in 2 sizes, the larger having also a fluorescent option as well as LED.

Important note:
Wall sconce product photography
doesn't show US backplate mounting.



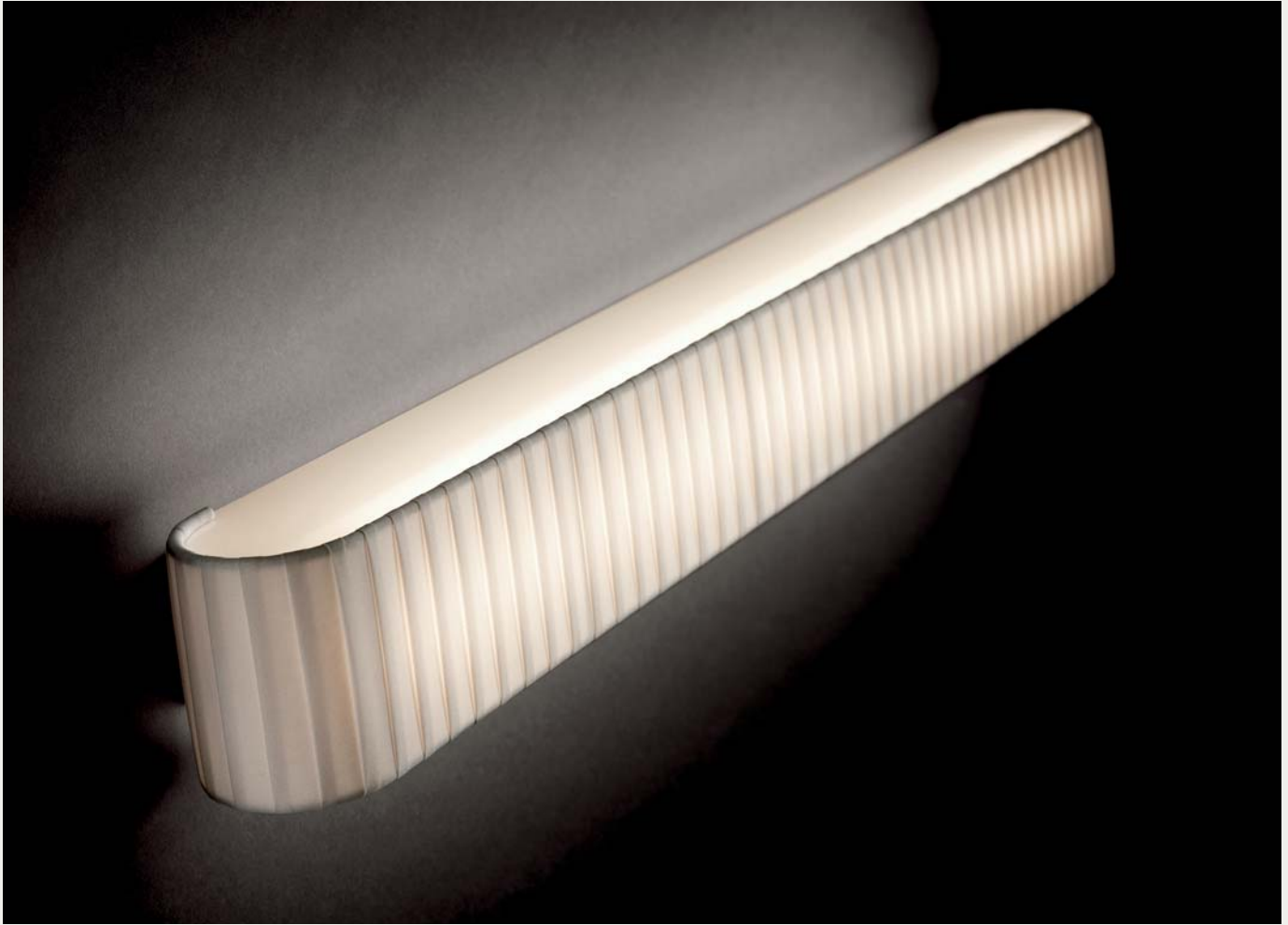

Important note:
Wall sconce product photography doesn't show US backplate mounting.



Ribbon / Wall Lamp

Carlota - A

	120V-60Hz	
	1 x 60 W E26 A15 INC	
	1 x 5 W E26 A15 LED	
	1 x 13 W GU24 T2 CFL	
	1 x 10 W GU24 A15 LED	



1024005U	Satin Nickel
1024006U	Brilliant Chrome
1024060U	Nickel Dark Leather
1024061U	Nickel Caramel Leather
1024005GU	Satin Nickel / GU24
1024006GU	Brilliant Chrome / GU24
1024060GU	Nickel Dark Leather / GU24
1024061GU	Nickel Caramel Leather / GU24

Square lampshade 7.87" x 5.91" x 3.94"

P-107	Cotton
P-202	White Translucent Ribbon
P-203	Cream Translucent Ribbon

Surface back box 4.33" / Swivel arm

Carlota - G

	120V-60Hz	
	1 x 60 W E26 A15 INC	
	1 x 5 W E26 A15 LED	
	1 x 13 W GU24 T2 CFL	
	1 x 10 W GU24 A15 LED	



1524005U	Satin Nickel
1524006U	Brilliant Chrome
1524060U	Nickel Dark Leather
1524061U	Nickel Caramel Leather
1524005GU	Satin Nickel / GU24
1524006GU	Brilliant Chrome / GU24
1524060GU	Nickel Dark Leather / GU24
1524061GU	Nickel Caramel Leather / GU24

Square lampshade 9.06" x 6.69" x 4.72"

P-487	Cotton
P-486	White Translucent Ribbon
P-489	Cream Translucent Ribbon

Surface back box 4.33" / Swivel arm

Carlota Doble Articulado

	120V-60Hz	
	1 x 60 W E26 A15 INC	
	1 x 5 W E26 A15 LED	
	1 x 13 W GU24 T2 CFL	
	1 x 10 W GU24 A15 LED	



0924005U	Satin Nickel
0924006U	Brilliant Chrome
0924060U	Nickel Dark Leather
0924061U	Nickel Caramel Leather
0924005GU	Satin Nickel / GU24
0924006GU	Brilliant Chrome / GU24
0924060GU	Nickel Dark Leather / GU24
0924061GU	Nickel Caramel Leather / GU24

Square lampshade 9.06" x 6.69" x 4.72"

P-487	Cotton
P-486	White Translucent Ribbon
P-489	Cream Translucent Ribbon

Surface back box 4.33" / Swivel arm

Finishing



Cotton White ribbon Cream ribbon



Satin nickel Brilliant chrome Dark leather Caramel leather

Family

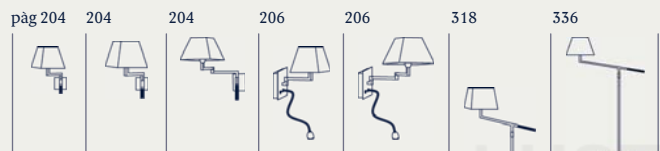

Carlota

by Joana Bover | 2003



Ribbon / Wall Lamp

Carlota - G FL



120V-60Hz



1 x 60 W E26 A15 INC



1 x 5 W E26 A15 LED



1 x 13 W GU24 T2 CFL



1 x 10 W GU24 A15 LED



1 x 1,2 W LED Led: 1,2 W · Optics: 45°
Lumens: 85 lm · CRI: 90
Degrees Kelvin: 2900°

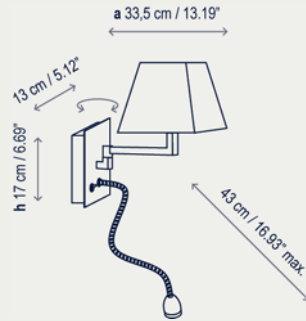

F524005U Satin Nickel
F524006U Brilliant Chrome
F524060U Nickel Dark Leather
F524061U Nickel Caramel Leather

F524005GU Satin Nickel / GU24
F524006GU Brilliant Chrome / GU24
F524060GU Nickel Dark Leather / GU24
F524061GU Nickel Caramel Leather / GU24

Square lampshade 9.06" x 6.69" x 4.72"

P-487 Cotton
P-486 White Translucent Ribbon
P-489 Cream Translucent Ribbon

Surface back box 4.33" x 5.91"

Swivel arm

Flexo made in brass to ensure greater flexibility and rigidity

Carlota - Doble FL



120V-60Hz



1 x 60 W E26 A15 INC



1 x 5 W E26 A15 LED



1 x 13 W GU24 T2 CFL



1 x 10 W GU24 A15 LED



1 x 1,2 W LED Led: 1,2 W · Optics: 45°
Lumens: 85 lm · CRI: 90
Degrees Kelvin: 2900°

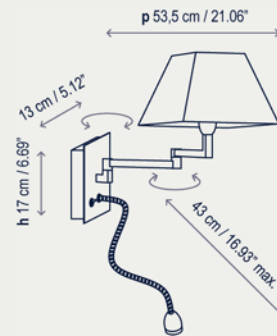

F924005U Satin Nickel
F924006U Brilliant Chrome
F924060U Nickel Dark Leather
F924061U Nickel Caramel Leather

F924005GU Satin Nickel / GU24
F924006GU Brilliant Chrome / GU24
F924060GU Nickel Dark Leather / GU24
F924061GU Nickel Caramel Leather / GU24

Square lampshade 9.06" x 6.69" x 4.72"

P-487 Cotton
P-486 White Translucent Ribbon
P-489 Cream Translucent Ribbon

Surface back box 4.33" x 5.91"

Swivel arm

Flexo made in brass to ensure greater flexibility and rigidity

Family

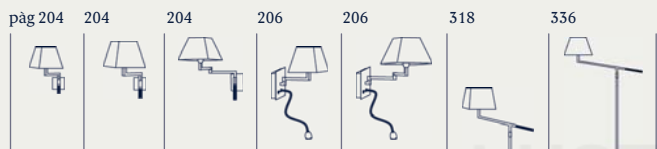

Finishing

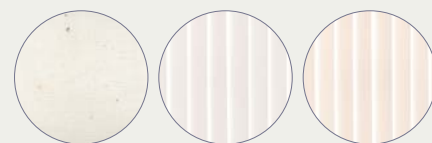

Cotton

White ribbon

Cream ribbon

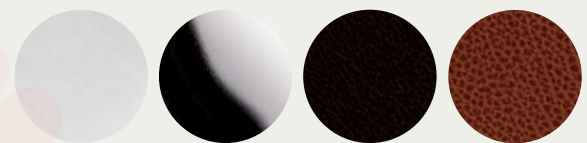

Satin nickel

Brilliant chrome

Dark leather

Caramel leather

Carlota - Doble FL

by Joana Bover | 2003



Ribbon / Wall Lamp

Lexa

-  120V-60Hz 
-  1 x 60 W E26 A15 INC
-  1 x 5 W E26 A15 LED
-  1 x 13 W GU24 T2 CFL
-  1 x 10 W GU24 A15 LED

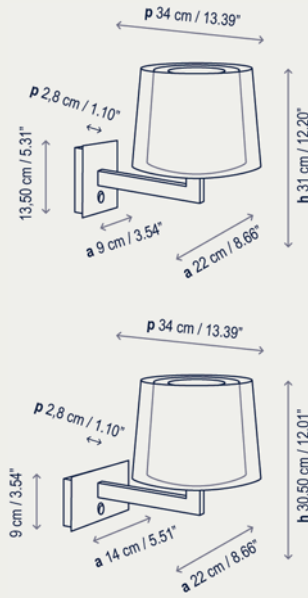

Vertical Backplate-box 3.54" x 5.31"
Surface back box 3" x 6.6"

- 1120505U Satin Nickel
 - 1120506U Brilliant Chrome
 - 1120505GU Satin Nickel / GU24
 - 1120506GU Brilliant Chrome / GU24
- Important note: Must mount vertically 2" x 4"

Horizontal Backplate-box 5.51" x 3.54"
Surface back box 5.8" x 3"

- 1320505U Satin Nickel
 - 1320506U Brilliant Chrome
 - 1320505GU Satin Nickel / GU24
 - 1320506GU Brilliant Chrome / GU24
- Important note: Must mount horizontal 2" x 4"

Outer lampshade 8.66" x 6.30" x 7.09"

- P-633E White Cotton
Cotton shade without upper diffuser
- P-634E White Translucent Ribbon
- P-635E Cream Translucent Ribbon

Set of double lamp shades:

- P-636E* Black Mesh
- P-636I** Black Mesh
- P-637E* Red Mesh
- P-637I** Red Mesh

* Outer lampshade: PVC crystal

** Inner lampshade

Inner shade made of a fire-resistant polyester rigid film



Finishing

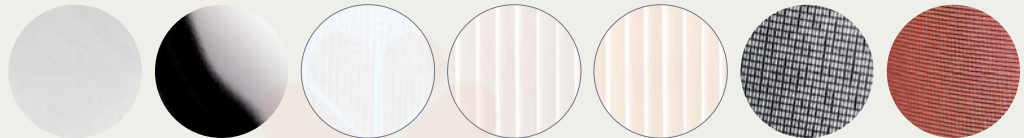

Satin nickel

Brilliant chrome

White cotton

White ribbon

Cream ribbon

Black mesh

Red mesh

Lexa

by Joana Bover | 2008



Ribbon / Wall Lamp

Lexa - FL

120V-60Hz 

1 x 60 W E26 A15 INC

1 x 5 W E26 A15 LED

1 x 15 W GU24 T2 CFL

1 x 10 W GU24 A15 LED

1 x 1,2 W LED | Led: 1,2 W · Optics: 45°
Lumens: 85 lm · CRI: 90
Degrees Kelvin: 2900°

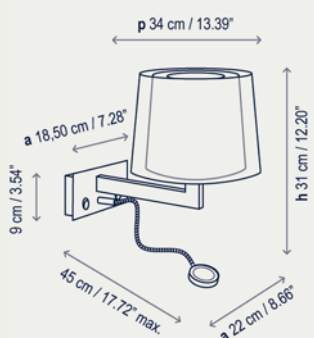
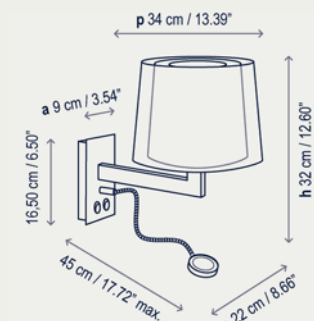

Vertical Backplate-box 3.54" x 6.50"
Surface back box 3" x 6.6"

1220505U Satin Nickel
1220506U Brilliant Chrome
1220505GU Satin Nickel / GU24
1220506GU Brilliant Chrome / GU24

Important Note: Must mount vertically 2" x 4"

Horizontal Backplate-box 7.28" x 3.54"
Surface back box 5.8" x 3"

1020505U Satin Nickel
1020506U Brilliant Chrome
1020505GU Satin Nickel / GU24
1020506GU Brilliant Chrome / GU24

Important note: Must mount horizontal 2" x 4"

Flexo made in brass to ensure greater flexibility and rigidity, with Zamac injection.
Hood and switch on back plate.

Outer lampshade 8.66" x 6.30" x 7.09"
P-633E White Cotton
Cotton shade without upper diffuser

P-634E White Translucent Ribbon
P-635E Cream Translucent Ribbon

Set of double lamp shades:

P-636E* Black Mesh
P-636I** Black Mesh

P-637E* Red Mesh
P-637I** Red Mesh

* Outer lampshade: PVC crystal

** Inner lampshade

Inner shade made of a fire-resistant polyester rigid film



Finishing

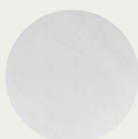

Satin nickel



Brilliant chrome

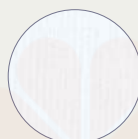

White cotton



White ribbon

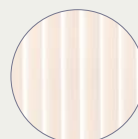

Cream ribbon

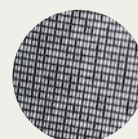

Black mesh

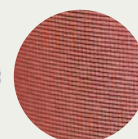

Red mesh

Lexa - FL

by Joana Bover / Christophe Mathieu | 2008



Ribbon / Wall Lamp

Mei Oval - 02

	120V~60Hz	
	1 x 60 W E26 A15 INC	
	1 x 5 W E26 A15 LED	
	1 x 13 W GU24 T2 CFL	
	1 x 10 W GU24 A15 LED	

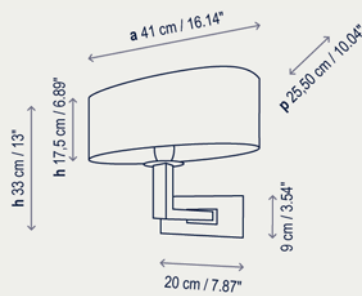

1125005U	Satin Nickel
1125006U	Brilliant Chrome
1125060U	Nickel Dark Leather
1125061U	Nickel Caramel Leather
1125017U	Chrome Black Glass
1125005GU	Satin Nickel / GU24
1125006GU	Brilliant Chrome / GU24
1125060GU	Nickel Dark Leather / GU24
1125061GU	Nickel Caramel Leather / GU24
1125017GU	Chrome Black Glass / GU24

Oval lampshade 16.14" x 6.89" x 5.91" (without diffuser)

P-551	White Translucent Ribbon
P-552	Cream Translucent Ribbon
P-553	Black Translucent Ribbon
P-554	White Cotton

Oval lampshade 16.14" x 6.89" x 5.91" (with diffuser)

P-551D	White Translucent Ribbon
P-552D	Cream Translucent Ribbon
P-553D	Black Translucent Ribbon
P-554D	White Cotton

Shade with upper diffuser can only go with INCANDESCENT bulbs. NOT suitable with compact bulbs.

Standard shade does not include the black glass diffuser.

Surface back box 6.6" x 3"

Important note: Must mount horizontally on 2" x 4" rectangular junction box.

Family



Finishing

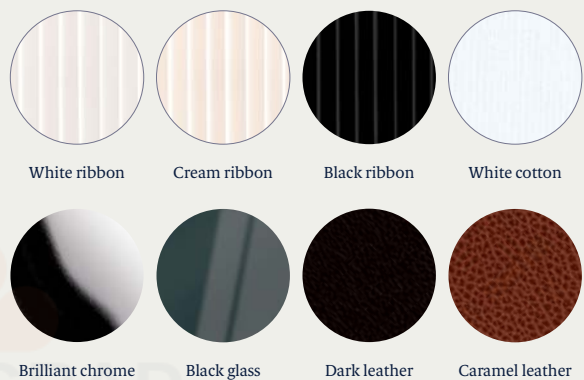

Mei Oval - 02

Design: Joana Bover | 2007





Mei Wall joins the Mei family of pendants, table and floor light. Like the others in the Mei collection, this sconce features clean construction with hardware hidden allowing for options of glass or even leather on the backplate to give a warm sophisticated look. The shades are available in Bover's ribbon options or cotton materials.

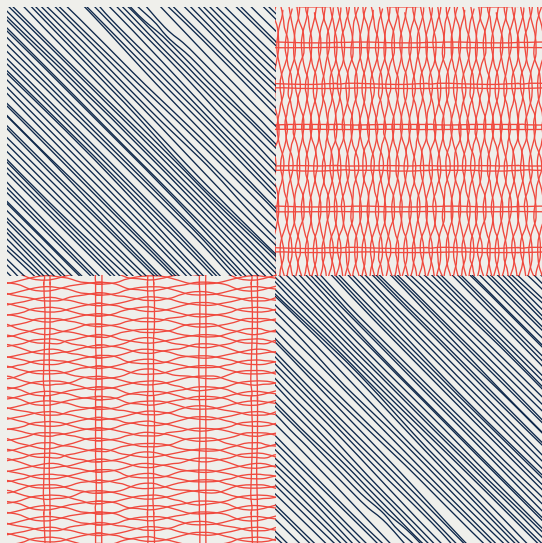



Ribbon / Wall Lamp / Ceiling

Silantra - 03

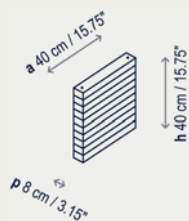

F245529U Polished Aluminium-Cream Translucent Ribbon
F245530U Polished Aluminium-White Translucent Ribbon

Lampshade 15.75" x 15.75"

Not dimmable

Silantra - 04

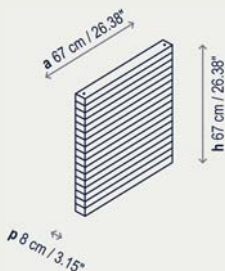
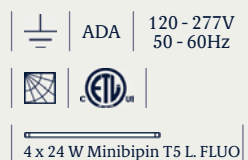

4245531U Cream Translucent Ribbon
4245532U White Translucent Ribbon
D4245531U* Dim 0-10V / Cream Translucent Ribbon
D4245532U* Dim 0-10V / White Translucent Ribbon

* Dimming Ballast (Dim 0-10V)

Polished aluminium
Lampshade 26.38" x 26.38"

Silantra - 05

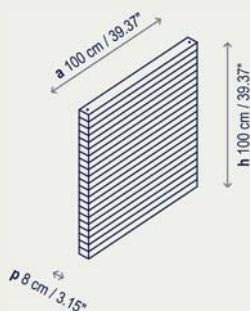
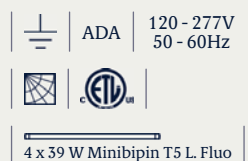

5245533U Cream Translucent Ribbon
5245534U White Translucent Ribbon

D5245533U* Dim 0-10V / Cream Translucent Ribbon
D5245534U* Dim 0-10V / White Translucent Ribbon

* Dimming Ballast (Dim 0-10V)

Polished aluminium
Lampshade 39.37" x 39.37"

Silantra - 06

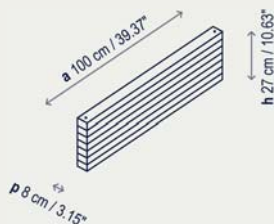
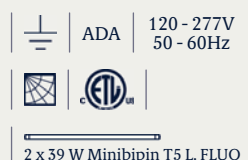

6245535U Cream Translucent Ribbon
6245536U White Translucent Ribbon
D6245535U* Dim 0-10V / Cream Translucent Ribbon
D6245536U* Dim 0-10V / White Translucent Ribbon

* Dimming Ballast (Dim 0-10V)

Polished aluminium
Lampshade 39.37" x 10.63"

Family

pàg 216 216 216 216 280

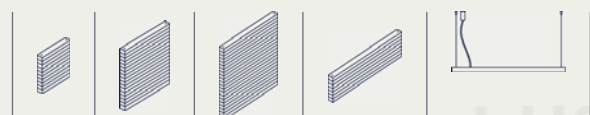

Finishing



Silantra

by Christophe Mathieu | 2004



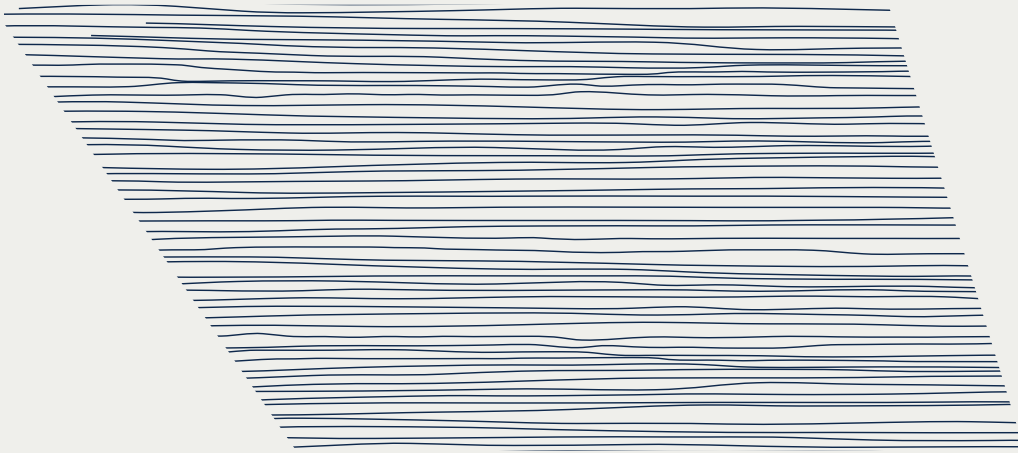

The ceiling, pendant and wall lights of Silantra collection designed by Christophe Mathieu are products meant to improve the illumination in work spaces. The Silantra family has the goal of introducing the ribbon material in the corporate environment, in order to transform the work areas in more comfortable and friendly spaces, where light becomes an essential element for two different reasons: Offer a good light with a high efficiency. Making the work area become a more warm and pleasant place. Make the working areas become a more warm and pleasant place.

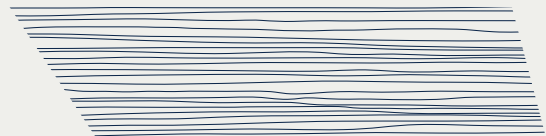





DESIGN PLUS

SILANTRA COLLECTION
AWARDED WITH DESIGN PLUS
PRIZE(L+B, FRANKFURT)2006.



Christophe Mathieu



Ribbon / Wall Lamp

Wall Street - FL

120V-60Hz 

1 x 60 W E26 A15 INC

1 x 5 W E26 A15 LED

1 x 13 W GU24 T2 CFL

1 x 10 W GU24 A15 LED

1 x 1,2 W LED | Led: 1,2 W · Optics: 45°
Lumens: 85 lm · CRI: 90
Degrees Kelvin: 2900°

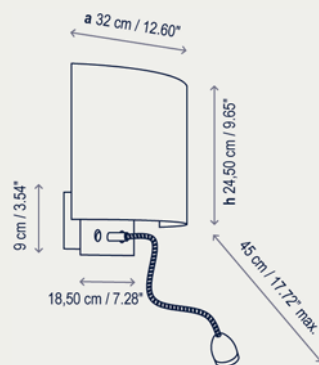

1118505FLU	Satin Nickel
1118506FLU	Brilliant Chrome
1118505FLGU	Satin Nickel / GU24
1118506FLGU	Brilliant Chrome / Gu24

Lampshade 12.60" x 7.87"

P-339	Cotton
P-332	White Cotton
P-333	Cream Translucent Ribbon
P-334	White Translucent Ribbon

Surface back box: 6.6" x 3"

Flexo made in brass to ensure greater flexibility and rigidity

Finishing



Satin nickel

Brilliant chrome

Cotton

White cotton

Cream ribbon

White ribbon

Wall Street - FL

by Joana Bover | 2010



Ribbon / Wall Lamp

Wall Street

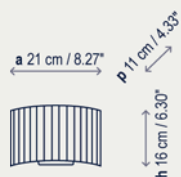
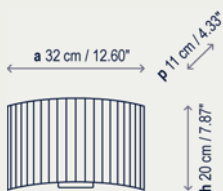
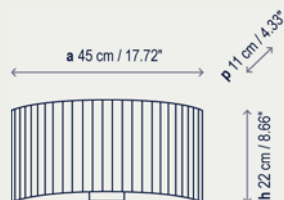

- 1118505U Satin Nickel
- 1118504U Black Iron
- 1118503U Graphite Brown Iron
- 1118505GU Satin Nickel / GU24
- 1118504GU Black Iron / GU24
- 1118503GU Graphite Brown Iron / GU24

Surface back box 4.52" x 4.52"
On request can be produced with ADA compliance

Lampshade 17.72" x 8.66"

- P-296 Cotton
- P-297 White Cotton
- P-298 Cream Translucent Ribbon
- P-299 White Translucent Ribbon

Lampshade 12.60" x 7.87"

- P-339 Cotton
- P-332 White Cotton
- P-333 Cream Translucent Ribbon
- P-334 White Translucent Ribbon

Lampshade 8.27" x 6.30"

- P-347 Cotton
- P-342 White Cotton
- P-355 Cream Translucent Ribbon
- P-356 White Translucent Ribbon

Finishing



Satin nickel

Black iron

Brown iron

Cotton

White cotton

Cream ribbon

White ribbon

Wall Street

by Joana Bover | 2000

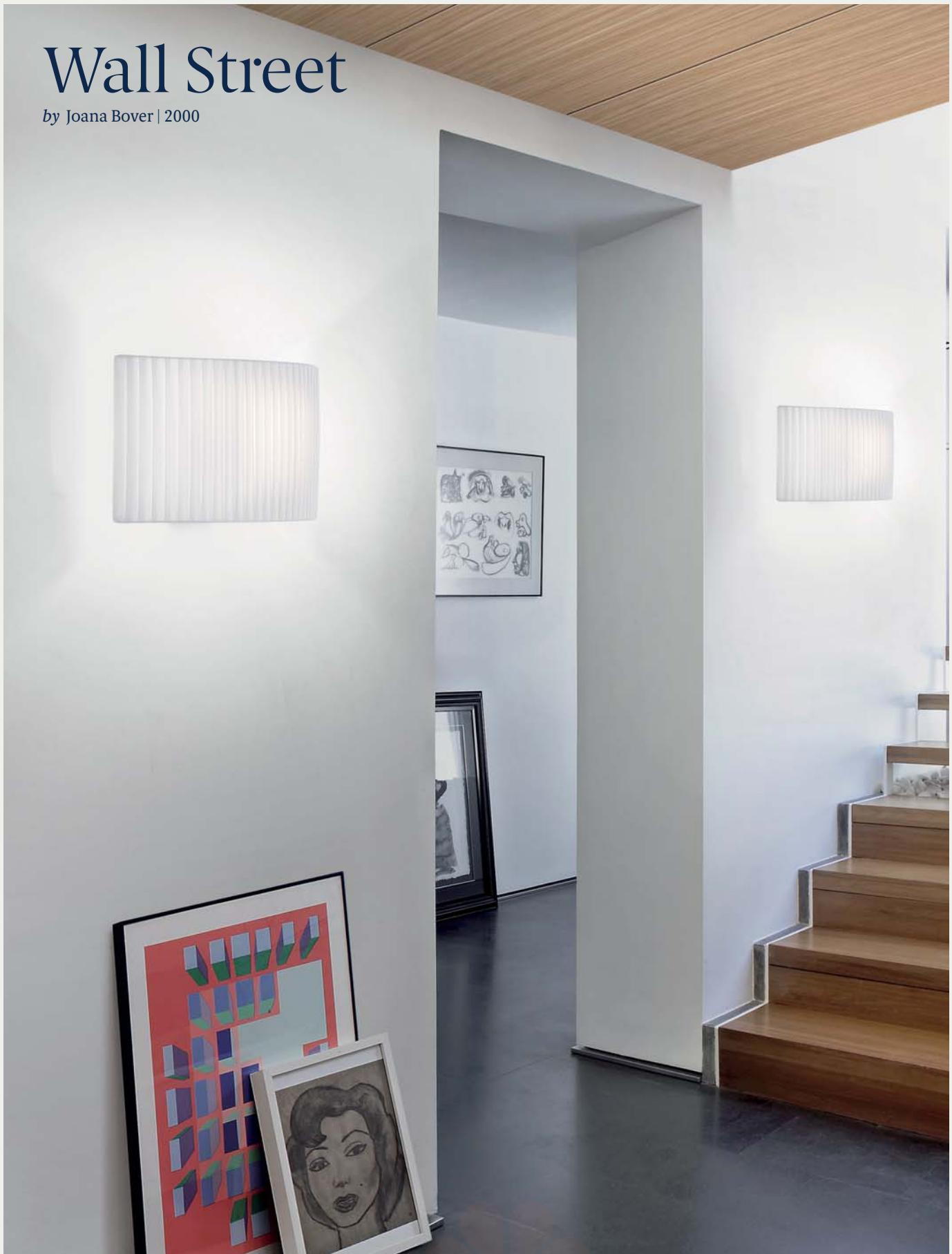

Ribbon / Wall Lamp

Wall Street T5 - 01

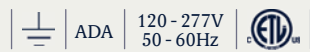

2 x 24 W Minibipin T5 L. FLUO

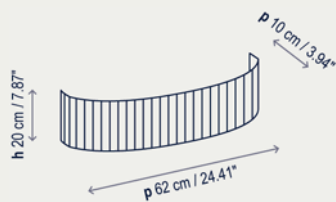

T529001U White Structure T-5/01
DT529001U* Dim 0-10V / White Structure T-5/01

* Dimming Ballast (Dim 0-10V)

Lampshade T-5/01

P-605 White Cotton
P-606 White Translucent Ribbon
P-607 Cream Translucent Ribbon

Wall lamp measures are according to T-5 HO Fluorescents

Wall Street T5 - 02

Big Format

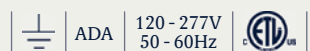

2 x 39 W Minibipin T5 L. FLUO

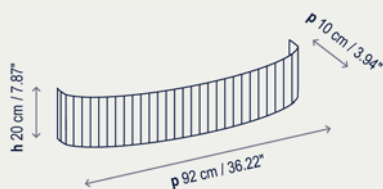

T529002U White Structure T-5/02
DT529002U* Dim 0-10V / White Structure T-5/02

* Dimming Ballast (Dim 0-10V)

Lampshade T-5/02

P-611 White Cotton
P-612 White Translucent Ribbon
P-613 Cream Translucent Ribbon

Wall lamp measures are according to T-5 HO Fluorescents



Finishing

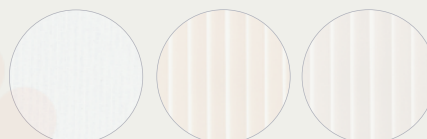

White cotton

Cream ribbon

White ribbon

Wall Street T5





by Joana Bover | 2008



Ribbon / Pendant Lamp

Cornelia - 02

Big Format

-  120V-60Hz
-   8 x 14 W E26 Triple CFL
-  8 x 5 W E26 A15 LED

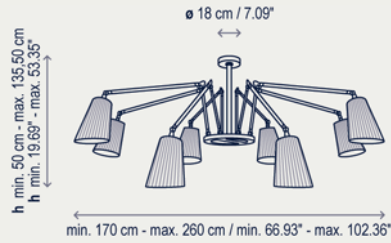

- 2620210041U White - Polished Brass
- 2620210044U White - Chrome
- 2620210045U Black - Polished Brass
- 2620210042U Black - Chrome





Cone-shaped shades 7.28" x 10.43" x 3.94"

- P-776 White Translucent Ribbon
- P-777 Cream Translucent Ribbon
- P-781 Red Translucent Ribbon
- P-782 White Cotton
- P-778 Black Cotton
- P-779 White Fabric - Orange Inside
- P-780 Black Fabric - Orange Inside
- P-783 Black Fabric - Gold Inside
- P-784 Black Fabric - Silver Inside

Diffusers are included on the price of the luminaire structure
Black/red fitting includes black diffuser
White fitting includes white diffuser

Cornelia - 03

Big Format

-  120V-60Hz
-   12 x 14 W E26 Triple CFL
-  12 x 5 W E26 A15 LED

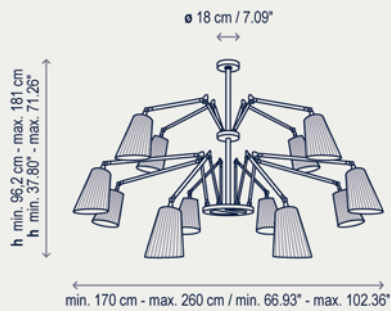

- 2620310041U White - Polished Brass
- 2620310044U White - Chrome
- 2620310045U Black - Polished Brass
- 2620310042U Black - Chrome

Cone-shaped shades 7.28" x 10.43" x 3.94"

- P-776 White Translucent Ribbon
- P-777 Cream Translucent Ribbon
- P-781 Red Translucent Ribbon
- P-782 White Cotton
- P-778 Black Cotton
- P-779 White Fabric - Orange Inside
- P-780 Black Fabric - Orange Inside
- P-783 Black Fabric - Gold Inside
- P-784 Black Fabric - Silver Inside

Diffusers are included on the price of the luminaire structure
Black/red fitting includes black diffuser
White fitting includes white diffuser

Finishing

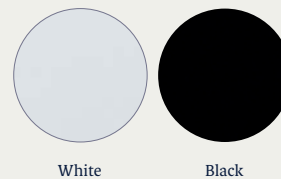

White

Black

Finishing

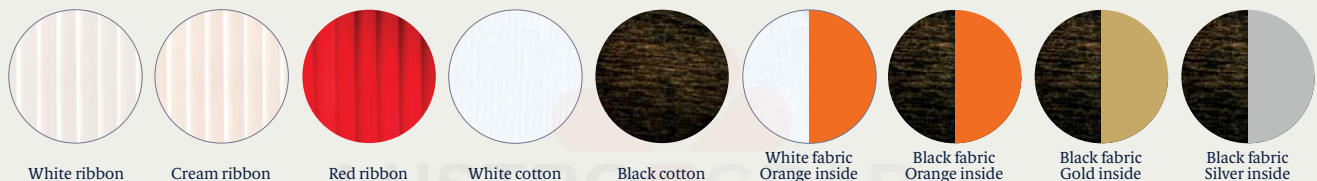

White ribbon

Cream ribbon

Red ribbon

White cotton

Black cotton

White fabric Orange inside

Black fabric Orange inside

Black fabric Gold inside

Black fabric Silver inside

Cornelia

by Joana Bover | 2013



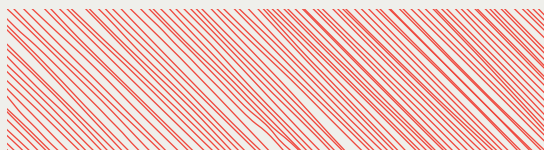

CORNELIA, an intense and continuing bet on Bover's characteristic Big Formats. It is an exuberant light following Scandinavian design guidelines resulting in a luminaire full of light nuances and a strong artistic expression. Cornelia is far from those conventional designs offered with classic chandeliers and shows a more contemporaneous and even industrial look. Regardless of the place Cornelia is installed, it gets a remarkable appearance thanks to its adjustable arms and the possibility of angling its shades as desired. Cornelia's format enables us to create an almost à la carte Custom Product. Cornelia consists of 36 joints made out of brass which function is permitting different final positions of the arms. The shades have an inner independent reflector and are customizable are not showing the common radius which are usually visible on the shades. Another interesting feature of the diffuser is its mobility, easy maintenance and light source replacement. The central shaft of Cornelia may be modified on project specification, depending on the height and installation conditions.



Custom product: "Shown here is custom length" | Tarambana / Espai Gastronòmic / Cardedeu





Ribbon / Pendant Lamp

Danona - 1 L

-  120V-60Hz 
-  1 x 100 W E26 A19 INC
-  1 x 10 W E26 A19 LED
-  1 x 18 W GU24 T2 CFL
-  1 x 12 W GU24 A19 LED

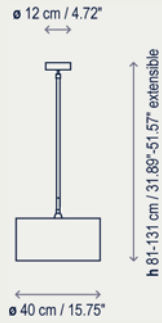

- 4123105U Satin Nickel
- 4123160U Nickel Dark Leather
- 4123161U Nickel Caramel Leather
- 4123105GU Satin Nickel / GU24
- 4123160GU Nickel Dark Leather / GU24
- 4123161GU Nickel Caramel Leather / GU24

Lampshade 15.75" x 8.66" x 15.75"

- P-416U Cotton
- P-420U White Translucent Ribbon
- P-421U Cream Translucent Ribbon

The shade includes upper diffuser

Danona - 3 L

-  120V-60Hz 
-  3 x 100 W E26 A19 INC
-  3 x 10 W E26 A19 LED
-  3 x 18 W GU24 T2 CFL
-  3 x 12 W GU24 A19 LED

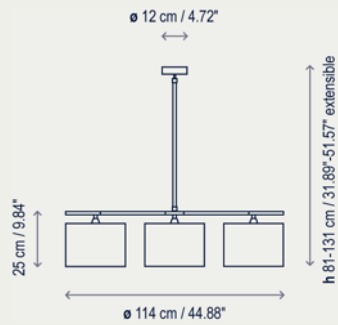

- 4323105U Satin Nickel
- 4323160U Nickel Dark Leather
- 4323161U Nickel Caramel Leather
- 4323105GU Satin Nickel / GU24
- 4323160GU Nickel Dark Leather / GU24
- 4323161GU Nickel Caramel Leather / GU24

Lampshade 10.63" x 7.09" x 10.63" Unitary price

- P-150 Cotton
- P-005C Cream Translucent Ribbon
- P-006C White Translucent Ribbon

*Extensions have a standard length of 23.62"



Family

påg 234 234 324 324 338

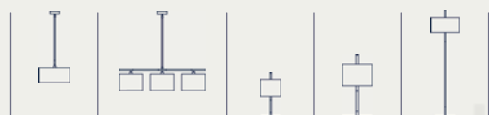

Finishing



Danona

Design: Joana Bover | 2002



Ribbon / Pendant Lamp

Lámpara XVIII

120V-60Hz 

18 x 60 W E26 A15 INC

18 x 5 W E26 A15 LED

18 x 13 W GU24 T2 CFL

18 x 10 W GU24 A15 LED

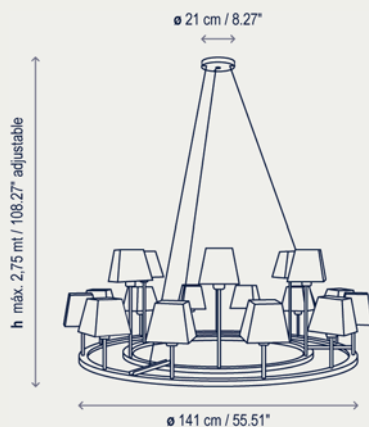

- 4610306U Grey Silver-Chrome
- 4610304U Graphite Brown-Nickel
- 4610306GU Grey Silver-Chrome / GU24
- 4610304GU Graphite Brown-Nickel / GU24

With 2 lighting-mood positions
Adjustable height
For easier installation, available with tensor wires including interior ball-and-socket joints
Silver wire

Square lampshades 5.91" x 5.12" x 3.94"

- P-640 White Cotton
- P-641 White Translucent Ribbon
- P-642 Cream Translucent Ribbon
- P-643 Red Translucent Ribbon

Cone-shaped shades 7.09" x 5.91" x 4.72"

- P-750 Cotton
- P-751 White Translucent Ribbon
- P-752 Cream Translucent Ribbon
- P-753 Red Translucent Ribbon



Finishing



Lámpara XVIII

by Joana Bover | 1998







Ribbon / Pendant Lamp

Lua - 1 L

- 120V-60Hz 
- 2 x 100 W E26 A19 INC 
- 2 x 10 W E26 A19 LED 
- 2 x 14 W E26 TRIPLE CFL 

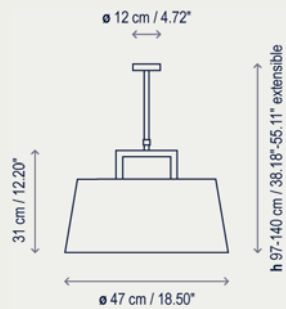



- 4122904U Black Iron
- 4122905U Satin Nickel
- 4122960U Nickel Dark Leather
- 4122961U Nickel Caramel Leather

Lampshade 18.50" x 8.27" x 15.75"

- P-160CU Cotton
- P-183CU Cream Translucent Ribbon
- P-184CU White Translucent Ribbon

The shade includes upper diffuser

Lua - 2 L

- 120V-60Hz 
- 2 x 100 W E26 A19 INC 
- 2 x 10 W E26 A19 LED 
- 2 x 14 W E26 TRIPLE CFL 

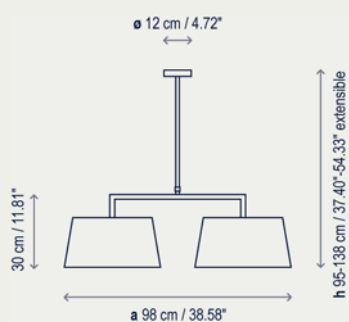

- 4222904U Black Iron
- 4222905U Satin Nickel
- 4222960U Nickel Dark Leather
- 4222961U Nickel Caramel Leather

Lampshade 14.96" x 7.87" x 11.81"

- P-163CU Cotton
- P-167CU Cream Translucent Ribbon
- P-168CU White Translucent Ribbon

The shade includes upper diffuser



Finishing



Black iron

Satin nickel

Dark leather

Caramel leather

Cotton

Cream ribbon

White ribbon

Lua

by Joana Bover | 2002



Ribbon / Pendant Lamp

Mar

- 120V-60Hz 
- 3 x 60 W E26 A15 INC
- 3 x 5 W E26 A15 LED
- 3 x 13 W GU24 T2 CFL
- 3 x 10 W GU24 A15 LED

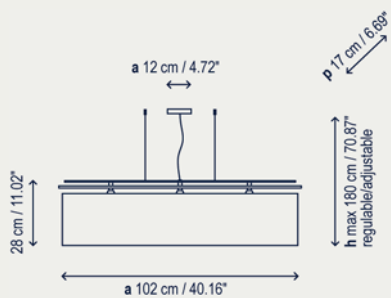

- 4324405TU Nickel Transparent Wire
- 4324405RU Nickel Red Wire
- 4324460U Dark Leather Transparent Wire
- 4324461U Caramel Leather Transparent Wire
- 4324405TGU Nickel Transparent Wire / GU24
- 4324405RGU Nickel Red Wire / GU24
- 4324460GU Dark Leather Transparent Wire / GU24
- 4324461GU Caramel Leather Transparent Wire / GU24

Rectangular lampshade 39.37" x 6.69". Diffuser included

- P-521 Cream Translucent Ribbon
- P-522 White Translucent Ribbon
- P-523 Red Translucent Ribbon
- P-524 Cotton



Finishing



Mar

by Joana Bover | 2004

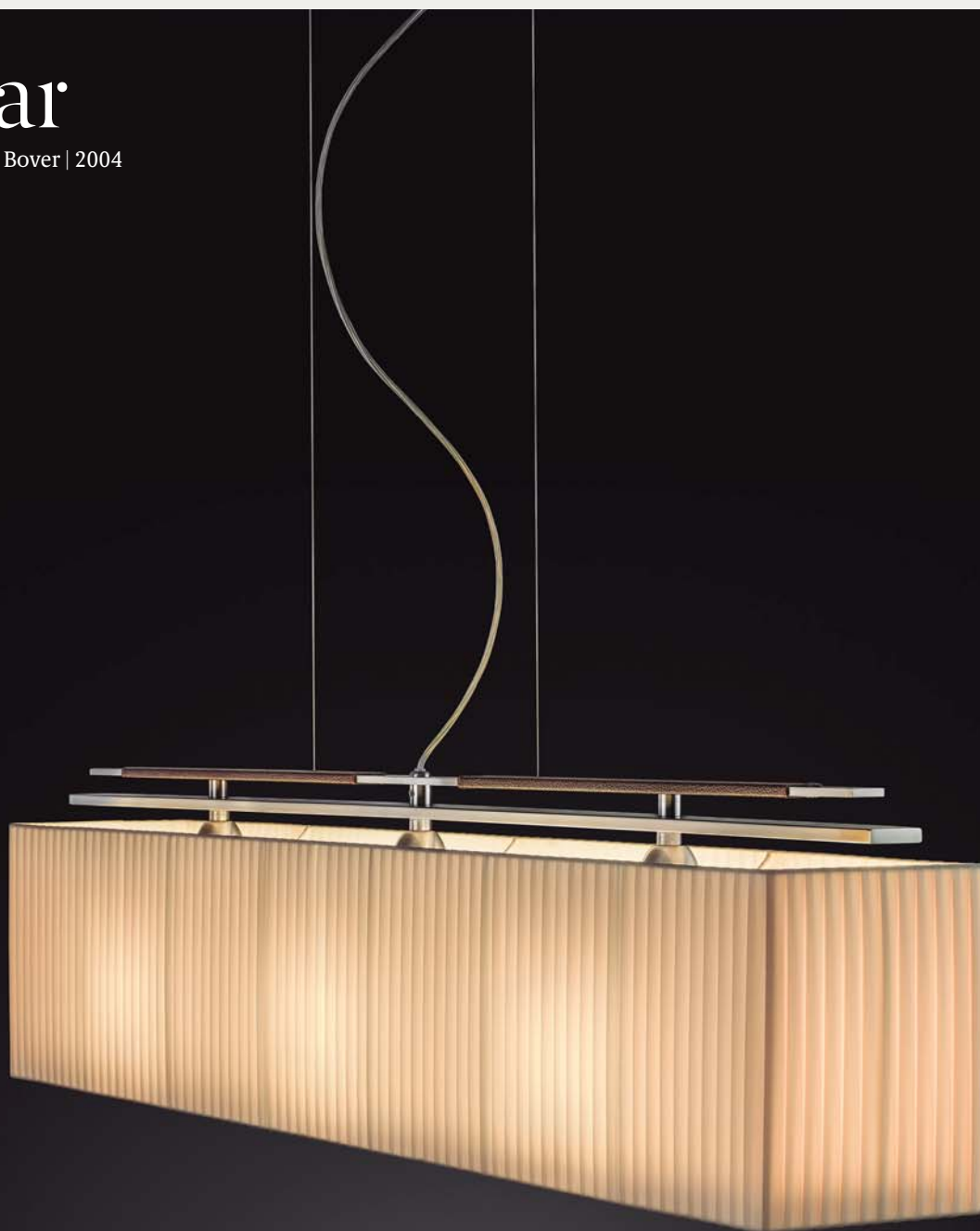

Ribbon / Pendant Lamp

Marietta - 90

Big Format

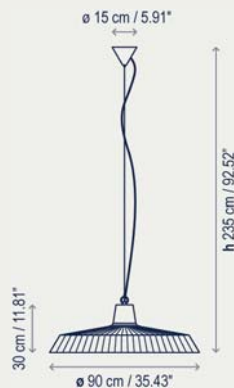
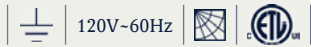

3310220262U Satin Aluminum
3310220289U Satin Copper

P-785 White Translucent Ribbon
P-786 Cream Translucent Ribbon
P-787 Red Translucent Ribbon
P-826 Black Translucent Ribbon

Opal polycarbonate diffuser
Adjustable tensor wire

Please consult for custom options

Big Format

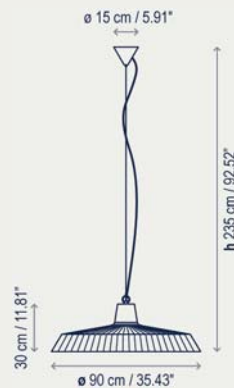

3310221062U Led Dim 0-10V Satin Aluminum
3310221089U Led Dim 0-10V Satin Copper



Finishing



Satin aluminum

Satin copper

White ribbon

Cream ribbon

Red ribbon

Black ribbon

Marietta

by Joana Bover | 2015





MARIETTA is an outstanding interpretation of the classical industrial lights installed in most of the warehouses and factories in Europe during the beginning of the Twentieth Century. In Bover we took the decision of going through this classical and functional lighting model and make it into a warm, contemporary and decorative object, which is able to adapt to any environment and live together with other products more purist and with less presence. After studying it, we decided to keep the aluminum cone as the original one used also with the metal

ring, showing discreetly the nature of the luminaire. The handmade ribbon shades make this piece special and unique. MARIETTA collection consists of Big Format lights designed both for corporate and commercial spaces, for the restaurant industry and indoor spaces. MARIETTA includes a polycarbonate bottom diffuser and is available in dimmable version.



Ribbon / Pendant Lamp

Marietta - 120

Big Format



120V-60Hz



5 x 14 W E26 TRIPLE CFL



5 x 5 W E26 A15 LED

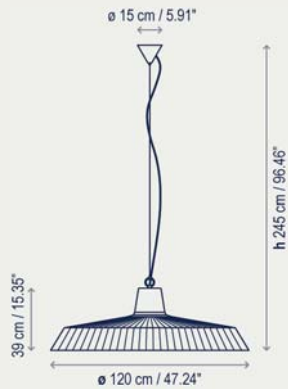

3310320262U Satin Aluminum
3310320289U Satin Copper

P-788 White Translucent Ribbon
P-789 Cream Translucent Ribbon
P-800 Red Translucent Ribbon
P-827 Black Translucent Ribbon

Opal polycarbonate diffuser
Adjustable tensor wire

Please consult for custom options

Big Format



120 - 277V
50 - 60Hz



39 W LED Led 108 x 0,36 W = 39 W
Lumens 4381 lm · CRI 90
Degrees Kelvin 2700º

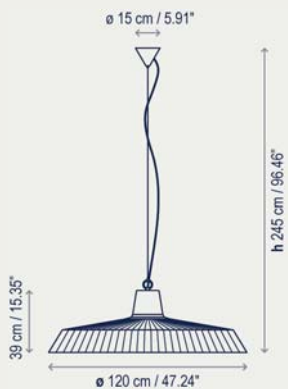

3310321062U Led Dim 0-10V Satin Aluminum
3310321089U Led Dim 0-10V Satin Copper



Finishing



Satin aluminum

Satin copper

White ribbon

Cream ribbon

Red ribbon

Black ribbon

Marietta

Design: Joana Bover | 2015



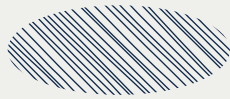
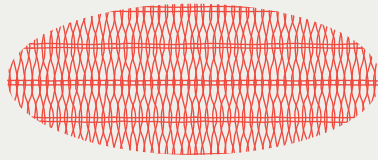



Ribbon / Pendant Lamp

Maxi - 01

-  120V-60Hz 
-  4 x 60 W E26 A15 INC
-  4 x 5 W E26 A15 LED
-  4 x 13 W GU24 T2 CFL
-  4 x 10 W GU24 A15 LED

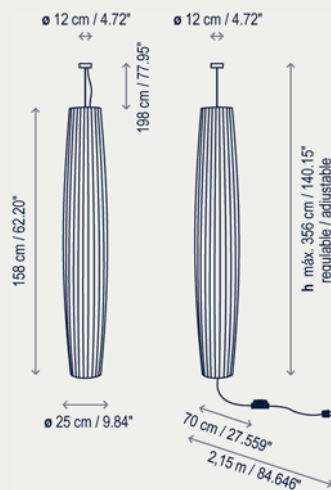

- 43195TOPU Electrical Upper Installation
- 4319505U Electrical Bottom Installation
- 43195TOPGU Electrical Upper Installation / GU24
- 4319505GU Electrical Bottom Installation / GU24

Lampshade 62.20" X 9.84"

- P-507TU Top Cream Ribbon
- P-508TU Top White Ribbon
- P-507IU Bottom Inst. Cream Ribbon
- P-508IU Bottom Inst. White Ribbon

- P-507TGU Top Cream Ribbon / GU24
- P-508TGU Top White Ribbon / GU24
- P-507IGU Bottom Inst. Cream Ribbon / GU24
- P-508IGU Bottom Inst. White Ribbon / GU24

Adjustable Tensor Wire
Nickel Canopy (Only for upper installation)

Maxi 01 / Maxi 02 Pendant lamp comes in two versions:
With upper installation and with bottom installation.

Maxi - 02

-  120V-60Hz 
-  4 x 60 W E26 A15 INC
-  4 x 5 W E26 A15 LED
-  4 x 13 W GU24 T2 CFL
-  4 x 10 W GU24 A15 LED

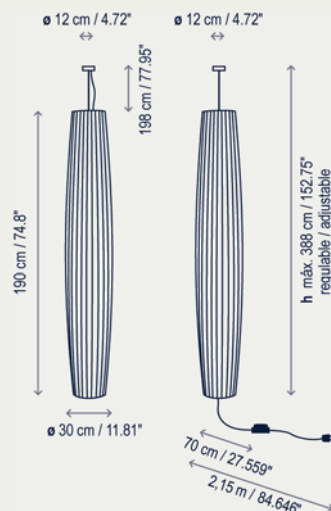

- 44195TOPU Electrical Upper Installation
- 4419505U Electrical Bottom Installation
- 44195TOPGU Electrical Upper Installation / GU24
- 4419505GU Electrical Bottom Installation / GU24

Lampshade 74.80" X 11.81"

- P-506TU Top Cream Ribbon
- P-509TU Top White Ribbon
- P-506IU Bottom Inst. Cream Ribbon
- P-509IU Bottom Inst. White Ribbon

- P-506TGU Top Cream Ribbon / GU24
- P-509TGU Top White Ribbon / GU24
- P-506IGU Bottom Inst. Cream Ribbon / GU24
- P-509IGU Bottom Inst. White Ribbon / GU24

Adjustable Tensor Wire
Nickel Canopy (Only for upper installation)

Maxi 01 / Maxi 02 Pendant lamp comes in two versions:
With upper installation and with bottom installation.

Family

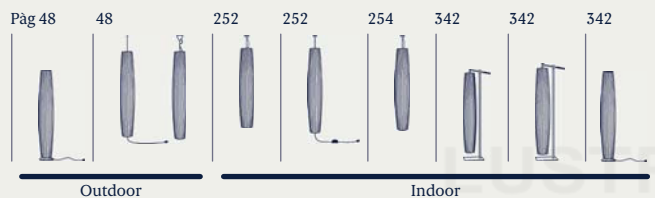

Finishing

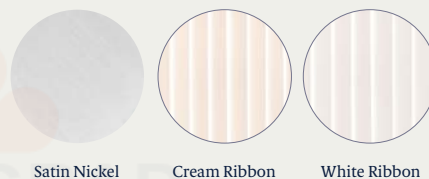

Satin Nickel

Cream Ribbon

White Ribbon

Maxi

by Joana Bover | 2004



Ribbon / Pendant Lamp

Maxi - 03 / Dimable

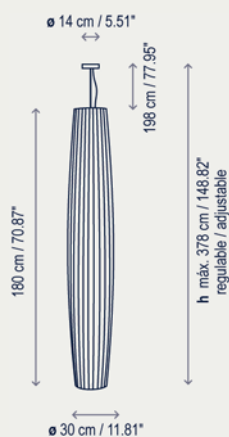
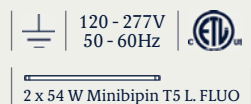

4303195TOPU Electrical Upper Installation

Dimming Ballast (Dim 0-10V)

Lampshade 70.87" x 11.81"

P-754TU Top Cream Ribbon

P-755TU Top White Ribbon

Adjustable tensor wire

Nickel canopy

Supply fluorescent tubes already installed inside the luminaire.

Family

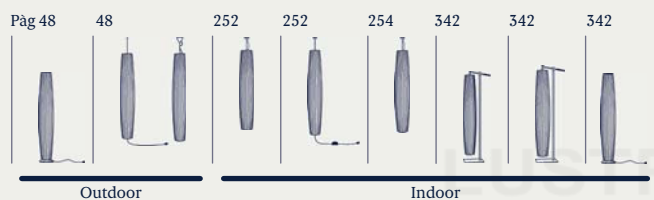

Finishing



Satin Nickel

Cream Ribbon

White Ribbon



Custom product



S.T. OR Lighting / Israel

MAXI represents for sure the most characteristic and emblematic product of BOVER. Made out of translucent ribbon since its creation in 2001, Maxi has achieved positioning itself as one of the most reliable and best seller product in BOVER's catalogue, regardless the market or culture it is addressed to. Maxi meets in one product BOVER's essence: its smooth shapes, its warm light and the different available options. It presents to the market a non-temporal offering, adapting itself without fussiness to any environment without losing its contemporary aspect.





Ribbon / Pendant Lamp

Mei - 38

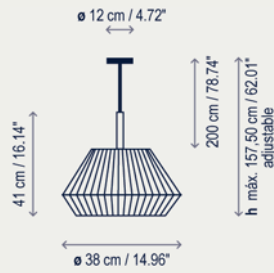

- 4219903U Brown Iron
- 4219904U Black Iron
- 4219905U Satin Nickel

Lampshade 12.60" x 7.48" x 7.87"

- P-495C Red Translucent Ribbon
- P-504C Cream Translucent Ribbon
- P-505C White Translucent Ribbon

Diffuser included
Transparent connection

Mei - 60

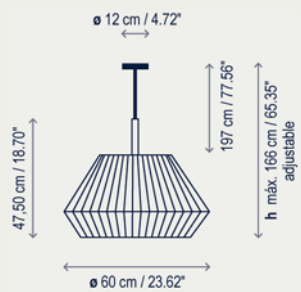

- 4119903U Brown Iron
- 4119904U Black Iron
- 4119905U Satin Nickel

Lampshade 19.69" x 12.20" x 11.81"

- P-496C Black Translucent Ribbon
- P-501C Red Translucent Ribbon
- P-502C Cream Translucent Ribbon
- P-503C White Translucent Ribbon

Diffuser included
Transparent connection

Mei - 90 Big Format

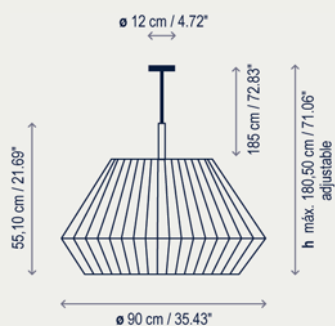

- 4419903U Brown Iron
- 4419904U Black Iron
- 4419905U Satin Nickel

Lampshade 31.50" x 16.34" x 13.78"

- P-490C White Translucent Ribbon
- P-491C Cream Translucent Ribbon
- P-492C Red Translucent Ribbon
- P-493C Black Translucent Ribbon

Diffuser included
Transparent connection

Family

pàg 258 258 258 260 260

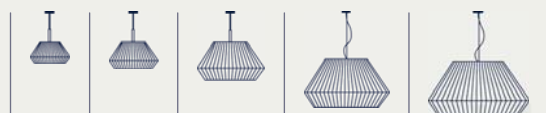

Finishing



White ribbon Cream ribbon Red ribbon Black ribbon



Brown iron Black iron Satin nickel





Mei

by Joana Bover | 2004



Ribbon / Pendant Lamp

Mei - 125 Big Format

-  120V-60Hz 
-  5 x 100 W E26 A19 INC
-  5 x 10 W E26 A19 LED
-  5 x 20 W E26 TRIPLE CFL

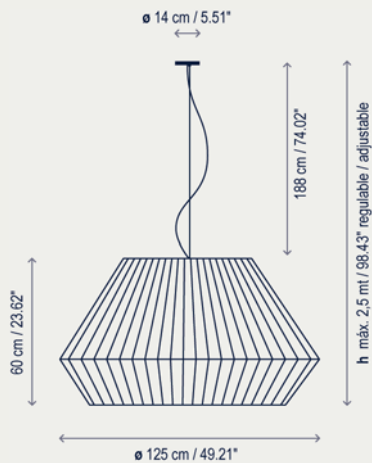



- 4719903U Brown Iron
- 4719904U Black Iron
- 4719905U Satin Nickel

Lampshade 49.21" x 23.62" x 18.90"

- P-720C White Translucent Ribbon
- P-721C Cream Translucent Ribbon
- P-722C Red Translucent Ribbon
- P-723C Black Translucent Ribbon

Diffuser included
Transparent connection

Mei - 150 Big Format

-  120V-60Hz 
-  6 x 100 W E26 A19 INC
-  6 x 10 W E26 A19 LED
-  6 x 20 W E26 TRIPLE CFL

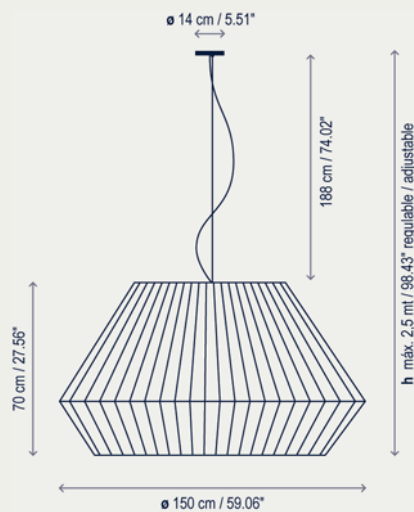

- 4619903U Brown Iron
- 4619904U Black Iron
- 4619905U Satin Nickel

Lampshade 59.06" x 27.56" x 23.23"
Diffuser included

- P-590C White Translucent Ribbon
- P-591C Cream Translucent Ribbon
- P-592C Red Translucent Ribbon
- P-593C Black Translucent Ribbon

Transparent connection
Porcelain lampholders

Family

pàg 258 258 258 260 260

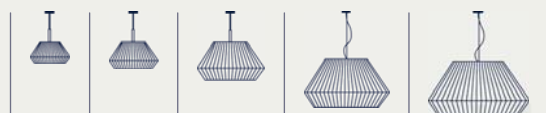

Finishing



White ribbon Cream ribbon Red ribbon Black ribbon

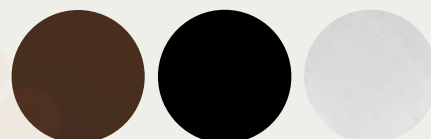

Brown iron Black iron Satin nickel



Ribbon / Pendant Lamp

Mei - 100

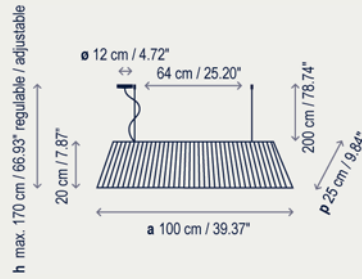

- 4319903U Brown Iron
- 4319904U Black Iron
- 4319905U Satin Nickel
- 4319903GU Brown Iron / GU24
- 4319904GU Black Iron / GU24
- 4319905GU Satin Nickel / GU24

Rectangular lampshade 39.37" x 9.84"

- P-497C Cream Translucent Ribbon
- P-498C Cotton
- P-499C Linen
- P-584C White Translucent Ribbon
- P-585C Red Translucent Ribbon
- P-586C Black Translucent Ribbon

Diffuser included
Adjustable tensor wire

Mei - 120

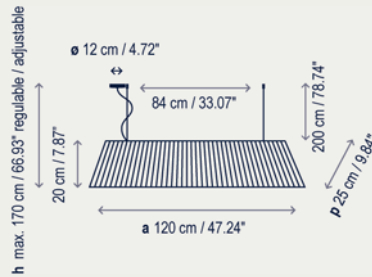

- 4519903U Brown Iron
- 4519904U Black Iron
- 4519905U Satin Nickel
- 4519903GU Brown Iron / GU24
- 4519904GU Black Iron / GU24
- 4519905GU Satin Nickel / GU24

Rectangular lampshade 47.24" x 9.84"
Diffuser included

- P-510C Cream Translucent Ribbon
- P-511C Cotton
- P-512C Linen
- P-514C White Translucent Ribbon
- P-522C Red Translucent Ribbon
- P-523C Black Translucent Ribbon

Adjustable tensor wire

Mei - 180 Big Format

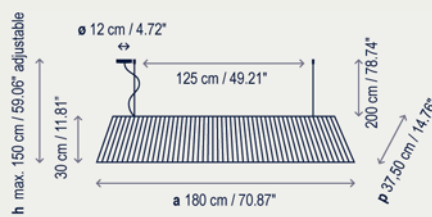
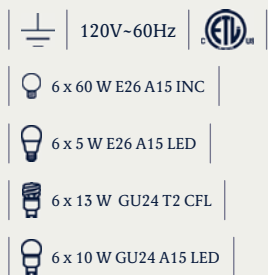

- 430319903U Brown Iron
- 430319904U Black Iron
- 430319905U Satin Nickel
- 430319903GU Brown Iron / GU24
- 430319904GU Black Iron / GU24
- 430319905GU Satin Nickel / GU24

Rectangular lampshade 70.87" x 14.76"
Diffuser included

- P-756C Cream Translucent Ribbon
- P-757C Cotton
- P-758C Linen
- P-759C White Translucent Ribbon
- P-760C Red Translucent Ribbon
- P-761C Black Translucent Ribbon

Adjustable tensor wire

Finishing

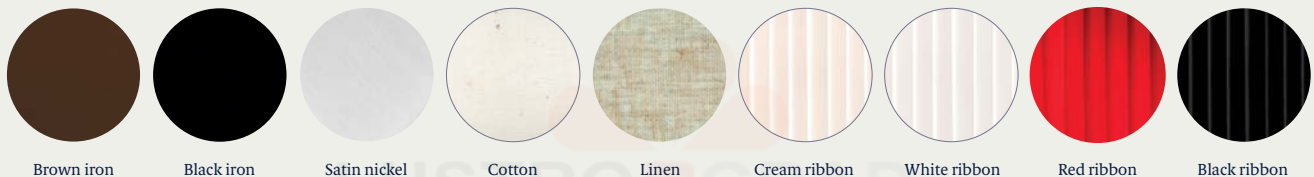

Mei

Design: Joana Bover | 2004





Mei is a pendant family composed of different shapes and lines but with a common denominator: the ribbon. The ribbon shades are entirely made in BOVER, starting with the frames welding to the ribbon process itself. This allows us to totally control the product quality, custom process and delivery terms. The Mei lamps are great for environments where a warm light is required. They mostly have a wide diameter, offering as a result a good direct light. Discrete and decorative since its mechanical structure is hidden inside the lamp, as if they were in a second place. Lamps are held by thin tensor wires that enhance its lightness. With Mei collection we have developed tailor-made lamps with important dimensions, and we have been able to make a quality packaging to ensure the shipment worldwide.



Ribbon / Pendant Lamp

Mei Oval

	120V~60Hz	
	3 x 60 W E26 A15 INC	
	3 x 5 W E26 A15 LED	
	3 x 14 W E26 TRIPLE CFL	

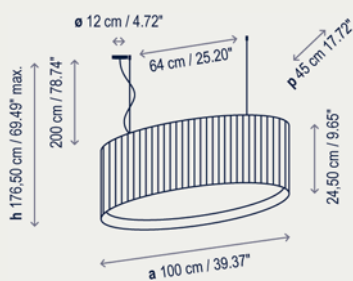

4319903U	Brown Iron
4319904U	Black Iron
4319905U	Satin Nickel

Oval lampshade 39.37" x 9.65" x 17.32"
PVC diffuser included

P-545C	White Translucent Ribbon
P-546C	Cream Translucent Ribbon
P-547C	Black Translucent Ribbon
P-548C	White Cotton

Adjustable tensor wire



Family

pàg 212 266 330 330 330 344



Finishing

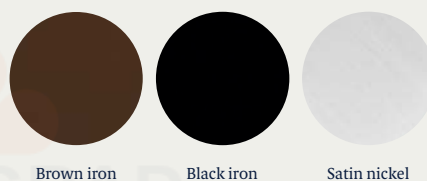
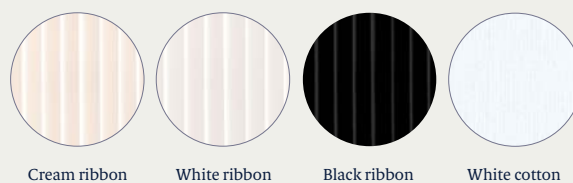





Mei Oval

by Joana Bover | 2006



Ribbon / Pendant Lamp

Mos - 01

- 120V~60Hz 
- 3 x 60 W E26 A15 INC 
- 3 x 5 W E26 A15 LED 
- 3 x 14 W E26 TRIPLE CFL 

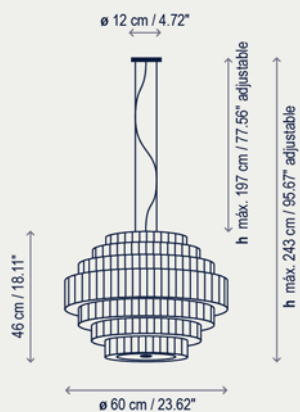

- 224P617U White Translucent Ribbon
- 224P618U Cream Translucent Ribbon
- 224P619U Red Translucent Ribbon

White opal glass diffuser included
Satin nickel
Transparent connection
Adjustable tensor wire
Safety tensor wire

Mos - 02

- 120V~60Hz 
- 5 x 60 W E26 A15 INC 
- 5 x 5 W E26 A15 LED 
- 5 x 14 W E26 TRIPLE CFL 

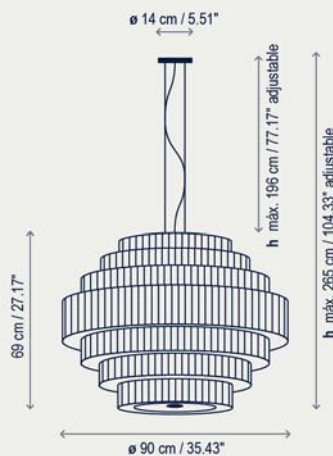

- 224P622U White Translucent Ribbon
- 224P623U Cream Translucent Ribbon
- 224P624U Red Translucent Ribbon

White opal glass diffuser included
Satin nickel
Transparent connection
Adjustable tensor wire
Safety tensor wire

Mos - 03 Big Format

- 120V~60Hz 
- 6 x 100 W E26 A19 INC 
- 6 x 10 W E26 A19 LED 
- 6 x 20 W E26 TRIPLE CFL 

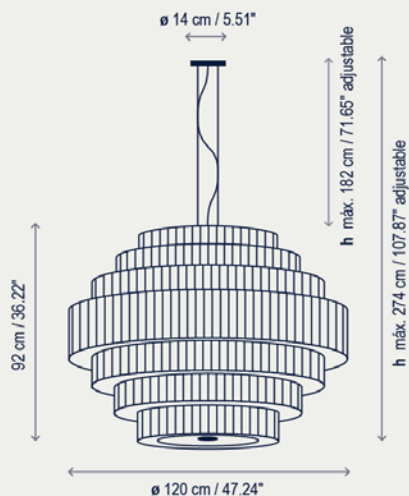

- 224P621U White Translucent Ribbon
- 224P625U Cream Translucent Ribbon
- 224P626U Red Translucent Ribbon

White polycarbonate diffuser included
Satin nickel
Transparent connection
Adjustable tensor wire
Safety tensor wire

Finishing



Mos

Design: Joana Bover | 2008



Hotel Vincci Condal Mar / Barcelona



Poliform / Italy



Hostal Empúries / L'Escala



Ribbon / Pendant Lamp

Oliver



1 x 14 W E26 A19 CFL

1 x 10 W E26 A19 LED

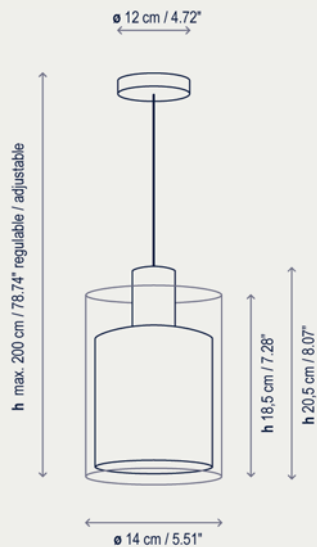

4131306U Chrome

Lampshade 4.72" X 5.12"

- P-734C White Translucent Ribbon
- P-735C Cream Translucent Ribbon
- P-736C Red Translucent Ribbon
- P-737C White Cotton
- P-738C Black Cotton
- P-739C White-Orange Inner
- P-740C Black-Orange Inner

Material: Borosilicate glass
Transparent connection
Adjustable wire



Family

pàg 272 296

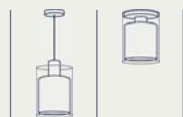

Finishing



Brilliant chrome

Cream ribbon

White ribbon

Red ribbon

White cotton

Black cotton

White fabric
Orange inside

Black fabric
Orange inside

Oliver

by Sergi Devesa / Òscar Devesa | 2013





OLIVER is clearly oriented to the Contract/Hospitality sector thanks to its features. These luminaires are made out of borosilicate glass and a warm light source to bring efficient light without glare and easy maintenance. Oliver incorporates an inner textile shade, protected from dust through the glass and available in 6 different finishes or even customized.



Ribbon / Pendant Lamp

Siam - 4 L Big Format

	120V~60Hz
	12 x 20 W E26 TRIPLE CFL
	12 x 10 W E26 A19 LED

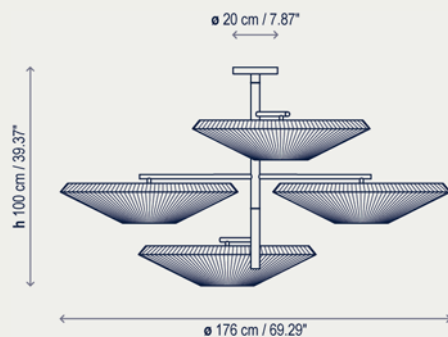

4432005U Satin Nickel Structure

Lampshade: 31.50" x 7.09" (x4 Units)

P-686CU	White Translucent Ribbon
P-687CU	Cream Translucent Ribbon
P-688CU	Red Translucent Ribbon

This ceiling lamp can be mounted to create several group or individual formations. In addition, the Siam limbs can be adjusted and moved to create stylish combinations according to the clients' needs.

Horizontal arms can be adjusted into the desired position and then locked to prevent movement.

Siam - 6 L Big Format

	120V~60Hz
	18 x 20 W E26 TRIPLE CFL
	18 x 10 W E26 A19 LED

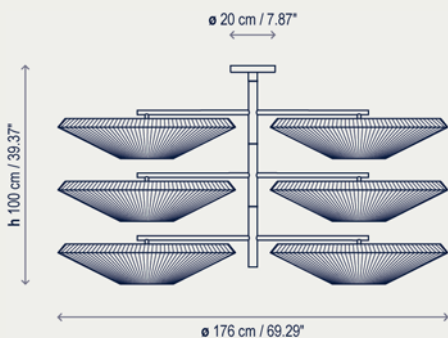

4632005U Satin Nickel Structure

Lampshade: 31.50" x 7.09" (x 6 Units)

P-686CU	White Translucent Ribbon
P-687CU	Cream Translucent Ribbon
P-688CU	Red Translucent Ribbon

This ceiling lamp can be mounted to create several group or individual formations. In addition, the Siam limbs can be adjusted and moved to create stylish combinations according to the clients' needs.

Horizontal arms can be adjusted into the desired position and then locked to prevent movement.

Family

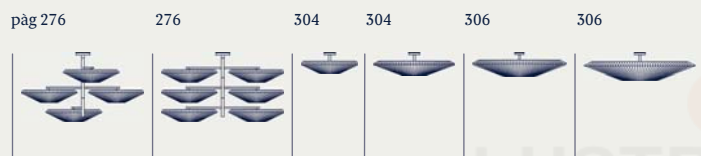

Finishing



Siam

by Joana Bover | 2010







Ribbon / Pendant Lamp

Silantra - 07

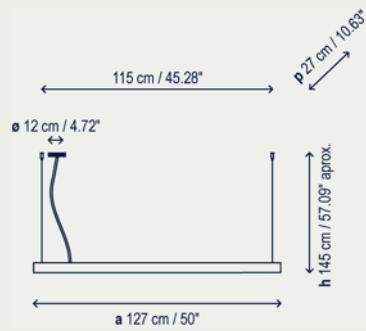

7245537U Cream Translucent Ribbon
7245538U White Translucent Ribbon

D7245537U* Dim 0-10V / Cream Translucent Ribbon
D7245538U* Dim 0-10V / White Translucent Ribbon

* Dimming Ballast (Dim 0-10V)

Polished aluminium
Lampshade 50" x 10.63"

Family

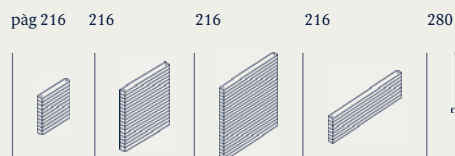

Finishing



Silantra

by Christophe Mathieu | 2004











Ribbon / Pendant Lamp

Tau

- |  120V~60Hz |  |
- |  3 x 60 W E26 A15 INC |
- |  3 x 5 W E26 A15 LED |
- |  3 x 14 W E26 TRIPLE CFL |

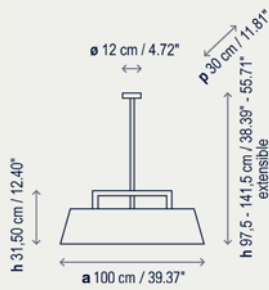

- 4323905U Satin Nickel
- 4323960U Nickel Dark Leather
- 4323961U Nickel Caramel Leather

Rectangular lampshade 39.37" x 11.81" x 9.06"

- P-482C Linen
- P-483C Cotton
- P-683 White Translucent Ribbon
- P-684 Cream Translucent Ribbon

With lower diffuser

Family

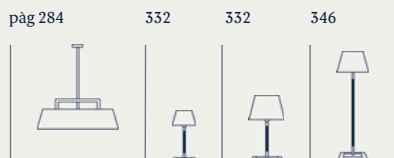

Finishing

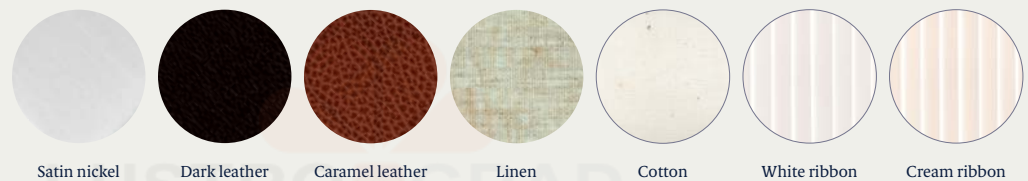

Tau

by Joana Bover | 2002



Ribbon / Pendant Lamp

Tekno - LP100

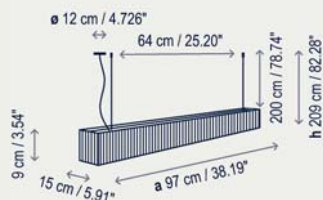
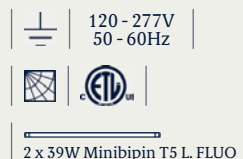

- 4218801U White Translucent Ribbon
- 4218802U Cream Translucent Ribbon
- 4218803U White Cotton
- 4218804U Red Translucent Ribbon
- D4218801U* Dim 0-10V / White Translucent Ribbon
- D4218802U* Dim 0-10V / Cream Translucent Ribbon
- D4218803U* Dim 0-10V / White Cotton
- D4218804U* Dim 0-10V / Red Translucent Ribbon

* Dimming Ballast (Dim 0-10V)

Due to translucent ribbon's nature, light colour shade may reflect the inner structure.

Tekno - LP120

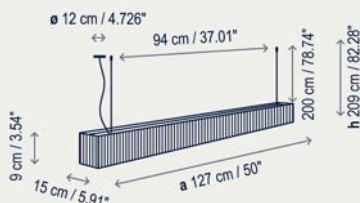
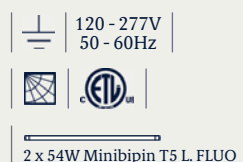

- 4318801U White Translucent Ribbon
- 4318802U Cream Translucent Ribbon
- 4318803U White Cotton
- 4318804U Red Translucent Ribbon
- D4318801U* Dim 0-10V / White Translucent Ribbon
- D4318802U* Dim 0-10V / Cream Translucent Ribbon
- D4318803U* Dim 0-10V / White Cotton
- D4318804U* Dim 0-10V / Red Translucent Ribbon

* Dimming Ballast (Dim 0-10V)

Due to translucent ribbon's nature, light colour shade may reflect the inner structure.



Finishing

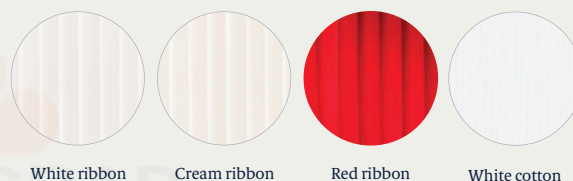

Tekno

by Joana Bover | 2003



Ribbon / Pendant Lamp

Tekno - CP

- 120V-60Hz | 
- 2 x 100 W E26 A19 INC |
- 2 x 10 W E26 A19 LED |
- 2 x 14 W E26 TRIPLE CFL |

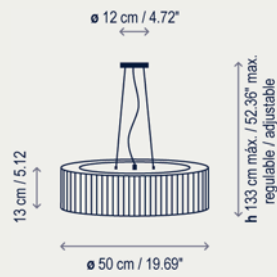

- 4118856U Nickel White Cotton
- 4118857U Nickel White Translucent Ribbon
- 4118858U Nickel Cream Translucent Ribbon
- 4118859U Nickel Red Translucent Ribbon

Adjustable tensor wire
Red wire connection

Finishing

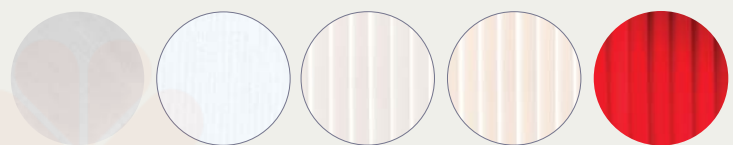

Satin nickel

White cotton

White ribbon

Cream ribbon

Red ribbon

Tekno - CP

by Joana Bover | 2003



Ribbon / Pendant Lamp

Urban - 37

- 120V~60Hz
- 2 x 60 W E26 A15 INC
- 2 x 5 W E26 A15 LED
- 2 x 14 W E26 TRIPLE CFL

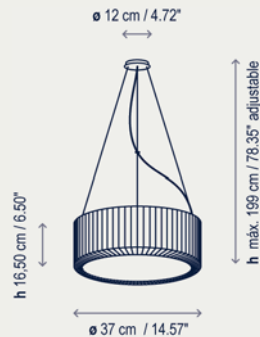

- 410132506BU Chrome-White Translucent Ribbon
- 410132506CU Chrome-Cream Translucent Ribbon
- 410132506RU Chrome-Red Translucent Ribbon

Urban - 60

- 120V~60Hz
- 4 x 60 W E26 A15 INC
- 4 x 5 W E26 A15 LED
- 4 x 14 W E26 TRIPLE CFL

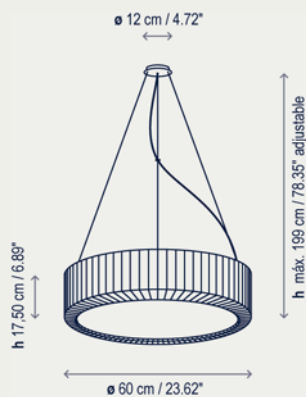

- 410232506BU Chrome-White Translucent Ribbon
- 410232506CU Chrome-Cream Translucent Ribbon
- 410232506RU Chrome-Red Translucent Ribbon

Urban - 90 Big Format

- 120V~60Hz
- 6 x 14 W E26 TRIPLE CFL
- 6 x 5 W E26 A15 LED

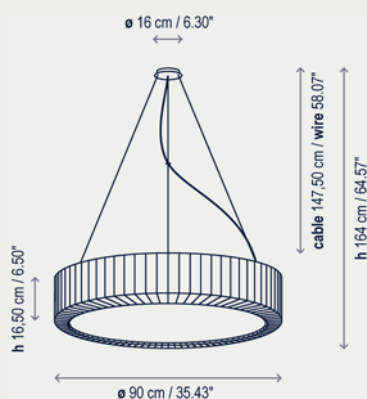

- 410432506BU Chrome-White Translucent Ribbon
- 410432506CU Chrome-Cream Translucent Ribbon
- 410432506RU Chrome-Red Translucent Ribbon

Family

pàg 290 290 290 292 314 314 314 314



Finishing



Brilliant chrome

White ribbon

Cream ribbon

Red ribbon

Urban

by Joana Bover | 2011



Restaurant Pasarela / La Roca Village

Ribbon / Pendant Lamp

Urban - 120 Big Format

- 120 - 277V
50 - 60Hz
- 6 x 36 W 2G11 TWIN CFL

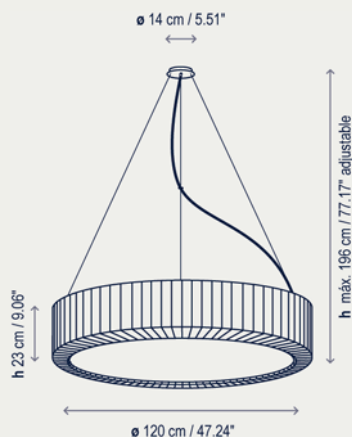

- 410332506BU Chrome-White Translucent Ribbon
- 410332506CU Chrome-Cream Translucent Ribbon
- 410332506RU Chrome-Red Translucent Ribbon
- D410332506BU* Dim 0-10V / Chrome-White Translucent Ribbon
- D410332506CU* Dim 0-10V / Chrome-Cream Translucent Ribbon
- D410332506RU* Dim 0-10V / Chrome-Red Translucent Ribbon

* Dimming Ballast (Dim 0-10V)



The URBAN collection is part of the BOVER product line usually used in the Contract/Hospitality sector but also created for the Residential market. The metallic ring which holds the bottom of the structure, functions as well as a decorative element of the large light diffuser. The light emitted by this lamp, as the major part of BOVER luminaires, is warm and cozy.

Family



Finishing

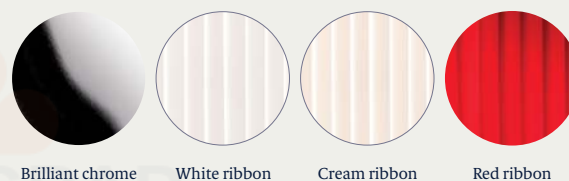



Restaurant Hotel Vincci Bit / Barcelona

Ribbon / Ceiling Lamp

Kuadrat - F

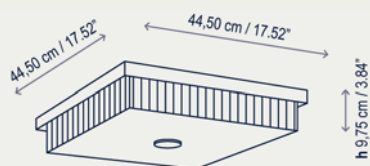
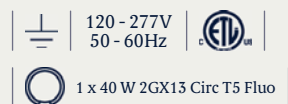

- 5015105FU Satin Nickel
- 5015106FU Brilliant Chrome
- 5015108FU Grey Graphite

Not dimmable

Inner cotton shade in polyester

- P-628 White Cotton
- P-629 White Translucent Ribbon
- P-630 Cream Translucent Ribbon

Diffuser: optical matte glass diffuser

Kuadrat - I

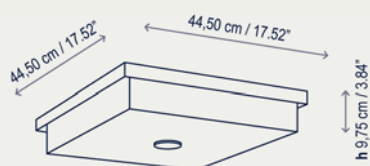

- 5015105IU Satin Nickel
- 5015106IU Brilliant Chrome
- 5015108IU Grey Graphite

Inner cotton shade in polyester

- P-628 White Cotton
- P-629 White Translucent Ribbon
- P-630 Cream Translucent Ribbon

Diffuser: optical matte glass diffuser



Finishing



Kuadrat

by Joana Bover | 2008



Ribbon / Ceiling Lamp

Oliver

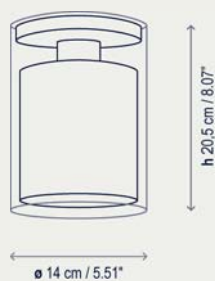
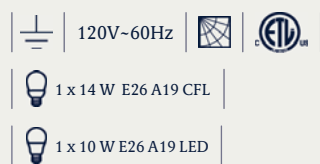

5131306U Chrome

Lampshade 4.72"x 5.12"

P-734C	White Translucent Ribbon
P-735C	Cream Translucent Ribbon
P-736C	Red Translucent Ribbon
P-737C	White Cotton
P-738C	Black Cotton
P-739C	White-Orange Inner
P-740C	Black-Orange Inner

Material: Borosilicate glass



Family

påg 272 296



Finishing

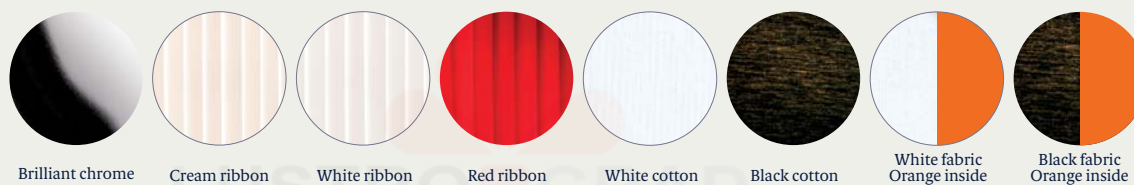

Oliver

by Sergi Devesa / Òscar Devesa | 2013



Ribbon / Ceiling Lamp

Plafonet - 43 Fonda Europa

120V-60Hz 

2 x 60 W E26 A15 INC

2 x 5 W E26 A15 LED

2 x 13 W GU24 T2 CFL

2 x 10W GU24 A15 LED

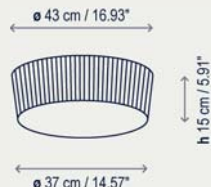

0124905CU	Inox-Cream Translucent Ribbon
0124905CGU	Inox-Cream Translucent Ribbon / GU24
0124905BU	Inox-White Translucent Ribbon
0124905BGU	Inox-White Translucent Ribbon / GU24
0124905TU	Inox-White Cotton
0124905TGU	Inox-White Cotton / GU24

Opal glass diffuser

Plafonet - 60 Fonda Europa

120V-60Hz 

4 x 60 W E26 A15 INC

4 x 5 W E26 A15 LED

4 x 13 W GU24 T2 CFL

4 x 10W GU24 A15 LED

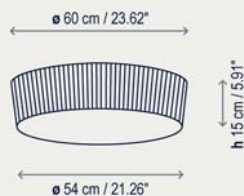

0224905CU	Inox-Cream Translucent Ribbon
0224905CGU	Inox-Cream Translucent Ribbon / GU24
0224905BU	Inox-White Translucent Ribbon
0224905BGU	Inox-White Translucent Ribbon / GU24
0224905TU	Inox-White Cotton
0224905TGU	Inox-White Cotton / GU24

Opal glass diffuser

Plafonet - 95 Fonda Europa

Big Format

120V-60Hz 

6 x 20 W E26 TRIPLE CFL

6 x 10 W E26 A19 LED

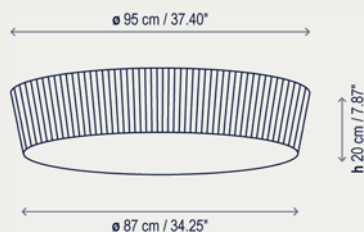

R0324905CU	Inox-Cream Translucent Ribbon
0324905BU	Inox-White Translucent Ribbon
0324905TU	Inox-White Cotton

Opal polycarbonate diffuser

Finishing



Cream ribbon

White ribbon

White cotton

Plafonet

by Carles Riart / Lluís Porqueras / Joana Bover | 2005







Ribbon / Ceiling Lamp

Rondo - F

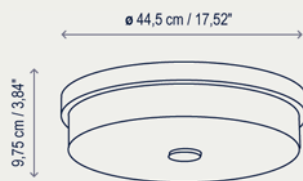
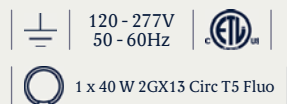

- 5015005FU Satin Nickel
- 5015006FU Brilliant Chrome
- 5015008FU Grey Graphite

Not dimmable

Inner shade in polyester

- P-576 White Translucent Ribbon
- P-577 Cream Translucent Ribbon
- P-578 White Cotton

Diffuser: optical matte glass diffuser

Rondo - I

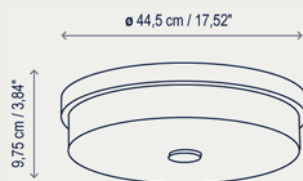
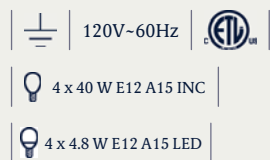

- 5015005IU Satin Nickel
- 5015006IU Brilliant Chrome
- 5015008IU Grey Graphite

Inner shade in polyester

- P-576 White Translucent Ribbon
- P-577 Cream Translucent Ribbon
- P-578 White Cotton

Diffuser: optical matte glass diffuser



Finishing



Satin nickel

Brilliant chrome

Grey graphite

White cotton

White ribbon

Cream ribbon





Rondo

by Joana Bover | 2007



Ribbon / Ceiling Lamp

Siam - 80

- |  120V-60Hz |
- |   |
- |  3 x 20 W E26 TRIPLE CFL |
- |  3 x 10 W E26 A19 LED |

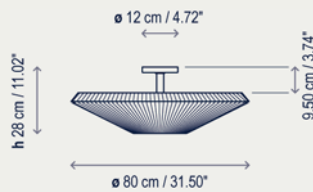

0132005U Satin Nickel

- P-686CU White Translucent Ribbon
- P-687CU Cream Translucent Ribbon
- P-688CU Red Translucent Ribbon

Siam - 120 Big Format

- |  120V-60Hz |
- |   |
- |  6 x 60 W E26 A15 INC |
- |  6 x 10 W E26 A19 LED |
- |  6 x 20 W E26 TRIPLE CFL |

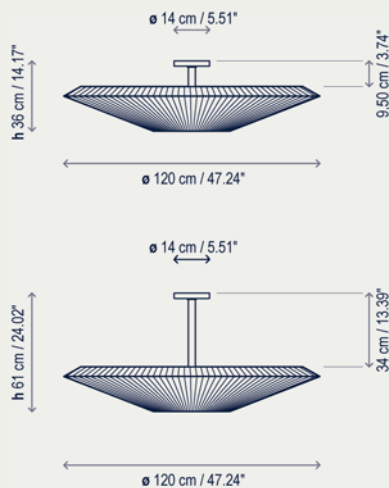

0232005PU Structure 01 Satin Nickel
0232005GU Structure 02 Satin Nickel

- P-698CU White Translucent Ribbon
- P-699CU Cream Translucent Ribbon
- P-700CU Red Translucent Ribbon

This ceiling lamp allows several individual or group compositions.
Available in two sizes
Superimposing shades partially, one on another, we will obtain a mural suitable for each space and need.

Family

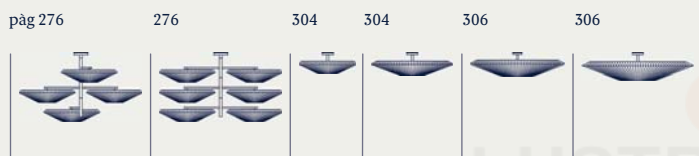

Finishing

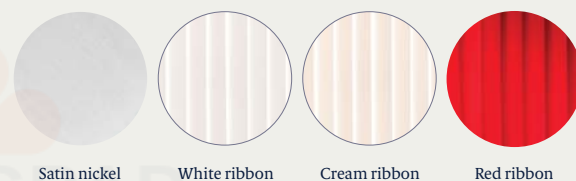

Siam

by Joana Bover | 2010



Ribbon / Ceiling Lamp

Siam - 150 Big Format

-  120V-60Hz
-  
-  6 x 60 W E26 A15 INC
-  6 x 10 W E26 A19 LED
-  6 x 20 W E26 TRIPLE CFL

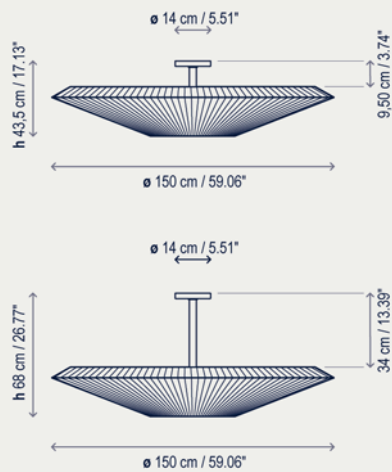

- 0532005PU Structure 01 Satin Nickel
- 0532005GU Structure 02 Satin Nickel

- P-773C White Translucent Ribbon
- P-774C Cream Translucent Ribbon
- P-775C Red Translucent Ribbon

This ceiling lamp allows several individual or group compositions. Superimposing shades partially, one on another, we will obtain a mural suitable for each space and need.

Siam - 200 Big Format

-  120V-60Hz
-  
-  8 x 60 W E26 A15 INC
-  8 x 10 W E26 A19 LED
-  8 x 20 W E26 TRIPLE CFL

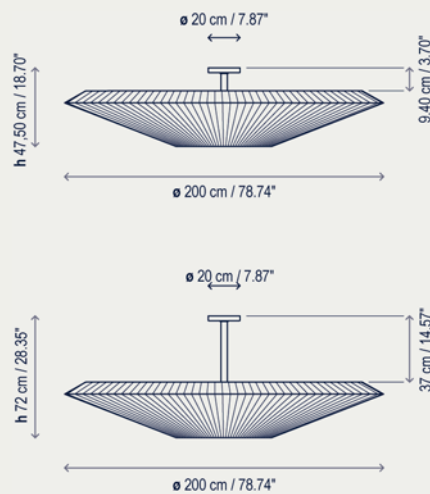

- 0332005PU Structure 01 Satin Nickel
- 0332005GU Structure 02 Satin Nickel

- P-690CU White Translucent Ribbon
- P-691CU Cream Translucent Ribbon
- P-692CU Red Translucent Ribbon

This ceiling lamp can be mounted to create several group or individual formations.

Family

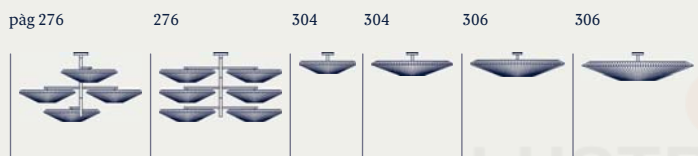

Finishing





SIAM breaths a certain
oriental air derived from
the inverted shade.
It takes its essence from
MEI and offers a soft
cascading light.
These luminaires can
be grouped in varying
compositions, superposing
shades partially one over
the other, and creating a
perfect mural for any space.













Custom Pendant Version



Ribbon / Ceiling Lamp

Urban - 37

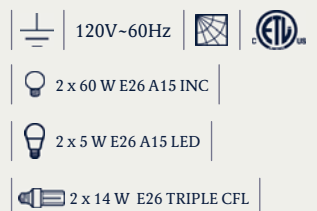

0132506BU Chrome-White Translucent Ribbon
 0132506CU Chrome-Cream Translucent Ribbon
 0132506RU Chrome-Red Translucent Ribbon

Urban - 60

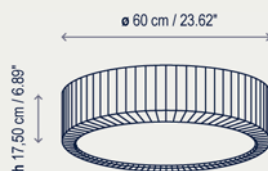

0232506BU Chrome-White Translucent Ribbon
 0232506CU Chrome-Cream Translucent Ribbon
 0232506RU Chrome-Red Translucent Ribbon

Urban - 90 Big Format

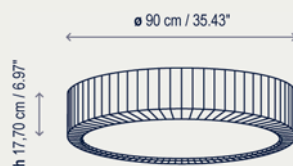

0432506BU Chrome-White Translucent Ribbon
 0432506CU Chrome-Cream Translucent Ribbon
 0432506RU Chrome-Red Translucent Ribbon
 D0432506BU Dim 0-10V / Chrome-White Translucent Ribbon
 D0432506CU Dim 0-10V / Chrome-Cream Translucent Ribbon
 D0432506RU Dim 0-10V / Chrome-Red Translucent Ribbon

* Dimming Ballast (Dim 0-10V)

Urban - 120 Big Format

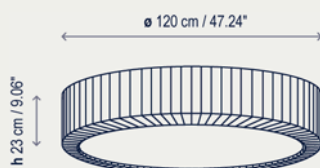
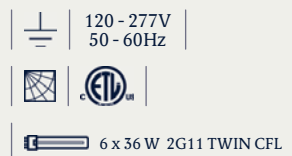

0332506BU Chrome-White Translucent Ribbon
 0332506CU Chrome-Cream Translucent Ribbon
 0332506RU Chrome-Red Translucent Ribbon
 D0332506BU* Dim 0-10V / Chrome-White Translucent Ribbon
 D0332506CU* Dim 0-10V / Chrome-Cream Translucent Ribbon
 D0332506RU* Dim 0-10V / Chrome-Red Translucent Ribbon

* Dimming Ballast (Dim 0-10V)

Family



Finishing



Urban

by Joana Bover | 2011







Ribbon / Table Lamp

Carlota - T

	120V-60Hz	
	1 x 60 W E26 A15 INC	
	1 x 5 W E26 A15 LED	
	1 x 13 W GU24 T2 CFL	
	1 x 10 W GU24 A15 LED	



1924005U	Satin Nickel
1924006U	Brilliant Chrome
1924060U	Nickel Dark Leather
1924061U	Nickel Caramel Leather
1924005GU	Satin Nickel / GU24
1924006GU	Brilliant Chrome / GU24
1924060GU	Nickel Dark Leather / GU24
1924061GU	Nickel Caramel Leather / GU24

Square lampshade 7.87" x 5.91" x 3.94"

P-107	Cotton
P-202	White Translucent Ribbon
P-203	Cream Translucent Ribbon

Swivel arm / Transparent Switch + wire.

Family

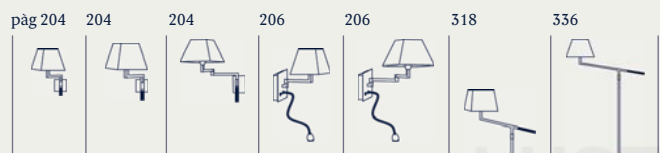

Finishing



Carlota

by Joana Bover | 2003



Ribbon / Table Lamp

Cornelia - T

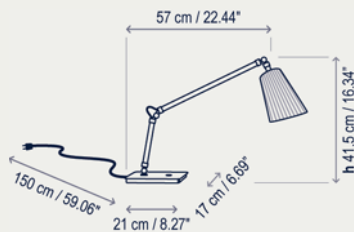
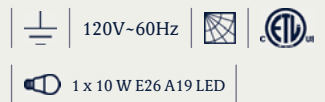

- 2620130541U Matte White / Polished Brass
- 2620130542U Matte Black / Chrome
- 2620130544U Matte White / Chrome
- 2620130545U Matte Black / Polished Brass

Cone-shaped shade 6.50" x 8.86" x 3.15"

- P-817 White Translucent Ribbon
- P-818 Cream Translucent Ribbon
- P-819 Red Translucent Ribbon
- P-820 White Cotton
- P-821 Black Cotton
- P-822 White Fabric - Orange Inside
- P-823 Black Fabric - Orange Inside
- P-824 Black Fabric - Gold Inside
- P-825 Black Fabric - Silver Inside

Finishing



White ribbon

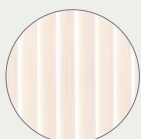

Cream ribbon

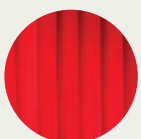

Red ribbon

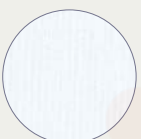

White cotton

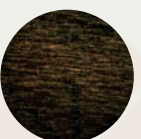

Black cotton

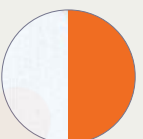

White fabric
Orange inside

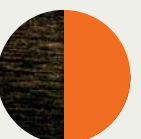

Black fabric
Orange inside

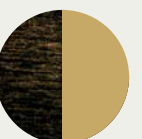

Black fabric
Gold inside

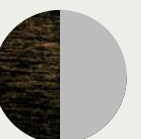

Black fabric
Silver inside

Finishing

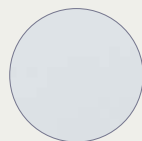

Matte White



Matte Black







Ribbon / Table Lamp

Danona - Mini

- 120V-60Hz 
-  1 x 60 W E26 A15 INC
-  1 x 5 W E26 A15 LED
-  1 x 13 W GU24 T2 CFL
-  1 x 10 W GU24 A15 LED

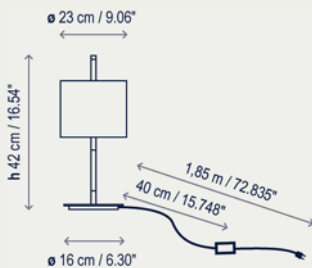

- 2023105U Satin Nickel
- 2023160U Nickel Dark Leather
- 2023161U Nickel Caramel Leather
- 2023105GU Satin Nickel / GU24
- 2023160GU Nickel Dark Leather / GU24
- 2023161GU Nickel Caramel Leather / GU24

Lampshade 9.06" x 6.69" x 9.06"
Lampshade components and polycarbonate diffuser included
Transparent wire

- P-230U Cotton
- P-003U Cream Translucent Ribbon
- P-004U White Translucent Ribbon

Danona - T

- 120V-60Hz 
-  1 x 60 W E26 A15 INC
-  1 x 5 W E26 A15 LED
-  1 x 13 W GU24 T2 CFL
-  1 x 10 W GU24 A15 LED

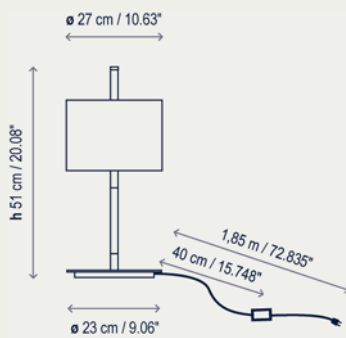

- 2123105U Satin Nickel
- 2123160U Nickel Dark Leather
- 2123161U Nickel Caramel Leather
- 2123105GU Satin Nickel / GU24
- 2123160GU Nickel Dark Leather / GU24
- 2123161GU Nickel Caramel Leather / GU24

Lampshade 10.63" x 7.09" x 10.63"
Lampshade components and polycarbonate diffuser included
Transparent wire

- P-227U Cotton
- P-005U Cream Translucent Ribbon
- P-006U White Translucent Ribbon

Family

påg 234 234 324 324 338



Finishing



Danona

by Joana Bover | 2002



Danona is the collection which best has been adapted to the changes in Bover. It has been present from the very beginning, a contemporaneous and timeless product adaptable to any environment. Danona is a product which can be customized and has a good quality-price balance.

Ribbon / Table Lamp

Ema - T

- 120V-60Hz 
- 1 x 60 W E26 A15 INC 
- 1 x 5 W E26 A15 LED 
- 1 x 13 W GU24 T2 CFL 
- 1 x 10 W GU24 A15 LED 

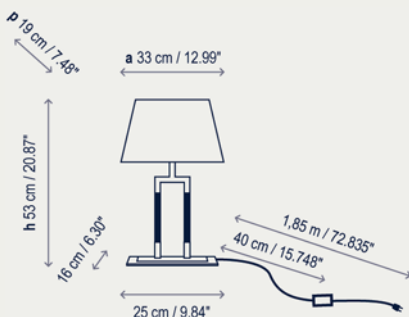

- 2119405U Satin Nickel
- 2119460U Nickel Dark Leather
- 2119461U Nickel Caramel Leather
- 2119405GU Satin Nickel / GU24
- 2119460GU Nickel Dark Leather / GU24
- 2119461GU Nickel Caramel Leather / GU24

Rectangular lampshade 12.99" x 7.48" x 8.27"

- P-478 Linen
- P-479 Cotton

Inox Base
 Finish: Satin nickel – Brilliant chrome
 Transparent wire

Black cotton shade special order

Family

påg 326 340



Finishing

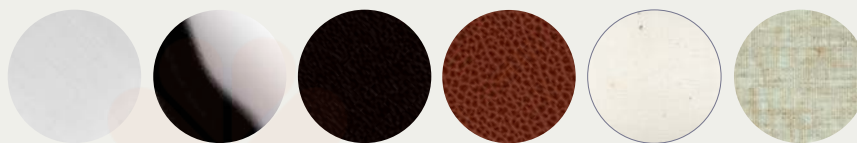

Satin nickel Brilliant chrome Dark leather Caramel leather Cotton Linen

Ema

by Joana Bover | 2004



Ribbon / Table Lamp

Mani - Mini

- 120V-60Hz | 
- 1 x 60 W E26 A15 INC | 
- 1 x 5 W E26 A15 LED | 
- 1 x 15 W GU24 T2 CFL | 
- 1 x 10 W GU24 A15 LED | 

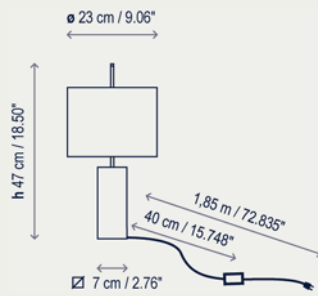

- 2028510U Nickel White Lacquer
- 2028514U Nickel Wengue Wood
- 2028510GU Nickel White Lacquer / GU24
- 2028514GU Nickel Wengue Wood / GU24

Lampshade 9.06" x 6.69" x 9.06"

- P-003U Cream Translucent Ribbon
- P-004U White Translucent Ribbon
- P-230U Cotton

Lampshade components and polycarbonate diffuser included

Transparent wire + switch

Mani - T

- 120V-60Hz | 
- 2 x 60 W E26 A15 INC | 
- 2 x 5 W E26 A15 LED | 
- 2 x 15 W GU24 T2 CFL | 
- 2 x 10 W GU24 A15 LED | 

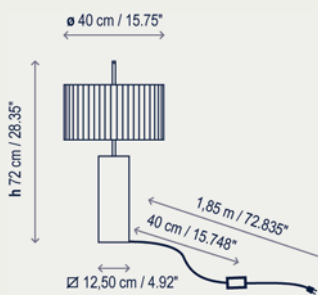

- 2128510U Nickel White Lacquer
- 2128514U Nickel Wengue Wood
- 2128510GU Nickel White Lacquer / GU24
- 2128514GU Nickel Wengue Wood / GU24

Lampshade 15.75" x 8.66" x 15.75"

- P-133U Cotton
- P-137U White Translucent Ribbon
- P-138U Cream Translucent Ribbon

Lampshade components and polycarbonate diffuser included

Transparent wire + switch



Mini / Bedside



Table

Finishing



Satin nickel

Cotton

Cream ribbon

White ribbon

White lacquer

Wengue

Mani

by Taller / Estudi Bover | 1997



Ribbon / Table Lamp

Mei Oval - T

- 120V-60Hz 
-  1 x 60 W E26 A15 INC
-  1 x 5 W E26 A15 LED
-  1 x 13 W GU24 T2 CFL
-  1 x 10 W GU24 A15 LED

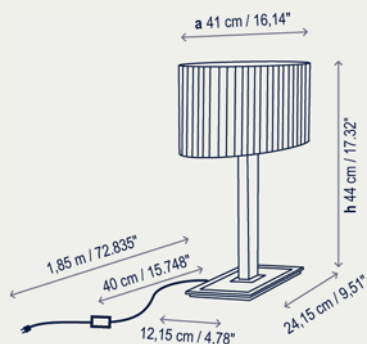

- 2125023U Chrome Black Glass
- 2125017U Nickel Black Glass

- 2125023GU Chrome Black Glass / GU24
- 2125017GU Nickel Black Glass / GU24

Oval lampshade 16.14" x 6.89" x 5.91"
Upper black glass diffuser

- P-551D White Translucent Ribbon
- P-552D Cream Translucent Ribbon
- P-553D Black Translucent Ribbon
- P-554D White Cotton

Transparent wire

Mei Oval - T/USB

- 120V-60Hz 
-  1 x 60 W E26 A15 INC
-  1 x 5 W E26 A15 LED
-  1 x 13 W GU24 T2 CFL
-  1 x 10 W GU24 A15 LED

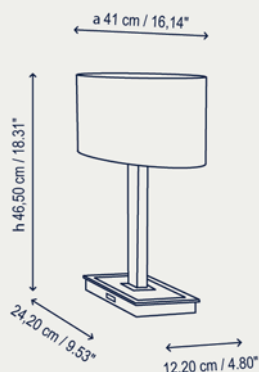

- 2125017USBU Nickel Black Glass
- 2125023USBU Chrome Black Glass
- 2125017USBGU Nickel Black Glass / GU24
- 2125023USBGU Chrome Black Glass / GU24

Oval lampshade 16.14" x 6.89" x 5.91"
Upper diffuser black glass

- P-551D White Translucent Ribbon
- P-552D Cream Translucent Ribbon
- P-553D Black Translucent Ribbon
- P-554D White Cotton

USB port located on the base

Mei Oval - T2/USB

- 120V-60Hz 
-  1 x 60 W E26 A15 INC
-  1 x 5 W E26 A15 LED
-  1 x 13 W GU24 T2 CFL
-  1 x 10 W GU24 A15 LED

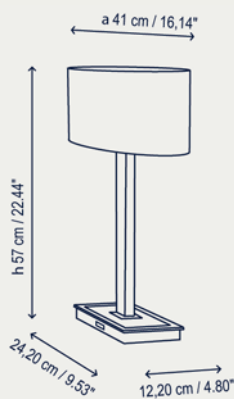

- 4125017USBU Nickel Black Glass
- 4125023USBU Chrome Black Glass
- 4125017USBGU Nickel Black Glass / GU24
- 4125023USBGU Chrome Black Glass / GU24

Oval lampshade 16.14" x 7.87" x 5.91"
Upper diffuser black glass

- P-805D White Translucent Ribbon
- P-806D Cream Translucent Ribbon
- P-807D Black Translucent Ribbon
- P-808D White Cotton

USB port located on the base



Family

pàg 212 266 330 330 330 344

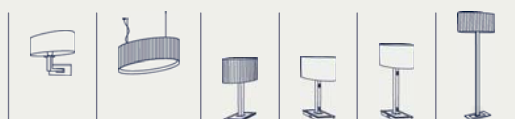

Finishing

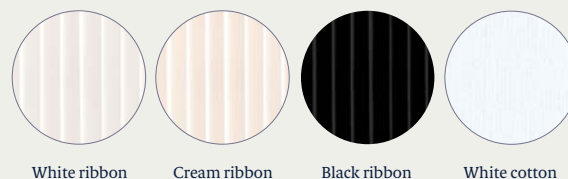

White ribbon

Cream ribbon

Black ribbon

White cotton

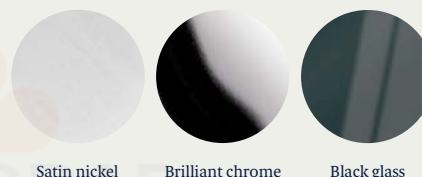

Satin nickel

Brilliant chrome

Black glass



Mei Oval

by Joana Bover | 2006



Ribbon / Table Lamp

Tau - Mini

120V-60Hz	
 1 x 60 W E26 A15 INC	
 1 x 5 W E26 A15 LED	

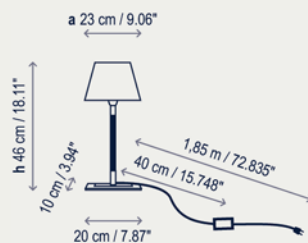



2023960U	Nickel Dark Leather
2023961U	Nickel Caramel Leather
2023905U	Satin Nickel Chrome

Rectangular lampshade 9.06" x 5.12" x 5.91"

P-474	Linen
P-475	Cotton
P-671	White Translucent Ribbon
P-672	Cream Translucent Ribbon

Inox base: Satin nickel-Brilliant chrome
Transparent wire + switch

Tau - T

120V-60Hz	
 1 x 60 W E26 A15 INC	
 1 x 5 W E26 A15 LED	
 1 x 13 W GU24 T2 CFL	
 1 x 10W GU24 A15 LED	

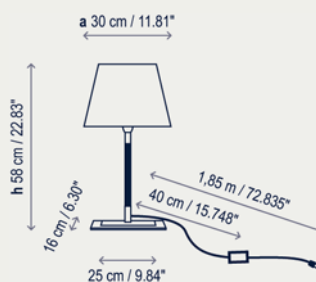

2223960U	Nickel Dark Leather
2223961U	Nickel Caramel Leather
2223905U	Satin Nickel-Chrome
2223960GU	Nickel Dark Leather / GU24
2223961GU	Nickel Caramel Leather / GU24
2223905GU	Satin Nickel-Chrome / GU24

Rectangular lampshade 12.99" x 8.66" x 8.27"

P-478	Linen
P-479	Cotton
P-674	White Translucent Ribbon
P-675	Cream Translucent Ribbon

Inox base: Satin nickel-Brilliant chrome
Transparent wire + switch

Family

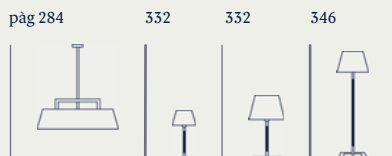

Finishing

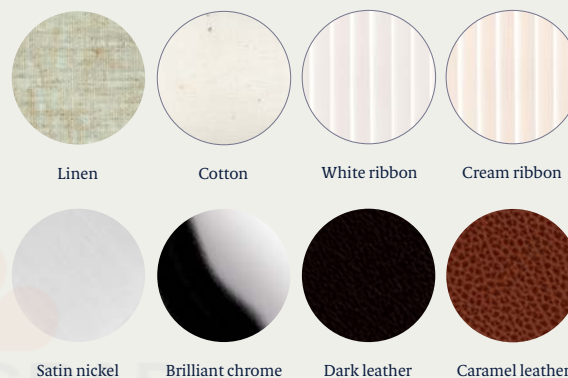

Tau

by Joana Bover | 2002



Ribbon / Table Lamp

Tau - Madera

120V-60Hz 

 1 x 60 W E26 A15 INC

 1 x 5 W E26 A15 LED

 1 x 13 W GU24 T2 CFL

 1 x 10W GU24 A15 LED

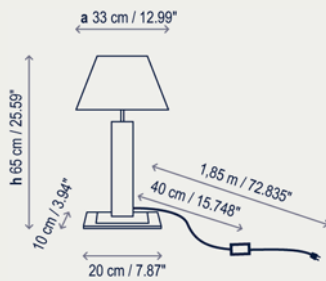

- 2123901U Nickel White Lacquer
- 2123932U Nickel Wengue
- 2123901GU Nickel White Lacquer / GU24
- 2123932GU Nickel Wengue / GU24

Inox base / Finish: Satin nickel-Brilliant chrome / Transparent wire-Black switch
Rectangular lampshade 12.99" x 8.66" x 8.27"

- P-478 Linen
- P-479 Cotton
- P-541 White Cotton
- P-674 White Translucent Ribbon
- P-675 Cream Translucent Ribbon

Finishing



Linen

Cotton

White cotton

White ribbon

Cream ribbon

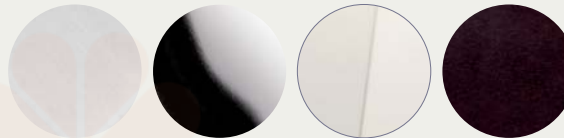

Satin nickel

Brilliant chrome

White lacquer

Wengue

Family

påg 334 348



Tau Madera

by Joana Bover | 2002



Ribbon / Floor Lamp

Carlota - P

- 120V-60Hz 
- 1 x 60 W E26 A15 INC 
- 1 x 5 W E26 A15 LED 
- 1 x 13 W GU24 T2 CFL 
- 1 x 10 W GU24 A15 LED 

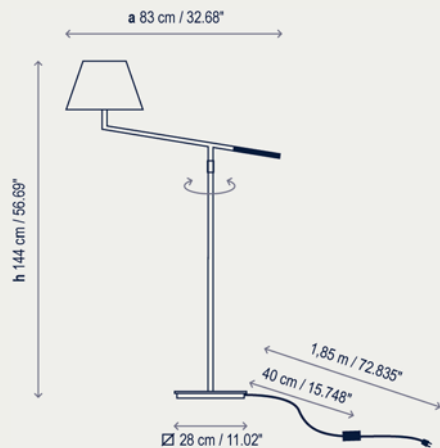

- 3124005U Satin Nickel
- 3124006U Brilliant Chrome
- 3124060U Nickel Dark Leather
- 3124061U Nickel Caramel Leather
- 3124005GU Satin Nickel / GU24
- 3124006GU Brilliant Chrome / GU24
- 3124060GU Nickel Dark Leather / GU24
- 3124061GU Nickel Caramel Leather / GU24

Square lampshade 10.63" x 8.27" x 5.91"

- P-453 Cotton
- P-455 White Translucent Ribbon
- P-456 Cream Translucent Ribbon

Swivel arm / Transparent wire. Switch black.

Family

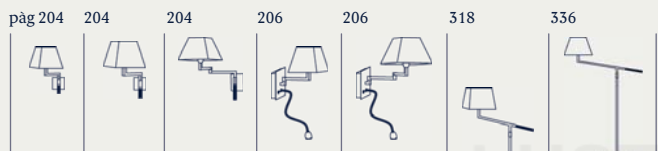

Finishing



Carlota

by Joana Bover | 2003



Ribbon / Floor Lamp

Danona - P

- | 120V-60Hz |  |
- |  2 x 60 W E26 A15 INC |
- |  2 x 5 W E26 A15 LED |
- |  2 x 13 W GU24 T2 CFL |
- |  2 x 10 W GU24 A15 LED |

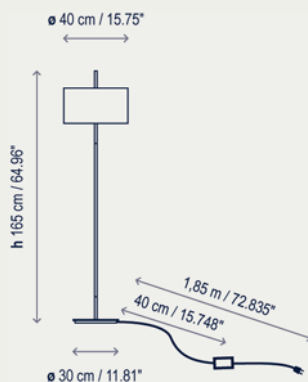

- | | |
|-----------|-------------------------------|
| 3023105U | Satin Nickel |
| 3023160U | Nickel Dark Leather |
| 3023161U | Nickel Caramel Leather |
| 3023105GU | Satin Nickel / GU24 |
| 3023160GU | Nickel Dark Leather / GU24 |
| 3023161GU | Nickel Caramel Leather / GU24 |

Lampshade 15.75" x 8.66" x 15.75"
Lampshade components and polycarbonate diffuser included
Transparent wire / black switch

- | | |
|--------|--------------------------|
| P-133U | Cotton |
| P-137U | White Translucent Ribbon |
| P-138U | Cream Translucent Ribbon |

Family

påg 234 234 324 324 338



Finishing



Danona

by Joana Bover | 2002



Ribbon / Floor Lamp

Ema - P

- 120V-60Hz | 
-  1 x 100 W E26 A19 INC
-  1 x 10 W E26 A19 LED
-  1 x 18 W GU24 T2 CFL
-  1 x 12 W GU24 A19 LED

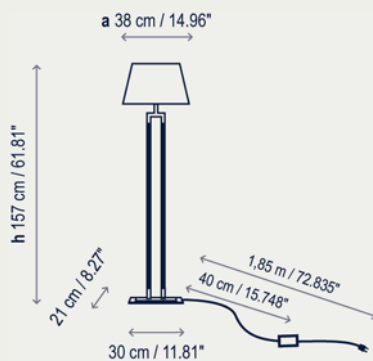

- 3019405U Satin Nickel
- 3019460U Nickel Dark Leather
- 3019461U Nickel Caramel Leather
- 3019405GU Satin Nickel / GU24
- 3019460GU Nickel Dark Leather / GU24
- 3019461GU Nickel Caramel Leather / GU24

Rectangular lampshade 14.96" x 8.66" x 9.84"

- P-480 Linen
- P-481 Cotton

Inox Base
Finish: Satin nickel – Brilliant chrome
Transparent wire

Family

pàg 326 340



Finishing







Ema

by Joana Bover | 2004



Ribbon / Floor Lamp

Maxi - 01

- 120V-60Hz 
-  4 x 60 W E26 A15 INC
-  4 x 5 W E26 A15 LED
-  4 x 13 W GU24 T2 CFL
-  4 x 10 W GU24 A15 LED

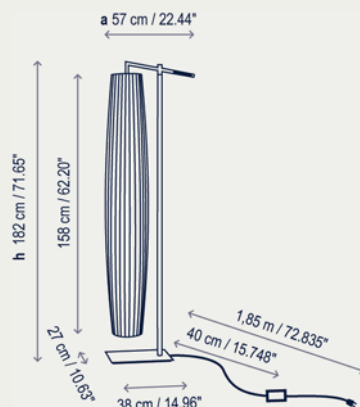





- 3019505U Satin Nickel
- 3019560U Nickel Dark Leather
- 3019561U Nickel Caramel Leather
- 3019505GU Satin Nickel / GU24
- 3019560GU Nickel Dark Leather / GU24
- 3019561GU Nickel Caramel Leather / GU24

Lampshade 62.20" x 9.84"

- P-771TU Cream Ribbon
- P-772TU White Ribbon
- P-771TGU Cream Ribbon / GU24
- P-772TGU White Ribbon / GU24

Transparent wire, black switch

Maxi - 02

- 120V-60Hz 
-  4 x 60 W E26 A15 INC
-  4 x 5 W E26 A15 LED
-  4 x 13 W GU24 T2 CFL
-  4 x 10 W GU24 A15 LED

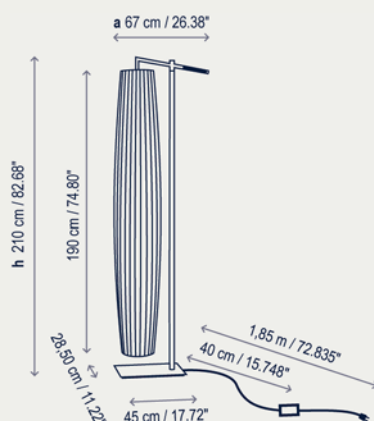

- 3219505U Satin Nickel
- 3219560U Nickel Dark Leather
- 3219561U Nickel Caramel Leather
- 3219505GU Satin Nickel / GU24
- 3219560GU Nickel Dark Leather / GU24
- 3219561GU Nickel Caramel Leather / GU24

Lampshade 74.80" x 11.81"

- P-769TU Cream Ribbon
- P-770TU White Ribbon
- P-769TGU Cream Ribbon / GU24
- P-770TGU White Ribbon / GU24

Transparent wire, black switch

Maxi - 03

- 120V-60Hz 
-  4 x 60 W E26 A15 INC
-  4 x 13 W GU24 T2 CFL
-  4 x 10 W GU24 A15 LED

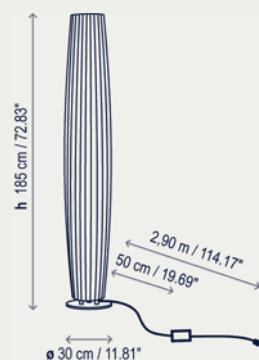

- 1950330546U Satin Nickel Cream Ribbon
- 1950330547U Satin Nickel White Ribbon
- 1950330646U Satin Nickel Cream Ribbon / GU24
- 1950330647U Satin Nickel White Ribbon / GU24

Lampshade 72.83" x 11.81"

Bulbs included

Family

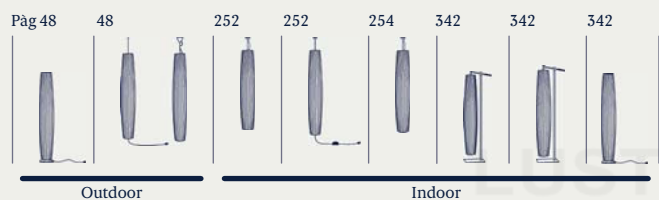

Finishing



Maxi

by Joana Bover | 2004



Ribbon / Floor Lamp

Mei Oval - P

- 120V-60Hz 
-  1 x 100 W E26 A19 INC
-  1 x 10 W E26 A19 LED
-  1 x 20 W E26 TRIPLE CFL

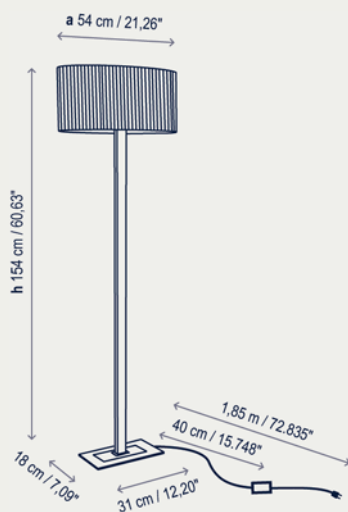

- 3025023U Chrome Black Glass
- 3025017U Nickel Black Glass

Oval lampshade 21.26" x 9.45" x 9.06"

- P-557 White Translucent Ribbon
- P-558 Cream Translucent Ribbon
- P-559 Black Translucent Ribbon
- P-560 White Cotton

Family

påg 212 266 330 330 330 344



Finishing

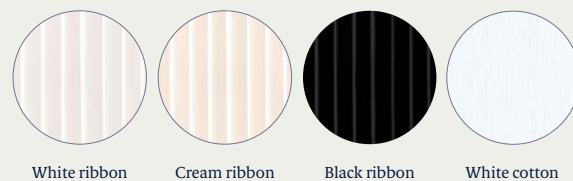

White ribbon

Cream ribbon

Black ribbon

White cotton

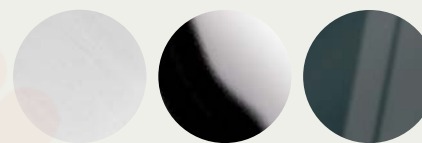

Satin nickel

Brilliant chrome

Black glass

Mei Oval

by Joana Bover | 2006



Ribbon / Floor Lamp

Tau - P

- 120V-60Hz 
-  1 x 60 W E26 A15 INC
-  1 x 5 W E26 A15 LED
-  1 x 13 W GU24 T2 CFL
-  1 x 10W GU24 A15 LED

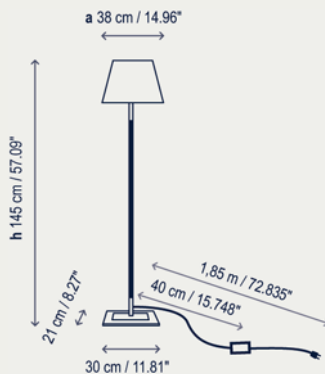

- 3023960U Nickel Dark Leather
- 3023961U Nickel Caramel Leather
- 3023905U Satin Nickel-Chrome
- 3023960GU Nickel Dark Leather / GU24
- 3023961GU Nickel Caramel Leather / GU24
- 3023905GU Satin Nickel-Chrome / GU24

Inox base / Finish: Satin nickel-Brilliant chrome / Transparent wire-Black switch
Rectangular lampshade 14.96" x 9.84" x 10.24"

- P-480 Linen
- P-481 Cotton
- P-677 White Translucent Ribbon
- P-678 Cream Translucent Ribbon

Family

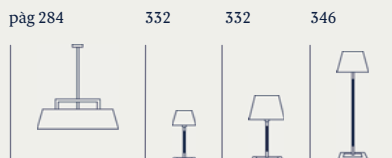

Finishing





Tau

by Joana Bover | 2002

Ribbon / Floor Lamp

Tau Madera

120V-60Hz 

 1 x 60 W E26 A15 INC

 1 x 5 W E26 A15 LED

 1 x 14 W E26 TRIPLE CFL

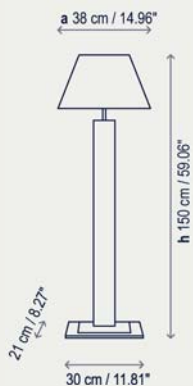

3023901U Nickel White Lacquer
3023932U Nickel Wengue

Inox base / Finish: Satin nickel-Brilliant chrome / Transparent wire-Black switch
Rectangular lampshade 14.96" x 9.84" x 10.24"

P-480 Linen
P-481 Cotton
P-542 White Cotton
P-677 White Translucent Ribbon
P-678 Cream Translucent Ribbon

Family

påg 334 348



Finishing



Tau Madera

by Joana Bover | 2002





Hand-Crafted

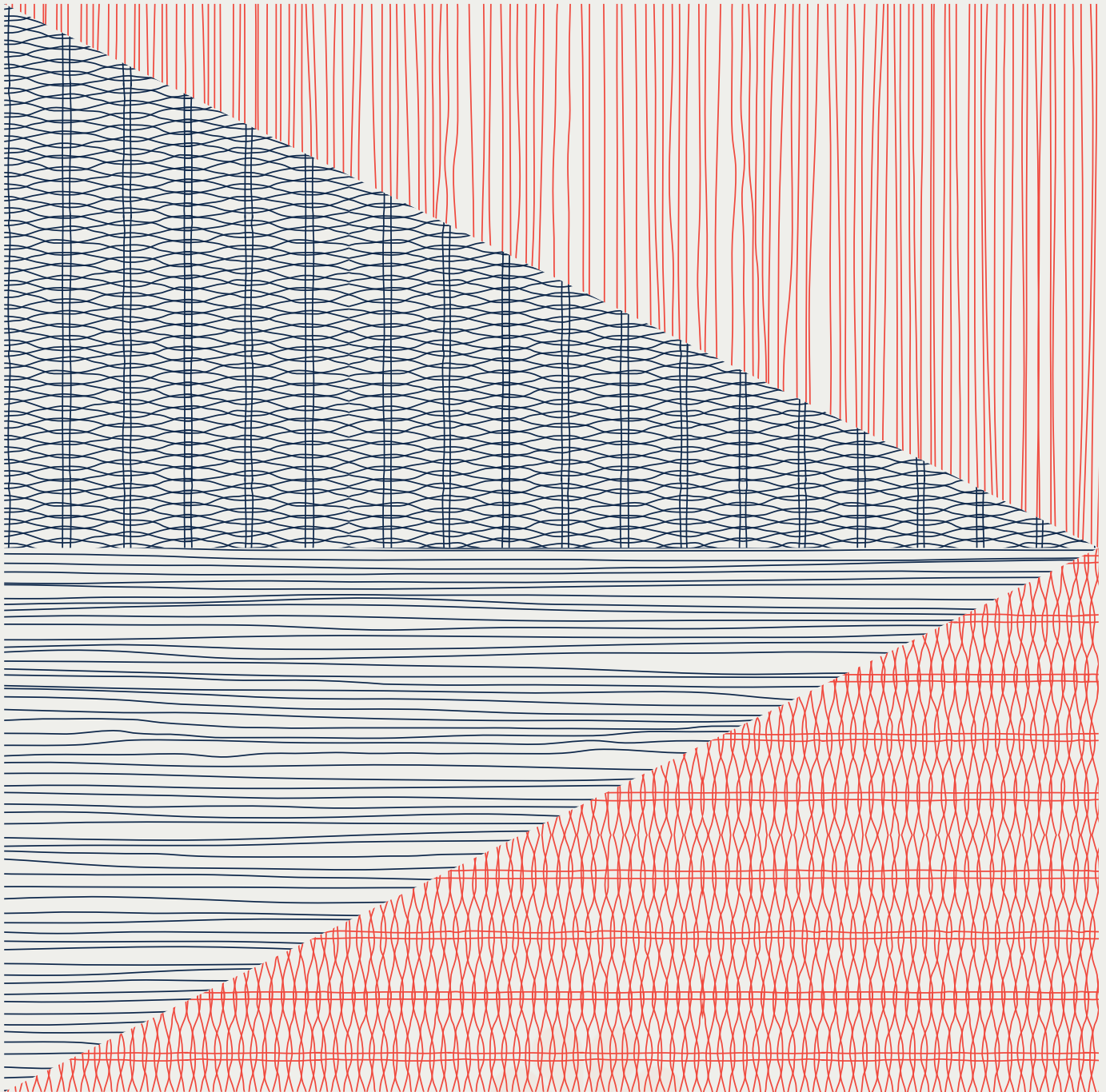

Hand crafted

Avani - Mini

Hand-Crafted Wall Lamp

120V-60Hz 

2 x 60 W E26 A15 INC | 2 x 5 W E26 A15 LED

2 x 13 W GU24 T2 CFL | 2 x 10 W GU24 A15 LED

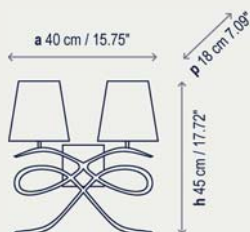

1222003U Graphite Brown Iron
1222004U Black Iron

1222003GU Graphite Brown Iron / GU24
1222004GU Black Iron / GU24

P-103 Cotton (x2)

Lampshade 7.09" x 5.91" x 4.72"

Surface back box 4.53" x 4.53"

Avani - Grande

Hand-Crafted Wall Lamp

120V-60Hz 

2 x 60 W E26 A15 INC | 2 x 5 W E26 A15 LED

2 x 13 W GU24 T2 CFL | 2 x 10 W GU24 A15 LED

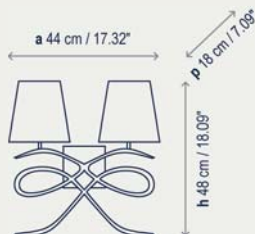

1222103U Graphite Brown Iron
1222104U Black Iron

1222103GU Graphite Brown Iron / GU24
1222104GU Black Iron / GU24

P-373 Cotton (x2)

Lampshade 7.09" x 7.09" x 4.72" Unitary Price

Surface back box 4.53" x 4.53"

Finishing



Brown iron

Black iron

Cotton

Avani

by Joana Bover | 1998



Hand crafted

Ferrara - 1 L

Hand-Crafted Wall Lamp

120V-60Hz

1 x 60 W E26 A15 INC

1 x 5 W E26 A15 LED

1 x 15 W GU24 T2 CFL

1 x 10 W GU24 A15 LED

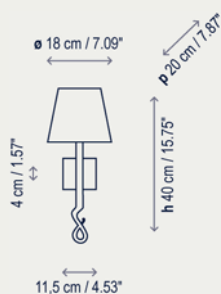

- 1124204U Black Iron
- 1124203U Graphite Brown Iron
- 1124204GU Black Iron / GU24
- 1124203GU Graphite Brown Iron / GU24

Lampshade 7.09" x 5.91" x 4.72"

- P-105 Cotton
- P-098 White Translucent Ribbon
- P-099 Cream Translucent Ribbon

Surface back box 4.33"

Ferrara - 2 L

Hand-Crafted Wall Lamp

120V-60Hz

2 x 60 W E26 A15 INC

2 x 5 W E26 A15 LED

2 x 15 W GU24 T2 CFL

2 x 10 W GU24 A15 LED

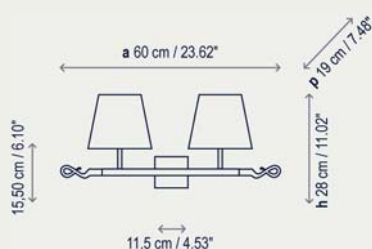

- 1224204U Black Iron
- 1224203U Graphite Brown Iron
- 1224204GU Black Iron / GU24
- 1224203GU Graphite Brown Iron / GU24

Lampshade 7.09" x 5.91" x 4.72"

- P-105 Cotton
- P-098 White Translucent Ribbon
- P-099 Cream Translucent Ribbon

Surface back box 4.33"

Ferrara - 2 L

Hand-Crafted Pendant Lamp

120V-60Hz

2 x 100 W E26 A19 INC

2 x 10 W E26 A19 LED

2 x 18 W GU24 T2 CFL

2 x 12 W GU24 A19 LED

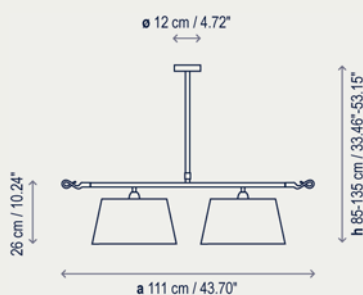

- 4224204U Black Iron
- 4224203U Graphite Brown Iron
- 4224204GU Black Iron / GU24
- 4224203GU Graphite Brown Iron / GU24

Lampshade 14.96" x 7.87" x 11.81"

- P-163CU Cotton
- P-167CU Cream Translucent Ribbon
- P-168CU White Translucent Ribbon

The shade includes upper diffuser

Family

påg 354 354

354

358

358

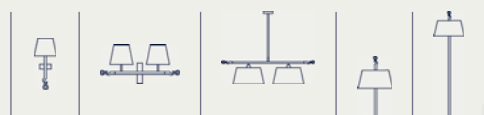

Finishing

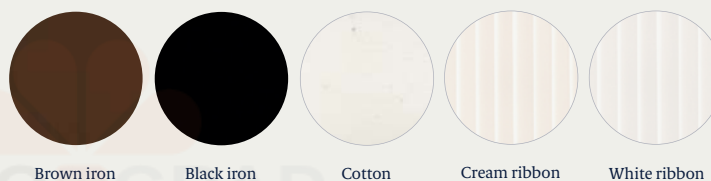

Brown iron

Black iron

Cotton

Cream ribbon

White ribbon

Ferrara

by Joana Bover | 2002

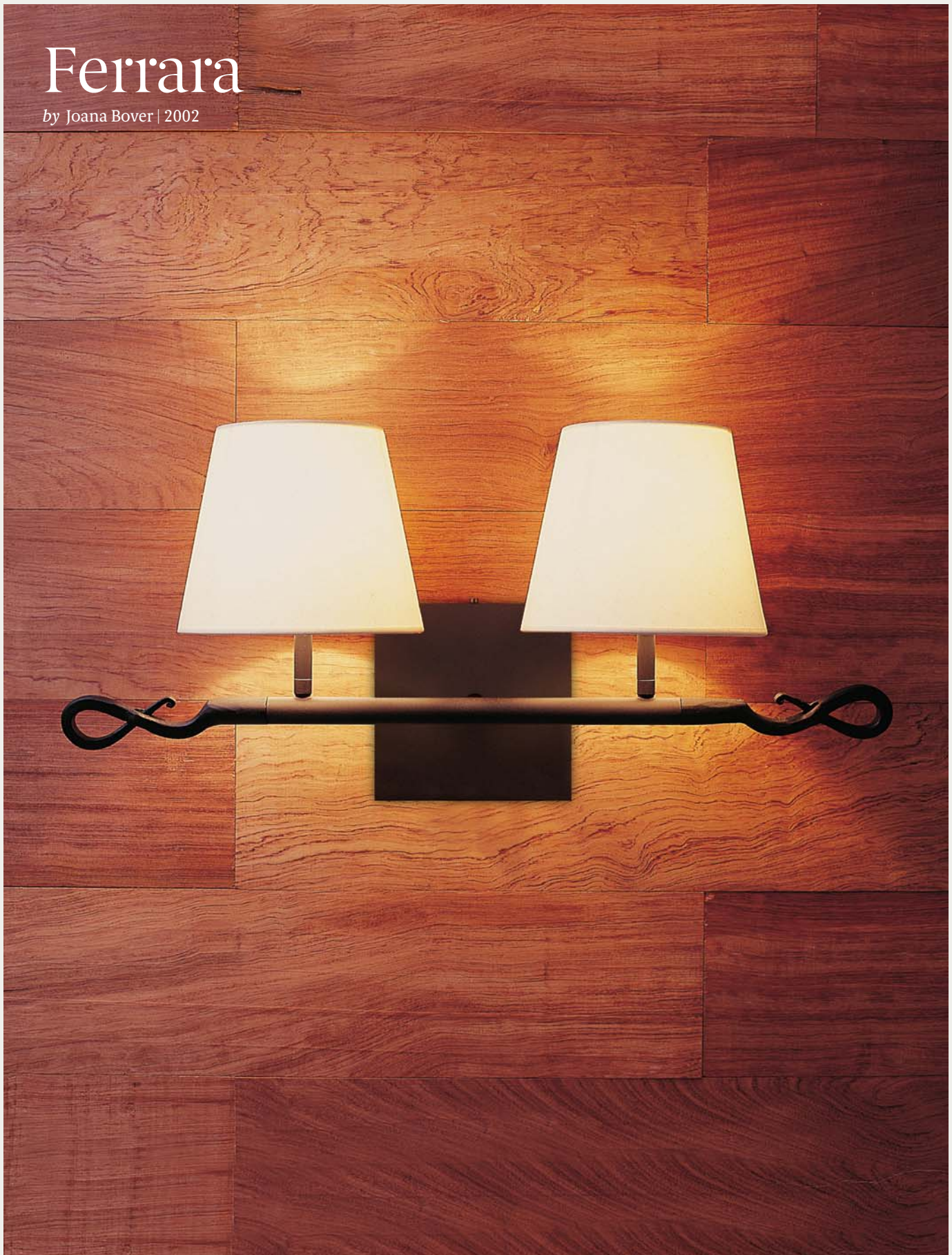





Hand crafted

Ferrara - T

Hand-Crafted Table

120V-60Hz



2 x 60 W E26 A15 INC

2 x 5 W E26 A15 LED

2 x 15 W GU24 T2 CFL

2 x 10 W GU24 A15 LED

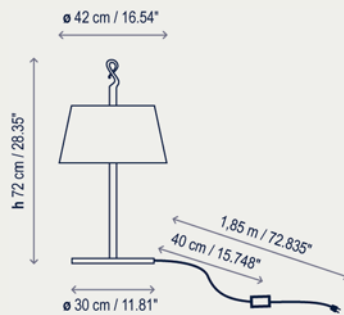

- 2224204U Black Iron
- 2224203U Graphite Brown Iron
- 2224204GU Black Iron / GU24
- 2224203GU Graphite Brown Iron / GU24

Lampshade 16.54" x 9.06" x 12.99"

- P-435U Cotton
- P-442U White Translucent Ribbon
- P-443U Cream Translucent Ribbon

Shade includes polycarbonate upper diffuser

Transparent wire

Ferrara - P

Hand-Crafted Floor

120V-60Hz



2 x 60 W E26 A15 INC

2 x 5 W E26 A15 LED

2 x 15 W GU24 T2 CFL

2 x 10 W GU24 A15 LED

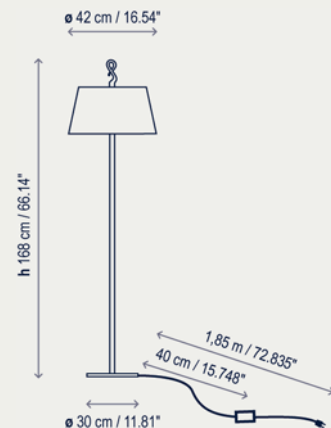

- 3024204U Black Iron
- 3024203U Graphite Brown Iron

- 3024204GU Black Iron / GU24
- 3024203GU Graphite Brown Iron / GU24

Lampshade 16.54" x 9.06" x 12.99"

- P-435U Cotton
- P-442U White Translucent Ribbon
- P-443U Cream Translucent Ribbon

Shade includes polycarbonate upper diffuser

Transparent wire

Family

påg 354 354

354

358

358

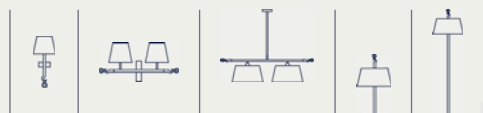

Finishing

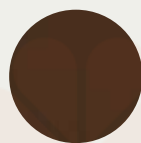

Brown iron



Black iron



Cotton



Cream ribbon



White ribbon

Ferrara

by Joana Bover | 2002





bover

barcelona lights

1231 Collier Road,
Suite C
Atlanta, GA 30318
United States

T. +1 (404) 924 2342
info@boverusa.com
www.boverusa.com

Avda. Catalunya 173
Poligon Ind. Sud
08440 Cardedeu
Barcelona, Spain

T. +34 938 713 152
F. +34 938 462 089
info@bover.es
www.bover.es