

VOLTOLINA

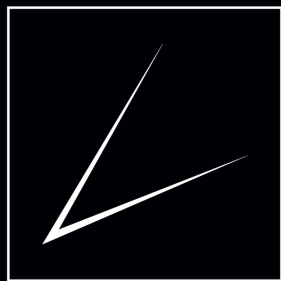

VOLTOLINA

Lighting Collection



...eredi venez



ziani della tradizione

Il marchio Voltolina è sinonimo di Vetro e Cristallo. I fratelli Voltolina, eredi veneziani di un'antica tradizione nella lavorazione del vetro, decisero nel 1984 di ampliare sforzi ed obiettivi al fine di proporre sul mercato nuovi componenti per l'illuminazione prodotti con Cristallo di elevata qualità. Una grande cura nella scelta delle materie prime, assieme ad una tecnologia innovativa, hanno permesso all'azienda di raggiungere i più alti livelli di qualità ponendola senza dubbio tra i leader mondiali di mercato. Ad oggi la sede produttiva maggiore si sviluppa su 80.000 mq, di cui 30.000 coperti, impiegando oltre 700 persone mentre sedi produttive e commerciali di minor grandezza, ma di grande importanza strategica, sono attive in molteplici paesi, quali Spagna, Romania e Tunisia. Nel corso degli anni, il punto di forza dell'azienda che era la produzione di pendaglieria per lampadari, è stato affiancato da nuove produzioni, quali l'illuminazione d'interni ed articoli per la tavola ed il regalo. Oltre al Cristallo, nel corso dell'anno 2000 sono state affiancate anche produzioni di Vetro artistico usando Vetro di Murano e Vetro Lead Free di qualità superiore. La grande flessibilità produttiva dei diversi settori dell'azienda, ha permesso negli anni di coprire sempre più numerosi segmenti di mercato. I prodotti Voltolina vengono venduti in tutto il mondo e per il cliente finale è possibile trovarli in vendita nelle show room di Venezia come in quelle di Casablanca, oppure nei migliori negozi di New York, come in quelli di Dubai. Grazie all'inventiva ed alla determinazione delle diverse forze aziendali, nel corso del 2001 è stato presentato un sistema di montaggio per i lampadari a braccia veramente rivoluzionario, chiamato Sistema Leonardo. Esso dà la possibilità di assemblare un lampadario senza dover in alcun modo lavorare sulla parte elettrica, rendendo tutto ancora più semplice di quello che può apparire. I consumatori, sempre più attenti alla facilità d'uso degli apparecchi domestici, hanno immediatamente colto la portata rivoluzionaria di questa innovazione. Dal 2009 è stata creata un'ulteriore azienda a Murano chiamata MuranoLab 1291 che realizza lampade e lampadari seguendo l'antichissima tradizione muranese.



VOLTOLINA

lighting collection (GERMAN)

Das Markenzeichen Voltolina steht für Glas und Kristall. Die Gebrüder Voltolina, die venezianischen Erben einer alten Tradition der Glasverarbeitung, beschlossen 1984, sich verstärkt und zielbewusst für neue Beleuchtungskomponenten mit Kristall höherwertiger Qualität einzusetzen. Dem Unternehmen gelang es – dank der sorgfältigen Auswahl der Rohstoffe und einer überaus innovativen Technologie – die höchsten Qualitätsniveaus zu erreichen, so dass es heute auf dem Markt ohne Zweifel zu den weltweit führenden Unternehmen zu zählen ist. Der größten Produktionsstandort weist eine Fläche von 80.000 qm auf, davon sind 30 qm bedeckt. Die Beschäftigtenzahl liegt bei über 700 Personen, während kleinere Produktionsstätten und Handelssitze, die nichtsdestoweniger von großer strategischer Bedeutung sind, in vielen Ländern der Welt wie Spanien, Rumänien, Marokko und Tunesien anzutreffen sind. Zum Kristallglas kamen im Laufe des Jahres 2000 auch Kunstglasproduktionen hinzu, bei denen Vetro di Murano und Vetro Lead Free von höherwertiger Qualität zum Einsatz kommen. Durch die enorme Herstellungsflexibilität der verschiedenen Firmenbranchen gelang es dem Unternehmen, im Laufe der Jahre immer mehr Marktsegmente abzudecken. Die Produkte Voltolina werden überall verkauft, so dass sie der Endkunde sowohl in den Verkaufsräumen Venedigs als auch in Casablanca oder gar in den besten Geschäften New Yorks wie auch in Dubai vorfinden kann, 2001 wurde ein wahrhaft revolutionäres Montagesystem für Kronleuchter namens Sistema Leonardo präsentiert: auch dies ein Ergebnis des Erfindungsreichtums und der Entschlossenheit der verschiedenen Unternehmenskräfte von Voltolina. Dieses System ermöglicht eine Lampenmontage, ohne dabei Eingriffe auf den elektrischen Teil vornehmen zu müssen. Folglich ist der Zusammenbau noch einfacher als es vielleicht scheinen mag. Die Verbraucher, die heutzutage der Anwendungsleichtigkeit der Haushaltsgeräte immer mehr Beachtung schenken, haben natürlich sofort die revolutionäre Tragweite dieser Innovation verstanden!

Im Jahr 2009 wurde in Murano die Firma “ Murano Lab 1291 gegründet, die sich ausschließlich auf traditionelle venezianischen Kronleuchter und Lampen spezialisiert.

VOLTOLINA

lighting collection (ENGLISH)

The Voltolina trademark is synonymous with Glass and Crystal. In 1984 the Voltolina brothers, heirs to a long Venetian tradition in the processing of glass, decided to diversify their manufacturing by producing high quality cut glass for lighting systems. Using their experience to source the perfect raw materials and introducing innovative new technologies they have established the company as a world leader in its field. Today the Voltolina team work from an 80.000 square meters production facility and employ over 700 people and have strategically important facilities in Spain, Rumania, Morocco and Tunisia.

In addition to cut glass, in 2000 the company began production of artistic glass in Murano and gorgeous high quality lead free crystal. This versatility and expertise has enabled the company to become a leader in a wide variety of market sectors. Customer demand for Voltolina's unique combination of design, quality and support has driven a steady increase in sales across the globe. The natural next step was to make the ranges available through a network of prestigious showrooms in cities from Venice to New York and Casablanca to Dubai. In keeping with the traditions of the company, at the turn of this century they introduced a revolutionary design for lamp assembly called “The Leonardo System” this system allows even the most elaborate lamp to be assembled without touching the electrical components, making the process quicker and safer, unsurprisingly this has become a leader in its field.

In 2009 the team decided to take a bold step and establish a business that would retrace the original traditions of Venetian glass blowing and recreate them in the “old Fashioned way”. A new company was formed based on the island of Murano called “MURANOLAB 1291” and true to the original plan it is producing Beautiful crafted pieces for clients all over the world.

VOLTOLINA

lighting collection (FRENCH)

La marque Voltolina est synonyme de Verre et de Cristal. Les frères Voltolina, héritiers vénitiens d'une ancienne tradition du travail de verre, décidèrent, en 1984, d'élargir leurs efforts et leurs objectifs afin de proposer au marché de nouveaux éléments d'éclairage en Cristal de grande qualité. Un grand soin dans le choix de matières premières, ainsi qu'une technologie novatrice, ont permis à l'entreprise d'atteindre les plus hauts niveaux de qualité et de la placer sans aucun doute parmi les leaders mondiaux du marché. Actuellement, le plus grand siège de production s'étend sur 80.000 mq, dont 30.000 couverts, et emploie plus de 700 personnes. Des sièges de production et de marketing moins importants pour les dimensions, mais de grande importance stratégique, sont en activité dans les nombreux pays tels que l'Espagne, la Roumanie, le Maroc et la Tunisie.

Au cours de l'an 2000, le Cristal a été accompagné du Verre artistique, dans des productions utilisant le Verre de Murano et le Verre Lead Free de qualité supérieure. La grande souplesse de production des différents secteurs de l'entreprise a permis, au cours des années, de couvrir des segments de marché de plus en plus nombreux. Les produits Voltolina sont vendus dans le monde entier et le client final peut les trouver en vente dans les show rooms de Venise comme dans celles de Casablanca, ou encore dans les meilleurs magasins de New York et de Dubai. Grâce à l'esprit de création et à la détermination de l'entreprise, il a été présenté en 2001 un système de montage pour les lustres à bras vraiment révolutionnaire, appelé Système Leonard. Il permet d'assembler un lustre sans aucune intervention sur la partie électrique, ce qui rend tout encore plus simple que cela ne paraît. Les consommateurs, toujours attentifs à faciliter l'emploi des appareils domestiques, ont immédiatement saisi la portée révolutionnaire de cette innovation.

De 2009 a été créée une ultérieure société à Murano, appelée Muranolab 1291, qui va réaliser de lampes et lustres en suivant l'ancienne tradition de Murano.

VOLTOLINA

lighting collection (SPANISH)

La marca Voltolina es sinónimo de Vidrio y Cristal. Los hermanos Voltolina, herederos venecianos de una antigua tradición en la fabricación de vidrio, en 1984 decidieron ampliar sus esfuerzos y objetivos, con el fin de proponer en el mercado nuevos componentes para la iluminación, producidos con Cristal de alta calidad. El gran cuidado al escoger las materias primas, junto con una tecnología innovadora, le permitieron a la empresa alcanzar los más altos niveles de calidad, situándola sin duda entre los líderes mundiales del mercado. Hoy en día la sede productiva principal se desarrolla sobre 80.000 m², de los cuales 30.000 cubiertos, y ocupa a más de 700 personas, y se encuentran activas otras sedes productivas y comerciales de dimensiones menores, pero de gran importancia estratégica, en otros países tales como España, Rumania, Marruecos y Túnez. Además del Cristal, en el 2000 se agregó también la producción de Vidrio artístico, empleando Vidrio de Murano y Vidrio libre de Plomo de alta calidad. La gran flexibilidad productiva de los diferentes sectores de la empresa, le permitió con los años abarcar cada vez más segmentos del mercado. Los productos Voltolina se venden en todo el mundo, y para el cliente final es posible encontrarlos en venta en las exhibiciones de Venecia como en las de Casablanca, o en las mejores tiendas de Nueva York o de Dubai. Gracias a la inventiva y a la determinación de las diferentes fuerzas empresariales, en el 2001 se presentó un sistema de montaje para lámparas de tipo araña verdaderamente revolucionario, llamado Sistema Leonardo. Este ofrece la posibilidad de ensamblar una lámpara sin tener que tabajar en ningún momento sobre su parte eléctrica, volviendo todo más sencillo de lo que puede aparentar. Los consumidores, cada vez más atentos a la facilidad de uso de los aparatos domésticos, de inmediato captaron el alcance revolucionario de esta innovación.

El año 2009 ha sido fundada una nueva empresa en Murano llamada Muranolab 1291, que fabrica lámparas siguiendo la antiquísima tradición muranesa.



VOLTOLINA

lighting collection (CHINESE)

Voltolina 商標是玻璃和水晶玻璃的代名詞。Voltolina 兄弟是威尼斯傳統玻璃加工行業的巨頭。他們於 1984 年決定擴大生產範圍，使用高品質的水晶玻璃，製造新的燈飾產品。對原材料的精心篩選和創新技術使公司得以生產出最高品質的產品，從而跻身這個領域的世界一流公司行列。今天，公司最大的生產基地占地 80000 平方米，其中 30000 平方米是室內場地，擁有超過 700 名員工。並且公司還在許多國家，如西班牙、羅馬尼亞和突尼斯擁有規模較小，但卻具有重要戰略意義的生產和銷售設施。多年以來，公司除了生產吊燈這樣的主力產品之外，還增加了不少新產品，如室內射燈、檯燈和禮品燈。除了水晶玻璃外，2000 年公司還開始了生產水晶玻璃，如玻璃燈罩和超高质量的吊燈。公司廣泛的產品範圍使其能夠進入多個市場領域。Voltolina 產品在全世界進行銷售，顧客在威尼斯或卡薩布蘭卡的銷售展廳，或在紐約和迪拜的精品店都能買到。2001 年公司推出了一款創新型的吊燈組裝系統，稱為“英皇請多系統”。它可以無需觸及電器部件就對吊燈進行組裝，使整個組裝過程更加快捷簡便。現在的顧客更加注重家居設備的易用簡便性了，因此這款創新產品很快便得到了顧客的青睞。自從 2009 年起，公司還另成立了一家工廠，稱為 Murano Lab 1291，根據古老的傳統工藝或工藝，專門生產穆拉諾玻璃燈具和傢俬吊燈。

VOLTOLINA

lighting collection (JAPAN)

VOLTOLINAブランドはガラス・クリスタル製品の代名詞ともいえるでしょう。ヴォルトリーナ兄弟はヴェネツィアン・ガラス製造技術の伝統を引き継ぎ、1984年から高品質クリスタル使用の新型照明部品を提供するため努力を重ねてきました。素材を厳選、最新技術を駆使することにより、VOLTOLINA社は最高品質を達成、その実現に成功し、世界的に認められるリーダー的企業の仲間入りを果たしました。本工場の敷地面積は8万平方メートル（その内、建物面積3万平方メートル）、従業員は700人を超えます。スペイン、ルーマニア、チュニジア、その他多くの国にも製造・販売支社を構えています。規模こそ本社ほど大きくありませんが、これらの支社は当企業にとって大変重要であることは間違いありません。当企業の成長につれ、代表商品であったシャンデリア用装飾ペンダントに加え、室内照明器具、食器、ギフトなど商品の幅が広がりました。2000年にはムラーノガラス・高品質の非鉛系ガラス使用の工芸ガラスがクリスタル製品に加わります。各製造部の柔軟性により着実に市場部門を拡張してきました。VOLTOLINA社製品は世界の各地で販売されており、ヴェネツィアのショールームと同じ商品がカザブランカのショールーム、ニューヨークやドバイの高級ショップでお求めいただけます。本社の各部門の創作力、たゆまぬ努力により2001年に革新的なアーム式シャンデリア用組み立てシステムLEONARDOが誕生しました。このシステムの下では電気部品を一切操作することなく、シャンデリアを組み立てることが可能で、見た目よりもさらに組立てが簡単です。家電製品の使い易さに敏感な消費者はこの新発明の価値を即座に理解しました。2009年にはムラーノ奥に新会社Murano Lab 1291が誕生。ムラーノの伝統技巧を生かしたシャンデリアやランプを製造しています。



VOLTOLINA

lighting collection (RUSSIAN)

Торговый знак «Voltolina» - это синоним Стекла и Хрусталя. Братья Вольтолина, венецианские наследники старинной традиции обработки стекла, в 1984 году объединили усилия с целью предложить на рынке новые компоненты для осветительного оборудования, произведенные из хрусталя высокого качества. Тщательность при выборе первичного сырья вместе с использованием новейших технологий позволили предприятию достичь высочайшего качества, делая его, несомненно, одним из мировых лидеров на рынке света. На сегодняшний день наиболее крупное производство располагается на площади в 80000 кв.м., 30000 кв.м. из которых составляют крытые помещения, с привлечением более 700 человек производственного персонала высокой квалификации. Производства более скромных размеров, но не меньшей стратегической важности, размещены в Испании, Румынии, Тунисе и других странах. На протяжении многих лет сильная сторона предприятия заключалась в производстве хрустальных подвесных компонентов для люстр. Впоследствии производство было диверсифицировано и ассортимент расширен за счет изделий для освещения внутреннего интерьера, изделий для сервировки стола и подарочных изделий. К производству хрусталя в 2000 году был добавлен отдел художественного стекла с применением Муранского стекла и бесвинцового стекла высшего качества. Большая производственная гибкость различных подразделений предприятия позволила в последние годы нарастить присутствие фирмы на многочисленных сегментах рынка. Изделия «Voltolina» продаются во всем мире, конечный заказчик может найти их в продаже в выставочных салонах Венеции, также как и в салонах Касабланки или же в лучших магазинах Нью-Йорка, Москвы и Дубаи. Благодаря изобретательности и настойчивости технического отдела предприятия, в 2001 году была представлена новейшая система сборки люстр под названием «Система Леонардо». Система дает возможность собирать люстру без необходимости работы с электрической частью, значительно упрощая весь процесс сборки. Потребители, все более внимательные к простоте и удобству пользования бытовыми приборами, немедленно приняли революционную важность этого новшества. В 2009 году «Voltolina» создала еще одну дочернюю компанию непосредственно на острове Мурано - МураноЛаб1291, которая изготавливает люстры, строго соблюдая старейшие традиции обработки Муранского стекла.

VOLTOLINA

lighting collection (ARAB)

العلامة التجارية "Voltolina" هي مرادف للإبداع والتميز. في عام 1984 قرر الاخوة "Voltolina"، الورثة الفينيسيون كتقليد القديم الخاص بأصناف الزجاج، توسيع نطاق الجهود والأهداف من أجل تزويد السوق بمكونات جديدة للإضاءة مصنوعة من البلور. على الجودة: قد مكنت العجلة الكبيرة في اختيار المواد الأولية جنباً إلى جنب مع التكنولوجيا المتكيفة، الشركة من الوصول إلى أعلى مستويات الجودة ووضعتها بدون شك بين الشركات الرائدة العالمية الموجودة في السوق. حتى الآن يسلو أكبر مقر إنتاجي على مساحة تبلغ 80000 متر مربع منها 30000 مغطاة. ويعمل به أكثر من 700 شخص، بينما تُعد الممرات الإنتاجية والتجارية الأكل حاضمة، ولكن ذات الأهمية الإستراتيجية الكبيرة، نشطة في العديد من البلدان مثل اسبانيا ورومانيا وتونس. على مر السنين كانت تصاحب نقطة قوة الشركة التي تتمثل في إنتاج القطرات المتكيفة للثريات، منتجات جديدة مثل إضاءة الأمان الداخلية والعناصر الخاصة بالمطالعة والهدايا. بالإضافة إلى تطور التصنيع أيضاً، خلال عام 2000، منتجات زجاج قسي باستخدام زجاج "Murano" وزجاج "Lead Free" على الجودة. على مر السنين سمحت المرونة الإنتاجية لقطاعات الشركة المطلقة بتغطية أقسام السوق المتعددة دائماً بشكل أكبر. أتاح منتجات شركة "Voltolina" في جميع أنحاء العالم ويمكن للعميل النهائي العثور عليها معروضة للبيع في صالات العرض في فينيسيا وكذلك في صالات العرض بالدار البيضاء أو في المحلات الكبرى بنيويورك وكذلك المحلات الكبرى في دبي. بفضل الابتكار والتصميم الخاص بمختلف القوى بالشركة تم خلال عام 2001 تقديم نظام تركيب للثريات ذات الزجاج وهو يعدّ ثورياً جدياً، ويُطلق عليه نظام "Leonardo". إنه يعنى إمكانية تركيب الثريا دون وجود العمل بأي شكل من الأشكال على الجزء الكهربائي وبذلك يجعل كل شيء أكثر سهولة مما قد يبدو. ارتك على الفور المستهلكون، العرضيون بشكل أكثر تزايداً على سهولة استخدام الأجهزة المنزلية، القدرة الثورية لهذا الابتكار. منذ عام 2009 تم إنشاء شركة أخرى في "Murano" تسمى "Muranolab 1291" وهي تقوم بإنتاج إضاءة وثريرات متبعة تقليد القديم جداً الخاص بـ "Murano".



SISTEMA LEONARDO



Voltolina è orgogliosa di presentare il nuovo sistema per l'assemblaggio dei lampadari. Esso consiste nella possibilità di collegare il corpo centrale pre-cablato ai braccetti, in una sola operazione, della durata di un "click". Il sistema Leonardo è brevettato oltre ad essere certificato seguendo le regole CE IMQ e UL. Il tempo di assemblaggio e pulizia decresce notevolmente, mentre la sicurezza raggiunge il massimo livello. Il cliente finale è il maggior beneficiario di questo sistema; finalmente è ora possibile acquistare un lampadario di estrema bellezza, senza faticare per il montaggio.

Voltolina präsentiert stolz den neuen Kronleuchter Montage-System. Das gibt die Möglichkeit die vorinstallierten Arme beim Aufbau einfach mit dem Körper zu montieren, mit dem Geräusch eines "Klicks". Sistema Leonardo ist sowie als CE, IMQ zertifiziert und UL-Regeln patentiert. Montage und Reinigung wird dem entsprechend zeitlich gekürzt, während das Sicherheitsniveau erreicht höchstem Niveau. Nun ist es endlich möglich, die Schönheit eines äußerest stilvollen Lüstern zu genießen, ohne lästiges Zusammenbauen.

Voltolina is proud to present our new chandelier assembly system. It enables the user to connect the arms to the pre-wired central body, in one operation, with just one "click". 'Sistema Leonardo' is patented as well as being certified as meeting EU, IMQ and UL standards. Assembly and cleaning time is considerably decreased, at the same time as maximising safety. The customer is the main beneficiary of the system, because now it is finally possible to have the beauty of an extremely stylish chandelier without the difficulty of assembling it.

Voltolina est fière de vous présenter le nouveau système pour l'assemblage des lustres. celui-ci consiste en la possibilité de connecter le corps central précâblé aux bras, en une seule opération de la durée d'un click. le système Leonardo est breveté en plus d'être certifié obéissant aux normes CE IMQ et UL. les temps d'assemblage et de nettoyages sont considérablement réduits tandis que la sécurité atteint son maximum. Le client final est le principal bénéficiaire de ce système: il est enfin possible d'acquérir d'une extrême beauté sans avoir de difficulté à le monter.

Voltolina está orgullosa de presentar un nuevo sistema de ensamblaje de lámparas. Este consiste en la posibilidad de conectar el cuerpo central pre-cableado a los brazos, en una sola operación, de la duración de un "click". El sistema Leonardo está patentado y certificado siguiendo las regulaciones CE, IMQ e UL. El tiempo de montaje y de limpieza se reduce notablemente, mientras que la seguridad alcanza el máximo nivel. El cliente final es el más beneficiado de éste sistema, finalmente ahora es posible adquirir una lámpara de belleza extrema, sin preocuparse por el montaje.

Voltolina 荣誉推出新型枝形吊灯组装系统。使用此系统，只需一个简单的操作步骤。“咔嚓”一声，即可将灯臂连接到事先接好线的中央灯体上。“莱昂纳多系统”是一个专利产品。并且通过了 CE、IMQ 和 UL 认证。可大大减少组装和清洁的时间。同时达到了最高的安全水平。顾客是此系统最大的受惠者：现在终于可以拥有极具风格的华丽吊灯，同时又不用费心费力地去组装了。

ジャンデリア組み立ての新システムをVOLTOLINA社がご紹介します。これは、配線済みの本体を複数アームにたった一回のクリック操作でつなげるシステムです。LEONARDOシステムはCE、IMQ、ULの各電気規格に基づいた認証を取得、特許取得。組み立て・洗浄にかかる時間を大幅に減少した上、最大の安全性を誇ります。これはお客様のことを第一に考えたシステムです。面倒な取り付けに悩まされることなく美しいシャンデリアをご購入いただけます。

Компания Вольтолина с гордостью представляет новую систему сборки люстр. Эта система позволяет соединять рожки к уже оснащенной проводкой центральной части одним простым движением за считанные секунды. Система Леонардо была запатентована и прошла сертификацию CE, IMQ и UL. Благодаря этому новшеству, мы значительно сокращаем время на сборку, облегчаем уход за люстрой и в тоже время предлагаем максимальный уровень безопасности. Несомненно, конечный потребитель получает двойную выгоду: наконец, у него появляется возможность повесить современную, стильную, красивую люстру, не приложив при этом никаких усилий при сборке.

"تفخر شركة Voltolina بتقديم النظام الجديد لتثبيت اللامبات. يتشكل هذا النظام في إمكانية توصيل الجسم المركزي السابق للتميزه بالكابلات بالأذرع في عملية واحدة منتهيا بلع "نقرة". نظام "Leonardo" حاصل على براءة اختراع بالإضافة إلى كونه شمسق وهذا التوافق مع المواصفات CE وIMQ وUL. يقل زمن التركيب والتنظيف بشكل ملحوظ بينما يصل الأمان إلى أعلى مستوياته. العميل النهائي هو المستفيد الأكبر من هذا النظام، وأخيرا أصبح الآن ممكنا شراء ذريا غاية في الجمال دون التعور بالتعب في التركيب".



CONTEMPORARY

lighting collection 12



Babylon	pag 14
Dalì	pag 22
Mirò	pag 28
Cascade	pag 34
Rainbow	pag 38
DNA	pag 46
Silk	pag 50
Reflex	pag 58
Golf	pag 62

GLAM&GLASS

lighting collection 66



Canaletto	pag 68
Laguna	pag 74
Ca' d'Oro	pag 86
Bach	pag 94
Alvise	pag 100
Barnaba	pag 106
San Marco	pag 112
Doge	pag 116
Flora	pag 124

CRISTALLO

lighting collection 128



Alicante	pag 130
Barcelona	pag 136
Dream	pag 142
Erika	pag 152
Granada	pag 158
Serenade	pag 164
Valencia	pag 170
Temptation	pag 176
Toledo	pag 182
Siviglia	pag 188
Vienna	pag 194
Vienna plus	pag 200

CLASSICO

lighting collection 206



Amsterdam	pag 208
Beethoven	pag 214
Galaxy	pag 220
Mosca	pag 224
New Orleans	pag 228
Osaka	pag 234
Pegaso	pag 240
Roma	pag 246
Settat	pag 252
Twister	pag 260
Salisburgo	pag 268
Graz	pag 274
Innsbruck	pag 278
Lienz	pag 282
Paralumi	pag 288

CONTEMPORARY

lighting collection



Babylon	pag 14
Dalì	pag 22
Mirò	pag 28
Cascade	pag 34
Rainbow	pag 38
DNA	pag 46
Silk	pag 50
Reflex	pag 58
Golf	pag 62

BABYLON

design: Brian Rasmussen



Babylon lampadario 6+6L
Ø 65 cm - H 72 cm
12 x E14 40W

Babylon lampadario 6+6+6L
Ø 65 cm - H 92 cm
18 x E14 40W



BABYLON

design: Brian Rasmussen



Babylon lampadario 12L
Ø 65 cm - H 52 cm
12 x E14 40W

Babylon lampadario 8L
Ø 65 cm - H 52 cm
8 x E14 40W



BABYLON

design: Brian Rasmussen



Babylon lampadario 6L
Ø 65 cm - H 52 cm
6 x E14 40W

Babylon lampadario 6+6L
Ø 65 cm - H 72 cm
12 x E14 40W



BABYLON

design: Brian Rasmussen



Babylon parete 3L
L 49 cm - H 36 cm - SP 28 cm
3 x E14 40W



Babylon parete 2L
L 31 cm - H 36 cm - SP 22 cm
2 x E14 40W

BABYLON

design: Brian Rasmussen



Collezione di lampade in stile Moderno, in cristallo soffiato e lavorato a mano. Montatura in metallo con finitura nichel o oro.

Lamp collection in Modern style in handmade blown glass. Nickel or gold metal frame.

Luminaire de style Moderne, en cristal soufflé travaillé à la main. Monture en métal, finition nickel ou dorée.

Colección de lámparas de estilo moderno, de cristal soplado y elaborado a mano. Armazón de metal con acabado en níquel o baño de oro 24 KT.

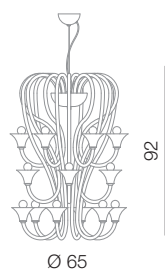

Babylon lampadario 18L (6+6+6)
Ø 65 cm - H 92 cm
18 x E14 40W

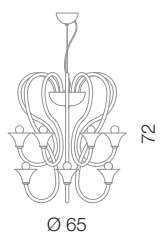

Babylon lampadario 12L (6+6)
Ø 65 cm - H 72 cm
12 x E14 40W

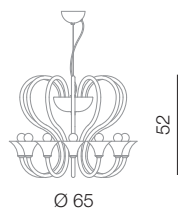

Babylon lampadario 12L
Ø 65 cm - H 52 cm
12 x E14 40W

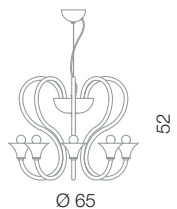

Babylon lampadario 8L
Ø 65 cm - H 52 cm
8 x E14 40W



Babylon lampadario 6L
Ø 65 cm - H 52 cm
6 x E14 40W

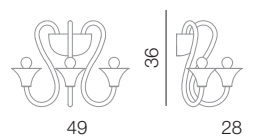

Babylon parete 3L
L 49 cm - H 36 cm - SP 28 cm
3 x E14 40W

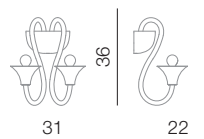

Babylon parete 2L
L 31 cm - H 36 cm - SP 22 cm
2 x E14 40W



DALÍ



Dalí lampadario 12L
Ø 76 cm - H 57 cm
12 x E14 40W

Dalí lampadario 8L
Ø 76 cm - H 57 cm
8 x E14 40W



DALÍ



Dalí lampadario 6L
Ø 69 cm - H 52 cm
6 x E14 40W

Dalí parete 3L
L 57 cm - H 22 cm - SP 35 cm
3 x E14 40W





Dalí parete 2L
L 34 cm - H 22 cm - SP 30 cm
2 x E14 40W



Dalí tavolo 1L
Ø 20 cm - H 42 cm
1 x E14 40W

DALÍ



Collezione di lampade in cristallo 24% PbO soffiato e lavorato a mano. Disponibili con montatura dorata 24 KT o nichel. Braccetti ad innesto rapido "Sistema Leonardo".

Lighting collection with hand-made blown lead crystal 24% PbO, available with 24 KT gold or nickel plated frame, arms with quick connect "Sistema Leonardo".

Collection des lustres en cristal au 24% Pbo. Disponibles avec finition dorée ou nickelée, soufflé et travaillé à la main. Les bras utilisent le "Sistema Leonardo".

Colección de lámparas en cristal al 24% de PbO, disponible en baño de oro 24 KT o níquel soplado a mano, brazos con conexión rápida "Sistema Leonardo".

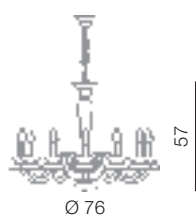

Dalí lampadario 12L
Ø 76 cm - H 57 cm
12 x E14 40W

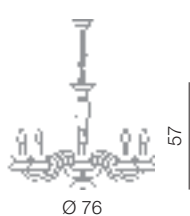

Dalí lampadario 8L
Ø 76 cm - H 57 cm
8 x E14 40W



Dalí lampadario 6L
Ø 69 cm - H 52 cm
6 x E14 40W

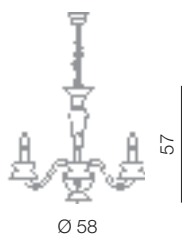

Dalí lampadario 4L
Ø 58 cm - H 57 cm
4 x E14 40W

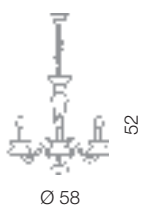

Dalí lampadario 3L
Ø 58 cm - H 52 cm
3 x E14 40W



Dalí parete 3L
L 57 cm - H 22 cm - SP 35 cm
3 x E14 40W

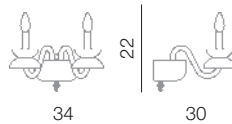

Dalí parete 2L
L 34 cm - H 22 cm - SP 30 cm
2 x E14 40W



Dalí tavolo 1L
Ø 20 cm - H 42 cm
1 x E14 40W

MIRÓ



Miró lampadario 8L
Ø 81 cm - H 66 cm
8 x E14 40W

Miró lampadario 6L
Ø 61 cm - H 58 cm
6 x E14 40W



MIRÓ



Miró lampadario 12L
Ø 81 cm - H 66 cm
12 x E14 40W





Miró parete 2L
L 31 cm - H 27 cm - SP 28 cm
2 x E14 40W



Miró tavolo 1L
Ø 15 cm - H 36 cm
1 x E14 40W

MIRÓ



Collezione di lampade in cristallo 24% PbO soffiato e lavorato a mano. Disponibili con montatura dorata 24 KT o nichel. Braccetti ad innesto rapido "Sistema Leonardo".

Lighting collection with hand-made blown lead crystal 24% PbO, available with 24 KT gold or nickel plated frame, arms with quick connect "Sistema Leonardo".

Collection des lustres en cristal au 24% Pbo soufflé et travaillé à la main. Disponibles avec finition dorée ou nickelée. Les bras utilisent le "Sistema Leonardo".

Colección de lámparas en cristal al 24% de PbO soplado a mano. Disponible en baño de oro 24 KT o níquel soplado a mano. Brazos con conexión rápida "Sistema Leonardo".

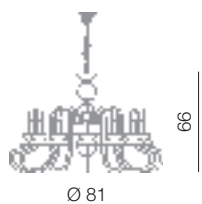

Miró lampadario 12L
Ø 81 cm - H 66 cm
12 x E14 40W

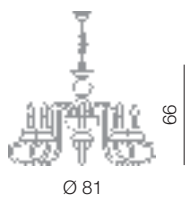

Miró lampadario 8L
Ø 81 cm - H 66 cm
8 x E14 40W

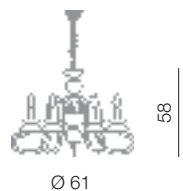

Miró lampadario 6L
Ø 61 cm - H 58 cm
6 x E14 40W

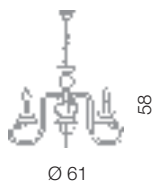

Miró lampadario 4L
Ø 61 cm - H 58 cm
4 x E14 40W



Miró parete 3L
L 50 cm - H 27 cm - SP 34 cm
3 x E14 40W



Miró parete 2L
L 31 cm - H 27 cm - SP 28 cm
2 x E14 40W

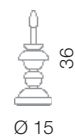

Miró tavolo 1L
Ø 15 cm - H 36 cm
1 x E14 40W

CASCADE



Cascade lampadario Ø 40 cm
Ø 40 cm - H 70 cm
5 x E14 40W

Cascade lampadario Ø 60 cm
Ø 60 cm - H 75 cm
9 x E14 40W



CASCADE



Cascade parete 2L
L 20 cm - H 19 cm - SP 12 cm
2 x E14 40W



Cascade tavolo 1L
Ø 19 cm - H 23 cm
1 x E27 40W

CASCADE

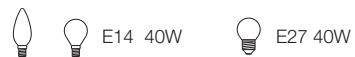

Collezione di lampade con cristalli al 24% di PbO e disponibili con montatura dorata 24 KT o nichel.

Lighting collection with lead crystal 24% PbO pendants, available with 24 KT gold or nickel plated frame.

Collection des lustres avec cristaux au 24% de PbO et disponibles avec finition dorée ou nickelée.

Colección de lámparas con cristal al 24% de PbO, disponible en baño de oro 24 KT o níquel.



Cascade lampadario Ø 60 cm
Ø 60 cm - H 75 cm
9 x E14 40W

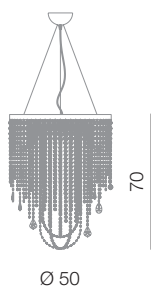

Cascade lampadario Ø 50 cm
Ø 50 cm - H 70 cm
7 x E14 40W

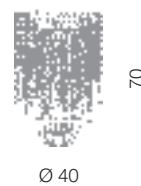

Cascade lampadario Ø 40 cm
Ø 40 cm - H 70 cm
5 x E14 40W

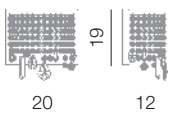

Cascade parete 2L
L 20 cm - H 19 cm - SP 12 cm
2 x E14 40W

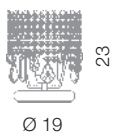

Cascade tavolo 1L
Ø 19 cm - H 23 cm
1 x E27 40W



RAINBOW



Rainbow lampadario ovale 6L
L 91 x 35 cm - H 26 cm
6 x G9 60W

Rainbow lampadario ovale 6L
L 91 x 35 cm - H 26 cm
6 x G9 60W



RAINBOW



Rainbow lampadario rotondo 6L
Ø 50 cm - H 26 cm
6 x G9 60W

Rainbow lampadario rotondo 6L
Ø 50 cm - H 26 cm
6 x G9 60W



Rainbow terra rotonda 8L
Ø 30 cm - H 165 cm
8 x G9 60W



RAINBOW



Rainbow lampadario quadrato 6L
L 50 x 50 cm - H 26 cm
6 x G9 60W



Rainbow terra ovale 8L
Ø 30 cm - H 165 cm
8 x G9 60W



Rainbow terra rotonda 8L
Ø 30 cm - H 165 cm
8 x G9 60W



Rainbow terra quadrata 8L
Ø 30 cm - H 165 cm
8 x G9 60W

RAINBOW



Rainbow parete quadrata 2L
L 22 cm - H 28 cm - SP 13 cm
2 x G9 60W



Rainbow parete rotonda 2L
L 22 cm - H 28 cm - SP 11 cm
2 x G9 60W

RAINBOW



Collezione di lampade in stile Contemporaneo con cristalli al 24% di PbO, disponibile nei colori cristallo, cristallo/ambra, cristallo/nero e cristallo/rosso. Montatura in metallo con finitura nichel.

Lamp collection in Contemporary style with crystals 24% PbO, available in crystal, crystal/amber, crystal/black and crystal/red colours. Nickel metal frame.

Luminaire de style Contemporain en cristal de 24% du PbO, disponibles dans les couleurs: cristal, cristal/ambre, cristal/noir et cristal/rouge. Monture in métal, finition nickel.

Colección de lámparas de estilo contemporáneo de cristal (con 24% PbO), disponibles en los siguientes colores: cristal, cristal/ámbar, cristal/negro y cristal/rojo. Armazón de metal con acabado en níquel.

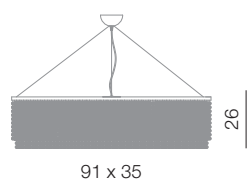

Rainbow lampadario ovale 6L
L 91 x 35 cm - H 26 cm
6 x G9 60W

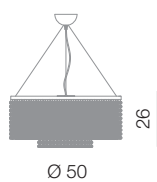

Rainbow lampadario rotondo 6L
Ø 50 cm - H 26 cm
6 x G9 60W

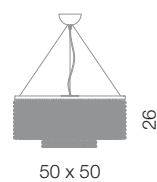

Rainbow lampadario quadrato 6L
L 50 x 50 cm - H 26 cm
6 x G9 60W

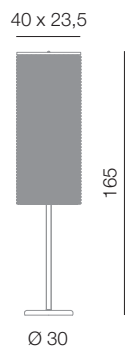

Rainbow terra ovale 8L
Ø 30 cm - H 165 cm
8 x G9 60W

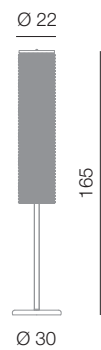

Rainbow terra rotonda 8L
Ø 30 cm - H 165 cm
8 x G9 60W

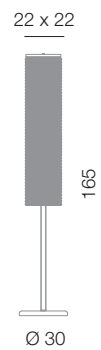

Rainbow terra quadrata 8L
Ø 30 cm - H 165 cm
8 x G9 60W

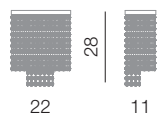

Rainbow parete rotonda 2L
L 22 cm - H 28 cm - SP 11 cm
2 x G9 60W

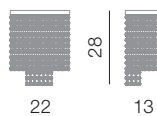

Rainbow parete quadrata 2L
L 22 cm - H 28 cm - SP 13 cm
2 x G9 60W

DNA

design: Brian Rasmussen



DNA lampadario Ø 70 cm
L 70 x 40 cm - H 60 cm
8 x E14 40W

DNA lampadario Ø 50 cm
L 50 x 30 cm - H 45 cm
6 x E14 40W

DNA terra 6L
L 50 x 30 cm - H 180 cm
6 x E14 40W



DNA

design: Brian Rasmussen



parete 2L
L 30 cm - H 25 cm - SP 25 cm
2 x E14 40W

tavolo 2L
L 30 x 20 cm - H 37 cm
2 x E14 40W

DNA

design: Brian Rasmussen



Collezione di lampade in stile Contemporaneo con cristalli al 24% di PbO. Montatura in metallo con finitura nichel.

Lamp collection in Contemporary style with lead crystals 24% PbO. Nickel metal frame.

Luminaire de style Contemporain en cristal de 24% du PbO. Monture en métal, finition nickel.

Colección de lámparas de estilo contemporáneo de cristal (24% PbO). Armazón de metal con acabado en níquel.

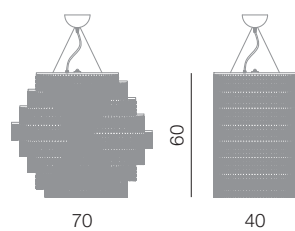

DNA lampadario Ø 70 cm
L 70 x 40 cm - H 60 cm
8 x E14 40W

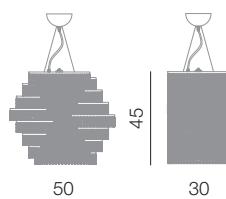

DNA lampadario Ø 50 cm
L 50 x 30 cm - H 45 cm
6 x E14 40W

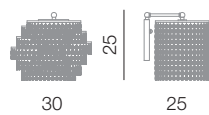

DNA parete 2L
L 30 cm - H 25 cm - SP 25 cm
2 x E14 40W

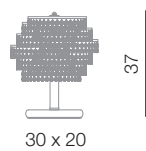

DNA tavolo 2L
L 30 x 20 cm - H 37 cm
2 x E14 40W

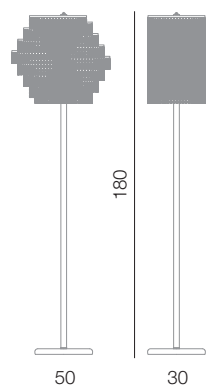

DNA terra 6L
L 50 x 30 cm - H 180 cm
6 x E14 40W

SILK



Silk **Alpha** lampadario 70 cm
L 70 cm - H 88 cm - SP 37 cm
6 x G9 40W

Silk Alpha lampadario 100 cm
L 100 cm - H 98 cm - SP 53 cm
8 x G9 40W



SILK



Silk **Delta** lampadario 100 cm
L 100 cm - H 92 cm - SP 35 cm
6 x G9 40W

Silk **Delta** lampadario 70 cm
L 70 cm - H 84 cm - SP 25 cm
4 x G9 40W



SILK



Silk **Gamma** lampadario Ø 100 cm
L 100 cm - H 105 cm - SP 83 cm
8 x G9 40W

Silk **Gamma** lampadario Ø 70 cm
L 70 cm - H 105 cm - SP 57 cm
6 x G9 40W

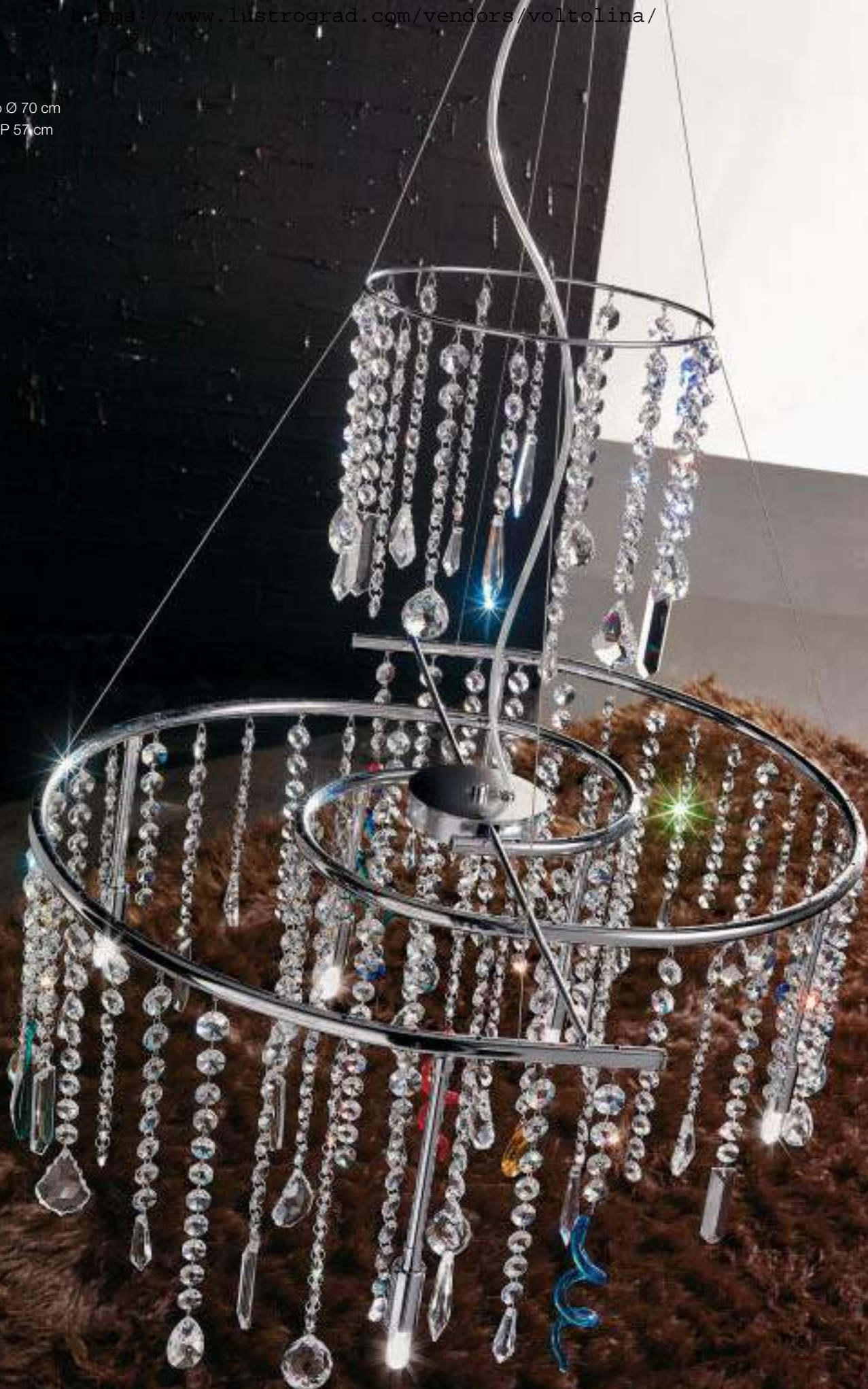



Silk parete 2L
L 27 cm - H 27 cm - SP 18 cm
2 x G9 40W



Silk tavolo 3L
Ø 23 cm - H 29 cm
3 x G9 40W

SILK



Collezione di lampade con cristalli al 24% PbO, disponibile nella variante con pendenti colorati in vetro di Murano lavorati al "Lume". Montatura con finitura nichel.

Lighting collection with lead crystal 24% PbO pendants, available both with clear crystal and coloured hand-made Murano glass. Nickel metal frame.

Collection des lustres avec cristaux au 24% PbO disponibles aussi avec pendants en verre de Murano travaillés à la main. Finition nickelée.

Colección de lámparas con cristal al 24% de PbO, disponible en cristal de Murano transparente y en colores. Acabado en níquel.

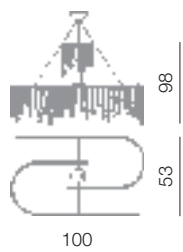

Silk **Alpha** lampadario 100 cm
L 100 cm - H 98 cm - SP 53 cm
8 x G9 40W

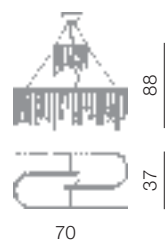

Silk **Alpha** lampadario 70 cm
L 70 cm - H 88 cm - SP 37 cm
6 x G9 40W



Silk **Alpha** lampadario 50 cm
L 50 cm - H 78 cm - SP 37 cm
4 x G9 40W

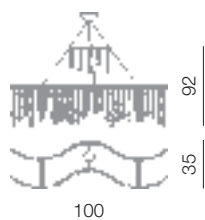

Silk **Delta** lampadario 100 cm
L 100 cm - H 92 cm - SP 35 cm
6 x G9 40W



Silk **Delta** lampadario 70 cm
L 70 cm - H 84 cm - SP 25 cm
4 x G9 40W



Silk **Delta** lampadario 50 cm
L 50 cm - H 77 cm - SP 20 cm
4 x G9 40W

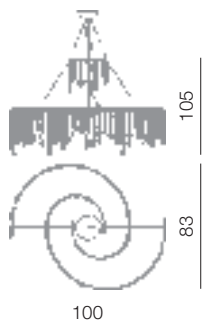

Silk **Gamma** lampadario Ø 100 cm
L 100 cm - H 105 cm - SP 83 cm
8 x G9 40W

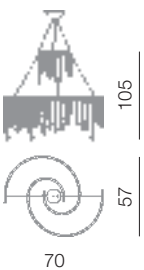

Silk **Gamma** lampadario Ø 70 cm
L 70 cm - H 105 cm - SP 57 cm
6 x G9 40W

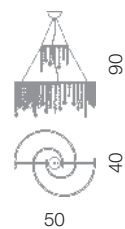

Silk **Gamma** lampadario Ø 50 cm
L 50 cm - H 90 cm - SP 40 cm
4 x G9 40W

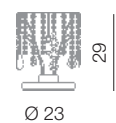

Silk tavolo 3L
Ø 23 cm - H 29 cm
3 x G9 40W

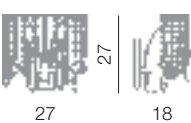

Silk parete 2L
L 27 cm - H 27 cm - SP 18 cm
2 x G9 40W



REFLEX

design: Alessandro Lenarda



Reflex sospensione Ø 45 cm
Ø 45 cm - H 24 cm
1 x E27 100W

REFLEX

design: Alessandro Lenarda

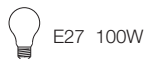

Collezione di lampade in stile Moderno, diffusore in vetro soffiato e lavorato a mano bianco latte sfumato, con all'interno ottagononi in cristallo al 24% di PbO disponibili nei colori cristallo, cristallo/ambra, cristallo/nero, cristallo/rosso, cristallo/verde, cristallo/acquamare e cristallo/ametista. Montatura in metallo cromato.

Lamp collection in handmade blown glass, milk faded white with crystal octogons 24% PbO available in the following colours: crystal, crystal/amber, crystal/black and crystal/red colours. Chrome metal frame.

Luminaire de style Moderne, diffuseur en verre soufflé et travaillé à la main, de couleur blanc lait nuance, avec à l'intérieur des octagons en cristal de 24% du pbo, disponibles dans le couleurs crystal, crystal/amber, crystal/noir, crystal/rouge, crystal/vert, crystal/aigue-marine et crystal/amethyste. Monture en Métal chromé.

Lámpara de estilo moderno, difusor en vidrio soplado y trabajado a mano, color blanco leche matizado, con octágonos de cristal (24% PbO) en la parte interna disponibles en los colores: cristal, cristal/ámbar, cristal/negro, cristal/rojo, cristal/verde, cristal/aguamarina y cristal/amatista. Estructura en metal cromado.

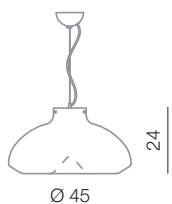

Reflex sospensione Ø 45 cm
Ø 45 cm - H 24 cm
1 x E27 100W



Cristallo / nero



Cristallo / rosso



Cristallo / ambra



Cristallo



Cristallo / verde



Cristallo / acquamare



Cristallo / ametista



REFLEX

design: Alessandro Lenarda



Reflex sospensione Ø 15 cm
Ø 15 cm - H 24 cm
1 x E14 60W

REFLEX

design: Alessandro Lenarda

 E14 60W



Collezione di lampade in stile Moderno, diffusore in vetro soffiato e lavorato a mano bianco latte sfumato, con all'interno ottagononi in cristallo al 24% di PbO disponibili nei colori cristallo, cristallo/ambra, cristallo/nero, cristallo/rosso, cristallo/verde, cristallo/acquamare e cristallo/ametista. Montatura in metallo cromato.

Lamp collection in handmade blown glass, milk faded white with crystal octogons 24% PbO available in the following colours: crystal, crystal/amber, crystal/black and crystal/red colours. Chrome metal frame.

Luminaire de style Moderne, diffuseur en verre soufflé et travaillé à la main, de couleur blanc lait nuance, avec à l'intérieur des octagons en cristal de 24% du pbo, disponibles dans le couleurs crystal, crystal/amber, crystal/noir, crystal/rouge, crystal/vert, crystal/aigue-marine et crystal/amethyste. Monture en Métal chromé.

Lámpara de estilo moderno, difusor en vidrio soplado y trabajado a mano, color blanco leche matizado, con octágonos de cristal (24% PbO) en la parte interna disponibles eb los colores: cristal, cristal/ámbar, cristal/negro, cristal/rojo, cristal/verde, cristal/aguamarina y cristal/amatista. Estructura en metal cromado.

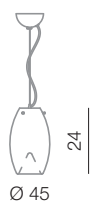

Reflex sospensione Ø 15 cm
Ø 15 cm - H 24 cm
1 x E14 60W



Cristallo / nero



Cristallo / rosso



Cristallo / ambra



Cristallo



Cristallo / verde



Cristallo / acquamare



Cristallo / ametista



GOLF

design: Alessandro Lenarda



Golf sospensione Ø 25 cm
L 23 cm - Ø 25 cm - H max 120 cm
1 x E27 75W

Golf sospensione Ø 40 cm
L 38 cm - Ø 40 cm - H max 120 cm
2 x E27 75W

Golf parete 1L
L 18 cm - Ø 20 cm - SP 20 cm
1 x E27 60W



GOLF

design: Alessandro Lenarda



Golf terra 1L
L 56 x 40 cm - Ø 25 cm - H 198 cm
1 x E27 75W

Golf tavolo 1L
L 26 x 19 cm - Ø 20 cm - H 48 cm
1 x E27 60W

GOLF

design: Alessandro Lenarda

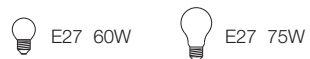

Collezione di lampade in stile Moderno, diffusore in vetro soffiato e lavorato a mano, colore bianco latte. Montatura in metallo cromato.

Lamp collection in Modern style in handmade blown glass, milk white colour. Chrome metal frame.

Luminaire de style Moderne, diffuseur en verre soufflé et travaillé à la main, de couleur blanc lait. Monture en métal chromé.

Colección de lámparas de estilo moderno, globo de vidrio soplado y elaborado a mano, color blanco leche. Estructura de metal con acabado en cromo.

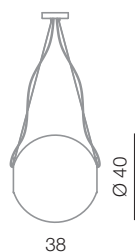

Golf sospensione Ø 40 cm
L 38 cm - Ø 40 cm - H max 120 cm
2 x E27 75W

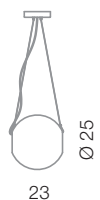

Golf sospensione Ø 25 cm
L 23 cm - Ø 25 cm - H max 120 cm
1 x E27 75W

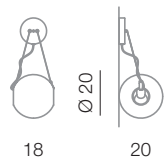

Golf parete 1L
L 18 cm - Ø 20 cm - SP 20 cm
1 x E27 60W

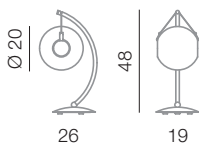

Golf tavolo 1L
L 26 x 19 cm - Ø 20 cm - H 48 cm
1 x E27 60W

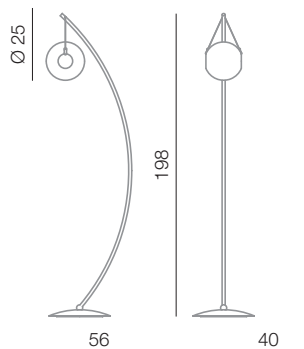

Golf terra 1L
L 56 x 40 cm - Ø 25 cm - H 198 cm
1 x E27 75W

GLAM&GLASS

lighting collection



Canaletto	pag 68
Laguna	pag 74
Ca' d'Oro	pag 86
Bach	pag 94
Alvise	pag 100
Barnaba	pag 106
San Marco	pag 112
Doge	pag 116
Flora	pag 124



CANALETTO



Canaletto lampadario 12L
Ø 104 cm - H 59 cm
12 x E14 40W

Canaletto lampadario 8L
Ø 84 cm - H 59 cm
8 x E14 40W



CANALETTO



Canaletto lampadario 6L
Ø 84 cm - H 59 cm
6 x E14 40W



CANALETTO



Canaletto parete 2L
L 40 cm - H 32 cm - SP 32 cm
2 x E14 40W



Canaletto tavolo 1L
Ø 20 cm - H 50 cm
1 x E14 40W

CANALETTO

E14 40W



Collezione di lampade in stile Classico, in vetro soffiato e lavorato a mano, colore bianco con inserti neri. Montatura in metallo con finitura nichel.

Lamp collection in Classic style in handmade blown glass, white colour with black inserts. Nickel metal frame.

Luminaire de style Classique, en verre soufflé et travaillé à la main, de couleur blanc avec des détails noirs. Monture en métal, finition nickel.

Colección de lámparas de estilo clásico, de vidrio soplado y elaborado a mano, color blanco con inserciones de vidrio de color negro. Armazón de metal con acabado en níquel.

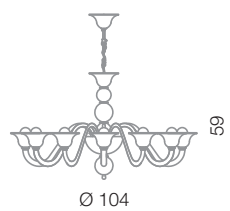

Canaletto lampadario 12L
Ø 104 cm - H 59 cm
12 x E14 40W

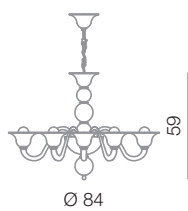

Canaletto lampadario 8L
Ø 84 cm - H 59 cm
8 x E14 40W

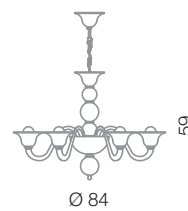

Canaletto lampadario 6L
Ø 84 cm - H 59 cm
6 x E14 40W



Canaletto parete 2L
L 40 cm - H 32 cm - SP 32 cm
2 x E14 40W



Canaletto tavolo 1L
Ø 20 cm - H 50 cm
1 x E14 40W

LAGUNA



Laguna lampadario 8+4L
Ø 80 cm - H 80 cm
12 x E14 40W

Laguna lampadario 8+4L
Ø 80 cm - H 80 cm
12 x E14 40W



LAGUNA



Laguna lampadario 6L
Ø 73 cm - H 72 cm
6 x E14 40W

Laguna lampadario 8L
Ø 80 cm - H 80 cm
8 x E14 40W



LAGUNA



Laguna lampadario 12+6L
Ø 80 cm - H 80 cm
18 x E14 40W

Laguna piantana 6L
Ø 80 cm - H 170 cm
6 x E14 40W

Laguna parete 2L
L 36 cm - H 32 cm - SP 32 cm
2 x E14 40W

Laguna tavolo 1L
Ø 17 cm - H 37 cm
1 x E14 40W



LAGUNA



Laguna lampadario 6L BB
Ø 80 cm - H 80 cm
6 x E14 40W

Laguna lampadario 8L BB
Ø 89 cm - H 80 cm
8 x E14 40W



LAGUNA





Laguna plafoniera 8L
Ø 77 cm - H 42 cm
8 x E14 40W

Laguna plafoniera 6L
Ø 77 cm - H 42 cm
6 x E14 40W



LAGUNA

  E14 40W



Collezione di lampade in stile Veneziano contemporaneo, con vetro soffiato e lavorato a mano, disponibili nei colori cristallo, rosso, nero e bianco con montatura nichelata; ambar e cristallo/oro con montatura dorata. Braccetti ad innesto rapido "Sistema Leonardo".

Venetian style chandeliers, in hand-made blown glass, available in clear crystal, red, black and white colours with nickel frame; amber and crystal-gold leaf colours available with 24 KT gold frame. Arms with quick connect "Sistema Leonardo".

Collection des lustres en style Vénitien contemporain, avec verre soufflé et travaillé à la main, disponibles en cristal, rouge, noir et blanc avec finition nickelée, et en ambré et cristal/oro avec finition dorée. Les bras utilisent le "Sistema Leonardo".

Colección de lámparas de estilo Veneciano contemporáneo, con cristal soplado a mano, disponible en color transparente, rojo negro y blanco con acabado níquel; ambar y cristal/oro con acabado dorado. Brazos con conexión rápida "Sistema Leonardo".





Laguna lampadario 12+6L
Ø 80 cm - H 80 cm
18 x E14 40W

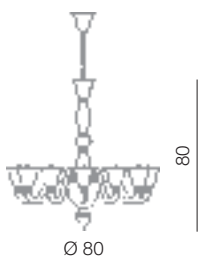

Laguna lampadario 12L
Ø 80 cm - H 80 cm
12 x E14 40W

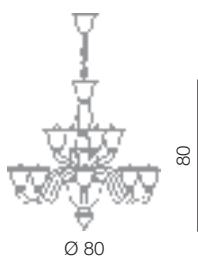

Laguna lampadario 8+4L
Ø 80 cm - H 80 cm
12 x E14 40W

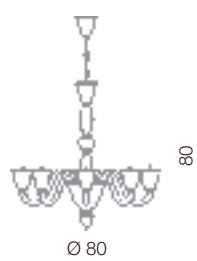

Laguna lampadario 8L
Ø 80 cm - H 80 cm
8 x E14 40W



Laguna lampadario 6L
Ø 73 cm - H 72 cm
6 x E14 40W

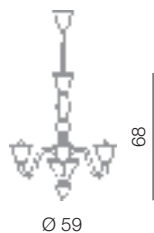

Laguna lampadario 4L
Ø 59 cm - H 68 cm
4 x E14 40W

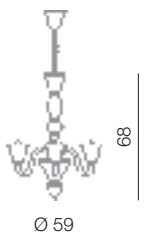

Laguna lampadario 3L
Ø 59 cm - H 68 cm
3 x E14 40W

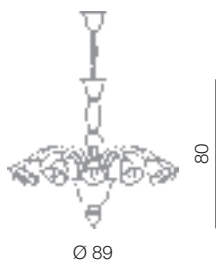

Laguna lampadario 12L BB
Ø 89 cm - H 80 cm
12 x E14 40W

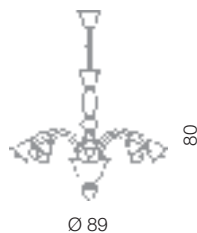

Laguna lampadario 8L BB
Ø 89 cm - H 80 cm
8 x E14 40W



Laguna lampadario 6L BB
Ø 80 cm - H 80 cm
6 x E14 40W

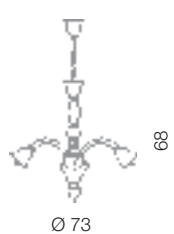

Laguna lampadario 4L BB
Ø 73 cm - H 68 cm
4 x E14 40W

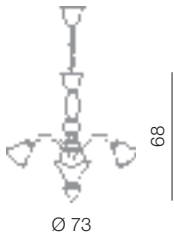

Laguna lampadario 3L BB
Ø 73 cm - H 68 cm
3 x E14 40W

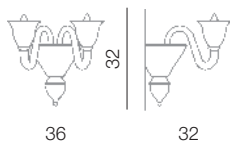

Laguna parete 2L
L 36 cm - H 32 cm - SP 32 cm
2 x E14 40W



Laguna parete 3L
L 58 cm - H 32 cm - SP 38 cm
3 x E14 40W



Laguna plafoniera 12L
Ø 77 cm - H 42 cm
12 x E14 40W



Laguna plafoniera 8L
Ø 77 cm - H 42 cm
8 x E14 40W



Laguna plafoniera 6L
Ø 77 cm - H 42 cm
6 x E14 40W



Laguna plafoniera 4L
Ø 77 cm - H 42 cm
4 x E14 40W



Laguna plafoniera 3L
Ø 77 cm - H 42 cm
3 x E14 40W



Laguna tavolo 1L
Ø 17 cm - H 37 cm
1 x E14 40W

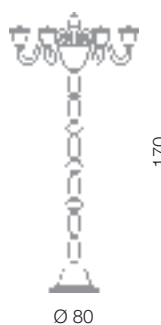

Laguna piantana 6L
Ø 80 cm - H 170 cm
6 x E14 40W



CA' D'ORO



Ca' d'Oro lampadario 12L
Ø 81 cm - H 68 cm
12 x E14 40W

Ca' d'Oro lampadario 6L
Ø 81 cm - H 68 cm
6 x E14 40W



CA' D'ORO



Ca' d'Oro lampadario 8L
Ø 81 cm - H 68 cm
8 x E14 40W

Ca' d'Oro lampadario 8L
Ø 81 cm - H 68 cm
8 x E14 40W



CA' D'ORO



Ca' d'Oro parete 2L
L 44 cm - H 31 cm - SP 38 cm
2 x E14 40W

Ca' d'Oro parete 3L
L 72 cm - H 31 cm - SP 45 cm
3 x E14 40W



CA' D'ORO

Ca' d'Oro tavolo 1L
Ø 21 cm - H 52 cm
1 x E14 40W

CA' D'ORO



Collezione di lampade in stile Veneziano contemporaneo, con vetro soffiato e lavorato a mano, disponibili nei colori cristallo, rosso nero e bianco con montatura nichelata; ambr e cristallo/oro con montatura dorata. Braccetti ad innesto rapido "Sistema Leonardo".

Venetian style chandeliers, in hand-made blown glass, available in clear crystal, red, black and white colours with nickel frame; amber and crystal-gold leaf colours available with 24 KT gold frame. Arms with quick connect "Sistema Leonardo".

Collection des lustres en style Vénitien contemporain, avec verre soufflé et travaillé à la main, disponibles en cristal, rouge, noir et blanc avec finition nickelée, et en ambr e et cristal/or avec finition dorée. Les bras utilisent le "Sistema Leonardo".

Colección de lámparas de estilo Veneciano contemporáneo, con cristal soplado a mano, disponible en color transparente, rojo, negro y blanco con acabado níquel; ambar y cristal/oro con acabado dorado. Brazos con conexión rápida "Sistema Leonardo".



Ca' d'Oro lampadario 12L
Ø 81 cm - H 68 cm
12 x E14 40W

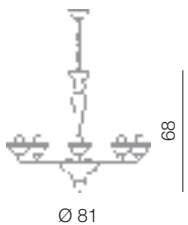

Ca' d'Oro lampadario 8L
Ø 81 cm - H 68 cm
8 x E14 40W

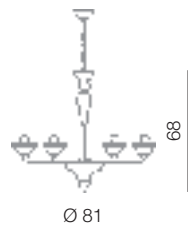

Ca' d'Oro lampadario 6L
Ø 81 cm - H 68 cm
6 x E14 40W

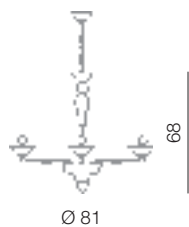

Ca' d'Oro lampadario 4L
Ø 81 cm - H 68 cm
4 x E14 40W

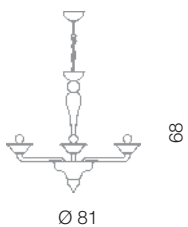

Ca' d'Oro lampadario 3L
Ø 81 cm - H 68 cm
3 x E14 40W

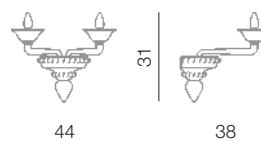

Ca' d'Oro parete 2L
L 44 cm - H 31 cm - SP 38 cm
2 x E14 40W

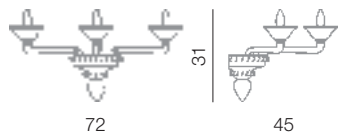

Ca' d'Oro parete 3L
L 72 cm - H 31 cm - SP 45 cm
3 x E14 40W

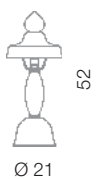

Ca' d'Oro tavolo 1L
Ø 21 cm - H 52 cm
1 x E14 40W



BACH



Bach lampadario 8L
Ø 83 cm - H 66 cm
8 x E14 40W

Bach lampadario 12L
Ø 103 cm - H 66 cm
12 x E14 40W



BACH



Bach lampadario 6L
Ø 83 cm - H 66 cm
6 x E14 40W



BACH



Bach parete 2L
L 45 cm - H 31 cm - SP 36 cm
2 x E14 40W



Bach tavolo 1L
Ø 20 cm - H 48 cm
1 x E14 40W

BACH



Collezione di lampade in stile Classico, in cristallo soffiato e lavorato a mano. Montatura in metallo con finitura nichel.

Lamp collection in Classic style in handmade blown glass. Nickel metal frame.

Luminaire de style Classique, en cristal soufflé et travaillé à la main. Monture en métal, finition nickel.

Colección de lámparas de estilo clásico, de vidrio soplado y elaborado a mano. Armazón de metal con acabado en níquel.

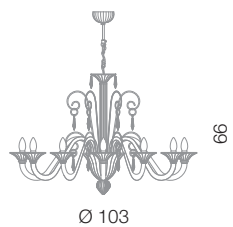

Bach lampadario 12L
Ø 103 cm - H 66 cm
12 x E14 40W

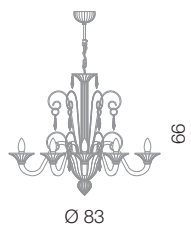

Bach lampadario 8L
Ø 83 cm - H 66 cm
8 x E14 40W



Bach lampadario 6L
Ø 83 cm - H 66 cm
6 x E14 40W

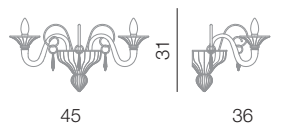

Bach parete 2L
L 45 cm - H 31 cm - SP 36 cm
2 x E14 40W



Bach tavolo 1L
Ø 20 cm - H 48 cm
1 x E14 40W

ALVISE



Alvise lampadario 12L
Ø 106 cm - H 78 cm
12 x E14 40W

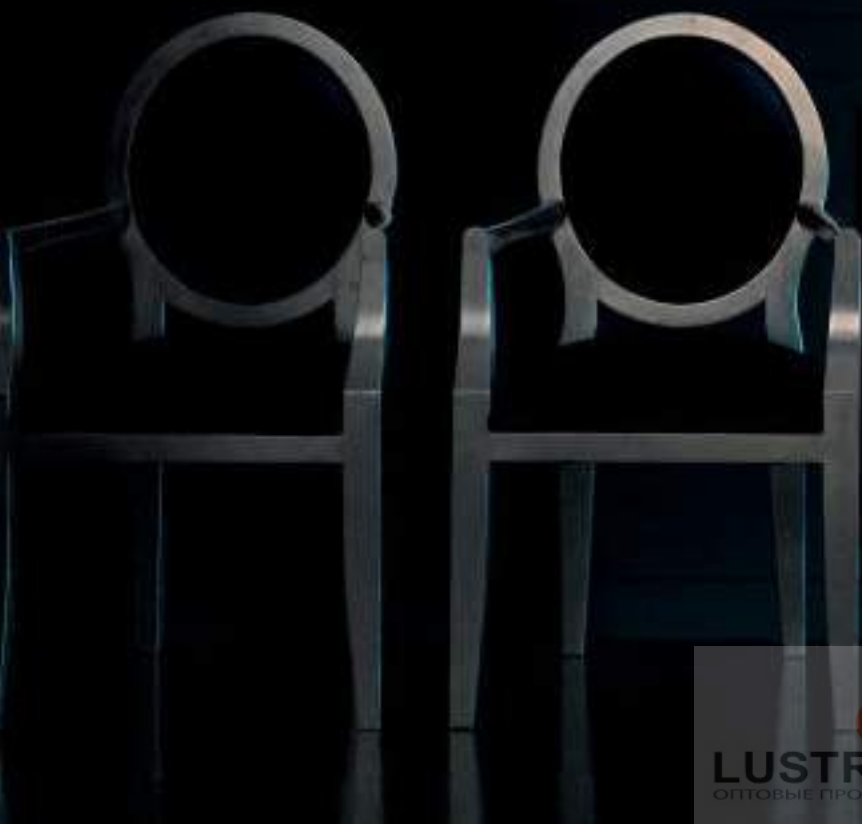

ALVISE



Alvise lampadario 6L
Ø 82 cm - H 78 cm
6 x E14 40W

Alvise lampadario 8L
Ø 82 cm - H 78 cm
8 x E14 40W





Alvise parete 3L
L 65 cm - H 57 cm - SP 39 cm
3 x E14 40W



Alvise tavolo 1L
Ø 20 cm - H 52 cm
1 x E14 40W

ALVISE

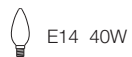

Collezione di lampade in stile classico in vetro soffiato, con pendenti in cristallo molato, disponibili nei colori cristallo, cristallo/oro, rosso, nero, ambra.

Lamp collection in blown glass Classical style with lead crystal 24% PbO trimmings available in crystal, crystal/gold, red, black, amber colours.

Luminaire de style Classique, en verre soufflé et travaillé à la main, de couleur cristal/or, cristal, noir, rouge, ambre avec des détails en cristal meulé.

Colección de lámparas de estilo clásico manufacturadas con vidrio soplado, con colgantes de cristal tallado. Disponibles en color cristal, cristal/oro, rojo, negro y ámbar.

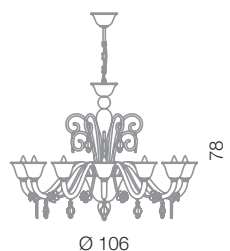

Alvisse lampadario 12L
Ø 106 cm - H 78 cm
12 x E14 40W

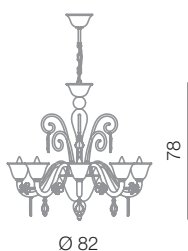

Alvisse lampadario 8L
Ø 82 cm - H 78 cm
8 x E14 40W



Alvisse lampadario 6L
Ø 82 cm - H 78 cm
6 x E14 40W

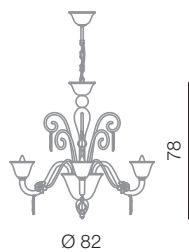

Alvisse lampadario 4L
Ø 82 cm - H 78 cm
4 x E14 40W

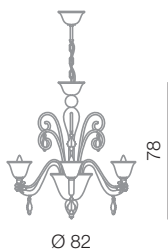

Alvisse lampadario 3L
Ø 82 cm - H 78 cm
3 x E14 40W

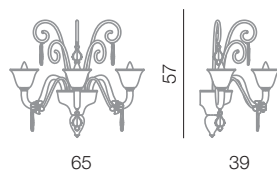

Alvisse parete 3L
L 65 cm - H 57 cm - SP 39 cm
3 x E14 40W

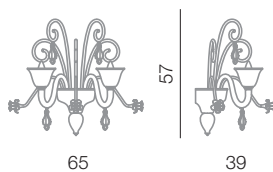

Alvisse parete 2L
L 65 cm - H 57 cm - SP 39 cm
2 x E14 40W



Alvisse tavolo 1L
Ø 20 cm - H 52 cm
1 x E14 40W

BARNABA



Barnaba lampadario 8L
Ø 83 cm - H 82 cm
8 x E14 40W

Barnaba lampadario 12L
Ø 107 cm - H 83 cm
12 x E14 40W



BARNABA



Barnaba lampadario 6L
Ø 80 cm - H 80 cm
6 x E14 40W

Barnaba lampadario 12L
Ø 107 cm - H 83 cm
12 x E14 40W



BARNABA



Barnaba parete 2L
L 48 cm - H 58 cm - SP 33 cm
2 x E14 40W



Barnaba tavolo 1L
Ø 22 cm - H 57 cm
1 x E14 40W

BARNABA



Collezione di lampade in vetro soffiato e lavorato a mano. Disponibili nei colori cristallo, cristallo/oro, rosso, nero, ambra e bianco.

Lamp collection in handmade blown glass. Style available in crystal, crystal/gold, red, black, amber, white colours.

Luminaire de style Classique, en verre soufflé et travaillé à la main, de couleur cristal/or, cristal, noir, rouge, ambre, blanc.

Colección de lámparas manufacturadas con vidrio soplado. Disponibles en color cristal, cristal/oro, rojo, negro, ámbar y blanco.

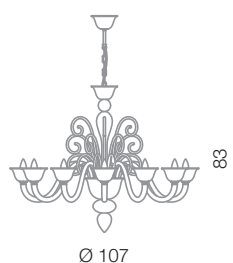

Barnaba lampadario 12L
Ø 107 cm - H 83 cm
12 x E14 40W

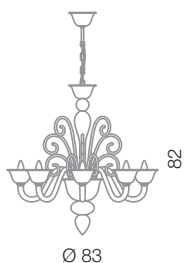

Barnaba lampadario 8L
Ø 83 cm - H 82 cm
8 x E14 40W



Barnaba lampadario 6L
Ø 83 cm - H 83 cm
6 x E14 40W

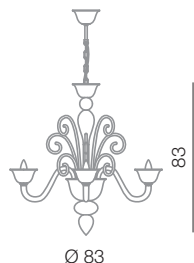

Barnaba lampadario 4L
Ø 83 cm - H 83 cm
4 x E14 40W

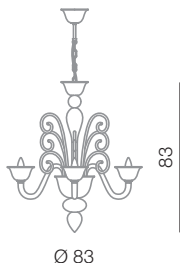

Barnaba lampadario 3L
Ø 83 cm - H 83 cm
3 x E14 40W

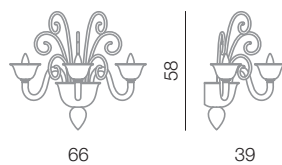

Barnaba parete 3L
L 66 cm - H 58 cm - SP 39 cm
3 x E14 40W

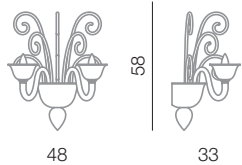

Barnaba parete 2L
L 48 cm - H 58 cm - SP 33 cm
2 x E14 40W



Barnaba tavolo 1L
Ø 22 cm - H 57 cm
1 x E14 40W

SAN MARCO



San Marco lampadario 8L
Ø 100 cm - H 90 cm
8 x E14 40W

San Marco lampadario 6L
Ø 100 cm - H 90 cm
6 x E14 40W



SAN MARCO



San Marco parete 2L
L 56 cm - H 47 cm - SP 47 cm
2 x E14 40W



San Marco tavolo 1L
Ø 20 cm - H 52 cm
1 x E14 40W

SAN MARCO



Collezione di lampade in stile Veneziano contemporaneo, con vetro soffiato e lavorato a mano, disponibili nei colori cristallo, rosso e nero con montatura nichelata; ambra e cristallo/oro con montatura dorata.

Venetian contemporary style chandeliers, in hand-made blown glass, available in clear crystal, red and black colours with nickel frame; amber and crystal-gold leaf colours available with 24 KT gold frame.

Collection des lustres en style Vénitien contemporain, avec verre soufflé et travaillé à la main, disponibles en cristal, rouge, noir avec finition nickelée, et en ambre et cristal/or avec finition dorée.

Colección de lámparas de estilo Veneciano contemporáneo, con cristal soplado a mano, disponible en color transparente, rojo y negro con acabado níquel; ambar y cristal/oro con acabado dorado.

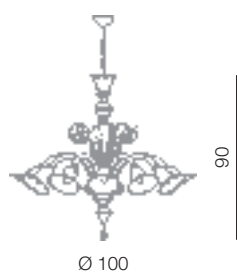

San Marco lampadario 12L
Ø 100 cm - H 90 cm
12 x E14 40W

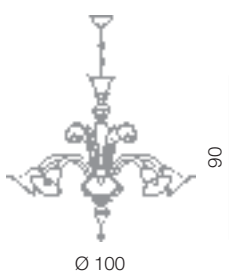

San Marco lampadario 8L
Ø 100 cm - H 90 cm
8 x E14 40W

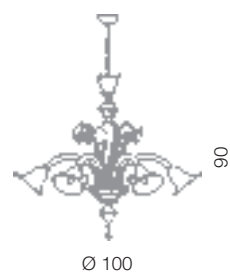

San Marco lampadario 6L
Ø 100 cm - H 90 cm
6 x E14 40W

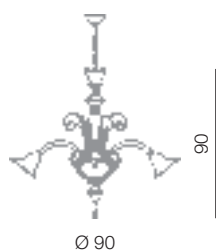

San Marco lampadario 4L
Ø 90 cm - H 90 cm
4 x E14 40W

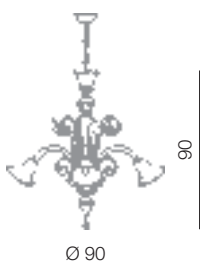

San Marco lampadario 3L
Ø 90 cm - H 90 cm
3 x E14 40W



San Marco parete 3L
L 89 cm - H 47 cm - SP 56 cm
3 x E14 40W

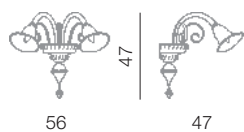

San Marco parete 2L
L 56 cm - H 47 cm - SP 47 cm
2 x E14 40W



San Marco tavolo 1L
Ø 20 cm - H 52 cm
1 x E14 40W



DOGE



Doge lampadario 6L
Ø 82 cm - H 85 cm
6 x E14 40W

Doge lampadario 8L
Ø 82 cm - H 85 cm
8 x E14 40W



DOGE



Doge lampadario 12L
Ø 102 cm - H 85 cm
12 x E14 40W

Doge lampadario 12L
Ø 102 cm - H 85 cm
12 x E14 40W



DOGE



Doge lampadario 12L
Ø 102 cm - H 85 cm
12 x E14 40W

Doge lampadario 6L
Ø 82 cm - H 85 cm
6 x E14 40W



DOGE



Doge parete 2L
L 50 cm - H 41 cm - SP 30 cm
2 x E14 40W



Doge tavolo 1L
Ø 21 cm - H 52 cm
1 x E14 40W

DOGE



Collezione di lampade in stile Classico, in vetro soffiato e lavorato a mano, colore nero, rosso, bianco con inserti in cristallo e in cristallo/oro. Montatura in metallo con finitura nichel o oro.

Lamp collection in Classic style in handmade blown glass, black, red, white colour with crystal inserts and crystal gold leaf. Nickel or gold metal frame.

Luminaire de style Classique, en verre soufflé et travaillé à la main, de couleur noir, rouge, blanc avec des détail en cristal or avec finition dorée. Monture en métal, finition nickel or dorée.

Colección de lámparas de estilo clásico, de vidrio soplado y elaborado a mano, color negro rojo, blanco con inserciones de cristal transparente y cristal/oro con acabado dorado. Armazón de metal con acabado en níquel o dorado.

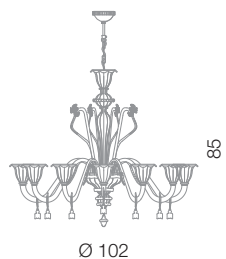

Doge lampadario 12L
Ø 102 cm - H 85 cm
12 x E14 40W

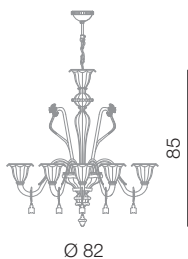

Doge lampadario 8L
Ø 82 cm - H 85 cm
8 x E14 40W



Doge lampadario 6L
Ø 82 cm - H 85 cm
6 x E14 40W



Doge parete 2L
L 50 cm - H 41 cm - SP 30 cm
2 x E14 40W



Doge tavolo 1L
Ø 21 cm - H 52 cm
1 x E14 40W

FLORA



Flora plafoniera Ø 40 cm
Ø 40 cm - H 20 cm
3 x E27 75W

Flora Ø 50 cm
Ø 50 cm - H 20 cm
4 x E27, 75W



FLORA



Flora parete 2L
L 22 cm - H 22 cm - SP 12 cm
2 x E14 40W



Flora tavolo 1L
Ø 30 cm - H 33 cm
1 x E27 60W

FLORA



Collezione di lampade in vetro con fiori lavorati a mano, disponibili in vari colori; montatura nei colori bianco, nichel, dorata 24 KT, ottone.

Set of lamps with hand made glass flowers, available with a wide range of colours; frame available in white, nickel, gold plated 24 KT and brass colours.

Collection des lustres avec fleurs travaillés à la main, disponibles en plusieurs couleurs et avec finition blanche, nickelée, dorée, laitonée.

Colección de lámparas en vidrio con flores hechas a mano, disponible en color blanco, níquel, baño de oro 24 KT y latón.

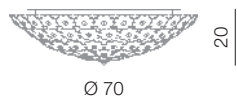

Flora plafoniera Ø 70 cm
Ø 70 cm - H 20 cm
6 x E27 75W

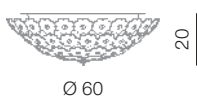

Flora plafoniera Ø 60 cm
Ø 60 cm - H 20 cm
5 x E27 75W

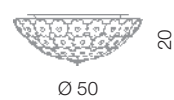

Flora plafoniera Ø 50 cm
Ø 50 cm - H 20 cm
4 x E27 75W



Flora plafoniera Ø 40 cm
Ø 40 cm - H 16 cm
3 x E27 75W



Flora plafoniera Ø 30 cm
Ø 30 cm - H 16 cm
2 x E27 75W

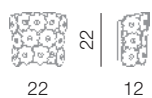

Flora parete 2L
L 22 cm - H 22 cm - SP 12 cm
2 x E14 40W

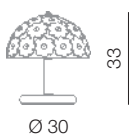

Flora tavolo 1L
Ø 30 cm - H 33 cm
1 x E27 60W

CRISTALLO

lighting collection



Alicante	pag 130
Barcelona	pag 136
Dream	pag 142
Erika	pag 152
Granada	pag 158
Serenade	pag 164
Valencia	pag 170
Temptation	pag 176
Toledo	pag 182
Siviglia	pag 188
Vienna	pag 194
Vienna plus	pag 200

ALICANTE



Alicante lampadario 8L
Ø 77 cm - H 63 cm
8 x E14 40W

Alicante lampadario 12L
Ø 77 cm - H 63 cm
12 x E14 40W



ALICANTE



Alicante lampadario 6L
Ø 58 cm - H 56 cm
6 x E14 40W



ALICANTE



Alicante parete 2L
L 35 cm - H 32 cm - SP 30 cm
2 x E14 40W



Alicante tavolo 1L
Ø 15 cm - H 33 cm
1 x E14 40W

ALICANTE



Collezione di lampade con cristalli al 24% di PbO. Disponibili con montatura dorata 24 KT o nichel. Braccetti ad innesto rapido "Sistema Leonardo".

Lighting collection with lead crystal 24% PbO pendants, available with 24 KT gold or nickel plated frame. Arms with quick connect "Sistema Leonardo".

Collection des lustres en cristal au 24% PbO, disponibles avec finition dorée ou nickelée. Les bras utilisent le "Sistema Leonardo".

Colección de lámparas con cristal al 24% de PbO, disponible en baño de oro 24 KT o níquel. Brazos con conexión rápida "Sistema Leonardo".



Alicante lampadario 12L
Ø 77 cm - H 63 cm
12 x E14 40W

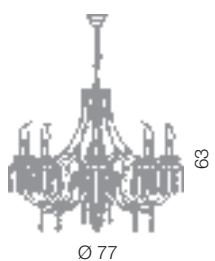

Alicante lampadario 8L
Ø 77 cm - H 63 cm
8 x E14 40W



Alicante lampadario 6L
Ø 58 cm - H 56 cm
6 x E14 40W



Alicante lampadario 4L
Ø 58 cm - H 56 cm
4 x E14 40W

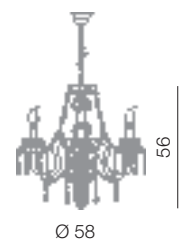

Alicante lampadario 3L
Ø 58 cm - H 56 cm
3 x E14 40W

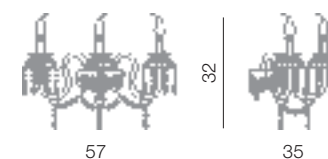

Alicante parete 3L
L 57 cm - H 32 cm - SP 35 cm
3 x E14 40W

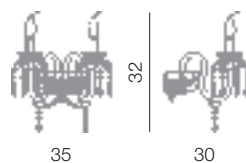

Alicante parete 2L
L 35 cm - H 32 cm - SP 30 cm
2 x E14 40W

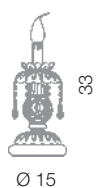

Alicante tavolo 1L
Ø 15 cm - H 33 cm
1 x E14 40W



BARCELONA



Barcelona lampadario 12L
Ø 86 cm - H 57 cm
12 x E14 40W

Barcelona lampadario 8L
Ø 76 cm - H 57 cm
8 x E14 40W



BARCELONA



Barcelona lampadario 6L
Ø 60 cm - H 52 cm
6 x E14 40W

Barcelona lampadario 8L
Ø 76 cm - H 57 cm
8 x E14 40W



BARCELONA



Barcelona parete 2L
L 38 cm - H 38 cm - SP 32 cm
2 x E14 40W



Barcelona tavolo 1L
Ø 15 cm - H 33 cm
1 x E14 40W

BARCELONA



Collezione di lampade con cristalli al 24% di PbO. Disponibili con montatura dorata 24 KT o nichel. Braccetti ad innesto rapido "Sistema Leonardo".

Lighting collection with lead crystal 24% PbO pendants, available with 24 KT gold or nickel plated frame. Arms with quick connect "Sistema Leonardo".

Collection des lustres en cristal au 24% Pbo, disponibles avec finition dorée ou nickelée. Les bras utilisent le "Sistema Leonardo".

Colección de lámparas con cristal al 24% de PbO, disponible en baño de oro 24 KT o níquel. Brazos con conexión rápida "Sistema Leonardo".

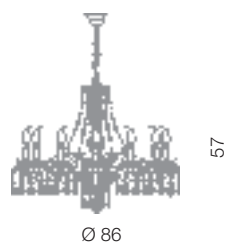

Barcelona lampadario 12L
Ø 86 cm - H 57 cm
12 x E14 40W

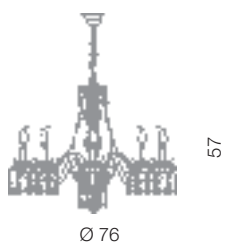

Barcelona lampadario 8L
Ø 76 cm - H 57 cm
8 x E14 40W



Barcelona lampadario 6L
Ø 60 cm - H 52 cm
6 x E14 40W

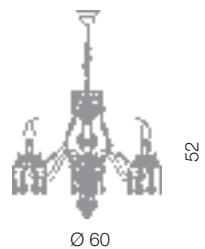

Barcelona lampadario 4L
Ø 60 cm - H 52 cm
4 x E14 40W

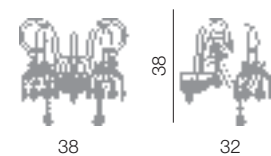

Barcelona parete 2L
L 38 cm - H 38 cm - SP 32 cm
2 x E14 40W



Barcelona tavolo 1L
Ø 15 cm - H 33 cm
1 x E14 40W

DREAM



Dream lampadario 8L
Ø 74 cm - H 85 cm
8 x E14 40W

Dream lampadario 16+8L
Ø 86 cm - H 124 cm
24 x E14 40W



DREAM

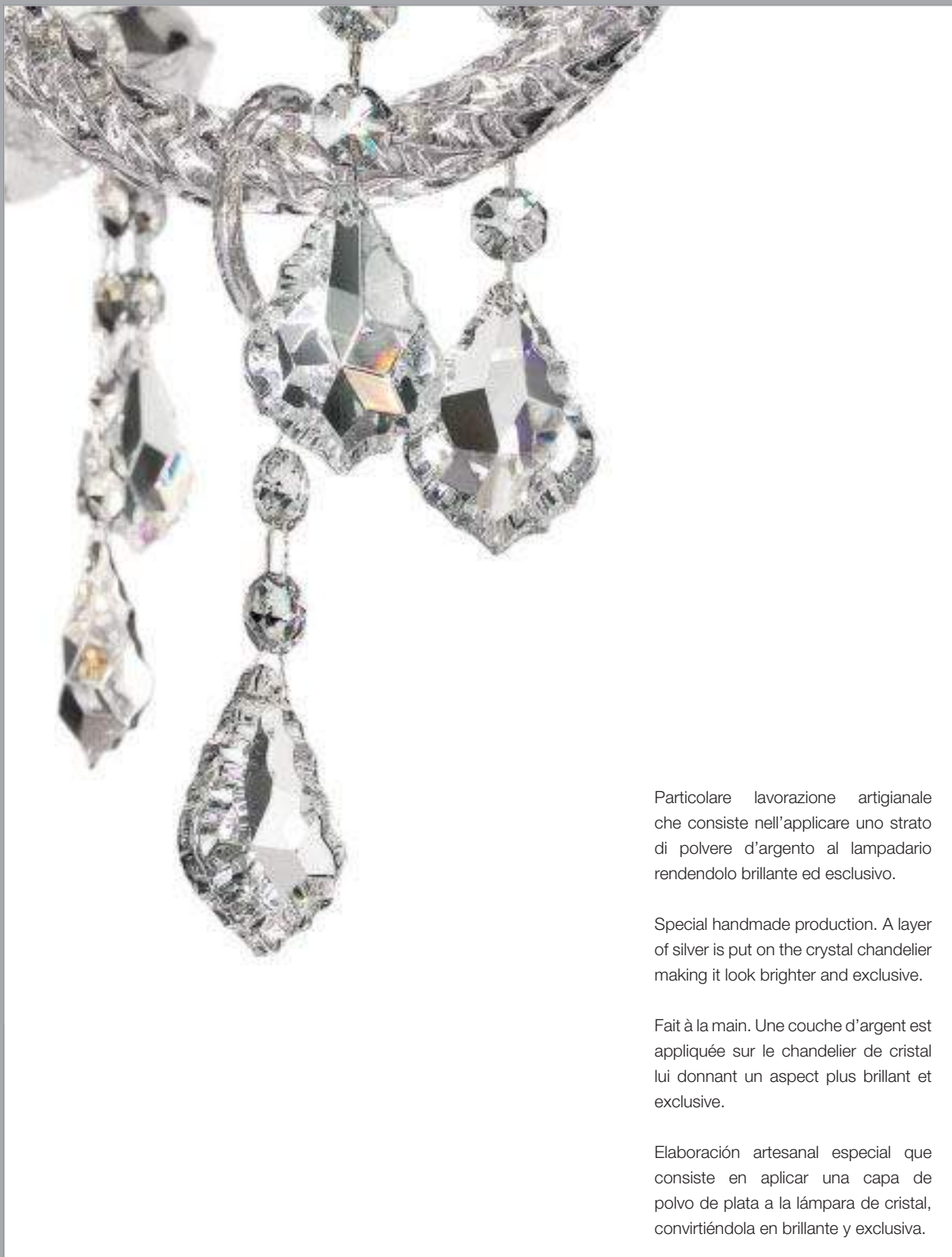

Particolare lavorazione artigianale che consiste nell'applicare uno strato di polvere d'argento al lampadario rendendolo brillante ed esclusivo.

Special handmade production. A layer of silver is put on the crystal chandelier making it look brighter and exclusive.

Fait à la main. Une couche d'argent est appliquée sur le chandelier de cristal lui donnant un aspect plus brillant et exclusive.

Elaboración artesanal especial que consiste en aplicar una capa de polvo de plata a la lámpara de cristal, convirtiéndola en brillante y exclusiva.

Dream lampadario argento 8+4L
Ø 76 cm - H 105 cm
12 x E14 40W



DREAM



Dream lampadario lilla 8+4L
Ø 76 cm - H 105 cm
18 x E14 40W

Dream lampadario nero 8+4L
Ø 76 cm - H 105 cm
12 x E14 40W



DREAM



Dream lampadario 10L
Ø 85 cm - H 98 cm
10 x E14 40W

Dream lampadario 24+12L
Ø 178 cm - H 200 cm
36 x E14 40W



DREAM



Dream parete 2L
L 32 cm - H 40 cm - SP 29 cm
2 x E14 40W



Dream tavolo 1L
Ø 21 cm - H 34 cm
1 x E14 40W

DREAM



Collezione di lampade con cristalli al 24% di PbO. Disponibili con montatura dorata 24 KT o nichel.

Lighting collection with lead crystal 24% PbO pendants, available with 24 KT gold or nickel plated frame.

Collection des lustres en cristal au 24% Pbo, disponibles avec finition dorée ou nickelée.

Colección de lámparas con cristal al 24% de PbO, disponible en baño de oro 24 KT o níquel.

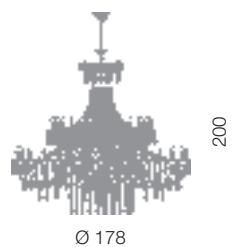

Dream lampadario 24+12L
Ø 178 cm - H 200 cm
36 x E14 40W

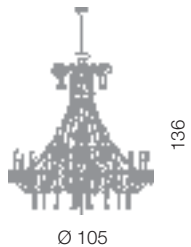

Dream lampadario 18+6L
Ø 105 cm - H 136 cm
24 x E14 40W



Dream lampadario 16+8L
Ø 86 cm - H 124 cm
24 x E14 40W



Dream lampadario 12+6L
Ø 76 cm - H 105 cm
18 x E14 40W



Dream lampadario 8+4L
Ø 76 cm - H 105 cm
12 x E14 40W



Dream lampadario 10L
Ø 85 cm - H 98 cm
10 x E14 40W



Dream lampadario 8L
Ø 74 cm - H 85 cm
8 x E14 40W

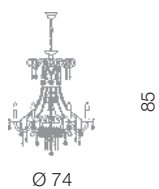

Dream lampadario 6L
Ø 74 cm - H 85 cm
6 x E14 40W

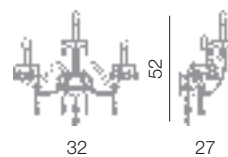

Dream parete 3L
L 32 cm - H 52 cm - SP 27 cm
3 x E14 40W

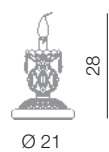

Dream tavolo 1L
Ø 21 cm - H 28 cm
1 x E14 40W



Dream tavolo 1L
Ø 21 cm - H 34 cm
1 x E14 40W

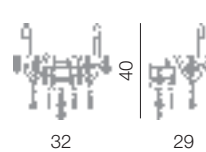

Dream parete 2L
L 32 cm - H 40 cm - SP 29 cm
2 x E14 40W

ERIKA



Erika lampadario 30L
Ø 110 cm - H 133 cm
30 x E14 40W

Erika lampadario 60L
Ø 155 cm - H 217 cm
60 x E14 40W



ERIKA



Erika lampadario 60L
Ø 155 cm - H 217 cm
60 x E14 40W

Erika lampadario 18L
Ø 83 cm - H 108 cm
18 x E14 40W



ERIKA



Erika parete 2L
L 38 cm - H 36 cm - SP 26 cm
2 x E14 40W

ERIKA



Collezione di lampade con cristalli al 24% di PbO. Disponibili con montatura dorata 24 KT o nichel.

Lighting collection with lead crystal 24% PbO pendants, available with 24 KT gold or nickel plated frame.

Collection des lustres en cristal au 24% Pbo, disponibles avec finition dorée ou nickelée.

Colección de lámparas con cristal al 24% de PbO, disponible en baño de oro 24 KT o níquel.

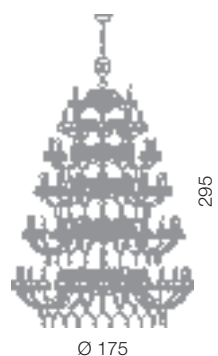

Erika lampadario 80L
Ø 175 cm - H 295 cm
80 x E14 40W



Erika lampadario 60L
Ø 155 cm - H 217 cm
60 x E14 40W



Erika lampadario 40L
Ø 130 cm - H 207 cm
40 x E14 40W

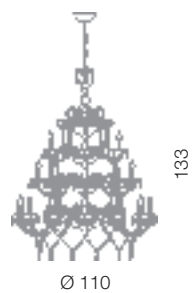

Erika lampadario 30L
Ø 110 cm - H 133 cm
30 x E14 40W

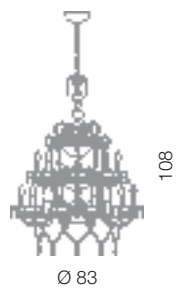

Erika lampadario 18L
Ø 83 cm - H 108 cm
18 x E14 40W



Erika parete 1L
L 38 cm - H 36 cm - SP 32 cm
1 x E14 40W

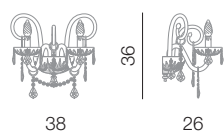

Erika parete 2L
L 38 cm - H 36 cm - SP 26 cm
2 x E14 40W

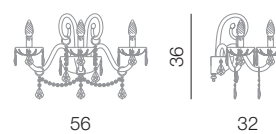

Erika parete 3L
L 56 cm - H 36 cm - SP 32 cm
3 x E14 40W

GRANADA



Granada lampadario 8L
Ø 75 cm - H 64 cm
8 x E14 40W

Granada lampadario 12L
Ø 85 cm - H 64 cm
12 x E14 40W



GRANADA



Granada lampadario 6L
Ø 65 cm - H 58 cm
6 x E14 40W



GRANADA



Granada parete 2L
L 40 cm - H 35 cm - SP 30 cm
2 x E14 40W



Granada tavolo 1L
Ø 15 cm - H 32 cm
1 x E14 40W

GRANADA



Collezione di lampade con cristalli al 24% di PbO. Disponibili con montatura dorata 24 KT o nichel. Braccetti ad innesto rapido "Sistema Leonardo".

Lighting collection with lead crystal 24% PbO pendants, available with 24 KT gold or nickel plated frame. Arms with quick connect "Sistema Leonardo".

Collection des lustres en cristal au 24% Pbo, disponibles avec finition dorée ou nickelée. Les bras utilisent le "Sistema Leonardo".

Colección de lámparas con cristal al 24% de PbO, disponible en baño de oro 24 KT o níquel. Brazos con conexión rápida "Sistema Leonardo".

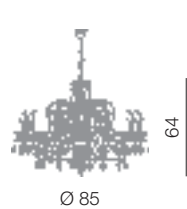

Granada lampadario 12L
Ø 85 cm - H 64 cm
12 x E14 40W

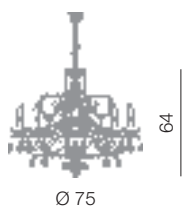

Granada lampadario 8L
Ø 75 cm - H 64 cm
8 x E14 40W

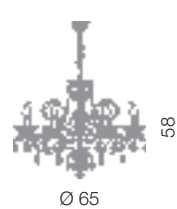

Granada lampadario 6L
Ø 65 cm - H 58 cm
6 x E14 40W

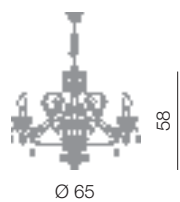

Granada lampadario 4L
Ø 65 cm - H 58 cm
4 x E14 40W

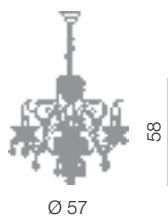

Granada lampadario 3L
Ø 57 cm - H 58 cm
3 x E14 40W

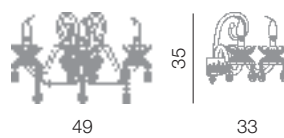

Granada parete 3L
L 49 cm - H 35 cm - SP 33 cm
3 x E14 40W

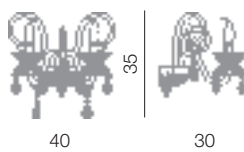

Granada parete 2L
L 40 cm - H 35 cm - SP 30 cm
2 x E14 40W



Granada tavolo 1L
Ø 15 cm - H 32 cm
1 x E14 40W

SERENADE



Serenade lampadario 8+4L
Ø 72 cm - H 70 cm
12 x E14 40W

Serenade lampadario 8L
Ø 72 cm - H 61 cm
8 x E14 40W



SERENADE



Serenade lampadario 6L
Ø 62 cm - H 61 cm
6 x E14 40W



SERENADE



Serenade parete 2L
L 35 cm - H 35 cm - SP 27 cm
2 x E14 40W



Serenade tavolo 1L
Ø 15 cm - H 32 cm
1 x E14 40W

SERENADE



Collezione di lampade con cristalli al 24% di PbO. Disponibili con montatura dorata 24 KT o nichel. Braccetti ad innesto rapido "Sistema Leonardo".

Lighting collection with lead crystal 24% PbO pendants, available with 24 KT gold or nickel plated frame. Arms with quick connect "Sistema Leonardo".

Collection des lustres en cristal au 24% Pbo, disponibles avec finition dorée ou nickelée. Les bras utilisent le "Sistema Leonardo".

Colección de lámparas con cristal al 24% de PbO, disponible en baño de oro 24 KT o níquel. Brazos con conexión rápida "Sistema Leonardo".

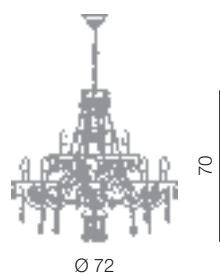

Serenade lampadario 8+4L
Ø 72 cm - H 70 cm
12 x E14 40W

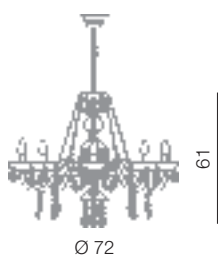

Serenade lampadario 8L
Ø 72 cm - H 61 cm
8 x E14 40W



Serenade lampadario 6L
Ø 62 cm - H 61 cm
6 x E14 40W

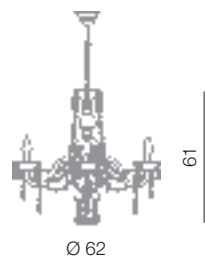

Serenade lampadario 4L
Ø 62 cm - H 61 cm
4 x E14 40W

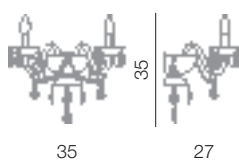

Serenade parete 2L
L 35 cm - H 35 cm - SP 27 cm
2 x E14 40W



Serenade tavolo 1L
Ø 15 cm - H 32 cm
1 x E14 40W

VALENCIA



Valencia lampadario 12L
Ø 76 cm - H 60 cm
12 x E14 40W

Valencia lampadario 6L
Ø 66 cm - H 60 cm
6 x E14 40W



VALENCIA



Valencia lampadario 8L
Ø 66 cm - H 60 cm
8 x E14 40W



VALENCIA



Valencia parete 2L
L 35 cm - H 26 cm - SP 31 cm
2 x E14 40W



Valencia tavolo 1L
Ø 15 cm - H 35 cm
1 x E14 40W

VALENCIA



Collezione di lampade con cristalli al 24% di PbO. Disponibili con montatura dorata 24 KT o nichel. Braccetti ad innesto rapido "Sistema Leonardo".

Lighting collection with lead crystal 24% PbO pendants, available with 24 KT gold or nickel plated frame. Arms with quick connect "Sistema Leonardo".

Collection des lustres en cristal au 24% Pbo, disponibles avec finition dorée ou nickelée. Les bras utilisent le "Sistema Leonardo".

Colección de lámparas con cristal al 24% de PbO, disponible en baño de oro 24 KT o níquel. Brazos con conexión rápida "Sistema Leonardo".

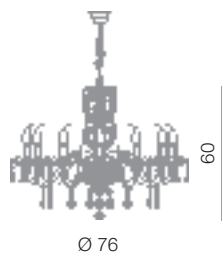

Valencia lampadario 12L
Ø 76 cm - H 60 cm
12 x E14 40W

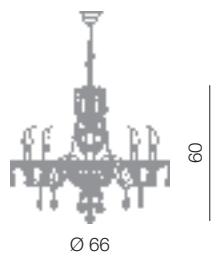

Valencia lampadario 8L
Ø 66 cm - H 60 cm
8 x E14 40W

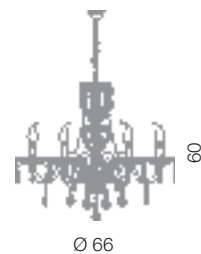

Valencia lampadario 6L
Ø 66 cm - H 60 cm
6 x E14 40W



Valencia parete 3L
L 58 cm - H 26 cm - SP 36 cm
3 x E14 40W

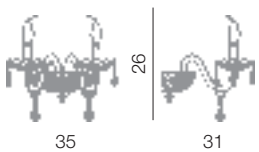

Valencia parete 2L
L 35 cm - H 26 cm - SP 31 cm
2 x E14 40W



Valencia tavolo 1L
Ø 15 cm - H 35 cm
1 x E14 40W

TEMPTATION



Temptation lampadario 8+4L
Ø 76 cm - H 71 cm
12 x E14 40W

Temptation lampadario 8L
Ø 76 cm - H 62 cm
8 x E14 40W



TEMPTATION



Temptation lampadario 6L
Ø 65 cm - H 62 cm
6 x E14 40W



TEMPTATION



Temptation parete 2L
L 36 cm - H 35 cm - SP 26 cm
2 x E14 40W



Temptation tavolo 1L
Ø 21 cm - H 34 cm
1 x E14 40W

TEMPTATION



Collezione di lampade con cristalli al 24% di PbO. Disponibili con montatura dorata 24 KT o nichel. Braccetti ad innesto rapido "Sistema Leonardo".

Lighting collection with lead crystal 24% PbO pendants, available with 24 KT gold or nickel plated frame. Arms with quick connect "Sistema Leonardo".

Collection des lustres en cristal au 24% Pbo, disponibles avec finition dorée ou nickelée. Les bras utilisent le "Sistema Leonardo".

Colección de lámparas con cristal al 24% de PbO, disponible en baño de oro 24 KT o níquel. Brazos con conexión rápida "Sistema Leonardo".

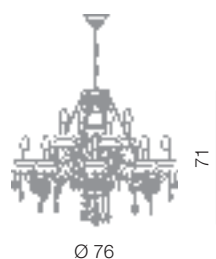

Temptation lampadario 8+4L
Ø 76 cm - H 71 cm
12 x E14 40W



Temptation lampadario 8L
Ø 76 cm - H 62 cm
8 x E14 40W



Temptation lampadario 6L
Ø 65 cm - H 62 cm
6 x E14 40W



Temptation lampadario 4L
Ø 65 cm - H 62 cm
4 x E14 40W

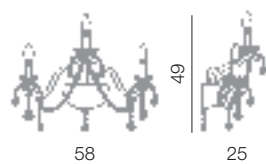

Temptation parete 3L
L 58 cm - H 49 cm - SP 25 cm
3 x E14 40W

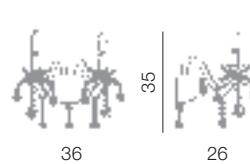

Temptation parete 2L
L 36 cm - H 35 cm - SP 26 cm
2 x E14 40W

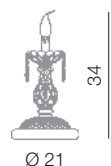

Temptation tavolo 1L
Ø 21 cm - H 34 cm
1 x E14 40W



Temptation tavolo 1L
Ø 21 cm - H 28 cm
1 x E14 40W

TOLEDO



Toledo lampadario 8+4L
Ø 75 cm - H 58 cm
12 x E14 40W

Toledo lampadario 8L
Ø 75 cm - H 58 cm
8 x E14 40W



TOLEDO



Toledo lampadario 6L
Ø 65 cm - H 58 cm
6 x E14 40W

Toledo lampadario 6L
Ø 65 cm - H 58 cm
6 x E14 40W



TOLEDO



Toledo parete 2L
L 35 cm - H 26 cm - SP 32 cm
2 x E14 40W



Toledo tavolo 1L
Ø 15 cm - H 32 cm
1 x E14 40W

TOLEDO



Collezione di lampade con cristalli al 24% di PbO. Disponibili con montatura in ottone o nichel. Braccetti ad innesto rapido "Sistema Leonardo".

Lighting collection with lead crystal 24% PbO pendants, available with brass or nickel frame. Arms with quick connect "Sistema Leonardo".

Collection des lustres en cristal au 24% Pbo, disponibles avec finition laiton ou nickelée. Les bras utilisent le "Sistema Leonardo".

Colección de lámparas con cristal al 24% de PbO, disponible en latón o níquel. Brazos con conexión rápida "Sistema Leonardo".

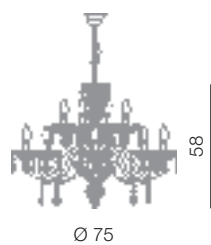

Toledo lampadario 8+4L
Ø 75 cm - H 58 cm
12 x E14 40W

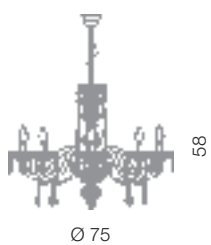

Toledo lampadario 8L
Ø 75 cm - H 58 cm
8 x E14 40W



Toledo lampadario 6L
Ø 65 cm - H 58 cm
6 x E14 40W

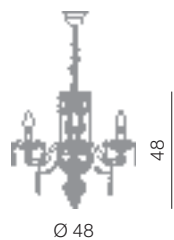

Toledo lampadario 4L
Ø 48 cm - H 48 cm
4 x E14 40W

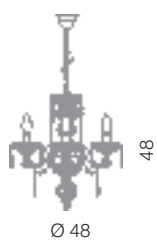

Toledo lampadario 3L
Ø 48 cm - H 48 cm
3 x E14 40W

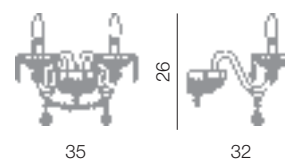

Toledo parete 2L
L 35 cm - H 26 cm - SP 32 cm
2 x E14 40W



Toledo tavolo 1L
Ø 15 cm - H 32 cm
1 x E14 40W

SIVIGLIA



Siviglia lampadario 6L
Ø 64 cm - H 57 cm
6 x E14 40W

Siviglia lampadario 8+4L
Ø 75 cm - H 57 cm
12 x E14 40W



SIVIGLIA



Siviglia lampadario 8L
Ø 75 cm - H 57 cm
8 x E14 40W



SIVIGLIA



Siviglia parete 2L
L 35 cm - H 25 cm - SP 32 cm
2 x E14 40W



Siviglia tavolo 1L
Ø 15 cm - H 36 cm
1 x E14 40W

SIVIGLIA



Collezione di lampade con cristalli al 24% di PbO. Disponibili con montatura in ottone o nichel. Braccetti ad innesto rapido "Sistema Leonardo".

Lighting collection with lead crystal 24% PbO pendants, available with brass or nickel plated frame. Arms with quick connect "Sistema Leonardo".

Collection des lustres en cristal au 24% PbO, disponibles avec finition laiton ou nickelée. Les bras utilisent le "Sistema Leonardo".

Colección de lámparas con cristal al 24% de PbO, disponible en baño de latón o níquel. Brazos con conexión rápida "Sistema Leonardo".

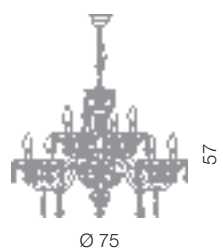

Siviglia lampadario 8+4L
Ø 75 cm - H 57 cm
12 x E14 40W

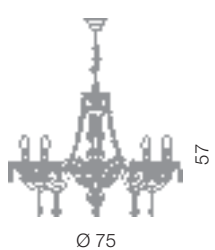

Siviglia lampadario 8L
Ø 75 cm - H 57 cm
8 x E14 40W



Siviglia lampadario 6L
Ø 64 cm - H 57 cm
6 x E14 40W



Siviglia lampadario 4L
Ø 64 cm - H 57 cm
4 x E14 40W



Siviglia lampadario 3L
Ø 58 cm - H 55 cm
3 x E14 40W

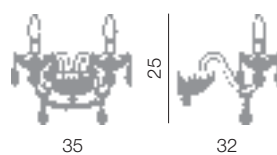

Siviglia parete 2L
L 35 cm - H 25 cm - SP 32 cm
2 x E14 40W



Siviglia tavolo 1L
Ø 15 cm - H 36 cm
1 x E14 40W

VIENNA



Vienna lampadario 5L
Ø 46 cm - H 42 cm
5 x E14 40W

Vienna parete 1L
L 12 cm - H 23 cm - SP 23 cm
1 x E14 40W

Vienna parete 2L
L 32 cm - H 23 cm - SP 19 cm
2 x E14 40W

Vienna lampadario 5L
Ø 46 cm - H 42 cm
5 x E14 40W



Vienna lampadario 8L
Ø 46 cm - H 42 cm
8 x E14 40W

VIENNA



Vienna lampadario 9L (6+3)
Ø 46 cm - H 42 cm
9 x E14 40W

Vienna lampadario 12L (8+4)
Ø 46 cm - H 42 cm
12 x E14 40W



VIENNA



Vienna tavolo 3L
Ø 31 cm - H 42 cm
3 x E14 40W



Vienna tavolo 2L
L 21 cm - H 29 cm
2 x E14 40W



Vienna tavolo 1L
L 19 cm - H 21 cm
1 x E14 40W

VIENNA



Collezione di lampade in stile Classico, in vetro soffiato e cristallo acrilico disponibile nei colori cristallo, blu, rosso, nero, bianco. Montatura in metallo con finitura cromata o ottonata.

Lamp collection in Classic style in blown glass and acrylic crystal, available in crystal, blue, red, black, white colours. Chrome or brass metal frame.

Luminaire de style Classique, en verre soufflé et cristal acrylique, disponibles dans les couleurs: cristal, bleu, rouge, noir et blanc. Monture en métal, finition chromée ou laitonée.

Colección de lámparas de estilo clásico, de vidrio soplado y cristal acrílico disponibles en los siguientes colores: cristal, azul, rojo, negro y blanco. Armazón de metal con acabado cromado o latonado.



Vienna lampadario 3L
Ø 46 cm - H 42 cm
3 x E14 40W



Vienna lampadario 5L
Ø 46 cm - H 42 cm
5 x E14 40W



Vienna lampadario 8L
Ø 46 cm - H 42 cm
8 x E14 40W



Vienna lampadario 9L (6+3)
Ø 46 cm - H 42 cm
9 x E14 40W



Vienna lampadario 12L (8+4)
Ø 46 cm - H 42 cm
12 x E14 40W

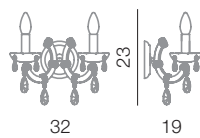

Vienna parete 2L
L 32 cm - H 23 cm - SP 19 cm
2 x E14 40W

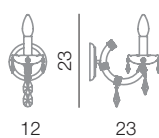

Vienna parete 1L
L 12 cm - H 23 cm - SP 23 cm
1 x E14 40W



Vienna tavolo 3L
Ø 31 cm - H 42 cm
3 x E14 40W



Vienna tavolo 2L
L 21 cm - H 29 cm
2 x E14 40W



Vienna tavolo 1L
L 19 cm - H 21 cm
1 x E14 40W

VIENNA PLUS



Vienna Plus lampadario 10+10+5L
Ø 92 cm - H 94 cm
25 x E14 40W

Vienna Plus lampadario 14+14+7L
Ø 105 cm - H 94 cm
35 x E14 40W



VIENNA PLUS



Vienna Plus lampadario 10L
Ø 75 cm - H 52 cm
10 x E14 40W

Vienna Plus lampadario 12+6L

Ø 75 cm - H 52 cm

18 x E14 40W



VIENNA PLUS



Vienna Plus parete 2L
L 39 cm - H 27 cm - SP 24 cm
2 x E14 40W



Vienna Plus tavolo 6L
Ø 48 cm - H 53 cm
6 x E14 40W

VIENNA PLUS



Collezione di lampade in stile classico in vetro soffiato e cristallo acrilico. Disponibile nei colori cristallo, blu, rosso, nero, bianco e ambr. Montatura in metallo con finitura cromata o ottonata.

Lamp collection in Classical style in blown glass and acrylic crystal available in crystal, blue, red, black, white and amber colours. Chrome or brass metal frame.

Collection de lampes de style classique en verre soufflé et cristal acrylique. Disponible dans les coloris cristal, bleu, rouge, noire, blanc et ambr. Monture en métal avec finition chrome ou laiton.

Colección de lámparas de estilo clásico fabricadas con vidrio soplado y cristal acrílico. Disponibles en color cristal, azul, rojo, negro, blanco y ambar. Estructura de metal con acabado cromado o dorado.

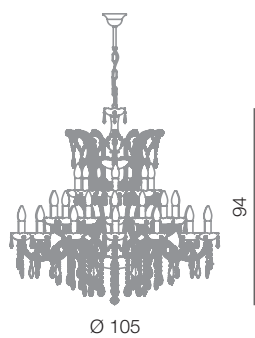

Vienna Plus lampadario 14+14+7L
Ø 105 cm - H 94 cm
35 x E14 40W



Vienna Plus lampadario 10+10+5L
Ø 92 cm - H 94 cm
25 x E14 40W



Vienna Plus lampadario 12+6L
Ø 75 cm - H 52 cm
18 x E14 40W

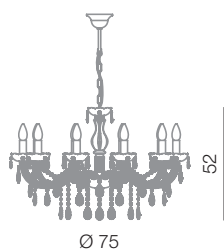

Vienna Plus lampadario 10L
Ø 75 cm - H 52 cm
10 x E14 40W

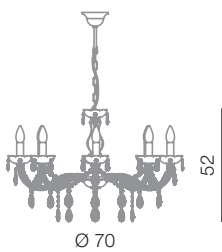

Vienna Plus lampadario 8L
Ø 70 cm - H 52 cm
8 x E14 40W

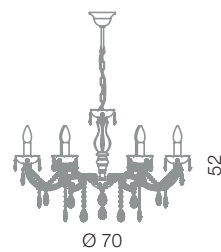

Vienna Plus lampadario 6L
Ø 70 cm - H 52 cm
6 x E14 40W



Vienna Plus parete 2L
L 39 cm - H 27 cm - SP 24 cm
2 x E14 40W



Vienna Plus tavolo 6L
Ø 48 cm - H 53 cm
6 x E14 40W

CLASSICO

lighting collection



Amsterdam	pag 208
Beethoven	pag 214
Galaxy	pag 220
Mosca	pag 224
New Orleans	pag 228
Osaka	pag 234
Pegaso	pag 240
Roma	pag 246
Settat	pag 252
Twister	pag 260
Salisburgo	pag 268
Graz	pag 274
Innsbruck	pag 278
Lienz	pag 282
Paralumi	pag 288

AMSTERDAM



Amsterdam sospensione Ø 30 cm
Ø 30 cm - H 42 cm
3 x E14 40W

Amsterdam lampadario Impero Ø 60 cm
Ø 63 cm - H 87 cm
9 x E14 40W



AMSTERDAM





Amsterdam parete 2L
L 16 cm - H 18 cm - SP 11 cm
2 x E14 40W

Amsterdam plafoniera Ø 50 cm
Ø 52 cm - H 32 cm
6 x E14 40W



AMSTERDAM

  E14 40W



Collezione di lampade stile Classico con cristalli al 24% di PbO e disponibili con montatura dorata 24 KT o nichel.

Lighting collection Classico style with lead crystal 24% PbO pendants, available with 24 KT gold or nickel plated frame.

Collection des lustres style Classique avec cristaux au 24% de PbO et disponibles avec finition dorée ou nickelée.

Colección de lámparas estilo clásico con cristal al 24% de PbO, disponible en baño de oro 24 KT o níquel.



Amsterdam tavolo 1L
Ø 15 cm - H 23 cm
1 x E27 40W

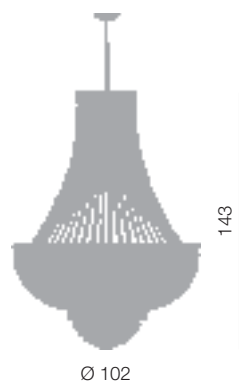

Amsterdam lampadario Impero Ø 100 cm
Ø 102 cm - H 143 cm
18 x E14 40W

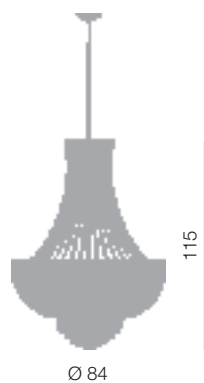

Amsterdam lampadario Impero Ø 80 cm
Ø 84 cm - H 115 cm
15 x E14 40W



Amsterdam lampadario Impero Ø 60 cm
Ø 63 cm - H 87 cm
9 x E14 40W

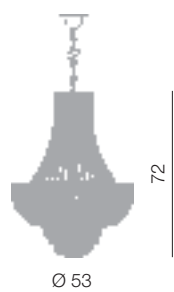

Amsterdam lampadario Impero Ø 50 cm
Ø 53 cm - H 72 cm
7 x E14 40W

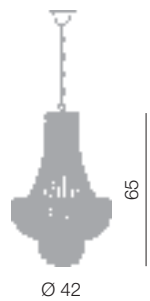

Amsterdam lampadario Impero Ø 40 cm
Ø 42 cm - H 65 cm
6 x E14 40W



Amsterdam lampadario Impero Ø 30 cm
Ø 32 cm - H 52 cm
5 x E14 40W

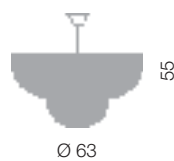

Amsterdam sospensione Ø 60 cm
Ø 63 cm - H 55 cm
8 x E14 40W

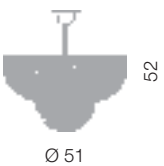

Amsterdam sospensione Ø 50 cm
Ø 51 cm - H 52 cm
6 x E14 40W



Amsterdam sospensione Ø 40 cm
Ø 40 cm - H 47 cm
4 x E14 40W

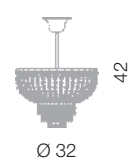

Amsterdam sospensione Ø 30 cm
Ø 32 cm - H 42 cm
3 x E14 40W

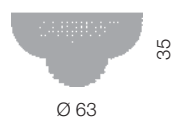

Amsterdam plafoniera Ø 60 cm
Ø 63 cm - H 35 cm
8 x E14 40W

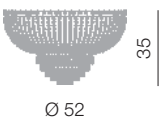

Amsterdam plafoniera Ø 50 cm
Ø 52 cm - H 32 cm
6 x E14 40W

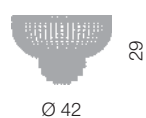

Amsterdam plafoniera Ø 40 cm
Ø 42 cm - H 29 cm
4 x E14 40W

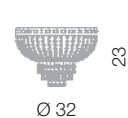

Amsterdam plafoniera Ø 30 cm
Ø 32 cm - H 23 cm
3 x E14 40W

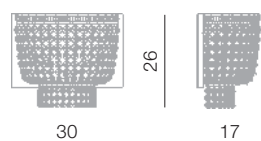

Amsterdam parete 3L
L 30 cm - H 26 cm - SP 17 cm
3 x E14 40W

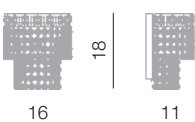

Amsterdam parete 2L
L 16 cm - H 18 cm - SP 11 cm
2 x E14 40W

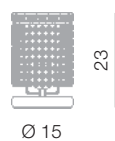

Amsterdam tavolo 1L
Ø 15 cm - H 23 cm
1 x E27 40W



BEETHOVEN



Beethoven sospensione Ø 60 cm
Ø 61 cm - H 61 cm
8 x E14 40W

Beethoven lampadario Impero Ø 80 cm
Ø 81 cm - H 110 cm
16 x E14 40W



BEETHOVEN





Beethoven parete 2L
L 16 cm - H 18 cm - SP 12 cm
2 x E14 40W

Beethoven plafoniera Ø 60 cm
Ø 61 cm - H 43 cm
8 x E14 40W



BEETHOVEN

  E14 40W



Collezione di lampade stile Classico con cristalli al 24% di PbO e disponibili con montatura dorata 24 KT o nichel.

Lighting collection Classico style with lead crystal 24% PbO pendants, available with 24 KT gold or nickel plated frame.

Collection des lustres style Classique avec cristaux au 24% de PbO et disponibles avec finition dorée ou nickelée.

Colección de lámparas estilo clásico con cristal al 24% de PbO, disponible en baño de oro 24 KT o níquel.



Beethoven tavolo 1L
Ø 16 cm - H 23 cm
1 x E27 40W

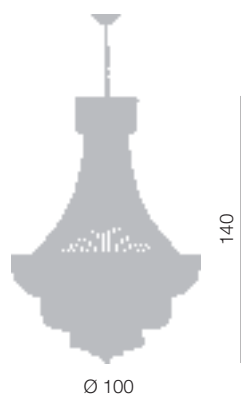

140

Ø 100

Beethoven lampadario Impero Ø 100 cm
Ø 100 cm - H 140 cm
18 x E14 40W



110

Ø 81

Beethoven lampadario Impero Ø 80 cm
Ø 81 cm - H 110 cm
16 x E14 40W

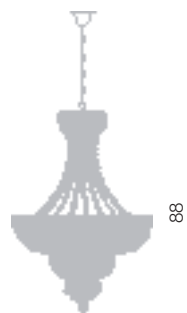

88

Ø 61

Beethoven lampadario Impero Ø 60 cm
Ø 61 cm - H 88 cm
9 x E14 40W

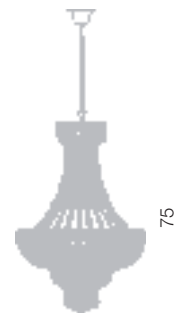

75

Ø 50

Beethoven lampadario Impero Ø 50 cm
Ø 50 cm - H 75 cm
7 x E14 40W

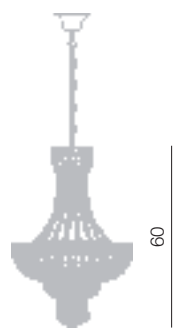

60

Ø 40

Beethoven lampadario Impero Ø 40 cm
Ø 40 cm - H 60 cm
6 x E14 40W



61

Ø 61

Beethoven sospensione Ø 60 cm
Ø 61 cm - H 61 cm
8 x E14 40W



51

Ø 51

Beethoven sospensione Ø 50 cm
Ø 51 cm - H 51 cm
6 x E14 40W



46

Ø 41

Beethoven sospensione Ø 40 cm
Ø 41 cm - H 46 cm
4 x E14 40W



43

Ø 61

Beethoven plafoniera Ø 60 cm
Ø 61 cm - H 43 cm
8 x E14 40W



33

Ø 51

Beethoven plafoniera Ø 50 cm
Ø 51 cm - H 33 cm
6 x E14 40W



28

Ø 41

Beethoven plafoniera Ø 40 cm
Ø 41 cm - H 28 cm
4 x E14 40W



41

Ø 27

Beethoven tavolo 2L
Ø 27 cm - H 41 cm
2 x E14 40W

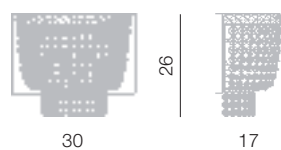

26

30

17

Beethoven parete 3L
L30 cm - H 26 cm - SP 17 cm
3 x E14 40W

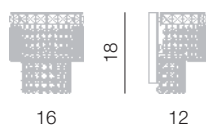

18

16

12

Beethoven parete 2L
L 16 cm - H 18 cm - SP 12 cm
2 x E14 40W



23

Ø 16

Beethoven tavolo 1L
Ø 16 cm - H 23 cm
1 x E27 40W



GALAXY



Galaxy lampadario 4L
Ø 45 cm - H 81 cm
4 x G9 40W

Galaxy lampadario 6L
Ø 60 cm - H 85 cm
6 x G9 40W



GALAXY



oro lucido



oro satinato

Galaxy lampadario 4L
Ø 45 cm - H 81 cm
4 x G9 40W

GALAXY

Modello depositato / Registered design / modèle déposé / artículo patentado



Collezione di lampade stile Classico con cristalli al 24% di PbO e disponibili con montatura dorata 24 KT o nichel.

Lighting collection Classico style with lead crystal 24% PbO pendants, available with 24 KT gold or nickel plated frame.

Collection des lustres style Classique avec cristaux au 24% de PbO et disponibles avec finition dorée ou nickelée.

Colección de lámparas estilo clásico con cristal al 24% de PbO, disponible en baño de oro 24 KT o níquel.

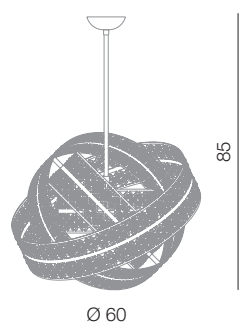

Galaxy lampadario 6L
Ø 60 cm - H 85 cm
6 x G9 40W



Galaxy lampadario 4L
Ø 45 cm - H 81 cm
4 x G9 40W

MOSCA



Mosca plafoniera Ø 40 cm
Ø 40 cm - H 25 cm
3 x E14 40W

Mosca sospensione Ø 50 cm
Ø 50 cm - H 44 cm
4 x E14 40W





Mosca parete 2L
L 15 cm - H 16 cm - SP 9 cm
2 x E14 40W



Mosca tavolo 1L
Ø 15 cm - H 24 cm
1 x E27 40W

MOSCA



Collezione di lampade stile Classico con cristalli al 24% di PbO e disponibili con montatura dorata 24 KT o nichel.

Lighting collection Classico style with lead crystal 24% PbO pendants, available with 24 KT gold or nickel plated frame.

Collection des lustres style Classique avec cristaux au 24% de PbO et disponibles avec finition dorée ou nickelée.

Colección de lámparas estilo clásico con cristal al 24% de PbO, disponible en baño de oro 24 KT o níquel.

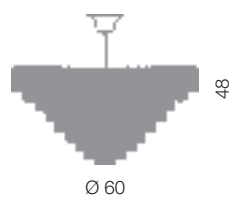

Mosca sospensione Ø 60 cm
Ø 60 cm - H 48 cm
6 x E14 40W

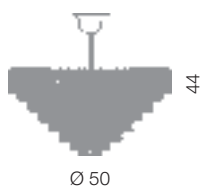

Mosca sospensione Ø 50 cm
Ø 50 cm - H 44 cm
4 x E14 40W

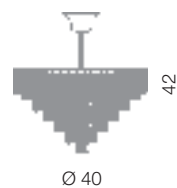

Mosca sospensione Ø 40 cm
Ø 40 cm - H 42 cm
3 x E14 40W

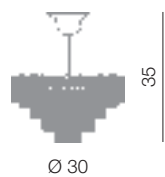

Mosca sospensione Ø 30 cm
Ø 30 cm - H 35 cm
3 x E14 40W

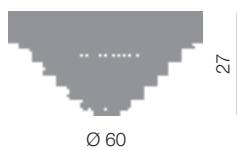

Mosca plafoniera Ø 60 cm
Ø 60 cm - H 27 cm
6 x E14 40W

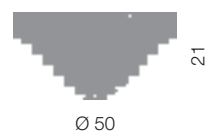

Mosca plafoniera Ø 50 cm
Ø 50 cm - H 21 cm
6 x E14 40W

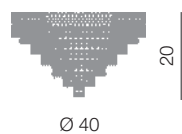

Mosca plafoniera Ø 40 cm
Ø 40 cm - H 20 cm
4 x E14 40W



Mosca plafoniera Ø 30 cm
Ø 30 cm - H 18 cm
3 x E14 40W

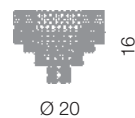

Mosca plafoniera Ø 20 cm
Ø 20 cm - H 16 cm
2 x E14 40W

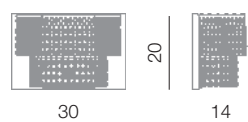

Mosca parete 3L
L 30 cm - H 20 cm - SP 14 cm
3 x E14 40W

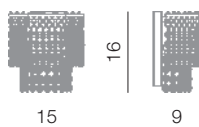

Mosca parete 2L
L 15 cm - H 16 cm - SP 9 cm
2 x E14 40W

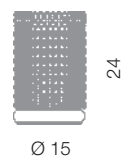

Mosca tavolo 1L
Ø 15 cm - H 24 cm
1 x E27 40W



NEW ORLEANS



New Orleans lampadario Impero Ø 40 cm
Ø 40 cm - H 57 cm
6 x E14 40W

New Orleans lampadario Impero Ø 60 cm
Ø 60 cm - H 77 cm
9 x E14 40W



NEW ORLEANS





New Orleans sospensione Ø 40 cm
Ø 42 cm - H 43 cm
4 x E14 40W

New Orleans plafoniera Ø 60 cm
Ø 60 cm - H 31 cm
8 x E14 40W



NEW ORLEANS

  E14 40W



Collezione di lampade stile Classico con cristalli al 24% di PbO e disponibili con montatura dorata 24 KT o nichel.

Lighting collection Classico style with lead crystal 24% PbO pendants, available with 24 KT gold or nickel plated frame.

Collection des lustres style Classique avec cristaux au 24% de PbO et disponibles avec finition dorée ou nickelée.

Colección de lámparas estilo clásico con cristal al 24 % de PbO, disponible en baño de oro 24 KT o níquel.



New Orleans parete 2L
L 21 cm - H 20 cm - SP 12 cm
2 x E14 40W

New Orleans tavolo 1L
Ø 19 cm - H 25 cm
1 x E27 40W

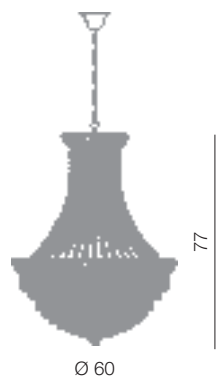

New Orleans lampadario Impero Ø 60 cm
Ø 60 cm - H 77 cm
9 x E14 40W

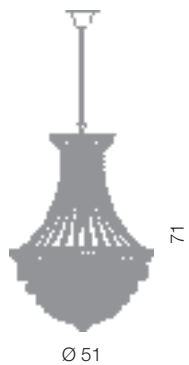

New Orleans lampadario Impero Ø 51 cm
Ø 51 cm - H 71 cm
7 x E14 40W



New Orleans lampadario Impero Ø 40 cm
Ø 40 cm - H 57 cm
6 x E14 40W



New Orleans lampadario Impero Ø 30 cm
Ø 30 cm - H 44 cm
5 x E14 40W

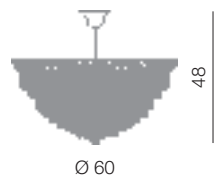

New Orleans sospensione Ø 60 cm
Ø 60 cm - H 48 cm
8 x E14 40W

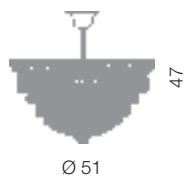

New Orleans sospensione Ø 51 cm
Ø 51 cm - H 47 cm
6 x E14 40W

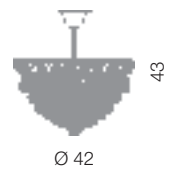

New Orleans sospensione Ø 42 cm
Ø 42 cm - H 43 cm
4 x E14 40W



New Orleans sospensione Ø 30 cm
Ø 31 cm - H 39 cm
3 x E14 40W

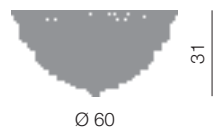

New Orleans plafoniera Ø 60 cm
Ø 60 cm - H 31 cm
8 x E14 40W



New Orleans plafoniera Ø 50 cm
Ø 51 cm - H 29 cm
6 x E14 40W

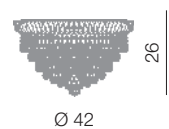

New Orleans plafoniera Ø 40 cm
Ø 42 cm - H 26 cm
4 x E14 40W

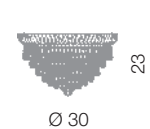

New Orleans plafoniera Ø 30 cm
Ø 30 cm - H 23 cm
3 x E14 40W

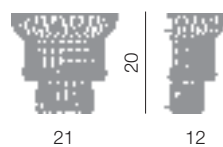

New Orleans parete 2L
L 21 cm - H 20 cm - SP 12 cm
2 x E14 40W

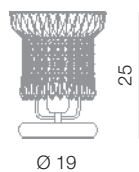

New Orleans tavolo 1L
Ø 19 cm - H 25 cm
1 x E27 40W



OSAKA



Osaka lampadario Impero MULTI Ø 85 cm
Ø 85 cm - H 335 cm
29 x E14 40W

Osaka lampadario Impero Ø 80 cm
Ø 85 cm - H 127 cm
15 x E14 40W



OSAKA





Osaka plafoniera Ø 60 cm
Ø 66 cm - H 45 cm
8 x E14 40W

Osaka sospensione Ø 50 cm
Ø 54 cm - H 55 cm
6 x E14 40W



OSAKA

  E14 40W



Collezione di lampade stile Classico con cristalli al 24% di PbO e disponibili con montatura dorata 24 KT o nichel.

Lighting collection Classico style with lead crystal 24% PbO pendants, available with 24 KT gold or nickel plated frame.

Collection des lustres style Classique avec cristaux au 24% de PbO et disponibles avec finition dorée ou nickelée.

Colección de lámparas estilo clásico con cristal al 24 % de PbO, disponible en baño de oro 24 KT o níquel.



Osaka parete 2L
L 20 cm - H 23 cm - SP 13 cm
2 x E14 40W

Osaka tavolo 1L
Ø 18 cm - H 28 cm
1 x E27 40W

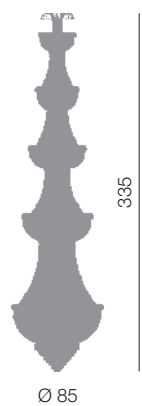

Osaka lampadario Impero MULTI Ø 85 cm
Ø 85 cm - H 335 cm
29 x E14 40W

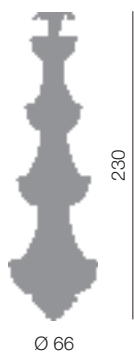

Osaka lampadario Impero MULTI Ø 66 cm
Ø 66 cm - H 230 cm
21 x E14 40W



Osaka lampadario Impero Ø 120 cm
Ø 124 cm - H 177 cm
20 x E14 40W

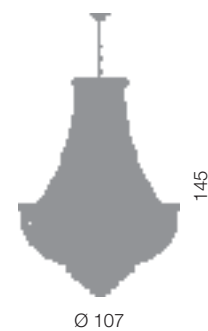

Osaka lampadario Impero Ø 100 cm
Ø 107 cm - H 145 cm
18 x E14 40W

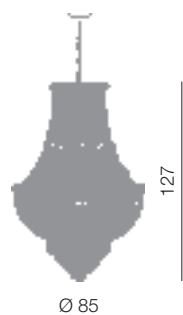

Osaka lampadario Impero Ø 80 cm
Ø 85 cm - H 127 cm
15 x E14 40W

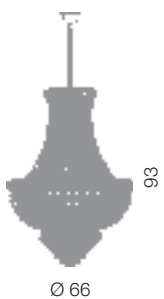

Osaka lampadario Impero Ø 60 cm
Ø 66 cm - H 93 cm
9 x E14 40W

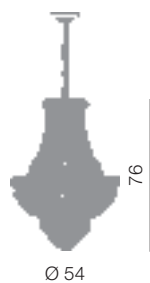

Osaka lampadario Impero Ø 50 cm
Ø 54 cm - H 76 cm
7 x E14 40W

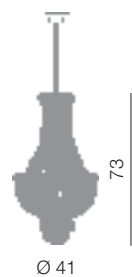

Osaka lampadario Impero Ø 40 cm
Ø 41 cm - H 73 cm
6 x E14 40W



Osaka lampadario Impero Ø 30 cm
Ø 35 cm - H 61 cm
5 x E14 40W

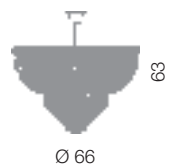

Osaka sospensione Ø 60 cm
Ø 66 cm - H 63 cm
8 x E14 40W

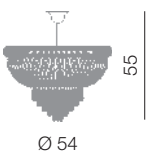

Osaka sospensione Ø 50 cm
Ø 54 cm - H 55 cm
6 x E14 40W



Osaka sospensione Ø 40 cm
Ø 41 cm - H 52 cm
4 x E14 40W

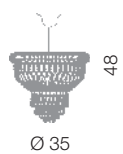

Osaka sospensione Ø 30 cm
Ø 35 cm - H 48 cm
3 x E14 40W

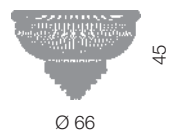

Osaka plafoniera Ø 60 cm
Ø 66 cm - H 45 cm
8 x E14 40W

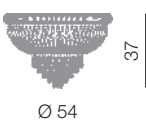

Osaka plafoniera Ø 50 cm
Ø 54 cm - H 37 cm
6 x E14 40W

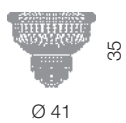

Osaka plafoniera Ø 40 cm
Ø 41 cm - H 35 cm
4 x E14 40W

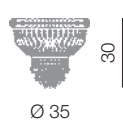

Osaka plafoniera Ø 30 cm
Ø 35 cm - H 30 cm
3 x E14 40W

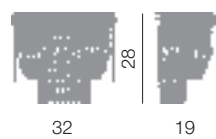

Osaka parete 3L
L 32 cm - H 28 cm - SP 19 cm
3 x E14 40W

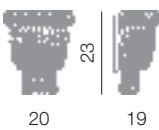

Osaka parete 2L
L 20 cm - H 23 cm - SP 19 cm
2 x E14 40W

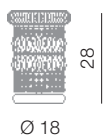

Osaka tavolo 1L
Ø 18 cm - H 28 cm
1 x E27 40W



PEGASO



Pegaso sospensione Ø 40 cm
Ø 41 cm - H 45 cm
4 x E14 40W

Pegaso lampadario Impero Ø 80 cm
Ø 107 cm - H 100 cm
19 x E14 40W



PEGASO





Pegaso plafoniera Ø 80 cm
Ø 80 cm - H 48 cm
12 x E14 40W

Pegaso plafoniera Ø 80 cm
Ø 80 cm - H 48 cm
12 x E14 40W



PEGASO

  E14 40W



Collezione di lampade stile Classico con cristalli al 24% di PbO e disponibili con montatura dorata 24 KT o nichel.

Lighting collection Classico style with lead crystal 24% PbO pendants, available with 24 KT gold or nickel plated frame.

Collection des lustres style Classique avec cristaux au 24% de PbO et disponibles avec finition dorée ou nickelée.

Colección de lámparas estilo clásico con cristal al 24 % de PbO, disponible en baño de oro 24 KT o níquel.



Pegaso parete 2L
L 17 cm - H 21 cm - SP 10 cm
2 x E14 40W

Pegaso tavolo 1L
Ø 15 cm - H 26 cm
1 x E27 40W

Pegaso tavolo 2L
Ø 31 cm - H 53 cm
2 x E14 40W

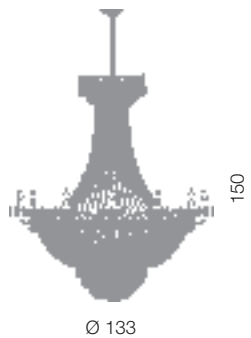

Pegaso lampadario Impero Ø 100 cm
Ø 133 cm - H 150 cm
28 x E14 40W

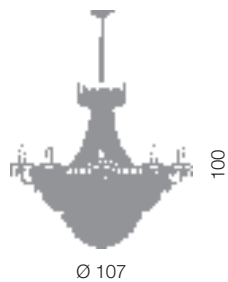

Pegaso lampadario Impero Ø 80 cm
Ø 107 cm - H 100 cm
19 x E14 40W



Pegaso lampadario Impero Ø 55 cm
Ø 80 cm - H 81 cm
13 x E14 40W

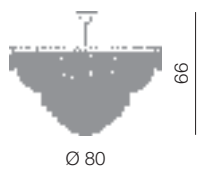

Pegaso sospensione Ø 80 cm
Ø 80 cm - H 66 cm
12 x E14 40W

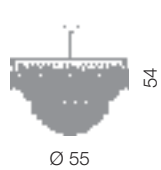

Pegaso sospensione Ø 55 cm
Ø 55 cm - H 54 cm
9 x E14 40W



Pegaso sospensione Ø 40 cm
Ø 41 cm - H 45 cm
4 x E14 40W

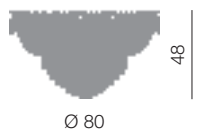

Pegaso plafoniera Ø 80 cm
Ø 80 cm - H 48 cm
12 x E14 40W



Pegaso plafoniera Ø 55 cm
Ø 54 cm - H 36 cm
9 x E14 40W

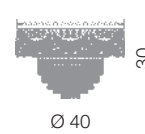

Pegaso plafoniera Ø 40 cm
Ø 40 cm - H 30 cm
4 x E14 40W

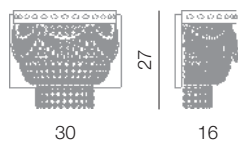

Pegaso parete 3L
L 30 cm - H 27 cm - SP 16 cm
3 x E14 40W

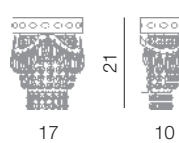

Pegaso parete 2L
L 17 cm - H 21 cm - SP 10 cm
2 x E14 40W

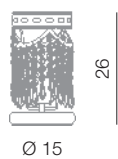

Pegaso tavolo 1L
Ø 15 cm - H 26 cm
1 x E27 40W



Pegaso tavolo 2L
Ø 31 cm - H 53 cm
2 x E14 40W

ROMA



Roma sospensione Ø 30 cm
Ø 33 cm - H 41 cm
3 x E14 40W

Roma lampadario Impero Ø 60 cm
Ø 64 cm - H 86 cm
9 x E14 40W



ROMA





Roma parete 2L
L 18 cm - H 18 cm - SP 12 cm
2 x E14 40W

Roma plafoniera Ø 50 cm
Ø 54 cm - H 33 cm
6 x E14 max 40W



ROMA

  E14 40W



Collezione di lampade stile Classico con cristalli al 24% di PbO e disponibili con montatura dorata 24 KT o nichel.

Lighting collection Classico style with lead crystal 24% PbO pendants, available with 24 KT gold or nickel plated frame.

Collection des lustres style Classique avec cristaux au 24% de PbO et disponibles avec finition dorée ou nickelée.

Colección de lámparas estilo clásico con cristal al 24 % de PbO, disponible en baño de oro 24 KT o níquel.



Roma tavolo 1L
Ø 17 cm - H 24 cm
1 x E27 40W

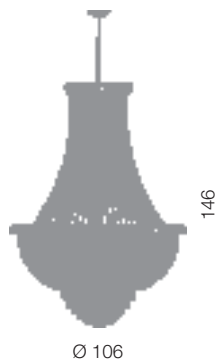

Roma lampadario Impero Ø 100 cm
Ø 106 cm - H 146 cm
18 x E14 40W

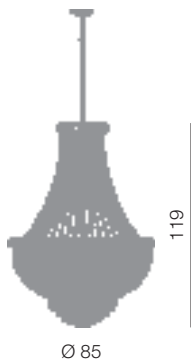

Roma lampadario Impero Ø 80 cm
Ø 85 cm - H 119 cm
15 x E14 40W

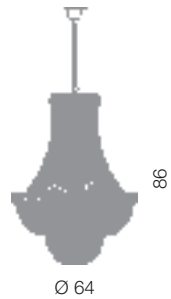

Roma lampadario Impero Ø 60 cm
Ø 64 cm - H 86 cm
9 x E14 40W

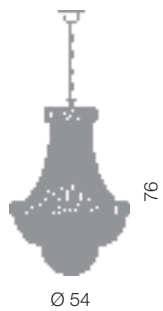

Roma lampadario Impero Ø 50 cm
Ø 54 cm - H 76 cm
7 x E14 40W

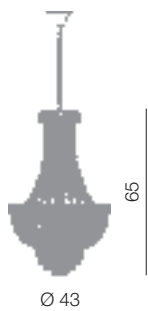

Roma lampadario Impero Ø 40 cm
Ø 43 cm - H 66 cm
6 x E14 40W



Roma lampadario Impero Ø 30 cm
Ø 33 cm - H 54 cm
5 x E14 40W

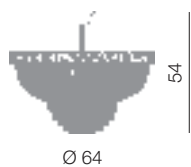

Roma sospensione Ø 60 cm
Ø 64 cm - H 54 cm
8 x E14 40W

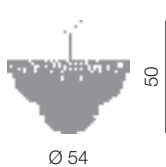

Roma sospensione Ø 50 cm
Ø 54 cm - H 50 cm
6 x E14 40W

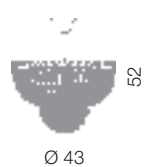

Roma sospensione Ø 40 cm
Ø 43 cm - H 52 cm
4 x E14 40W

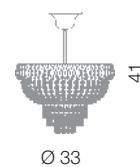

Roma sospensione Ø 30 cm
Ø 33 cm - H 41 cm
3 x E14 40W



Roma plafoniera Ø 60 cm
Ø 64 cm - H 37 cm
8 x E14 40W

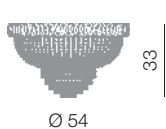

Roma plafoniera Ø 50 cm
Ø 54 cm - H 33 cm
6 x E14 40W



Roma plafoniera Ø 40 cm
Ø 43 cm - H 29 cm
4 x E14 40W



Roma plafoniera Ø 30 cm
Ø 33 cm - H 23 cm
3 x E14 40W

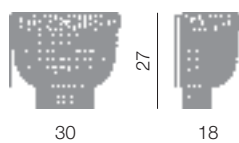

Roma parete 3L
L 30 cm - H 27 cm - SP 18 cm
3 x E14 40W

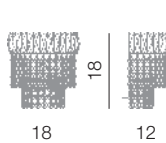

Roma parete 2L
L 18 cm - H 18 cm - SP 12 cm
2 x E14 40W

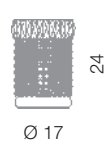

Roma tavolo 1L
Ø 17 cm - H 24 cm
1 x E27 40W



SETTAT



Settat lampadario **Impero** Ø 60 cm
Ø 61 cm - H 80 cm
9 x E14 40W

Settat lampadario Impero Ø 50 cm
Ø 51 cm - H 75 cm
7 x E14 40W







SETTAT





Settat sospensione Ø 50 cm
Ø 51 cm - H 51 cm
6 x E14 40W

Settat plafoniera Ø 40 cm
Ø 41 cm - H 28 cm
4 x E14 40W



SETTAT

  E14 40W



Collezione di lampade stile Classico con cristalli al 24% di PbO e disponibili con montatura dorata 24 KT o nichel.

Lighting collection Classico style with lead crystal 24% PbO pendants, available with 24 KT gold or nickel plated frame.

Collection des lustres style Classique avec cristaux au 24% de PbO et disponibles avec finition dorée ou nickelée.

Colección de lámparas estilo clásico con cristal al 24 % de PbO, disponible en baño de oro 24 KT o níquel.



Settat parete 2L
L 16 cm - H 18 cm - SP 12 cm
2 x E14 40W

Settat tavolo 1L
Ø 16 cm - H 23 cm
1 x E27 40W

Settat tavolo 2L
Ø 27 cm - H 41 cm
2 x E14 40W

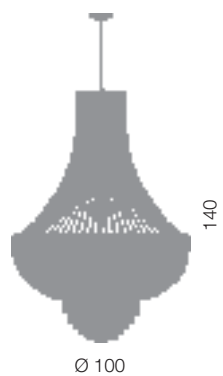

Settat lampadario Impero Ø 100 cm
Ø 100 cm - H 140 cm
18 x E14 40W

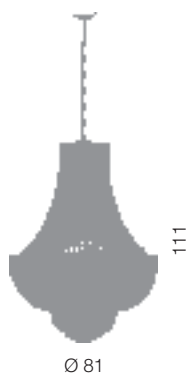

Settat lampadario Impero Ø 80 cm
Ø 81 cm - H 111 cm
15 x E14 40W

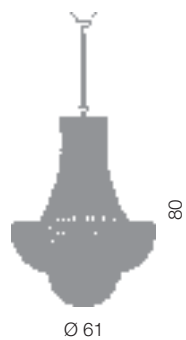

Settat lampadario Impero Ø 60 cm
Ø 61 cm - H 80 cm
9 x E14 40W

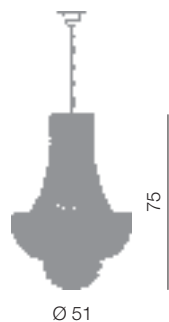

Settat lampadario Impero Ø 50 cm
Ø 51 cm - H 75 cm
7 x E14 40W



Settat lampadario Impero Ø 40 cm
Ø 41 cm - H 64 cm
6 x E14 40W



Settat lampadario Impero Ø 30 cm
Ø 31 cm - H 52 cm
5 x E14 40W

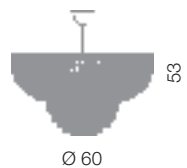

Settat sospensione Ø 60 cm
Ø 60 cm - H 53 cm
8 x E14 40W

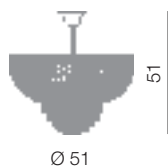

Settat sospensione Ø 50 cm
Ø 51 cm - H 51 cm
6 x E14 40W

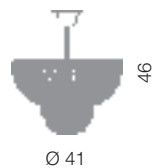

Settat sospensione Ø 40 cm
Ø 41 cm - H 46 cm
4 x E14 40W

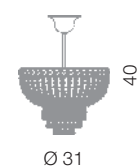

Settat sospensione Ø 30 cm
Ø 31 cm - H 40 cm
3 x E14 40W

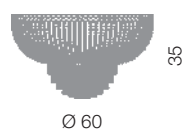

Settat plafoniera Ø 60 cm
Ø 60 cm - H 35 cm
8 x E14 40W



Settat plafoniera Ø 50 cm
Ø 51 cm - H 33 cm
6 x E14 40W



Settat plafoniera Ø 40 cm
Ø 41 cm - H 28 cm
4 x E14 40W

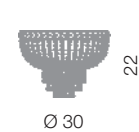

Settat plafoniera Ø 30 cm
Ø 30 cm - H 22 cm
3 x E14 40W

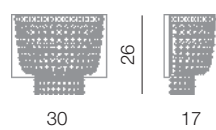

Settat parete 3L
L 30 cm - H 26 cm - SP 17 cm
3 x E14 40W

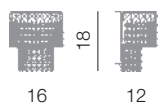

Settat parete 2L
L 16 cm - H 18 cm - SP 12 cm
2 x E14 40W

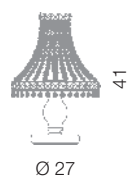

Settat tavolo 2L
Ø 27 cm - H 41 cm
2 x E14 40W

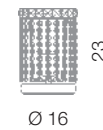

Settat tavolo 1L
Ø 16 cm - H 23 cm
1 x E27 40W



TWISTER



Twister plafoniera Ø 60 cm
Ø 60 cm - H 400 cm
20 x E14 40W

Twister plafoniera Ø 40 cm
Ø 42 cm - H 200 cm
12 x E14 40W



TWISTER



Twister plafoniera Ø 40 cm
Ø 42 cm - H 35 cm
5 x E14 40W

Twister plafoniera Ø 40 cm
Ø 42 cm - H 200 cm
12 x E14 40W



TWISTER



Twister parete 2L
L 22 cm - H 19 cm - SP 14 cm
2 x E14 40W

Twister plafoniera Ø 40 cm
Ø 42 cm - H 50 cm
7 x E14 40W



TWISTER



Twister tavolo 1L
Ø 15 cm - H 22 cm
1 x E27 40W

TWISTER



Collezione di lampade stile Classico con cristalli al 24% di PbO e disponibili con montatura dorata 24 KT o nichel.

Lighting collection Classico style with lead crystal 24% PbO pendants, available with 24 KT gold or nickel plated frame.

Collection des lustres style Classique avec cristaux au 24% de PbO et disponibles avec finition dorée ou nickelée.

Colección de lámparas estilo clásico con cristal al 24 % de PbO, disponible en baño de oro 24 KT o níquel.

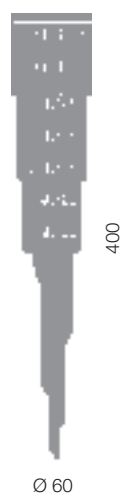

Twister plafoniera Ø 60 cm
Ø 60 cm - H 400 cm
20 x E14 40W

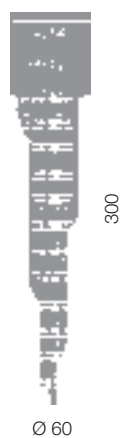

Twister plafoniera Ø 60 cm
Ø 60 cm - H 300 cm
20 x E14 40W



Twister plafoniera Ø 40 cm
Ø 42 cm - H 200 cm
12 x E14 40W

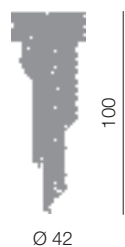

Twister plafoniera Ø 40 cm
Ø 42 cm - H 100 cm
12 x E14 40W



Twister plafoniera Ø 40 cm
Ø 42 cm - H 50 cm
7 x E14 40W

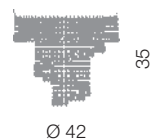

Twister plafoniera Ø 40 cm
Ø 42 cm - H 35 cm
5 x E14 40W

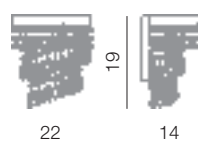

Twister parete 2L
L 22 cm - H 19 cm - SP 14 cm
2 x E14 40W



Twister tavolo 1L
Ø 15 cm - H 22 cm
1 x E27 40W

SALISBURGO



Salisburgo lampadario 12+6L
Ø 112 cm - H 70 cm
18 x E14 40W

Salisburgo lampadario 8+4L
Ø 89 cm - H 61 cm
12 x E14 40W



SALISBURGO



Salisburgo lampadario 6+3L
Ø 67 cm - H 56 cm
9 x E14 40W



SALISBURGO



Salisburgo parete 2L
L 33 cm - H 27 cm - SP 18 cm
2 x E14 40W

SALISBURGO

Modello depositato / Registered design / modèle déposé / artículo patentado



Collezione di lampade stile Classico con cristalli al 24% di PbO e disponibili con montatura dorata 24 KT o nichel.

Lighting collection Classico style with lead crystal 24% PbO pendants, available with 24 KT gold or nickel plated frame.

Collection des lustres style Classique avec cristaux au 24% de PbO et disponibles avec finition dorée ou nickelée.

Colección de lámparas estilo clásico con cristal al 24% de PbO, disponible en baño de oro 24 KT o níquel.

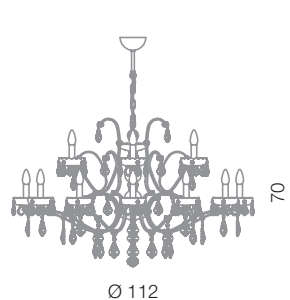

Salisburgo lampadario 12+6L
Ø 112 cm - H 70 cm
18 x E14 40W

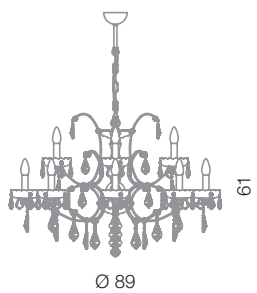

Salisburgo lampadario 8+4L
Ø 89 cm - H 61 cm
12 x E14 40W



Salisburgo lampadario 6+3L
Ø 67 cm - H 56 cm
9 x E14 40W

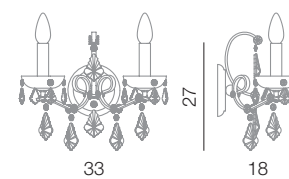

Salisburgo parete 2L
L 33 cm - H 27 cm - SP 18 cm
2 x E14 40W

GRAZ



Graz lampadario 16L
L 117 cm - H 37 cm - SP 53 cm
16 x E14 40W



GRAZ



Graz lampadario 12L
L 117 cm - H 37 cm - SP 53 cm
12 x E14 40W

GRAZ

Modello depositato / Registered design / modèle déposé / artículo patentado

 E14 40W



Collezione di lampade in stile "Maria Theresa" classico con cristalli al 24% PbO. Disponibili con montatura dorata 24 KT o nichel.

Lamp collection in classic "Maria Theresa" style with lead crystal 24% Pbo pendants, available with 24 KT gold or nickel plated frame.

Collection de lustres en style classique "Maria Theresa" avec pendants en cristal 24% PbO. Disponibles avec structure dorée 24 Kt ou nickelée.

Colección de lámparas de estilo "Maria Theresa" con cristal al 24 % de PbO. Disponibles en baño de oro 24 KT o níquel.

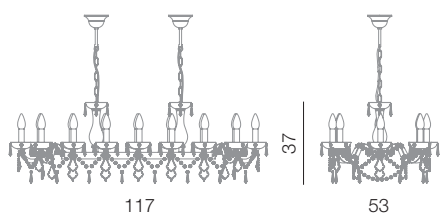

Graz lampadario 16L
L 117 cm - H 37 cm - SP 53 cm
16 x E14 40W

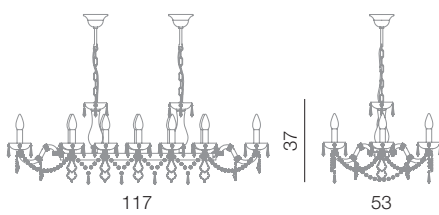

Graz lampadario 12L
L 117 cm - H 37 cm - SP 53 cm
12 x E14 40W

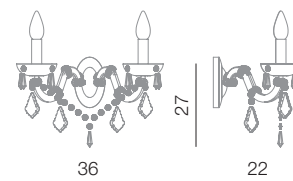

Graz parete 2L
L 36 cm - H 27 cm - SP 22 cm
2 x E14 40W



INNSBRUCK



Innsbruck lampadario 8+4L
Ø 73 cm - H 66 cm
12 x E14 40W

Innsbruck lampadario 12+6L
Ø 96 cm - H 90 cm
18 x E14 40W



INNSBRUCK



Innsbruck lampadario 6L
Ø 73 cm - H 66 cm
6 x E14 40W

INNSBRUCK

Modello depositato / Registered design / modèle déposé / artículo patentado

 E14 40W



Collezione di lampade in stile "Maria Theresa" classico con cristalli al 24% PbO. Disponibili con montatura dorata 24 KT o nichel.

Lamp collection in classic "Maria Theresa" style with lead crystal 24% PbO pendants, available with 24 KT gold or nickel plated frame.

Collection de lustres en style classique "Maria Theresa" avec pendants en cristal 24% PbO. Disponibles avec structure dorée 24 Kt ou nickelée.

Colección de lámparas de estilo "Maria Theresa" con cristal al 24 % de PbO. Disponibles en baño de oro 24 KT o níquel.

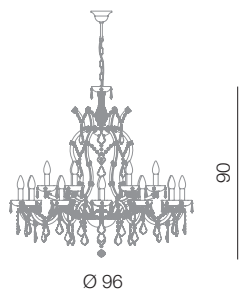

Innsbruck lampadario 12+6L
Ø 96 cm - H 90 cm
18 x E14 40W



Innsbruck lampadario 8+4L
Ø 73 cm - H 66 cm
12 x E14 40W



Innsbruck lampadario 6L
Ø 73 cm - H 66 cm
6 x E14 40W

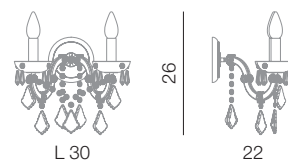

Innsbruck parete 2L
L 30 cm - H 26 cm - SP 22 cm
2 x E14 40W



LIENZ



Lienz lampadario 12+6L
Ø 68 cm - H 57 cm
18 x E14 40W

Lienz lampadario 20+10L
Ø 93 cm - H 72 cm
30 x E14 40W



LIENZ



Lienz lampadario 10L
Ø 59 cm - H 47 cm
10 x E14 40W

https:

re

Lienz lampadario 8L
Ø 59 cm - H 47 cm
8 x E14 40W





Lienz parete 2L
L 27 cm - H 25 cm - SP 19 cm
2 x E14 40W



Lienz tavolo 1L
Ø 14 cm - H 28 cm
1 x E14 40W

LIENZ

Modello depositato / Registered design / modèle déposé / artículo patentado

 E14 40W



Collezione di lampade in stile "Maria Theresa" classico con cristalli al 24% PbO. Disponibili con montatura dorata 24 KT o nichel.

Lamp collection in classic "Maria Theresa" style with lead crystal 24% Pbo pendants, available with 24 KT gold or nickel plated frame.

Collection de lustres en style "Maria Theresa" classique, avec pendants en cristal 24% PbO. Disponibles avec structure dorée 24 Kt ou nickelée.

Colección de lámparas de estilo "Maria Theresa" clásico con cristal al 24% de PbO. Disponibles en baño de oro 24 KT o níquel.



Lienz lampadario 20+10L
Ø 93 cm - H 72 cm
30 x E14 40W



Lienz lampadario 16+8L
Ø 89 cm - H 71 cm
24 x E14 40W



Lienz lampadario 12+6L
Ø 68 cm - H 57 cm
18 x E14 40W



Lienz lampadario 10+5L
Ø 68 cm - H 57 cm
15 x E14 40W



Lienz lampadario 10L
Ø 59 cm - H 47 cm
10 x E14 40W



Lienz lampadario 8+4L
Ø 68 cm - H 60 cm
12 x E14 40W



Lienz lampadario 8L
Ø 59 cm - H 47 cm
8 x E14 40W

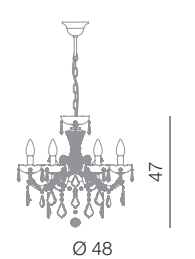

Lienz lampadario 6L
Ø 48 cm - H 47 cm
6 x E14 40W



Lienz lampadario 5L
Ø 47 cm - H 45 cm
5 x E14 40W



Lienz lampadario 3L
Ø 44 cm - H 45 cm
3 x E14 40W

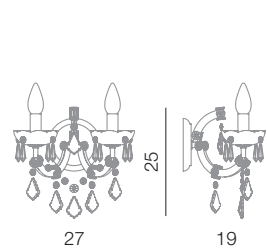

Lienz parete 2L
L 27 cm - H 25 cm - SP 19 cm
2 x E14 40W



Lienz tavolo 1L
Ø 14 cm - H 28 cm
1 x E14 40W

PARALUMI

Tutte le linee di lampadari Cristallo possono utilizzare i seguenti paralumi lisci o plissettati.

All chandeliers included in our "Cristal" collection can be equipped with smooth or "plissé" lampshades.

Toutes les lignes de lustres collection "Cristal" peuvent avoir les abat-jours lisse ou plissé.

Todas las colecciones de lámparas de cristal pueden utilizar las siguientes pantallas lisas o plisadas.

PLO ORGANZA



Nero



Rosso veneziano



Lilla



Bianco



Oro antico

PLC COTONE



Nero



Rosso veneziano



Lilla



Bianco

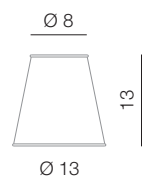



...eleganza



e fascino senza tempo

Murano Lab 1291 è il nuovo progetto di Voltolina, azienda leader nel settore dell'illuminazione di lusso.

Una vetreria dove un abile team di maestri vetrai crea lampadari su misura, facendo in modo che le varianti di design, dimensioni e colori siano pressochè infinite.

Come in un atelier sartoriale, anche le esigenze più particolari dei clienti possono essere soddisfatte. Murano Lab 1291 è sinonimo di qualità e storia, a partire dal nome: 1291 non è solo un numero, ma è la testimonianza dell'autentiche radici veneziane dell'azienda Voltolina.

1291 è la data in cui vennero trasferite le vetrerie da Venezia a Murano, per poter delimitare il pericolo d'incendio alla sola isola e, proprio come allora, i prodotti di Murano Lab 1291 sono realizzati interamente a mano, soffiati e lavorati da maestri muranesi affiancati da designer, tra i quali Lenarda e Rasmussen, che collaborano da tempo con Voltolina.

"Il potersi circondare di prodotti interamente fatti a mano, unitamente alla ricerca di un livello qualitativo sempre più elevato – dice Andrea Voltolina, Amministratore Unico dell'azienda - è sinonimo di lusso, che permette al nostro cliente di vivere delle emozioni positive all'interno della propria abitazione.

Tutto questo per noi è il lusso, ed è proprio nei momenti di difficoltà economica e recessione, che cresce l'appeal nei confronti di un lusso inteso come gratificazione e soddisfazione personale."

All'interno di Murano Lab 1291, il cliente ha la possibilità di scegliere il colore e le dimensioni del proprio lampadario, avvalendosi della capacità dei maestri muranesi che fondano il loro know-how su una base millenaria di arte del vetro.

Il post vendita si basa su un team di allestitori che assemblano il lampadario direttamente a casa del cliente, in qualunque paese del mondo.

Uno dei primi gioielli di Murano Lab 1291 è Rialto, realizzato in collaborazione con il designer Alessandro Lenarda.

Brian Rasmussen è invece artefice della lampada Medusa che è un perfetto connubio tra la millenaria tradizione vetraria muranese ed il design moderno e contemporaneo.

MURANO LAB

collection news 2011 (GERMAN)

Murano Lab 1291 ist das neueste Project von Voltolina der Hersteller führender Marken in der Luxus-Bereich Beleuchtung. Das Studio besteht aus einem Team von sehr erfahrenen Glasbläsern, die kundenspezifische Kronleuchter, Ihrem Design, Abmessungen und Farben herstellt für eine nahezu unendliche Anzahl von Interpretationen. Der professionelle Workshop sorgt auch dafür das die anspruchsvollsten Projekte durchgeführt werden können. Murano Lab 1291 ist ein Name für Qualität und Tradition. 1291 ist nicht nur eine Nummer, aber auch die Geschichte der echten venezianischen Wurzeln von Voltolina. 1291 ist das Datum, wenn die Glasbläser Produktion von Venedig nach Murano verlegt wurde, um die Brandgefahr zu entfliehen. Wie damals wird hier in Partnerschaft mit unseren Designern, unter ihnen sind Lenarda und Rasmussen, der bereits mit der Marke Voltolina seit vielen Jahren arbeiten ,vollständig in Traditioneller Arbeit die Leuchter gefertigt. "Sich mit komplett von Hand hergestellten Produkten und immer auf der Suche nach einer immer höheren Standard der Produktion". Sagt Andrea Voltolina, Geschäftsführer des Unternehmens - "ist ein Zeichen von einzigartiger Qualität, dass unsere Kunden in Ihren eigenen Häusern genießen können. All dies repräsentiert und steht für Luxus, angesichts der aktuellen wirtschaftlichen Schwierigkeiten und der Rezession bietet es ein persönliches Statement von Komfort und Qualität. Murano Lab 1291 erlaubt den Kunden die Wahl der Größen, Formen und Farben und gibt Ihnen das Vertrauen in die Fähigkeit der Murano Glasbläser, die Ihre Erfahrungen über Generationen weitergeben. Professioneller Kundenservice ist auch da, wenn die Kronleuchter durch ein Aufbau Team im Haus aufgebaut werden müssen, überall auf der Welt. Eines unser ersten Erfolge des Murano Lab 1291 ist das "Rialto" - das Ergebnis der Vision der Designer Alessandro Lenarda. Brian Rasmussen ist der Creative Designer der "Medusa"-Serie - ein perfektes Gleichgewicht der alten Traditionen aus Murano-Glas, im modernen und zeitgenössischen Design.

MURANO LAB

collection news 2011 (ENGLISH)

Murano Lab 1291 is the latest offering from Voltolina, brand leaders in the luxury lighting sector. Consisting of a glass studio with a team of highly-experienced glass masters producing custom lighting, their flexibility of design, dimensions and colours ensures a virtually infinite number of interpretations. With a workshop dedicated to custom commissions, even the most demanding projects can be accomplished. Murano Lab 1291 is synonymous with both quality and tradition, beginning with the number: 1291 is not just a number, but also evidence of the genuine Venetian roots of the Voltolina brand. 1291 is the date when the glass furnaces were transferred from Venice to Murano, in order to minimise the danger of fire to Venice, and now, as then, the glass products made by Murano 1291 are entirely made by hand, blown and worked by Muranesi glass masters, in partnership with designers, amongst whom are Lenarda and Rasmussen, who have already worked with the Voltolina brand for many years. "To be able to surround ourselves with completely hand-made products, and always in pursuit of an ever higher standard of production" – says Andrea Voltolina, managing director of the company – "is a sign of unrivalled quality, allowing our customers to enjoy a fantastic, positive experience within their homes". All this represents luxury, in the face of the current economic difficulties and recession, offering the individual a personal statement of comfort and quality. Murano Lab 1291 allow the client to choose the dimensions and the colour of the chandelier, trusting the skills of the Murano glass masters, who base their work on experience passed down through generations of glass blowers. Customer service is further enhanced by an assembly team who will visit the household in any country in the world and install the chandelier. On of the first ewels of Murano Lab 1291 is the "Rialto" - the result of the vision of designer Alessandro Lenarda. Brian Rasmussen is, similarly, mastermind of the "Medusa" series - a perfect balance of the ancient Murano glass traditions, with modern and contemporary design.

MURANO LAB

collection news 2011 (FRENCH)

Murano Lab 1291 est le nouveau projet de Voltolina, entreprise leader dans le secteur de l'éclairage de luxe une verrerie où une équipe habile de maîtres verriers crée des lustres sur mesure, faisant en sorte que les variations de design, de dimensions et de couleurs soient pour ainsi dire infinies. Comme dans un atelier de couture, les exigences les plus spécifiques des clients peuvent être satisfaites. Murano Lab 1291 est synonyme de qualité et d'histoire, à commencer par son nom: 1291 n'est pas seulement un nombre mais aussi le témoignage des racines authentiquement vénitiennes de l'entreprise Voltolina.

1291 est la date à laquelle furent transférées les verreries de Venise à Murano, pour pouvoir limiter le risque d'incendie au seul réimètre de l'île, et exactement comme à l'époque, les produits de Murano Lab 1291 sont réalisés entièrement à la main, soufflés et travaillés par des maîtres muranais associés à des designers, parmi lesquels Lenarda et Rasmussen, qui collaborent depuis longtemps avec Voltolina. "La capacité à s'entourer de produits entièrement faits main, associée à la recherche d'une qualité toujours plus élevée, - dit Andrea Voltolina, unique administrateur de l'entreprise-, est synonyme de luxe, qui permet à notre client de vivre des émotions positives à l'intérieur de sa propre habitation".

C'est tout cela le luxe pour nous, et c'est justement dans les moments de difficultés économiques et de récession qu'augmentent l'"appel" vis à vis du luxe, perçu comme une gratification et une satisfactions personnelles.

À l'intérieur de Murano Lab 1291, le client a la possibilité de choisir la couleur et les dimensions de son lustre, grâce à la capacité des maîtres de Murano, qui fondent leur savoir-faire sur des bases millénaires d'art du verre.

Le service après-vente se base sur une équipe de techniciens qui assemblent le lustre directement chez le client, quel que soit l'endroit du monde. Un des premiers bijoux de Murano est Rialto, réalisé en collaboration avec le designer Alessandro Lenarda.

Brian Rasmussen et lui l'instigateur de la lampe Medusa, qui est une parfaite combinaison entre la tradition millénaire du verre de Murano et le design moderne et contemporain

MURANO LAB

collection news 2011 (SPANISH)

Murano Lab 1291 es el nuevo proyecto de Voltolina, empresa líder en el sector de la iluminación de lujo.

Una empresa artesanal vidriera donde un hábil equipo de maestros vidrieros crea lámparas a medida, haciendo que las variantes de diseño, dimensiones y colores sean casi infinitas. Como en una sastrería, donde las exigencias más particulares de los clientes pueden ser satisfechas. Murano Lab 1291 es sinónimo de calidad e historia, a partir del nombre: 1291 no es sólo un número, sino el testimonio de las auténticas raíces venecianas de la empresa Voltolina.

1291 es el año en el cual se trasladaron las fábricas de vidrio artesanal de Venecia a Murano, para poder delimitar el peligro de incendio a una sola isla, y como entonces, los productos de Murano Lab 1291 están hechos completamente a mano, soplados y elaborados por los maestros muraneses apoyados por los diseñadores, entre ellos Lenarda y Rasmussen, que colaboran hace tiempo con Voltolina. "El poderse rodear de productos elaborados completamente a mano, unido a la búsqueda de un nivel cualitativo siempre más elevado - dice Andrea Voltolina, Administrador único de la sociedad - es sinónimo de lujo, que permite a nuestro cliente vivir emociones positivas dentro de la propia vivienda".

Todo esto para nosotros es el lujo, y es justo en los momentos de dificultad económica y recesión, que crece el sentimiento de un lujo entendido como gratificación y satisfacción personal. En Murano Lab 1291, el cliente tiene posibilidad de escoger el color y la dimensión de la lámpara, valiéndose de la capacidad de los maestros muraneses que basan su saber hacer sobre una milenaria tradición en el artesanía del vidrio. El servicio post-venta se basa en un equipo de montadores que ensamblan la lámpara directamente en casa del cliente, en cualquier país del mundo.

Una de las primeras joyas de Murano Lab 1291 es Rialto, realizado en colaboración con el diseñador Alessandro Lenarda.

Por su parte Brian Rasmussen es el artífice de la lámpara Medusa, que es un perfecto nexo de unión entre la milenaria tradición muranesa y el diseño moderno y contemporáneo.



MURANO LAB

collection news 2011 (CHINESE)

Murano Lab 1291 是意大利照明灯具行业的领先公司 Votolima 的一个新品牌。

这是家拥有一个玻璃制造专家团队的玻璃工厂。生产定制的原型产品。提供层出不穷的各种设计、尺寸和颜色选择。

就像一位服装设计师的工作量一样，他们能满足最苛刻的客户需求。Murano Lab 1291 是品质和传统的代名词。而此传统始于百年中的这个年代。1291 不仅是一个数字，更是 Votolima 公司对于威尼斯传统的见证。

正是在 1291 年，威尼斯将所有玻璃厂迁往穆拉诺。这样即使发生火灾，也只会局限在这个小岛上了。而就像当时一样，Murano Lab 1291 的产品完全是手工制作，由穆拉诺的玻璃工匠吹制、加工，并由像 Lenarda 和 Rasmussen 这样的设计师设计。他们与 Votolima 保持着长久的合作关系。“我们的产品都是手工制作的，而且对品质有着精益求精的追求——公司的常务董事 Andrea Votolima 这样说道——它们是奢华的代名词。使我们的顾客能够在家里感受到 穆拉诺的精髓。

对我们来说这些都是奢华的，而正是在当今这个经济衰退的艰难时刻，奢华对人们有着越来越大的吸引力，因为它能给人带来满足感和喜悦。”

在 Murano Lab 1291，顾客可以选择自己喜欢的吊灯颜色和尺寸，充分利用穆拉诺的玻璃工匠对其对玻璃传统工艺的专业知识，所具备的精湛技术。公司的销售基于一个安装团队，他们会将吊灯直接安装到顾客的家中，无论顾客身处世界何处。

Murano Lab 1291 的第一批作品是与设计师 Alessandro Lenarda 一同合作完成的 Rialto 系列。

Brian Rasmussen 则是 Medusa 系列灯具的设计师。这个系列将穆拉诺玻璃的悠久传统与时尚现代设计进行了完美的结合。

MURANO LAB

collection news 2011 (JAPAN)

Murano Lab 1291 は高級照明器具業界のリーダー的企業 VOLTOLIMA 社の新しいプロジェクトです。熟練したガラス職人チームが注文に応じたシャンデリアを製造。彼らの手によって生み出されるデザイン、サイズ、色のバリエーションはほぼ無限といえるでしょう。

オートクチュールと同様、お客様のどのようなご希望にもお応えいたします。Murano Lab 1291 は、その名称から明らかなように品質と歴史を重視するものです。1291 はただの数字ではありません。この数字は VOLTOLIMA 社が本格的にヴェネツィアに基盤を築いたことを示しています。

1291 年、万が一の火災の際に被害を最小限に抑えるためという理由で、ヴェネツィアの全てのガラス工場がムラーノ島に移転されました。つまり、火災による被害をムラーノ島内のみ止めようとする対策でした。その当時のガラス職人と同様に Murano Lab 1291 の製品は全てムラーノの職人たちの吹きガラス技法で作られています。製品のデザインは VOLTOLIMA 社と長年にわたる共同制作デザイナーのレナルダ氏、ラスマセン氏らによるものです。

「手作りの製品に囲まれた生活。同時に最高品質を追求することは、正に贅沢そのもの。こうやって個人の住まいの中で愛情豊かな生活をお客様に堪能していただく。これら全てが我が社にとっては有り余る贅沢。不景気なこの時期にこそ、個人の充足感・満足感という意味でのこのような中とりが人々の心を魅了するのではないか」とは代表取締役のアンドレア・ヴォルトリーナの言葉。

Murano Lab 1291 では、シャンデリアの希望のサイズと色をお客様自身に選んでいただき、千年もの歴史を誇るガラス伝統技法に熟練したムラーノの職人の手にその制作を委ねます。

アフターサービスとしてお客様のお住まいに直接伺い、シャンデリアの組み立てなどのお世話をするチームを世界各地に設置しています。

RIALTO は、Murano Lab 1291 の初商品の一つで、デザイナーのアlessandro レナルダ氏との共同開発によるものです。一方ブリアン・ラスマセン氏はランプ MEDUSA の創造者です。千年にわたるムラーノガラスの伝統と近代的デザインの完璧な融合が生み出した製品です。

MURANO LAB

collection news 2011 (RUSSIAN)

МураноЛаб 1291 – новый проект Вольтолина, компании-лидера на рынке осветительного оборудования. Это стекольное производство, где команда искусных мастеров-стеклодувов изготавливает люстры под заказ, используя бесконечное множество вариаций, когда каждое изделие является уникальным, не повторяя предыдущее ни в дизайне, ни в размерах, ни в цвете. Как в мастерской портного, мы стараемся индивидуально подойти к каждому клиенту и исполнить даже самые необычные требования и пожелания. МураноЛаб 1291 – это синоним качества и традиции, что отразилось и в самом названии: 1291 – не просто цифра, а свидетельство подлинности венецианских корней компании Вольтолина.

1291 – это год, когда все стекольные производства были перенесены из Венеции на Мурано, чтобы, в случае пожара, территория была ограничена одним островом. Как и в те времена, все изделия МураноЛаб 1291 производятся вручную. Муранские мастера выдувают и обрабатывают стекло, реализуя идеи дизайнеров Ленарда и Размуссена, которые уже на протяжении многих лет сотрудничают с компанией Вольтолина. «Возможность окружить себя уникальными предметами ручной работы гарантированно высочайшего качества - говорит управляющий компанией Андреа Вольтолина, -это синоним роскоши, позволяющей нашему клиенту получать у себя дома заряд позитивных эмоций. Именно так мы определяем “роскошь” в непростой период экономического спада, и вкладываем в это понятие личные эмоциональные ценности потребителя - удовлетворение и удовольствие». В МураноЛаб1291 у клиента есть возможность выбрать цвет и размеры своей люстры, опираясь на знания и опыт муранских мастеров, которые веками передают из поколения в поколение традиции обработки стекла. Постпродажное обслуживание включает возможность сборки люстры командой наших техников непосредственно у клиента в любой стране, в любой точке земного шара.

Одной из первых жемчужин МураноЛаб 1291 стала линия Риальто, созданная совместно с дизайнером Алессандро Ленарда. Брайан Размуссен, в свою очередь, является автором люстры Медуза, которая идеально считает в себе тысячелетние традиции Муранского стекла и современный дизайн.

MURANO LAB

collection news 2011 (ARAB)

يُعدّ "Murano Lab 1291" المشروع الجديد لشركة "Voltolina"، وهو شركة رائدة في قطاع الإضاءة الفخمة. إنه مصنع للزجاج وبه يقوم فريقاً ماهراً من المتخصصين في صناعة الزجاج بالتأخر كريات حسب الطلب بشكل يجعل الاختلافات في التصميم والأبعاد والألوان تكاد لا تنتهي. كما هو الحال في أتيليه الأزياء من الممكن تلبية الاحتياجات حتى الأكثر خصوصية للعملاء. يُعدّ "Murano Lab 1291" مرادفاً للجودة والتاريخ بدءاً من الاسم. 1291 ليس فقط رقفاً بل هو شهادة على الجودة الأصيلة الموروثية لشركة "Voltolina".

1291 هو التاريخ الذي تم فيه نقل مصانع الزجاج من فينيسيا إلى مورانو من أجل تجنب خطر الحرائق بالجزيرة الواحدة، وبالطبع كما كان الحال حينئذ، يتم تصنيع منتجات شركة "Murano Lab 1291" بشكل يدويّ تماماً وتلقاها وعملها من قبل متخصصين من مورانو مع مصممين من بينهم "Lenarda" و"Rasmussen" اللذين تعاوننا مع شركة "Voltolina" منذ وقت طويل.

"ممكنة أن يكون محاملاً بمنتجات مصنوعة بشكل يدويّ تماماً جنباً إلى جنب مع البحث عن مستوى جودة دائماً أعلى هو من أهداف للخدمة الذي يسمح لعملنا تجربة مشاهير إيجابية داخل المسكن الخاص به" هكذا يقول "Andrea Voltolina" - المدير الأحدث للشركة.

كل هذا بالنسبة لنا يمثل الفخامة، ويأقفل في أوقات الشدة الاقتصادية والركود يزيد الإقبال نحو الفخامة المفهومة بصفتها الارتياح والزخا الشخصي.

داخل شركة "Murano Lab 1291" يُمكن للعميل اختيار لون وأبعاد الثريا الخاصة به مستفيداً من خبرة المتخصصين بمورانو الذين يؤمنون براعتهم التصنيعية على قاعدة فن الزجاج القديمة.

تقوم خدمة ما بعد البيع على فريق من الفنيين بالتركيب الذين يقومون بتركيب الثريا مباشرة في منزل العميل في أي بلد من بلدان العالم.

يُعدّ واحداً من أولى جواهر "Murano Lab 1291" المنتج "Rialto" الذي تم تصنيعه بالتعاون مع التصميم "Alessandro Lenarda".

لما "Brian Rasmussen" فهو صانع لمة "Medusa" التي تُعدّ مزيجاً مثاليّاً بين تقاليد الزجاج القديمة الخاصة بمورانو والتصميم الحديث والمتخصصين.



I vetri di Murano, grazie alle loro lavorazioni particolari di soffiatura a più strati ed eseguiti interamente a mano libera da maestri vetrai sono da ritenersi pezzi unici, che si distinguono completamente dai vetri pressati, centrifugati o colorati, tipici di realtà industriali. Leggere le imprecisioni e differenze nei colori, forme e spessori sono pregi che testimoniano l'assoluta artigianalità e manualità dei prodotti della nostra collezione VENICE.

It's not just beautiful design that makes Murano glass so desirable it's the skill, craftsmanship and techniques perfected over generations, like multi layer blowing techniques which are used to create stunning pieces. This skill, dedication and craftsmanship gives the finished pieces a level of unique beauty that pressed, spin dried and other industrial coloured glass production techniques simply cannot match. The result can be seen in "The Venice Collection" a collection of unique pieces which blend great craftsmanship with subtle colours to capture and play with the magic of light bringing unique beauty to almost any environment.

Les verres de Murano, grâce à leur travail particulier de soufflage en plusieurs couches, et exécutés entièrement à main levée par les maîtres vitriers, sont pièces uniques, que se distinguent des verres pressés, essorés ou colorés typiquement industriels. Les petites imperfections et les différences de couleur, formes et épaisseurs sont qualités que témoignent l'artisanalité et l'habileté manuelle des produits de notre collection Venice.

El vidrio de Murano, gracias a su particular elaboración artesanal con soplado y trabajo íntegramente manual realizado por los maestros vidrieros, da lugar a la creación de piezas únicas, que se distinguen completamente de los vidrios prensados, centrifugados o pintados, típicos de la producción industrial. Ligeras imperfecciones y diferencias en el color, formas y espesores son muestras que certifican la artesanía y elaboración manual de los productos de nuestras colecciones VENICE.

MURANO

collection news



Medusa	pag 300
I Do	pag 306
Jacaranda	pag 316
Onda	pag 320
Rialto	pag 322
Barena	pag 334
Iris	pag 338
Nuvola	pag 346
Ca' Rezzonico	pag 354



MURANO

collection news 2011



Medusa	pag 300
I Do	pag 306
Jacaranda	pag 316
Onda	pag 320
Rialto	pag 322
Barena	pag 334
Iris	pag 338
Nuvola	pag 346
Ca' Rezzonico	pag 354

MEDUSA

design: Brian Rasmussen



Medusa lampadario Ø 76 cm
Ø 76 cm - H 58 cm
4 x E27 75W



MEDUSA

design: Brian Rasmussen



Medusa lampadario Ø 76 cm
Ø 76 cm - H 58 cm
4 x E27 75W

Medusa lampadario Ø 76 cm
Ø 76 cm - H 58 cm
4 x E27 75W



MEDUSA

design: Brian Rasmussen



Medusa lampadario Ø 76 cm
Ø 76 cm - H 58 cm
4 x E27 75W

MEDUSA

design: Brian Rasmussen

Modello depositato / Registered design / modèle déposé / articolo patentato



La collezione Medusa è una creazione dell'architetto danese Brian Rasmussen e realizzata da Murano Lab 1291. Leggerezza ed eleganza si mescolano in questa collezione dal design moderno e declinato in una elevatissima gamma di colori, in soluzioni bicolori o anche multicolore.

The Medusa collection is designed by Brian Rasmussen, Danish Architect and realised by Murano Lab 1291. Lightness and elegance merge in this contemporary collection which is available in several colours, bicolour or multicolour.

La collection Medusa a été créée par l'architecte danois Brian Rasmussen et réalisé par Murano Lab 1291. Légèreté et élégance se mélangent dans cette collection avec un design moderne et décliné avec une très grande gamme de couleurs, en solutions bi coloris et multi coloris.

La colección Medusa es una creación del arquitecto Danés Brian Rasmussen, producida por Murano Lab 1291. Ligereza y elegancia se mezclan en esta colección de diseño moderno, disponible en una amplísima gama de colores, en combinaciones bicolor y también multicolor.

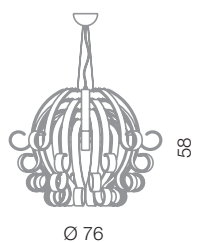

Medusa lampadario Ø 76 cm
Ø 76 cm - H 58 cm
4 x E27 75W



Seta



Bianco



Cristallo



Nero



Acquamarina chiara



Bluino



Rosso



Ambra



Arancio



Lilla



Acciaio



Cristallo / oro

I DO

design: Alessandro Lenarda



I Do lampadario 9L
Ø 73 cm - H 59 cm
9x G9 40W



I DO

design: Alessandro Lenarda



I Do lampadario 6L
Ø 50 cm - H 45 cm
6 x G9 40W

I Do lampadario 6L
Ø 50 cm - H 45 cm
6 x G9 40W



I DO

design: Alessandro Lenarda



I Do lampadario 5L
Ø 28 cm - H 87 cm
5 x G9 40W

I Do lampadario 3L
Ø 28 cm - H 45 cm
3 x G9 40W

I Do lampadario 6L
Ø 28 cm - H 129 cm
6 x G9 40W

I Do lampadario 3L
Ø 28 cm - H 45 cm
3 x G9 40W



I DO

design: Alessandro Lenarda



I Do parete 1L
L 25 cm - H 31 cm - SP 17 cm
1 x G9 40W

I Do parete 2L
L 30 cm - H 59 cm - SP 19 cm
2 x G9 40W



I Do piantana 3L
Ø 30 cm - H 160 cm
3 x G9 40W



I Do tavolo 3L
Ø 28 cm - H 35 cm
3 x G9 40W



I Do tavolo 3L
Ø 28 cm - H 50 cm
3 x G9 40W



I DO

design: Alessandro Lenarda

Modello depositato / Registered design / modèle déposé / articulo patentado



Una matita che corre leggera e sicura sulla carta segnando i limiti di un pensiero. Un progetto che si snoda, evolvendosi, in una composizione mobile. Le mani del vetraio che realizzano con sicurezza, la serie pensata. E la tua creatività per realizzare una struttura di luce, sognando Murano, naturalmente. Con la serie I DO ogni persona ha la possibilità di creare il design della propria lampada, giocando con gli elementi in vetro fatto a mano siano essi monocolori oppure multicolori. In questo modo ogni I DO potrà essere Unico.

A pencil effortlessly gliding over paper, turning thought into reality. A vision comes to life, evolving into an organic composition. The skilled hand of the glass master, materialises the thought. And your creativity too can become real – in a lighting structure, inspired of course by Murano. With the I DO series, every individual has the opportunity to build their very own design, by arranging the hand made components, in either clear or coloured glass. This way, every I DO can be unique.

Un crayon qui cour sur le papier, léger et déterminé, marquant les limites d'une pensée, un projet qui se dénoue, en évoluant en une composition mobile. Les mains du verrier qui réalisent avec assurance, la série pensée. C'est ta créativité pour réaliser une structure de lumière, en rêvant Murano, naturellement. Avec la série I DO, chaque personne a la possibilité de créer le dessin de sa propre lampe, en jouant avec les éléments en verre fait à la main, que ceux-ci soient d'une seule couleur ou multicolores. De cette manière chaque I DO pourra être unique.

Un lápiz que corre ligero y seguro sobre el papel marcando los límites de un pensamiento. Un proyecto que se ejecuta, volviéndose, una composición móvil. Las manos del maestro vidriero que realizan con seguridad, la serie pensada. Y tu creatividad para realizar una estructura de luz, soñando Murano, naturalmente. Con la serie I DO cada persona tiene la posibilidad de crear el diseño de su propia lámpara, jugando con los elementos de vidrio hechos a mano sean monocolor o multicolor. De este modo cada I DO podrá ser Unico.

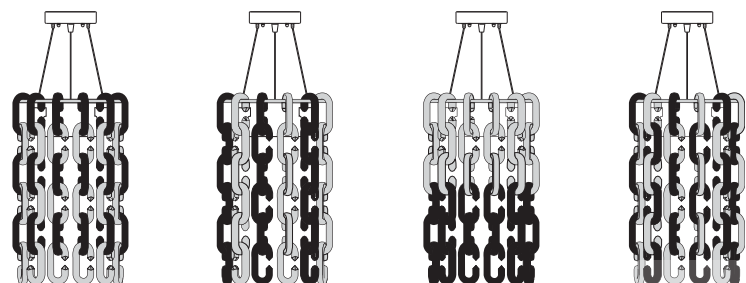

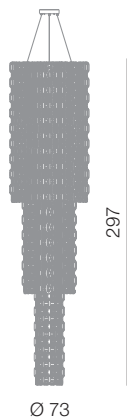

I Do lampadario 18L
 Ø 73 cm - H 297 cm
 18 x G9 40W

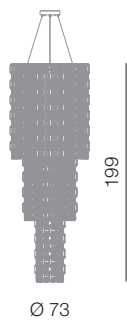

I Do lampadario 12L
 Ø 73 cm - H 199 cm
 12 x G9 40W

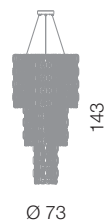

I Do lampadario 9L
 Ø 73 cm - H 143 cm
 9 x G9 40W



I Do lampadario 8L
 Ø 73 cm - H 59 cm
 8 x G9 40W

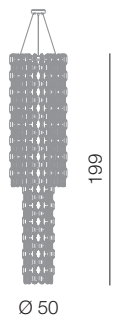

I Do lampadario 9L
 Ø 50 cm - H 199 cm
 9 x G9 40W

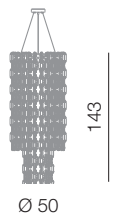

I Do lampadario 7L
 Ø 50 cm - H 143 cm
 7 x G9 40W



I Do lampadario 6L
 Ø 50 cm - H 45 cm
 6 x G9 40W

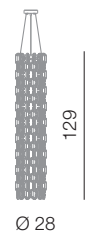

I Do lampadario 6L
 Ø 28 cm - H 129 cm
 6 x G9 40W

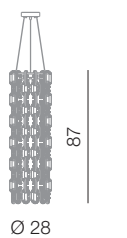

I Do lampadario 5L
 Ø 28 cm - H 87 cm
 5 x G9 40W

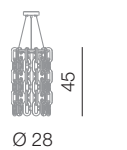

I Do lampadario 3L
 Ø 28 cm - H 45 cm
 3 x G9 40W

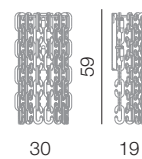

I Do parete 2L
 L 30 cm - H 59 cm - SP 19 cm
 2 x G9 40W

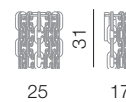

I Do parete 1L
 L 25 cm - H 31 cm - SP 17 cm
 1 x G9 40W

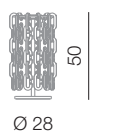

I Do tavolo 3L
 Ø 28 cm - H 50 cm
 3 x G9 40W

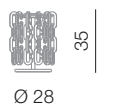

I Do tavolo 3L
 Ø 28 cm - H 35 cm
 3 x G9 40W

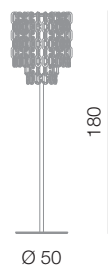

I Do piantana 6L
 Ø 50 cm - H 180 cm
 6 x G9 40W

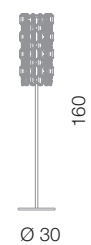

I Do piantana 3L
 Ø 30 cm - H 160 cm
 3 x G9 40W

JACARANDA



Jacaranda sospensione 1L
Ø 10 cm - H 15 cm
1 x E14 60W



JACARANDA



Jacaranda lampadario **TRIO**
Ø 30 cm - H 180 cm
3 x E14 60W

JACARANDA

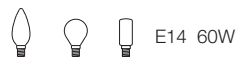

Sospensioni con diffusore in vetro di Murano lavorato a mano, disponibili in vari colori, particolari in metallo con finitura nichel.

Hanging lamps with hand-made blown Murano glass, available with a wide range of colours; nickel metal frame.

Suspensions en verre de Murano travaillé à la main, disponibles en plusieurs couleurs et finition nickelée.

Suspensión de cristal de Murano soplado a mano, disponible en varios colores, con acabado níquel.



Jacaranda lampadario 1L
Ø 10 cm - H 15 cm
1 x E14 60W

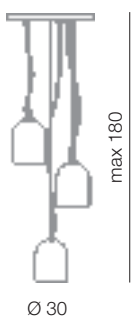

Jacaranda lampadario **TRIO**
Ø 30 cm - H 180 cm
3 x E14 60W



River Pervinca



River Rosso



River Giallo



River Pistacchio



Candy



Bamboo



Quadri



Meg B&W



Meg Rosso



Meg Arancio



Meg Azzurro



Meg Bianco



Eleganza



Greca

ONDA



Onda lampadario 1L
Ø 16 cm - H 22 cm
1 x E14 60W

ONDA



Sospensioni con diffusore in vetro soffiato e lavorato a mano disponibile nei colori ametista, blu, verde e giallo/rosso. Montatura in metallo con finitura cromata.

Hanging lamps in handmade blown glass available in amethyst, blue, green, and yellow/red colours. Chrome metal frame.

Suspensions avec diffuseur en verre soufflé et travaillé à la main, disponibles dans les couleurs: améthyste, bleu, vert et jaune/rouge. Monture en métal, finition chromée.

Colgantes con tulipas de vidrio soplado y elaborado a mano, disponibles con los siguientes colores: amatista, azul, verde y amarillo/rojo. Estructura de metal con acabado en cromo.

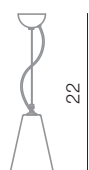

Ø 16

Onda lampadario 1L
Ø 16 cm - H 22 cm
1 x E14 60W



Ametista



Giallo / rosso



Verde

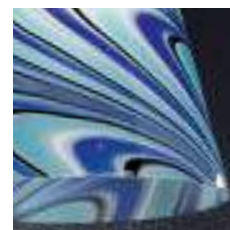

Blu

RIALTO

design: Alessandro Lenarda



Rialto lampadario 12L
Ø 92 cm - H 110 cm
12 x E14 40W

Rialto lampadario 12L
Ø 92 cm - H 110 cm
12 x E14 40W



RIALTO

design: Alessandro Lenarda



Rialto lampadario 12L
Ø 92 cm - H 110 cm
12 x E14 40W



RIALTO

design: Alessandro Lenarda



Rialto lampadario 8L
Ø 79 cm - H 89 cm
8 x E14 40W

Rialto lampadario 8L
Ø 79 cm - H 89 cm
8 x E14 40W



RIALTO

design: Alessandro Lenarda



Rialto lampadario 6L
Ø 78 cm - H 86 cm
6 x E14 40W

Rialto lampadario 6L
Ø 78 cm - H 86 cm
6 x E14 40W



RIALTO

design: Alessandro Lenarda



Rialto parete 3L
L 50 cm - H 54 cm - SP 33 cm
3 x E14 40W

Rialto lampadario 5L
Ø 77 cm - H 86 cm
5 x E14 40W



RIALTO

design: Alessandro Lenarda



Rialto parete 2L
L 39 cm - H 54 cm - SP 27 cm
2 x E14 40W

Rialto tavolo 1L
Ø 20 cm - H 32 cm
1 x E14 40W

RIALTO

design: Alessandro Lenarda



Collezione di lampadari prodotti a Murano in stile contemporaneo, disegnati dall'Arch. Alessandro Lenarda. Disponibili nelle colorazioni nero, rosso, bianco, viola, cristallo, cristallo/oro, ambra e blu.

Lamp collection made in Murano in a contemporary style designed by the Architect Alessandro Lenarda. Available in black, red, white, violet, crystal, crystal/gold, amber and blue colours.

Luminaire produits à Murano de style Contemporain, développés par Arch. Alessandro Lenarda. Disponibles en cristal/or, cristal, noir, rouge, blanc, violet, ambre, blu.

Colección de lámparas de Murano producido en un estilo contemporáneo, diseñado por el arquitecto Alessandro Lenarda. Disponible en negro, rojo, blanco, cristal violeta, el cristal/oro, ambar y azul.

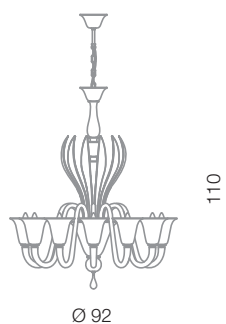

Rialto lampadario 12L
Ø 92 cm - H 110 cm
12 x E14 40W

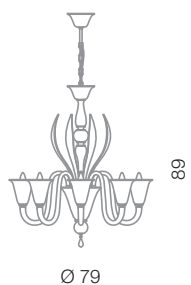

Rialto lampadario 8L
Ø 79 cm - H 89 cm
8 x E14 40W



Rialto lampadario 6L
Ø 78 cm - H 86 cm
6 x E14 40W

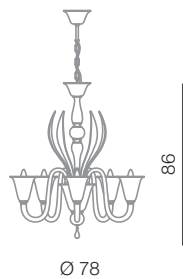

Rialto lampadario 5L
Ø 77 cm - H 86 cm
5 x E14 40W

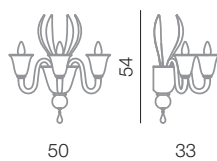

Rialto parete 3L
L 50 cm - H 54 cm - SP 33 cm
3 x E14 40W

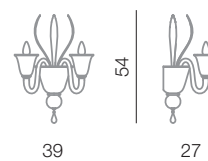

Rialto parete 2L
L 39 cm - H 54 cm - SP 27 cm
2 x E14 40W

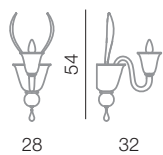

Rialto parete 1L
L 28 cm - H 54 cm - SP 32 cm
1 x E14 40W

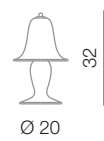

Rialto tavolo 1L
Ø 20 cm - H 32 cm
1 x E14 40W

BARENA



Barena lampadario 12L
Ø 116 cm - H 90 cm
12 x E14 40W

Barena lampadario 5L
Ø 72 cm - H 72 cm
5 x E14 40W



BARENA



Barena parete 2L
L 51 cm - H 26 cm - SP 30 cm
2 x E14 40W

BARENA

Modello depositato / Registered design / modèle déposé / artículo patentado



Collezione di lampadari prodotti a Murano in stile contemporaneo. Disponibili nelle colorazioni nero, rosso, bianco, viola, cristallo, cristallo/oro e ambra.

Lamp collection made in Murano in a contemporary style. Available in black, red, white, violet, crystal crystal/gold and amber colours.

Luminaire produits à Murano de style Contemporain. Disponibles en cristal/or, cristal, noir, rouge, blanc, violet, ambre.

Colección de lámparas de Murano producido en un estilo contemporáneo. Disponible en negro, rojo, blanco, cristal violeta, el cristal/oro y ambar.

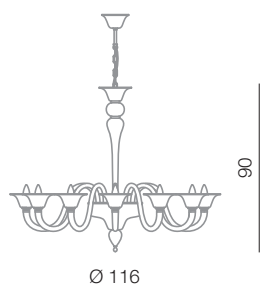

Barena lampadario 12L
Ø 116 cm - H 90 cm
12 x E14 40W

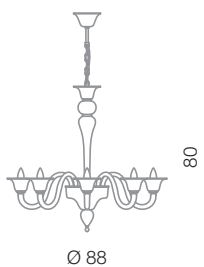

Barena lampadario 8L
Ø 88 cm - H 80 cm
8 x E14 40W

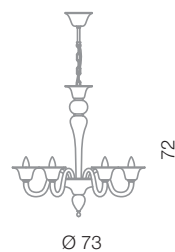

Barena lampadario 6L
Ø 73 cm - H 72 cm
6 x E14 40W

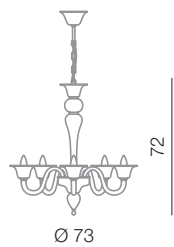

Barena lampadario 5L
Ø 73 cm - H 72 cm
5 x E14 40W



Barena parete 3L
L 63 cm - H 27 cm - SP 38 cm
2 x E14 40W



Barena parete 2L
L 51 cm - H 26 cm - SP 30 cm
2 x E14 40W



Barena parete 2L
L 51 cm - H 26 cm - SP 30 cm
2 x E14 40W

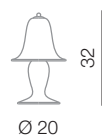

Barena tavolo 1L
Ø 20 cm - H 32 cm
1 x E14 40W

IRIS



Iris lampadario 8L
Ø 102 cm - H 88 cm
8 x E14 40W

Iris lampadario 12L
Ø 110 cm - H 90 cm
12 x E14 40W



IRIS



Iris lampadario 6L
Ø 75 cm - H 80 cm
6 x E14 40W

Iris lampadario 5L
Ø 75 cm - H 80 cm
5 x E14 40W



IRIS



Iris lampadario 6L
Ø 75 cm - H 80 cm
6 x E14 40W

Iris lampadario 6L
Ø 75 cm - H 80 cm
6 x E14 40W



IRIS



Iris parete 2L
L 51 cm - H 55 cm - SP 31 cm
2 x E14 40W

IRIS



Disegnata dallo studio tecnico Voltolina e sviluppata e prodotta da Murano Lab 1291, la collezione Iris è disponibile in una vasta gamma colori e completata da una lavorazione a filo sulle bordure dei suoi componenti. Iris è disponibile nelle varianti 5, 6, 8, 12 luci e applique 2 luci.

Designed by Voltolina Technical dept and produced by Murano Lab 1291. The Iris collection is available in a wide range of colours and every chandelier is adorned with coloured rims made by using a particular working technique. Iris is available in 5, 6, 8 or 12 lights and 2 lights wall lamp.

Dessinée par le Cabinet Technique Voltolina, développé et produite par Murano Lab 1291, la collection Iris est disponible avec plusieurs couleurs et complété par un travail à fil des bordures de ses composants. Iris est disponible à 5, 6, 8 et 12 lampes et applique à 2 lampes.

Diseñada por el estudio técnico Voltolina, desarrollada y manufacturada por Murano Lab 1291, la colección Iris está disponible en una vasta gama de colores, completada por una elaboración artesanal a hilo sobre los bordes de sus componentes. Iris está disponible en 5, 6, 8 y 12 luces y en apliques de 2 luces.

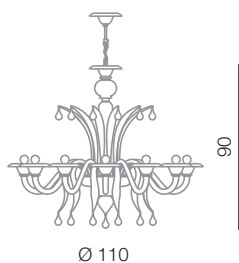

Iris lampadario 12L
Ø 110 cm - H 90 cm
12 x E14 40W

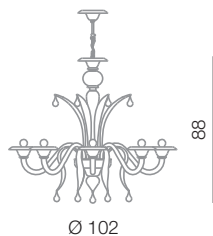

Iris lampadario 8L
Ø 102 cm - H 88 cm
8 x E14 40W



Iris lampadario 6L
Ø 75 cm - H 80 cm
6 x E14 40W

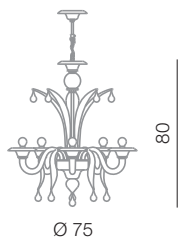

Iris lampadario 5L
Ø 75 cm - H 80 cm
5 x E14 40W

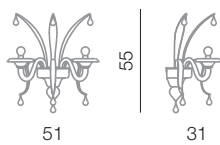

Iris parete 2L
L 51 cm - H 55 cm - SP 31 cm
2 x E14 40W

NUVOLA



Nuvola lampadario 12L
Ø 122 cm - H 103 cm
12 x E14 40W

Nuvola lampadario 8L
Ø 108 cm - H 96 cm
8 x E14 40W



NUVOLA



Nuvola lampadario 6L
Ø 78 cm - H 83,5 cm
6 x E14 40W

Nuvola lampadario 6L
Ø 78 cm - H 83,5 cm
6 x E14 40W



NUVOLA



Nuvola lampadario 12L
Ø 122 cm - H 103 cm
12 x E14 40W



NUVOLA



Nuvola parete 2L
L 50 cm - H 53 cm - SP 30 cm
2 x E14 40W

NUVOLA



Collezione di lampade prodotte a Murano in vetro soffiato, disegnate dallo Studio Tecnico Voltolina. Disponibili nei colori bianco, nero con pendenti oro, viola incamiciato o arancione incamiciato, ambr e cristallo. Le coppe hanno la particolarità di essere lavorate con metodo Ballotton che conferisce un disegno a losanghe sulla superficie.

Lamp collection in blown glass, made in Murano and designed by Voltolina Technical Dept. Available colours: white, black with gold leaf trimmings, cladding violet or orange, amber and crystal. Cups are worked with the "ballotton" manufacturing which gives the surface a lozenge design.

Luminaires produits à Murano, en verre soufflé et travaillé à la main, développé par le Cabinet Technique Voltolina. Disponibles en blanc, noir avec détails dorés, violet chemisé et orange chemisé, ambré, cristal. Les tasses sont travaillées avec la méthode Ballotton que donne un dessin à losanges sur la surface.

Colección de lámparas producidas en Murano en vidrio soplado, diseñadas por el Estudio Técnico Voltolina. Disponibles en los colores, blanco, negro con colgantes oro, violeta o naranja, ambar y cristal. Las tulipas tienen la particularidad de ser elaboradas con el método "Ballotton" que le confiere un diseño a rombos en la superficie.

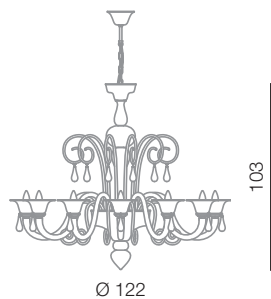

Nuvola lampadario 12L
Ø 122 cm - H 103 cm
12 x E14 40W

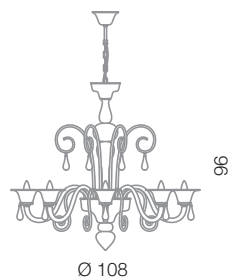

Nuvola lampadario 8L
Ø 108 cm - H 96 cm
8 x E14 40W



Nuvola lampadario 6L
Ø 78 cm - H 83,5 cm
6 x E14 40W

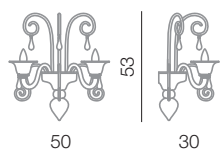

Nuvola parete 2L
L 50 cm - H 53 cm - SP 30 cm
2 x E14 40W

CA' REZZONICO



Ca' Rezzonico lampadario 9L
Ø 103 cm - H 135 cm
9 x E14 40W



CA' REZZONICO



Ca' Rezzonico lampadario 6L
Ø 82 cm - H 108 cm
6 x E14 40W

Ca' Rezzonico lampadario 6L
Ø 82 cm - H 108 cm
6 x E14 40W



CA' REZZONICO



Ca' Rezzonico parete 3L
L 70 cm - H 27 cm - SP 41 cm
3 x E14 40W



Ca' Rezzonico parete 2L
L 51 cm - H 47 cm - SP 29 cm
2 x E14 40W

CA' REZZONICO



Lampadari in stile Rezzonico prodotti a Murano e disponibili nelle colorazioni a richiesta del cliente. Cristallo, cristallo/oro e cristallo policromo sono i colori più richiesti.

Lamp collection in "Rezzonico" style made in Murano and available in different colours according to client's request. Crystal, crystal/gold, polychrome crystal are the most requested colours.

Luminaire de style Rezzonico, produits à Murano et disponibles en couleurs selon la choix du client. Les plus demandées sont cristal, cristal/or, cristal polychrome.

Lámparas estilo "Rezzonico" producidas en Murano y disponibles en diversos colores según requiera el cliente. Cristal, cristal/oro y cristal policromo son los colores más solicitados.

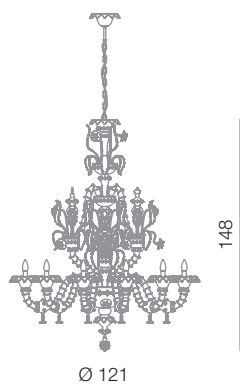

Ca' Rezzonico lampadario 12L
Ø 121 cm - H 148 cm
12 x E14 40W

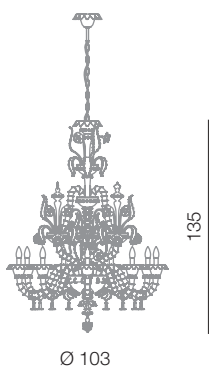

Ca' Rezzonico lampadario 9L
Ø 103 cm - H 135 cm
9 x E14 40W



Ca' Rezzonico lampadario 6L
Ø 82 cm - H 108 cm
6 x E14 40W

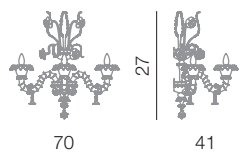

Ca' Rezzonico parete 3L
L 70 cm - H 27 cm - SP 41 cm
3 x E14 40W

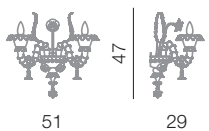

Ca' Rezzonico parete 2L
L 51 cm - H 47 cm - SP 29 cm
2 x E14 40W



ALESSANDRO LENARDA

designer

Alessandro Lenarda, veneziano, nasce il 1 giugno 1939. Dopo studi classici e musicali, si laurea in architettura a Venezia. Si dedica quasi esclusivamente al design con particolare riguardo al vetro, ai mobili, all'illuminazione, all'arredo bagno e all'arredo urbano. Dal 1976 è Accademico Associato dell'Accademia Tiberina di Roma. E' socio ADI (Associazione per il Disegno Industriale) e BEDA (Bureaux of European Designers Associations). Ha esposto alla Biennale Internazionale d'Arte di Venezia nelle edizioni 1964, 1966, 1970, 1972 e alla Biennale del Centenario del 1995. Ha avuto due Selezioni e una Segnalazione d'Onore al premio "Compasso d'Oro". Alcune sue opere fanno parte del patrimonio artistico di musei in Venezia, Altare, Milano, Monaco di Baviera, Pirano, Londra, New York. Le sue opere sono state oggetto di Tesi di Laurea – Roma – Università La Sapienza e della monografia "Alessandro Lenarda a Murano" edita da Antonio Zoppas. Alcune sue opere sono state dichiarate "di eccezionale interesse artistico e storico" e inserite nel "Patrimonio Culturale della Nazione". Dal 1994 vive e lavora in Blera – Viterbo.

Alessandro Lenarda was born in Venice on 01 June 1939. After classical and musical studies, he graduated in Architecture in Venice. He deals almost exclusively with design in particular of glass, furniture, lighting, bathroom and street furnishings. Since 1976 he has been Member of Academy Tiberina in Rome. He is member ADI (Association for the Industrial Design) and BEDA (Bureaux of European Designers Associations). He exhibited at International Exhibition Biennale in Venice in 1964, 1966, 1970, 1972 and at the Centenary Biennale in 1995. He was awarded a prize at "Compasso d'Oro" Award. Some of his works will be part of the artistic heritage of museums in Venice, Altare, Milan, Munich, Pirano, London, New York. His works have been a subject of a Thesis of Università La Sapienza in Rome and of an essay "Alessandro Lenarda in Murano" published by Antonio Zoppas. Some of his works have been considered "of extraordinary artistic and historical interest" and included in the "Cultural Heritage of the Nation". Since 1994 he has lived and worked in Blera – Viterbo.

Alessandro Lenarda, vénitien, est né le 1er juin 1939. Il passe sa licence de architecture à Venise après avoir terminé des études classiques. Il s'occupe surtout du design, avec particulier intérêt pour le verre, l'ameublement, l'éclairage, la décoration des salles de bains et la décoration urbaine. A partir du 1976 il est un associé de l'Accademia Tiberina à Rome. Il est aussi associé ADI (Association pour le Dessin Industriel) et BEDA (Bureaux of European Designers Associations). Il a été au Biennale Internazionale d'Arte de Venise en les années 1964, 1966, 1970, 1972 et il a été au Biennale del Centenario du 1995. Il a obtenu deux Sélections et une signalisation d'honneur au prix "Compasso d'Oro". Certains travaux appartiennent au patrimoine artistique des musées de Venise, Altare, Milan, Munich, Pirano, Londrès, New York. Ses travaux ont été objet de thèses du diplôme d'études supérieures de l'Università la Sapienza en Rome et de la monographie « Alessandro Lenarda a Murano » par les soins de Antonio Zoppas. Quelques-uns de ses travaux est déclaré « d'exceptionnel intérêt historique et artistique » et ajouté au « Patrimoine Cultural du Pays ». A partir du 1994 il vit et il travaille à Blera (Viterbo).

Alessandro Lenarda, Veneziano, nace el 1 de Junio de 1939. Después de estudios clásicos y musicales, se gradúa en arquitectura en Venezia. Se dedica casi exclusivamente al diseño con atención especial por el vidrio, mobiliario, iluminación, muebles de baño y mobiliario urbano. Desde el 1976 es Académico Asociado de la Academia Tiberina de Roma. Es socio ADI ("Associazione per il Disegno Industriale") y BEDA ("Bureaux of European Designers Associations"). Ha expuesto en la "Biennale Internazionale d'Arte di Venezia" en las ediciones de 1964, 1966, 1970, 1972 y en la "Biennale del Centenario" del 1995. Ha obtenido dos Selecciones y una mención de honor al premio "Compasso d'Oro". Algunas de sus obras forman parte del patrimonio artístico de los museos de Venezia, Altare, Milano, Munich, Pirano, Londres, New York. Sus obras han sido objeto de tesis de graduación – Roma – "Università La Sapienza" y la monografía "Alessandro Lenarda a Murano" editada por Antonio Zoppas. Algunas de sus obras han estado declaradas "de excepcional interés artístico e histórico" e inseridas en el "Patrimonio Cultural de la Nación". Desde 1994 vive y trabaja en Blera – Viterbo

BRIAN RASMUSSEN

designer



Brian Rasmussen è nato a Ringsted (Danimarca) nel 1973. Si laurea alla "Royal Academy of Architecture" di Copenhagen nel 2000. Già nel primo anno di studio vince il concorso nazionale "PRISOPGAVE KØBENHAVN" (Danimarca) con il progetto futuristico di una stazione della metropolitana. Dopo gli studi si è trasferito a Venezia dove vive attualmente. Nel 2002 vince il secondo premio del concorso nazionale "CRISTIANO D. IV'S BRYGHUS" e decide di aprire il suo studio d'architettura e design a Venezia. Nel 2003 inizia il progetto di ricerca: "Il punto di unione fra barocco romano e classicismo nordico". Questo progetto si trasforma nel fondamento teorico e morfologico per molti dei successivi progetti di Brian. Nel 2004 vince il concorso internazionale d'arte "TARGETTI LIGHT ART AWARD" che si trasforma in un punto di partenza per la sua carriera come progettista d'illuminazione. Nel periodo tra il 2004 ed il 2006 progetta e sviluppa un lampione per la città di Ringsted, Danimarca, in collaborazione con Louis Poulsen Lighting. Nel 2006 vince un concorso di design con due nuovi progetti per l'azienda EviStyle. Brian Rasmussen collabora attualmente con ditte quali Voltolina, Targetti Sankey, Louis Poulsen Lighting, EviStyle e Karboxx.

Brian Rasmussen was born in Ringsted (Denmark) in 1973. He graduates at The Royal Academy of Architecture in Copenhagen in 2000. All ready as a first year student his wins the national student competition " PRISOPGAVE KØBENHAVN"(Denmark) with a project for a futuristic metro station. After his studies he moved to Venice and has been living there ever since. In 2002 he wins the second price in the national architecture competition " CHRISTIAN D. IV'S BRYGHUS" and decides to open his own office of architecture and design in Venice, Italy. In 2003 he starts e research project "the meeting point between the roman baroque and the nordic classicism". This project becomes the theoretic and morphological foundation for many of the later design projects of Brian. In 2004 he wins the international art competition TARGETTI LIGHT ART AWARD which becomes a starting point for his career as lighting designer. From 2004-2006 he designs and develops a streetlamp for the city Ringsted, Denmark in collaboration with Louis Poulsen Lighting. In 2006 he wins a design competition concerning the design of 2 new projects for the firm EviStyle. Brian Rasmussen is now working with firms such as Voltolina, Targetti Sankey, Louis Poulsen Lighting, EviStyle and Karboxx.

Brian RASMUSSEN est né en 1973 à Ringstad, au Danemark. En l'année 2000 il passe sa licence à l'Académie Royale d'Architecture de Copenhague. Déjà, dans sa première année d'étude, il remporte le concours national "PRISOPGAVE KOBENHAVN" (Danemark) avec le projet futuriste d'une station de métro. Après les études, il s'établit à Venise, où il vit actuellement. En 2002 il remporte le second prix au concours national "CIRSTIANO D. IV'S BRYGHUS" et décide d'ouvrir son cabinet d'architecture et de design à Venise. En 2003 il commence son projet de recherche "Le point d'union entre le baroque romain et le classicisme du Nord". Ce projet se transforme en base théorétique et morphologique pour beaucoup de projets successifs de Brian. En 2004 il remporte le concours national d'art "TARGETTI LIGHT ART AWARD" qui se transforme en point de départ pour sa carrière de concepteur lumière. Dans la période entre 2004 et 2006 il conçoit et développe un réverbère pour la ville de Ringsted au Danemark, en collaboration avec Louis Poulsen Lighting. En 2006 in remporte un concours de Design avec deux nouveaux projets pour la société EviStyle. Brian Rasmussen collabore actuellement avec des sociétés telles que Voltolina, Targetti Sankey, Louis Poulsen Lighting, EviStyle et Karboxx.

Brian Rasmussen nace en Ringsted (Dinamarca) el 1973. Se gradúa en la "Royal Academy of Architecture" de Copenhague el 2000. Ya en el primer año de estudio gana el concurso nacional "PRISOPGAVE KØBENHAVN" (Dinamarca) con el proyecto futurístico de una estación de metro. Después de sus estudios se traslada a Venezia donde vive actualmente. El año 2002 logra el segundo premio del concurso nacional "CRISTIANO D. IV'S BRYGHUS" y decide abrir su propio estudio de arquitectura y diseño en Venezia. El 2003 empieza el proyecto de investigación: "El punto de unión entre el barroco y el clasicismo nórdico". Este proyecto se transforma en el fundamento teórico y morfológico para muchos de los sucesivos proyectos de Brian. El 2004 vence el concurso internacional de arte "TARGETTI LIGHT ART AWARD" que se transforma en un punto de partida para su carrera como proyectista de iluminación. En el período entre el 2004 y el 2006 proyecta y desarrolla una gran lámpara para la ciudad de Ringsted, Dinamarca, en colaboración con Louis Poulsen Lighting. El 2006 gana un concurso de diseño con dos nuevos proyectos para la marca EviStyle. Brian Rasmussen colabora actualmente con firmas cómo Voltolina, Targetti Sankey, Louis Poulsen Lighting, EviStyle y Karboxx .



PAOLO CREPAX

designer

Paolo Crepax è un designer ma anche maestro del Vetro di Murano, conosciuto a livello internazionale.

Ha iniziato ad imparare l'antica arte del Vetro di Murano sin da bambino, iniziando l'apprendistato a 10 anni. Continua a dedicarsi a questo tipo di professione con un'immensa passione, che unita alle grandi capacità gli hanno permesso di ottenere diversi premi, tra i quali il primo premio della "Fondazione Bevilacqua", "La Masa" ed il "Primo Premio Murano".

Attualmente si occupa di sviluppare nuove linee di illuminazione ed oggettistica collaborando con Voltolina e Murano Lab 1291.

Paolo Crepax is a world-famous designer and also a Murano Glass Master. He learned the ancient art of Murano glass when he was ten years old and since then he has devoted himself to this profession with an immense passion which, thanks to his great ability, made him receive several prizes, among them the first prize of the "Fondazione Bevilacqua", "La Masa" and "Primo Premio Murano".

He is currently working on developing new ranges of lighting, gift ranges and collaborating with Voltolina and Murano Lab 1291.

Paolo Crepax est un designer, mais également maître du verre de Murano, connu au niveau international.

Il a commencé dès l'enfance, à l'âge de 10 ans, à exercer l'ancien métier du verre de Murano.

Il a continué ce type de profession avec une très grande passion et de grandes capacités, qui ont lui permis d'obtenir plusieurs prix, comme le premier prix de la "Fondazione Bevilacqua", "La Masa" et le "Primo Premio Murano". En ce moment il s'occupe de développer des nouvelles lignes d'illumination et d'objets en collaboration avec Voltolina et Murano Lab 1291.

Paolo Crepax es un famoso diseñador reconocido mundialmente y experto en el vidrio de Murano.

Aprendió la antigua técnica del manejo del Murano cuando tan sólo tenía diez años y desde entonces la ha hecho suya, haciendo de este arte su profesión, con su insuperable pasión y gracias a su gran habilidad, ha sido reconocido con numerosos premios como el primer premio de la "Fondazione Bevilacqua", "La Masa" y "Primo Premio Murano".

Actualmente está trabajando en el desarrollo del campo de la iluminación y regalos y colaborando con Voltolina y Murano Lab 1291.



Underwriters
Laboratories
Marchio di conformità U.S.A.
American quality institute



La marcatura CE attesta che le lampade rispondono
ai requisiti delle norme europee EN 60 598-1
Fixtures according EN 60 598-1



IMQ - Marchio di Conformità italiano
IMQ - Italian Quality Institute



Montaggio diretto su superfici infiammabili
Direct mounting on normally flammable surfaces



Lampade ad incandescenza E14
Incandescent lamps



Lampade ad incandescenza E27
Incandescent lamps



Lampada alogena E14
Halogen lamp



Lampada alogena E27
Halogen lamp



Lampada alogena G9
Halogen lamp



Lampada fluorescente E27
Fluorescent lamp

Questa pubblicazione o parte di essa
non può essere riprodotta in nessun caso senza
l'autorizzazione scritta di Voltolina.
Voltolina si riserva il diritto di apportare
qualsiasi modifica ritenesse opportuna,
senza alcun preavviso.

No parts of this publication may be
reproduced by any means without prior
written authorization from Voltolina.
Voltolina reserves the right to introduce
any changes to its own models,
without notice in advance.

COLLEZIONE FARNESINA DESIGN

design: Alessandro Lenarda



REFERENZE



1. La Residence (ABANO TERME) - 2. Ballando con le stelle (RAI) - 3. Debora Sinibaldi (MILANO) - 4. Showroom Abitare il Tempo (VERONA) - 5. Relais Villa Fiorita (MONASTIER di TREVISO) - 6. Discoteca Piranha (VILLA PESARO) - 7. Moschea Casbah Amin (CASABLANCA) - 8. Escada (FRANCOFORTE) - 9. Gioielleria Kara's (CASABLANCA) - 10. Prefettura (CASABLANCA)



11. Notti sul ghiaccio (RAI) - 12. Escada (TAIPEI) - 13. Le Coupole Glass (VENEZIA) - 14. La Residence (ABANO TERME) - 15. Sfilata di moda Shima Seiki Kansai (GIAPPONE) - 16. Hotel Al Kandar (CASABLANCA) - 17. Escada (FRANCOFORTE) - 18. Hillgrove (IRLANDA) - 19. B-Chic (JESOLO)

Concept / Art Direction / Graphic Design
DITRE GROUP
www.ditre.com

Photo:
QUASAR
www.quasarfoto.com

Paolo Belvedere
PP 128-129, 153, 243, 254*255, 289, 290-291, 296,
297, 298-299

Forma3 Road
PP 102, 103, 104, 109, 110, 144, 145, 146, 147, 202,
203, 204, 314, 322, 327, 328, 330, 331, 346, 347, 348,
352, 354, 355, 356, 357, 358

B.S. Studio
PP 9

Pointer
PP 340, 342, 343

Antonio Braga
PP 10, 12-13

Printing
DITRE ARTI GRAFICHE



VOLTOLINA

VENEZIA

tel. +39 041 907666
fax +39 041 907130
www.voltolina.com



MURANO

member of



Consorzio Veneto dei
Sistemi per l'illuminazione
www.luceinveneto.it



