





Edizione 2017

100% MADE IN ITALY

Il Dettaglio, lo Stile, la Qualità Artigianale.

Artisan Quality,
Style and Care to Detail.

SOLUZIONI SYLCOM nasce per dare una risposta alla richiesta di prodotti artigianali di qualità. Ogni pezzo della collezione viene realizzato singolarmente, frutto di una profonda conoscenza della tradizione veneziana nella lavorazione del vetro. Alla base di tutto, il concetto di bellezza che illumina il quotidiano. L'intero processo di produzione avviene all'interno dell'azienda, luogo in cui viene posta grande attenzione al singolo dettaglio e da dove ogni elemento di luce viene immesso nel mercato con la certificazione 100% Made in Italy.

SOLUZIONI SYLCOM was created to respond to the demand for quality artisan-made products. Every piece belonging to the collection is created individually, the result of an in-depth knowledge of Venetian glass-making traditions. Everything is backed by a concept of beauty that illuminates the everyday. The entire production process is carried out inside the company where extreme care is given to the minimum detail. And from where every lighting element is placed on the market with the "100% Made in Italy" certification.

Costruisci la tua dimensione di luce unica.

Create your exclusive
lighting dimension.

SOLUZIONI SYLCOM è pensato per portare nei contesti attuali la storia di un'arte millenaria basata su di una complessa manualità: il risultato è un prodotto moderno e raffinato, elegante nelle forme e capace di regalare un tocco di stile nell'ambiente in cui si inserisce. I prodotti sono pensati per essere installati anche in gruppi di luce, lasciando così all'interior designer la possibilità di giocare con la modularità degli elementi grazie all'elevato grado di customizzazione delle composizioni.

SOLUZIONI SYLCOM was created to enhance the interiors of modern-day buildings through the art of exquisite manual skills, which boasts a history of over a thousand years. The result: a modern, highly refined product that conveys quality and class at first glance, in any environment. The products were also designed to be installed in groups of light, thus allowing interior designers to work on modularity in order to achieve highly customized, unique compositions.

Index



APHROS 40



BITTA 52



CAN CAN 166



KORINTHOS 142



MASK 102



PHOENIX 194



CASA BLANCA 62



CHAOTIC 74



DIVA 120



SPHERA 130



STREET 180



SWEET 8



EMISPHERA 88



IGLOO 18



JUPITER 30



TRON 156



SWEET

Design
Andrea Lazzari







SWEET

Misure in cm / Measures in cm

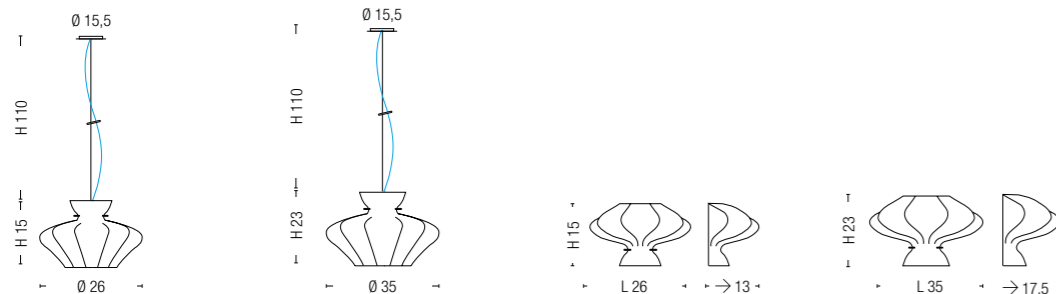

- 0140**
 1 x max 42W E14
- 0141**
 1 x max 70W E27
- 0144**
 2 x max 40W G9
- 0145**
 2 x max 42W E14

SISTEMA PER COMPOSIZIONI MULTIPLE / MULTIPLE ARRANGEMENTS / SYSTEME POUR COMPOSITIONS MULTIPLES / SYSTEM VON VIELFACH ANORDNUNGEN / SISTEMA PARA MULTIPLES COMPOSICIONES / СИСТЕМА ДЛЯ КОМПОЗИЦИИ НА НЕСКОЛЬКО ПОДВЕСНЫХ ЭЛЕМЕНТОВ

Fornito senza rosone
 - Supplied without ceiling rose -

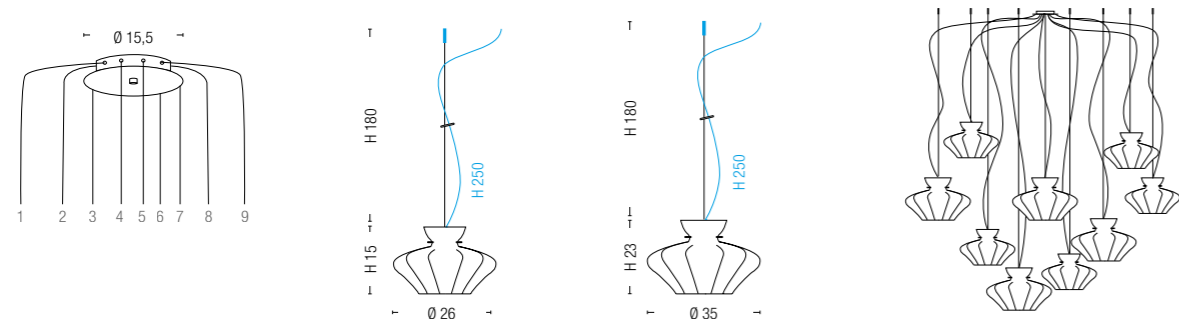

***KIT 0142** + **0142** + **0143** = **KIT 0142 + (n°) 0142 + (n°) 0143**

1 x max 42 W E14 1 x max 70W E27

*Rosone in cromo per composizioni multiple: comunicare il nr. di uscite da inserire nel KIT (rosone). Massimo 9 uscite. / Chrome ceiling rose for multiple arrangements: please indicate the nr. of exits to be inserted in the KIT (ceiling rose). Carries maximum 9 exits. / Pavillon en chrome pour compositions multiples: svp communiquer le nombre de sorties à insérer dans le KIT (pavillon). Maxi 9 sorties. / Chrom Fensterrose fuer vielfache Anordnungen: bitte mitteilen Sie die Anzahl von Elemente, sie brauchen. Hoechstnummer: 9 Elemente. / Para realizar la composición multiple se necesita comunicar el numero de elementos para colocar en el KIT (florón). El numero maximo que se pueden colocar es de 9 elementos. / Хромированное потолочное основание на несколько подвесных светильников. Максимум 9 элементов. Для создания правильной композиции с одним потолочным основанием (KIT) на несколько подвесных элементов при заказе необходимо указывать их количество.

FINITURA METALLO / METAL FINISHES / FINITIONS MÉTAL / METALL-FINISH / ACABADOS EN METAL / ОТДЕЛКА МЕТАЛЛОМ



K
 Cromo lucido / Polish chrome / Chrome brillant
 Glaenzend Chrom / Cromo brillante / Хром

FINITURA VETRO / GLASS FINISHES / FINITION VERRE / GLAS-FINISH / ACABADO VIDRIO / ОТДЕЛКА СТЕКЛОМ



- AV**
 Avorio / Ivory / Ivoire
 Elfenbein / Marfil
 Слоновая кость
- BL.AMT**
 Bianco Latte Ametista
 Milky White Amethyst
 Blanc Lait Améthyste
 Milchiges Amethystviolett
 Blanco Leche Ametista
 Молочно-белый аметистовый
- BL**
 Bianco Latte Cristallo
 Milk White Clear
 Blanc Lait Cristal
 Milchweiß Kristall Blanco
 Leche Cristal
 Молочно-белый Хрусталь
- CR**
 Cristallo / Clear / Cristal
 Kristallglas / Cristal
 Хрусталь
- FU**
 Fumé / Smoked / Fumé
 Rauchfarben / Fumé
 Дымчатый



OCE
 Oceano / Ocean / Océan
 Ozeantürkis / Óceano
 Цвет морской волны



IGLOO

Design
Sylcom Glass Design









2062 K BL +
TOP 2062 BIA



2061 K BL +
TOP 2061 BIA

2060 K BL +
TOP 2060 BIA



2065 K BL



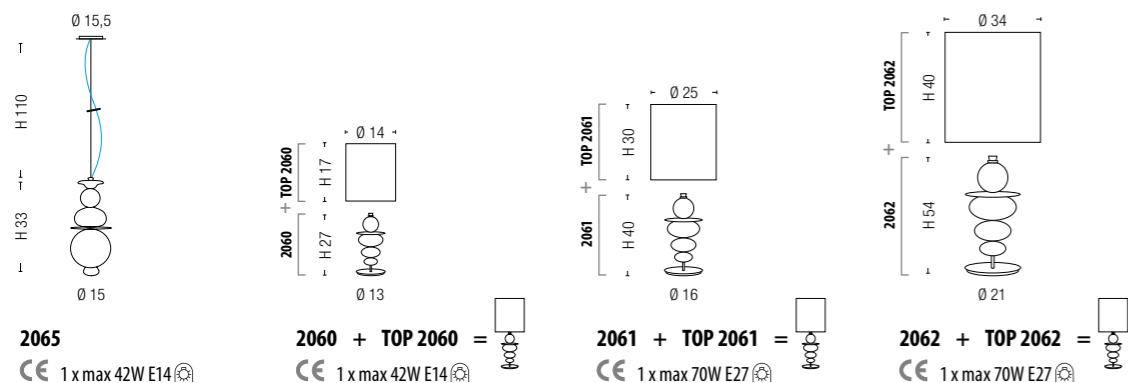

SISTEMA PER COMPOSIZIONI MULTIPLE / MULTIPLE ARRANGEMENTS / SYSTEME POUR COMPOSITIONS MULTIPLES / SYSTEM VON VIELFACH ANORDNUNGEN / SISTEMA PARA MULTIPLES COMPOSICIONES / СИСТЕМА ДЛЯ КОМПОЗИЦИИ НА НЕСКОЛЬКО ПОДВЕСНЫХ ЭЛЕМЕНТОВ

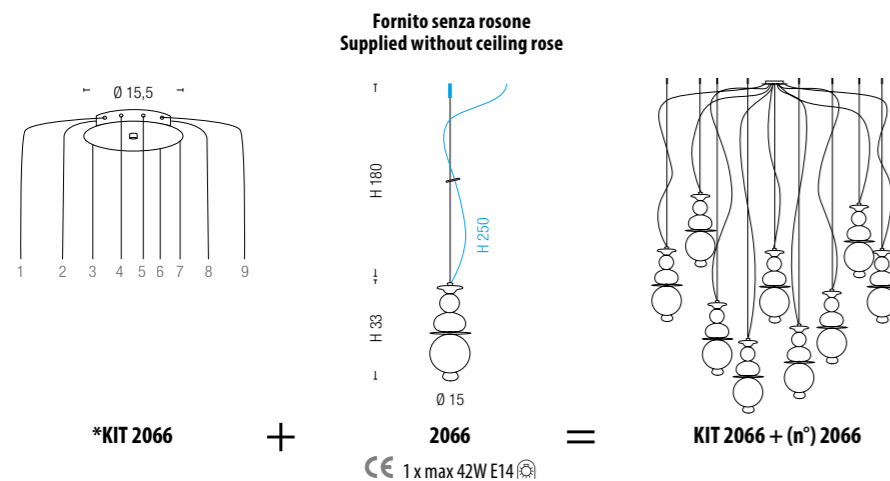

*Rosone in cromo per composizioni multiple: comunicare il nr. di uscite da inserire nel KIT (rosone). Massimo 9 uscite. / Chrome ceiling rose for multiple arrangements: please indicate the nr. of exits to be inserted in the KIT (ceiling rose). Carries maximum 9 exits. / Pavillon en chrome pour compositions multiples: svp communiquer le nombre de sorties à insérer dans le KIT (pavillon). Maxi 9 sorties. / Chrom Fensterrose fuer vielfache Anordnungen: bitte mitteilen Sie die Anzahl von Elemente, sie brauchen. Hoechstnummer: 9 Elemente. / Para realizar la composición multiple se necesita comunicar el numero de elementos para colocar en el KIT (florón). El numero maximo que se pueden colocar es de 9 elementos. / Хромированное потолочное основание на несколько подвесных светильников. Максимум 9 элементов. Для создания правильной композиции с одним потолочным основанием (KIT) на несколько подвесных элементов при заказе необходимо указывать их количество.

FINITURA METALLO / METAL FINISHES / FINITIONS MÉTAL / METALL-FINISH / ACABADOS EN METAL / ОТДЕЛКА МЕТАЛЛОМ



K
 Cromo lucido / Polish chrome / Chrome brillant
 Glaenzend Chrom / Cromo brillante / Хром

D
 Dorato lucido / Polish gold
 Doré brillant / Glaenzend Chrome / Dorado brillante
 Позолоченный

FINITURA VETRO / GLASS FINISHES / FINITION VERRE / GLAS-FINISH / ACABADO VIDRIO / ОТДЕЛКА СТЕКЛОМ



BL
 Bianco Latte Cristallo
 Milk White Clear
 Blanc Lait Cristal
 Milchweiß Kristall Bianco
 Leche Cristal
 Молочно-белый
 Хрусталь

CR
 Cristallo / Clear / Cristal
 Kristallglas / Cristal
 Хрусталь

DEN
 Denim / Blue Denim / Bleu Denim / Blau Denim / Azul Denim / Джинсовый

FU
 Fumé / Smoked / Fumé
 Rauchfarben / Fumé
 Дымчатый

GRY
 Grigio / Grey / Gris / Grau
 Gris / Серое

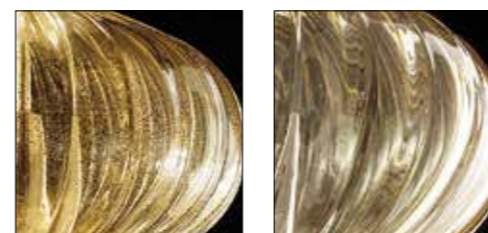

ORO
 Oro 24 Kt / 24Kt Gold
 Or 24 Kt / Gold 24 Kt
 Oro de 24 Kt Золото 24 карата

TOP
 Topazio / Topaz / Topaze
 Topas / Topacio / топазовый

FINITURA PARALUMI / LAMPSHADE FINISHES / FINITION ABAT-JOUR / AUSFÜHRUNG LAMPENSCHIRME / ACABADO PANTALLAS / ОТДЕЛКА АБАЖУРОВ



BIA
 Bianco / White / Blanc
 Weiß / Blanco / Белый



JUPITER

Design
Andrea Lazzari







36 JUPITER

0092 K AMT



0082 K DEN

JUPITER 37

JUPITER

Misure in cm / Measures in cm

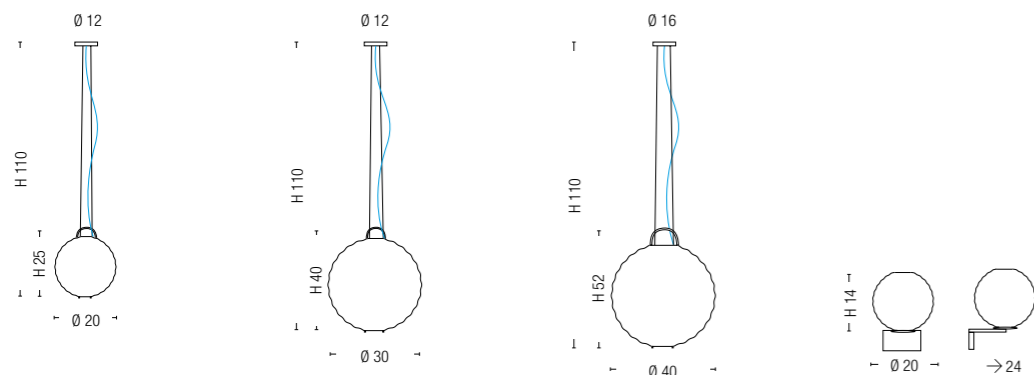

0085
 CE 1 x max 42W E14

0086
 CE 1 x max 42W E14
 CE 1 x max 35W GU10

0087
 CE 1 x max 70W E27
 CE 1 x max 35W GU10

0092
 CE 1 x max 42W E14

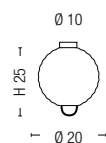

0080
 CE 1 x max 42W E14

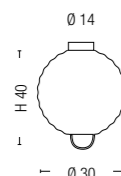

0081
 CE 1 x max 70W E27

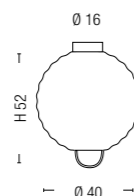

0082
 CE 1 x max 105W E27

SISTEMA PER COMPOSIZIONI MULTIPLE / MULTIPLE ARRANGEMENTS / SYSTEME POUR COMPOSITIONS MULTIPLES / SYSTEM VON VIELFACH ANORDNUNGEN / SISTEMA PARA MULTIPLES COMPOSICIONES / СИСТЕМА ДЛЯ КОМПОЗИЦИИ НА НЕСКОЛЬКО ПОДВЕСНЫХ ЭЛЕМЕНТОВ

Fornito senza rosone
 Supplied without ceiling rose

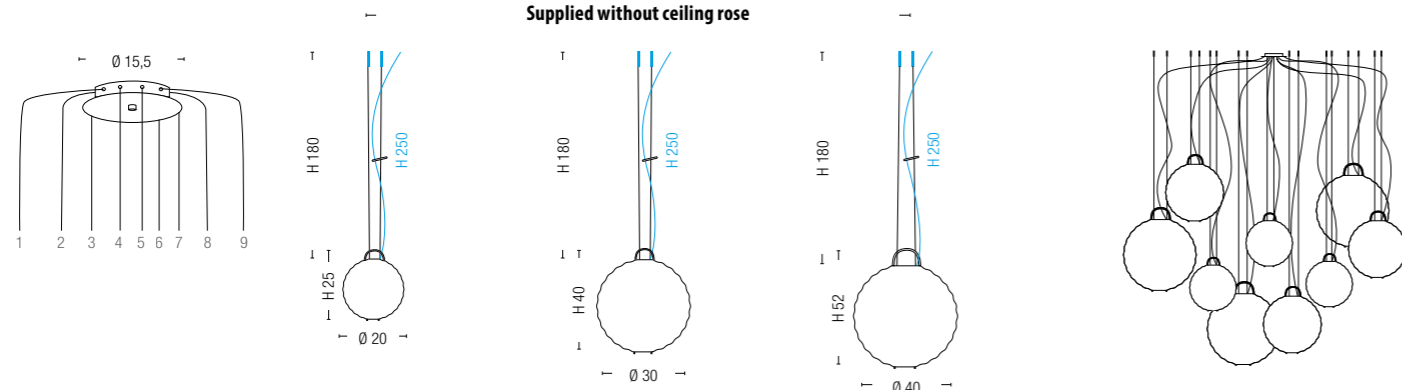

*KIT 0088 + 0088 + 0089 + 0090 = KIT 0088 + (n°) 0088 + (n°) 0089 + (n°) 0090

CE 1 x max 42W E14
 CE 1 x max 42W E14
 CE 1 x max 35W GU10
 CE 1 x max 70W E27
 CE 1 x max 35W GU10

*Rosone in cromo per composizioni multiple: comunicare il nr. di uscite da inserire nel KIT (rosone). Massimo 9 uscite. / Chrome ceiling rose for multiple arrangements: please indicate the nr. of exits to be inserted in the KIT (ceiling rose). Carries maximum 9 exits. / Pavillon en chrome pour compositions multiples: svp communiquer le nombre de sorties à insérer dans le KIT (pavillon). Maxi 9 sorties. / Chrom Fensterrose fuer vielfache Anordnungen: bitte mitteilen Sie die Anzahl von Elemente, sie brauchen. Hoehstnummer: 9 Elemente. / Para realizar la composición multiple se necesita comunicar el numero de elementos para colocar en el KIT (florón). El numero maximo que se pueden colocar es de 9 elementos. / Хромированное потолочное основание на несколько подвесных светильников. Максимум 9 элементов. Для создания правильной композиции с одним потолочным основанием (KIT) на несколько подвесных элементов при заказе необходимо указывать их количество.

FINITURA METALLO / METAL FINISHES / FINITIONS MÉTAL / METALL-FINISH / ACABADOS EN METAL / ОТДЕЛКА МЕТАЛЛОМ



K
 Cromo lucido / Polish chrome / Chrome brillant
 Glanzend Chrom / Cromo brillante / Хром

FINITURA VETRO / GLASS FINISHES / FINITION VERRE / GLAS-FINISH / ACABADO VIDRIO / ОТДЕЛКА СТЕКЛОМ

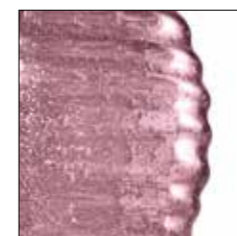

AMT
 Ametista / Amethyst
 Améthyste / Amethyst
 Amatista / Аметист



BL
 Bianco Latte Cristallo
 Milk White Clear
 Blanc Lait Cristal
 Milchweiß Kristall Blanco
 Leche Cristal
 Молочно-белый
 Хрусталь

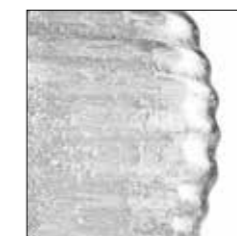

CR
 Cristallo / Clear / Cristal
 Kristallglas / Cristal
 Хрусталь



DEN
 Denim / Blue Denim / Bleu Denim / Blau Denim / Azul Denim / Джинсовый

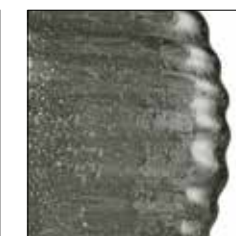

GRY
 Grigio / Grey / Gris / Grau
 Gris / Серое



TOP
 Topazio / Topaz / Topaze
 Topas / Торасио / топазовый



APHROS

Design
Oriano Favaretto









APHROS

Misure in cm / Measures in cm

0280
 1 x max 33W G9

0290
 1 x max 33W G9

0300
 1 x max 33W G9

0282
 1 x max 25W GU10

0292
 1 x max 25W GU10

0302
 1 x max 25W GU10

0283
 1 x max 33W G9

0293
 1 x max 33W G9

0303
 1 x max 33W G9

SISTEMA PER COMPOSIZIONI MULTIPLE / MULTIPLE ARRANGEMENTS / SYSTEME POUR COMPOSITIONS MULTIPLES / SYSTEM VON VIELFACH ANORDNUNGEN / SISTEMA PARA MULTIPLES COMPOSICIONES / СИСТЕМА ДЛЯ КОМПОЗИЦИИ НА НЕСКОЛЬКО ПОДВЕСНЫХ ЭЛЕМЕНТОВ

Fornito senza rosone
Supplied without ceiling rose

***KIT 0281** + **0281** + **0291** + **0301** = **KIT 0281 + (n°) 0281+ (n°) 0291+ (n°) 0301**
 1 x max 33W G9 1 x max 33W G9 1 x max 33W G9

*Rosone in cromo per composizioni multiple: comunicare il nr. di uscite da inserire nel KIT (rosone). Massimo 9 uscite. / Chrome ceiling rose for multiple arrangements: please indicate the nr. of exits to be inserted in the KIT (ceiling rose). Carries maximum 9 exits. / Pavillon en chrome pour compositions multiples: svp communiquer le nombre de sorties à insérer dans le KIT (pavillon). Maxi 9 sorties. / Chrom Fensterröse fuer vielfache Anordnungen: bitte mitteilen Sie die Anzahl von Elemente, sie brauchen. Hoechstnummer: 9 Elemente. / Para realizar la composición multiple se necesita comunicar el numero de elementos para colocar en el KIT (florón). El numero maximo que se pueden colocar es de 9 elementos. / Хромированное потолочное основание на несколько подвесных светильников. Максимум 9 элементов. Для создания правильной композиции с одним потолочным основанием (KIT) на несколько подвесных элементов при заказе необходимо указывать их количество.

FINITURA METALLO / METAL FINISHES / FINITIONS MÉTAL / METALL-FINISH / ACABADOS EN METAL / ОТДЕЛКА МЕТАЛЛОМ



NS
 Nichel spazzolato
 Bushed nickel
 Nickel brossé
 Nickel gebürstet
 Níquel cepillado
 Брашированный никель

FINITURA VETRO / GLASS FINISHES / FINITION VERRE / GLAS-FINISH / ACABADO VIDRIO / ОТДЕЛКА СТЕКЛОМ



AMT
 Ametista / Amethyst
 Améthyste / Amethyst
 Amatista / Аметист

CR
 Cristallo / Clear / Cristal
 Kristallglas / Cristal
 Хрусталь

GRY
 Grigio / Grey / Gris / Grau
 Gris / Cepoe

OCE
 Oceano / Ocean / Océan
 Ozeantürkis / Óceano
 Цвет морской волны

TOP
 Topazio / Topaz / Topaze
 Topas / Торацио / топазовый



ВІТТА

Design
Arch. Paolo Francesco Piva





56 BITTA

0011 CR



0014 TOP



BITTA 57



BITTA

Misure in cm / Measures in cm

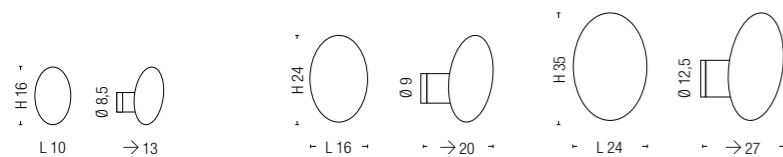

0010

CE 1 x max 25W G9

0011

CE 1 x max 42W E14

0012

CE 1 x max 70W E27

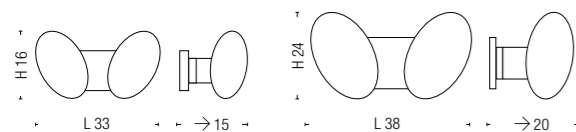

0013

CE 2 x max 25W G9

0014

CE 2 x max 42W E14

FINITURA METALLO / METAL FINISHES / FINITIONS MÉTAL / METALL-FINISH / ACABADOS EN METAL / ОТДЕЛКА МЕТАЛЛОМ



K

Cromo lucido / Polish chrome / Chrome brillant
Glaenzend Chrom / Cromo brillante / Хром

FINITURA VETRO / GLASS FINISHES / FINITION VERRE / GLAS-FINISH / ACABADO VIDRIO / ОТДЕЛКА СТЕКЛОМ



BL

Bianco Latte Cristallo
Milk White Clear
Blanc Lait Cristal
Milchweiß Kristall Blanco
Leche Cristal
Молочно-белый
Хрусталь



CR

Cristallo / Clear / Cristal
Kristallglas / Cristal
Хрусталь



FU

Fumé / Smoked / Fumé
Rauchfarben / Fumé
Дымчатый



TOP

Topazio / Topaz / Topaze
Topas / Topacio
Топазовый

CASA BLANCA

Design
Massimo Tonetto











CASA BLANCA

Misure in cm / Measures in cm

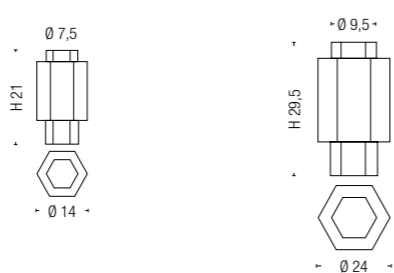
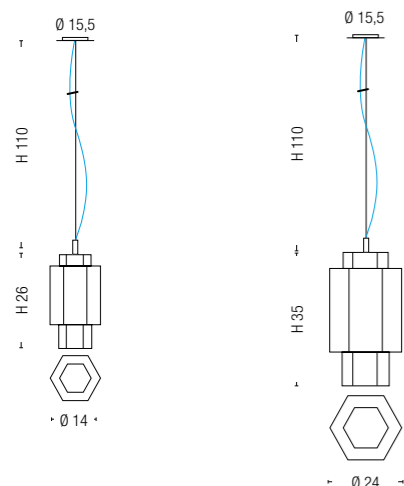

0264
 CE 1 x max 42W E14

0265
 CE 1 x max 70W E27

0260
 CE 1 x max 42W E14

0261
 CE 1 x max 70W E27

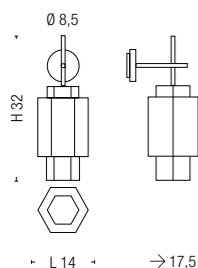

0266
 CE 1 x max 42W E14

0267
 CE 2 x max 42W E14

SISTEMA PER COMPOSIZIONI MULTIPLE / MULTIPLE ARRANGEMENTS / SYSTEME POUR COMPOSITIONS MULTIPLES / SYSTEM VON VIELFACH ANORDNUNGEN / SISTEMA PARA MULTIPLES COMPOSICIONES / СИСТЕМА ДЛЯ КОМПОЗИЦИИ НА НЕСКОЛЬКО ПОДВЕСНЫХ ЭЛЕМЕНТОВ

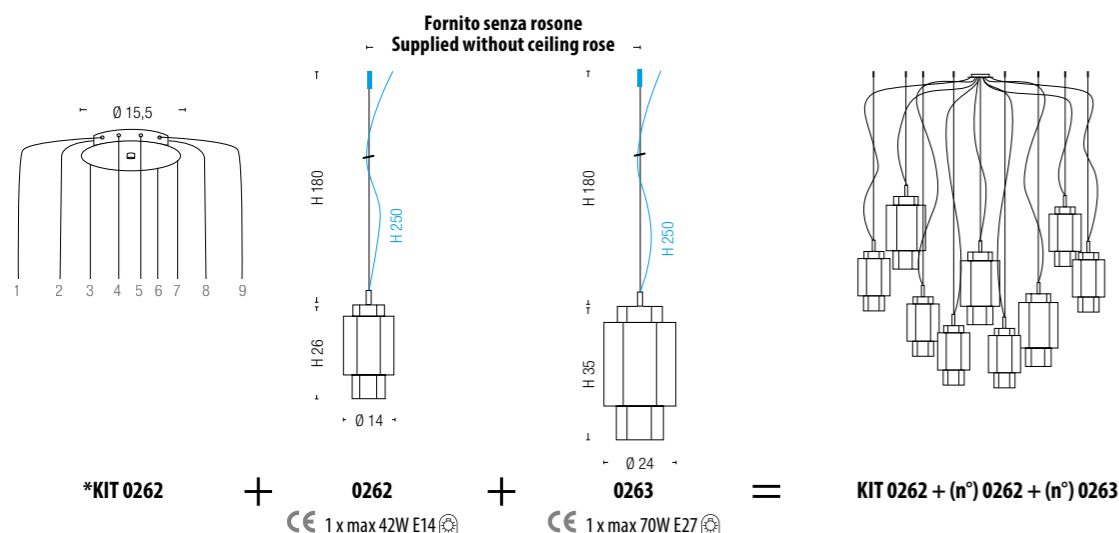

*Rosone in cromo per composizioni multiple: comunicare il nr. di uscite da inserire nel KIT (rosone). Massimo 9 uscite. / Chrome ceiling rose for multiple arrangements: please indicate the nr. of exits to be inserted in the KIT (ceiling rose). Carries maximum 9 exits. / Pavillon en chrome pour compositions multiples: svp communiquer le nombre de sorties à insérer dans le KIT (pavillon). Maxi 9 sorties. / Chrom Fensterrose fuer vielfache Anordnungen: bitte mitteilen Sie die Anzahl von Elemente, sie brauchen. Hoechstnummer: 9 Elemente. / Para realizar la composición multiple se necesita comunicar el numero de elementos para colocar en el KIT (florón). El numero maximo que se pueden colocar es de 9 elementos. / Хромированное потолочное основание на несколько подвесных светильников. Максимум 9 элементов. Для создания правильной композиции с одним потолочным основанием (KIT) на несколько подвесных элементов при заказе необходимо указывать их количество.

FINITURA METALLO / METAL FINISHES / FINITIONS MÉTAL / METALL-FINISH / ACABADOS EN METAL / ОТДЕЛКА МЕТАЛЛОМ

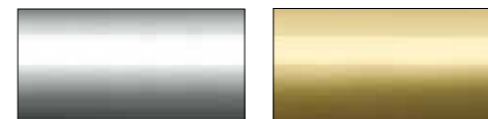

K
 Cromo lucido / Polish chrome / Chrome brillant
 Glaenzend Chrom / Cromo brillante / Хром

***D**
 Dorato lucido / Polish gold
 Doré brillant / Glaenzend Chrome / Dorado brillante
 Позолоченный

*Solo per finitura vetro GOL / For GOL glass finish only / Uniquement pour la finition verre GOL / Nur für Glasausführung GOL / Sólo para acabado vidrio GOL / Только для отделки стекла GOL

FINITURA VETRO / GLASS FINISHES / FINITION VERRE / GLAS-FINISH / ACABADO VIDRIO / ОТДЕЛКА СТЕКЛОМ



AMT
 Ametista / Amethyst
 Améthyste / Amethyst
 Аметист

BL
 Bianco Latte Cristallo
 Milk White Clear
 Blanc Lait Cristal
 Milchweiß Kristall Blanco
 Leche Cristal
 Молочно-белый
 Хрусталь

CR
 Cristallo / Clear / Cristal
 Kristallglas / Cristal
 Хрусталь

FU
 Fumé / Smoked / Fumé
 Rauchfarben / Fumé
 Дымчатый

GOL
 Ambra specchiato / Amber mirror finish / Ambre miroir
 Bernstein spiegelglanz
 Ambar espejado
 Янтарный зеркальный цвет

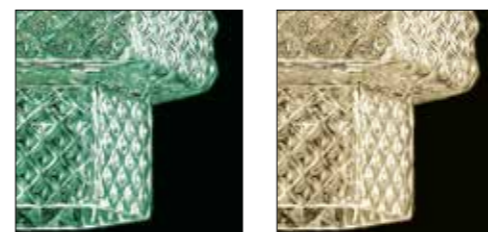

OCE
 Oceano / Ocean / Océan
 Ozeantürkis / Óceano
 Цвет морской волны

TOP
 Topazio / Topaz / Topaze
 Topas / Topacio / топазовый



CHAOTIC

Design
Massimo Tonetto







0199 FU +
TOP 0199 AV



0198 OCE +
TOP 0198 WE



0199 BL +
TOP 0199 WE





84 CHAOTIC

0195 CR



0195 TOP

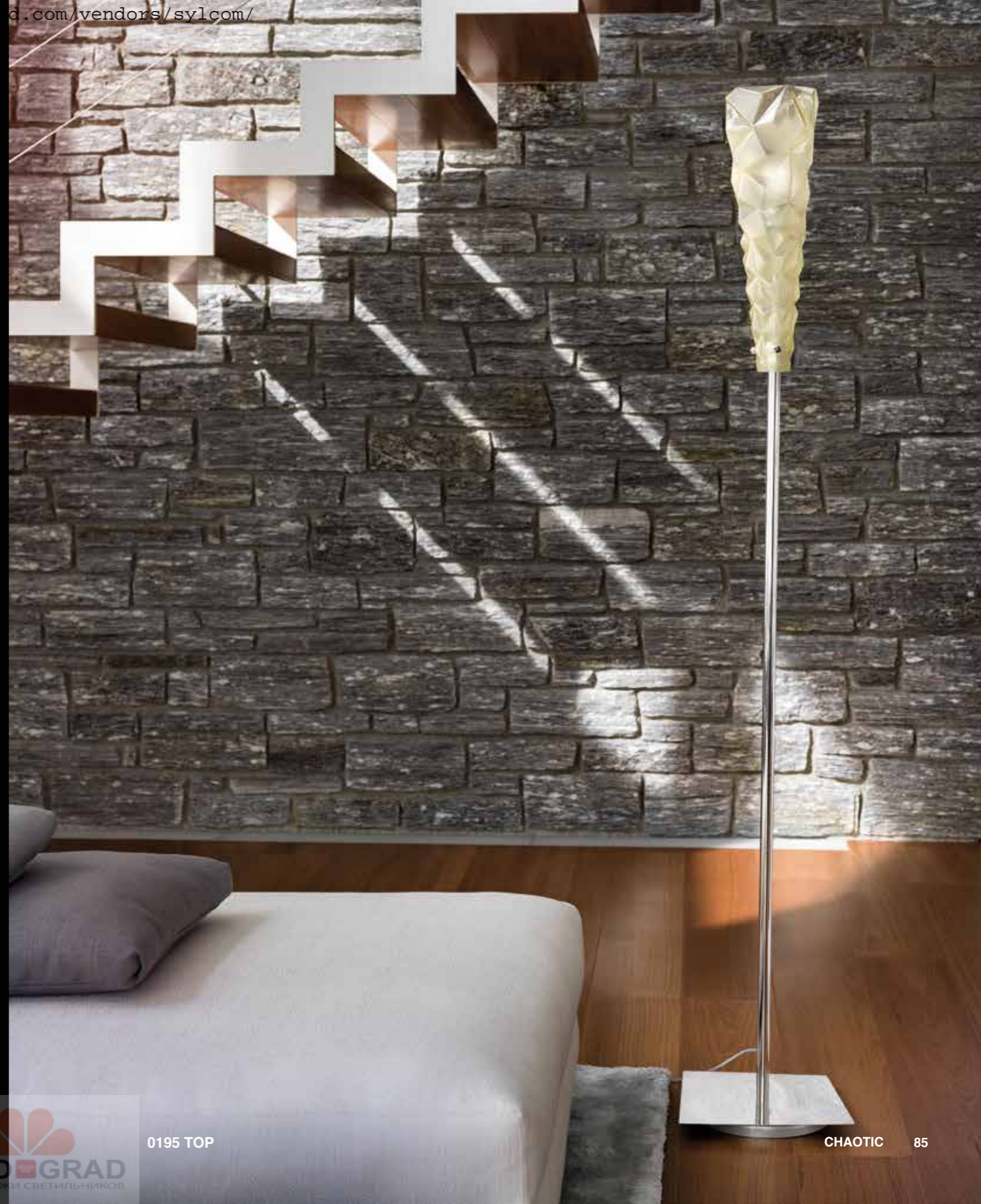

CHAOTIC 85

CHAOTIC

Misure in cm / Measures in cm

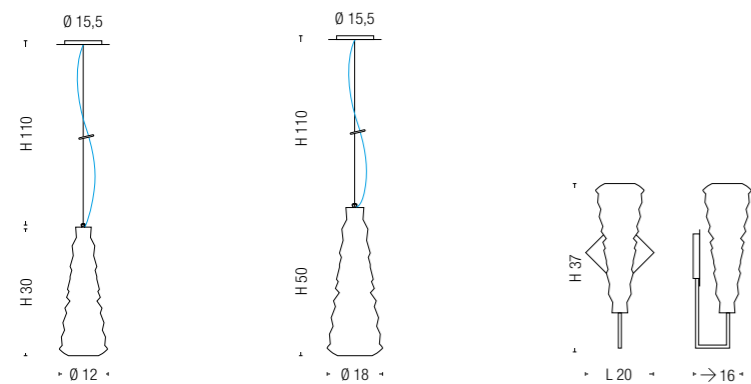

0190 1 x max 42W E14
0191 1 x max 70W E27
0194 1 x max 42W E14

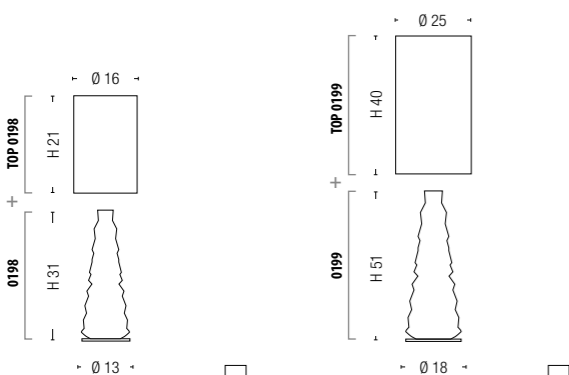

0198 + TOP 0198 =
 1 x max 42W E14
0199 + TOP 0199 =
 1 x max 70W E27



0195 1 x max 70W E27

SISTEMA PER COMPOSIZIONI MULTIPLE / MULTIPLE ARRANGEMENTS / SYSTEME POUR COMPOSITIONS MULTIPLES / SYSTEM VON VIELFACH ANORDNUNGEN / SISTEMA PARA MULTIPLES COMPOSICIONES / СИСТЕМА ДЛЯ КОМПОЗИЦИИ НА НЕСКОЛЬКО ПОДВЕСНЫХ ЭЛЕМЕНТОВ

Fornito senza rosone
 - Supplied without ceiling rose -

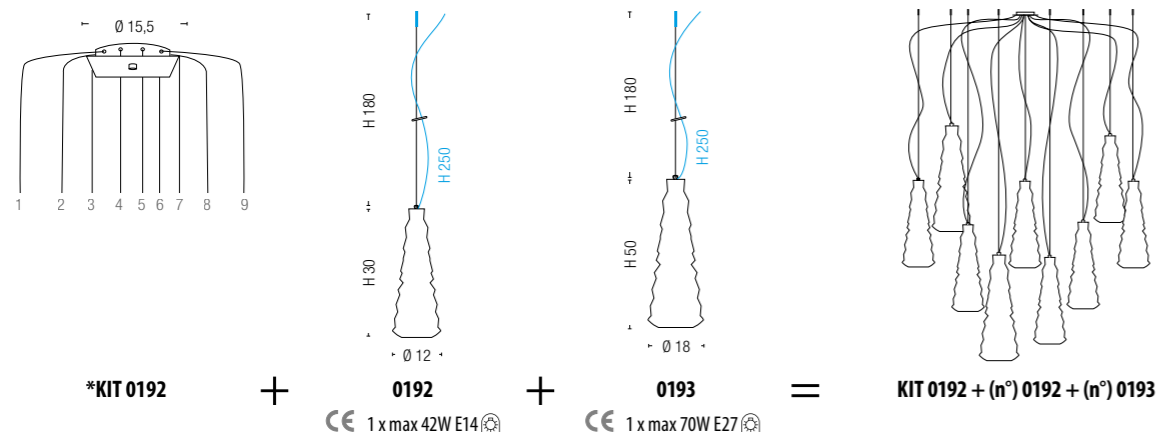

***KIT 0192** + **0192** + **0193** = **KIT 0192 + (n°) 0192 + (n°) 0193**
 1 x max 42W E14 1 x max 70W E27

*Rosone in cromo per composizioni multiple: comunicare il nr. di uscite da inserire nel KIT (rosone). Massimo 9 uscite. / Chrome ceiling rose for multiple arrangements: please indicate the nr. of exits to be inserted in the KIT (ceiling rose). Carries maximum 9 exits. / Pavillon en chrome pour compositions multiples: svp communiquer le nombre de sorties à insérer dans le KIT (pavillon). Maxi 9 sorties. / Chrom Fensterrose fuer vielfache Anordnungen: bitte mitteilen Sie die Anzahl von Elemente, sie brauchen. Hoechstnummer: 9 Elemente. / Para realizar la composición multiple se necesita comunicar el numero de elementos para colocar en el KIT (florón). El numero maximo que se pueden colocar es de 9 elementos. / Хромированное потолочное основание на несколько подвесных светильников. Максимум 9 элементов. Для создания правильной композиции с одним потолочным основанием (KIT) на несколько подвесных элементов при заказе необходимо указывать их количество.

FINITURA METALLO / METAL FINISHES / FINITIONS MÉTAL / METALL-FINISH / ACABADOS EN METAL / ОТДЕЛКА МЕТАЛЛОМ



K
 Cromo lucido / Polish chrome / Chrome brillant
 Glanzend Chrom / Cromo brillante / Хром

FINITURA VETRO / GLASS FINISHES / FINITION VERRE / GLAS-FINISH / ACABADO VIDRIO / ОТДЕЛКА СТЕКЛОМ



AMT
 Ametista / Amethyst
 Améthyste / Amethyst
 Amatista / Аметист



BL
 Bianco Latte Cristallo
 Milk White Clear
 Blanc Lait Cristal
 Milchweiß Kristall Blanco
 Leche Cristal
 Молочно-белый
 Хрусталь



CR
 Cristallo / Clear / Cristal
 Kristallglas / Cristal
 Хрусталь



FU
 Fumé / Smoked / Fumé
 Rauchfarben / Fumé
 Дымчатый



OCE
 Oceano / Ocean / Océan
 Ozeantürkis / Óceano
 Цвет морской волны



TOP
 Topazio / Topaz / Topaze
 Торас / Торасио / топазовый

FINITURA PARALUMI / LAMPSHADE FINISHES / FINITION ABAT-JOUR / AUSFÜHRUNG LAMPENSCHIRME / ACABADO PANTALLAS / ОТДЕЛКА АБАЖУРОВ



AV
 Avorio / Ivory / Ivoire
 Elfenbein / Marfil / Цвет слоновой кости



GR
 Gravel / Gravel / Gravier
 Kies / Gravilla / Цвет гравия



WE
 Wengé / Wengé / Wengé
 Wenge / Wengué / Венге



EMI SPHERA

Design
Sylcom Glass Design

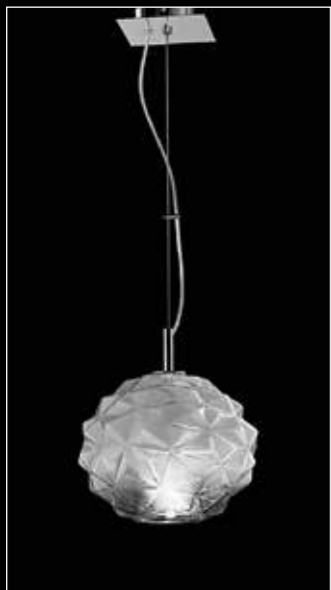







0212 BL +
TOP 0212 WE



0211 TOP +
TOP 0211 GR



0212 AMT +
TOP 0212 AV



EMISPHERA

Misure in cm / Measures in cm

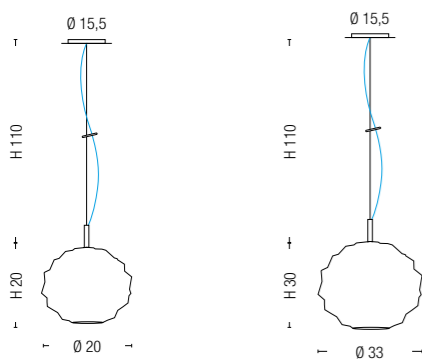

0200
 CE 1 x max 42W E14

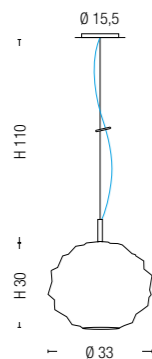

0201
 CE 1 x max 70W E27

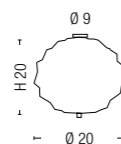

0204
 CE 1 x max 42W E14

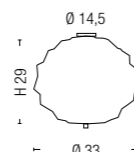

0205
 CE 3 x max 42W E14

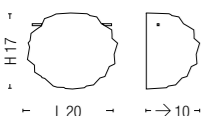

0206
 CE 1 x max 42W E14

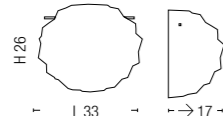

0207
 CE 2 x max 42W E14

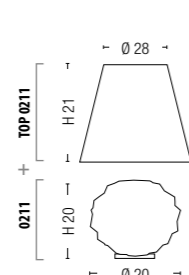

0211 + TOP 0211 =

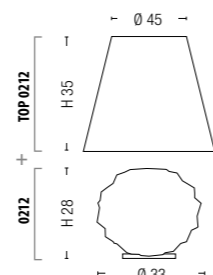

0212 + TOP 0212 =

SISTEMA PER COMPOSIZIONI MULTIPLE / MULTIPLE ARRANGEMENTS / SYSTEME POUR COMPOSITIONS MULTIPLES / SYSTEM VON VIELFACH ANORDNUNGEN / SISTEMA PARA MULTIPLES COMPOSICIONES / СИСТЕМА ДЛЯ КОМПОЗИЦИИ НА НЕСКОЛЬКО ПОДВЕСНЫХ ЭЛЕМЕНТОВ

Fornito senza rosone
 - Supplied without ceiling rose -

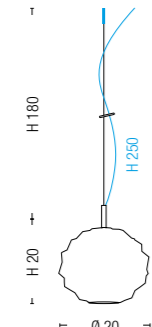
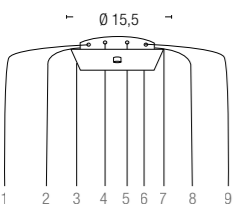

***KIT 0202** + **0202**
 CE 1 x max 42W E14

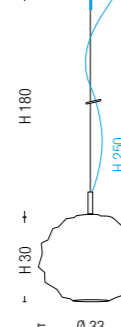

+ **0203**
 CE 1 x max 70W E27

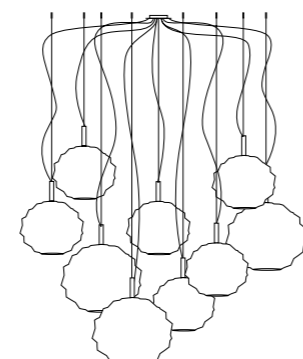

= **KIT 0202 + (n°) 0202 + (n°) 0203**

*Rosone in cromo per composizioni multiple: comunicare il nr. di uscite da inserire nel KIT (rosone). Massimo 9 uscite. / Chrome ceiling rose for multiple arrangements: please indicate the nr. of exits to be inserted in the KIT (ceiling rose). Carries maximum 9 exits. / Pavillon en chrome pour compositions multiples: svp communiquer le nombre de sorties à insérer dans le KIT (pavillon). Maxi 9 sorties. / Chrom Fensterrose fuer vielfache Anordnungen: bitte mitteilen Sie die Anzahl von Elemente, sie brauchen. Hoechstnummer: 9 Elemente. / Para realizar la composición multiple se necesita comunicar el numero de elementos para colocar en el KIT (florón). El numero maximo que se pueden colocar es de 9 elementos. / Хромированное потолочное основание на несколько подвесных светильников. Максимум 9 элементов. Для создания правильной композиции с одним потолочным основанием (KIT) на несколько подвесных элементов при заказе необходимо указывать их количество.

FINITURA METALLO / METAL FINISHES / FINITIONS MÉTAL / METALL-FINISH / ACABADOS EN METAL / ОТДЕЛКА МЕТАЛЛОМ



K
 Cromo lucido / Polish chrome / Chrome brillant / Glänzend Chrom / Cromo brillante / Хром

FINITURA VETRO / GLASS FINISHES / FINITION VERRE / GLAS-FINISH / ACABADO VIDRIO / ОТДЕЛКА СТЕКЛОМ



AMT
 Ametista / Amethyst / Améthyste / Amethyst / Аметист



BL
 Bianco Latte Cristallo / Milk White Clear / Blanc Lait Cristal / Milchweiß Kristall Blanco / Leche Cristal / Молочно-белый Хрусталь



CR
 Cristallo / Clear / Cristal / Kristallglas / Cristal / Хрусталь



FU
 Fumé / Smoked / Fumé / Rauchfarben / Fumé / Дымчатый



OCE
 Oceano / Ocean / Océan / Ozeantürkis / Oceano / Цвет морской волны



TOP
 Topazio / Topaz / Topaze / Topas / Торазіо / топазовый

FINITURA PARALUMI / LAMPSHADE FINISHES / FINITION ABAT-JOUR / AUSFÜHRUNG LAMPENSCHIRME / ACABADO PANTALLAS / ОТДЕЛКА АБАЖУРОВ



AV
 Avorio / Ivory / Ivoire / Elfenbein / Marfil / Цвет слоновой кости



GR
 Gravel / Gravel / Gravier / Kies / Gravilla / Цвет гравия



WE
 Wengé / Wengé / Wengé / Wenge / Wengué / Венге



MASK

Design
Andrea Lazzari



0122 AMT



0123 BL



MASK 105













MASK

Misure in cm / Measures in cm

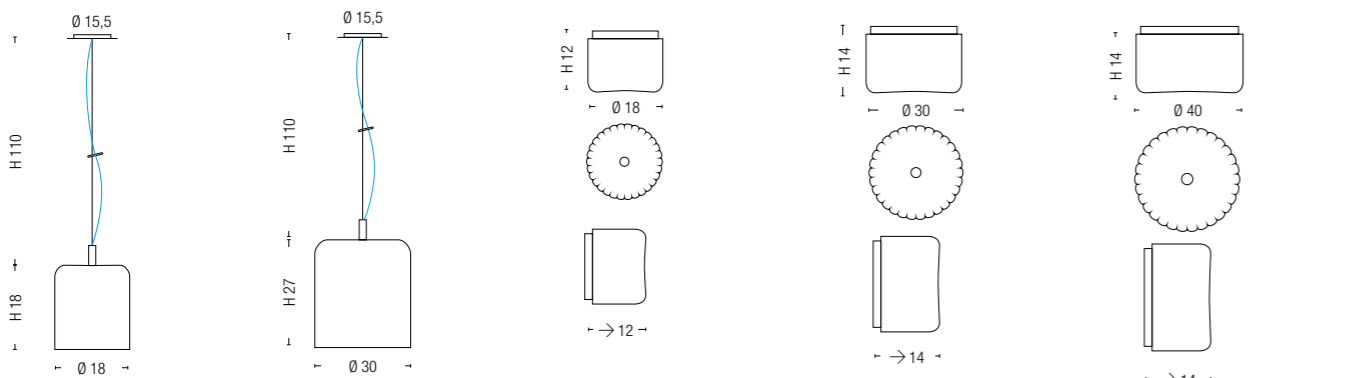

0122 CE 1 x max 42W E14
0123 CE 1 x max 70W E27
0120 CE 2 x max 40W G9
0131 CE 3 x max 42W E14
0121 CE 4 x max 70W E27

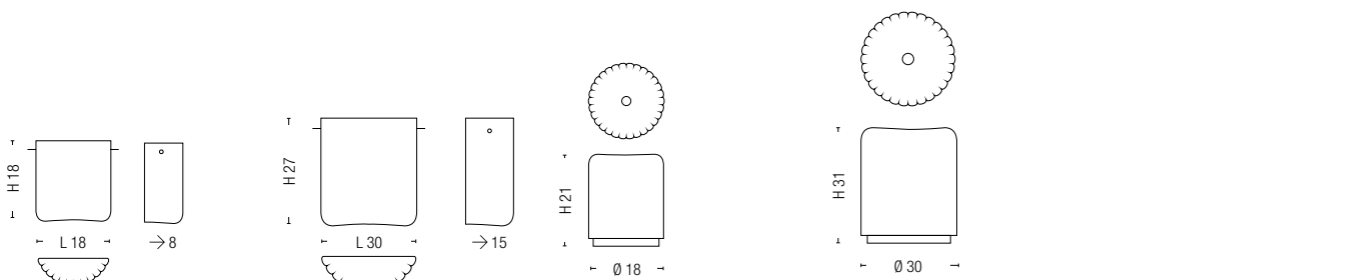

0126 CE 1 x max 40W G9
0127 CE 2 x max 42W E14
0128 CE 1 x max 42W E14
0129 CE 1 x max 70W E27

SISTEMA PER COMPOSIZIONI MULTIPLE / MULTIPLE ARRANGEMENTS / SYSTEME POUR COMPOSITIONS MULTIPLES / SYSTEM VON VIELFACH ANORDNUNGEN / SISTEMA PARA MULTIPLES COMPOSICIONES / СИСТЕМА ДЛЯ КОМПОЗИЦИИ НА НЕСКОЛЬКО ПОДВЕСНЫХ ЭЛЕМЕНТОВ

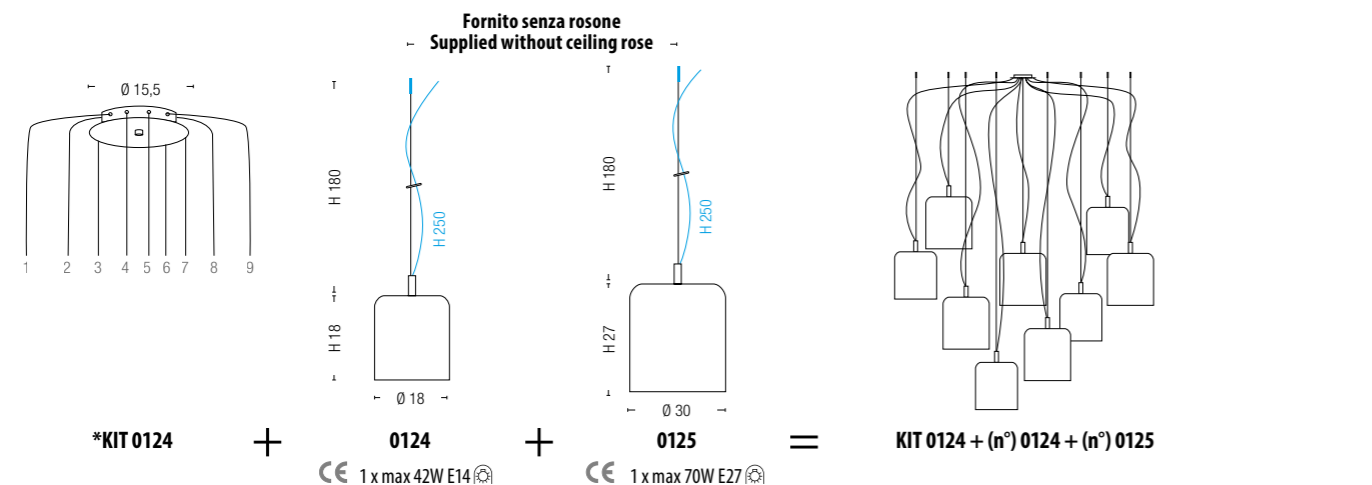

*Rosone in cromo per composizioni multiple: comunicare il nr. di uscite da inserire nel KIT (rosone). Massimo 9 uscite. / Chrome ceiling rose for multiple arrangements: please indicate the nr. of exits to be inserted in the KIT (ceiling rose). Carries maximum 9 exits. / Pavillon en chrome pour compositions multiples: svp communiquer le nombre de sorties à insérer dans le KIT (pavillon). Maxi 9 sorties. / Chrom Fensterrose fuer vielfache Anordnungen: bitte mitteilen Sie die Anzahl von Elemente, sie brauchen. Hoechstnummer: 9 Elemente. / Para realizar la composición multiple se necesita comunicar el numero de elementos para colocar en el KIT (florón). El numero maximo que se pueden colocar es de 9 elementos. / Хромированное потолочное основание на несколько подвесных светильников. Максимум 9 элементов. Для создания правильной композиции с одним потолочным основанием (KIT) на несколько подвесных элементов при заказе необходимо указывать их количество.

FINITURA METALLO / METAL FINISHES / FINITIONS MÉTAL / METALL-FINISH / ACABADOS EN METAL / ОТДЕЛКА МЕТАЛЛОМ



***B** Bianco / White / Blanc / Weiß / Blanco / Белый
K Cromo lucido / Polish chrome / Chrome brillant / Glänzend Chrom / Cromo brillante / Xром

* Solo per art. 0120 - 0121 - 0128 - 0129 - 0131
 Only for items 0120 - 0121 - 0128 - 0129 - 0131

FINITURA VETRO / GLASS FINISHES / FINITION VERRE / GLAS-FINISH / ACABADO VIDRIO / ОТДЕЛКА СТЕКЛОМ



AMT Ametista / Amethyst / Améthyste / Амethyst
AS Ambra Sommerso / Submerged Amber / Ambre Profond / Tauch-Bernstein / Âmbar Sumergido / Янтарь Соммерсо
AV Avorio / Ivory / Ivoire / Elfenbein / Marfil / Слоновая кость
BL Bianco Latte Cristallo / Milk White Clear / Blanc Lait Cristal / Milchweiß Kristall Bianco / Leche Cristal / Молочно-белый / Хрусталь
CR Cristallo / Clear / Cristal / Kristallglas / Cristal / Хрусталь



DEN Denim / Blue Denim / Bleu Denim / Blau Denim / Azul Denim / Джинсовый
FU Fumé / Smoked / Fumé / Rauchfarben / Fumé / Дымчатый



DIVA

Design
Massimo Tonetto







126 DIVA

0220 AMT

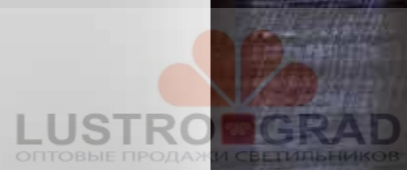

0220 BL



DIVA 127

DIVA

Misure in cm / Measures in cm

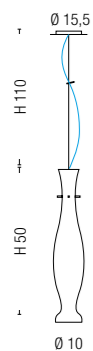

0220

CE 1 x max 75W GU10

SISTEMA PER COMPOSIZIONI MULTIPLE / MULTIPLE ARRANGEMENTS / SYSTEME POUR COMPOSITIONS MULTIPLES / SYSTEM VON VIELFACH ANORDNUNGEN / SISTEMA PARA MULTIPLES COMPOSICIONES / СИСТЕМА ДЛЯ КОМПОЗИЦИИ НА НЕСКОЛЬКО ПОДВЕСНЫХ ЭЛЕМЕНТОВ

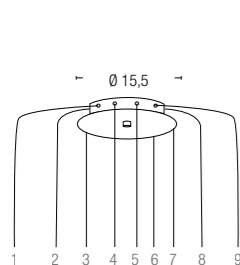

*KIT 0221



Fornito senza rosone
Supplied without ceiling rose

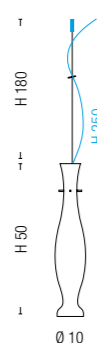

0221

CE 1 x max 75W GU10

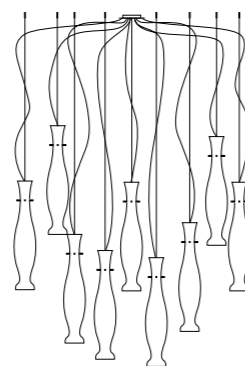

KIT 0221 + (n°) 0221

*Rosone in cromo per composizioni multiple: comunicare il nr. di uscite da inserire nel KIT (rosone). Massimo 9 uscite. / Chrome ceiling rose for multiple arrangements: please indicate the nr. of exits to be inserted in the KIT (ceiling rose). Carries maximum 9 exits. / Pavillon en chrome pour compositions multiples: svp communiquer le nombre de sorties à insérer dans le KIT (pavillon). Maxi 9 sorties. / Chrom Fensterrose fuer vielfache Anordnungen: bitte mitteilen Sie die Anzahl von Elemente, sie brauchen. Hoechstnummer: 9 Elemente. / Para realizar la composición multiple se necesita comunicar el numero de elementos para colocar en el KIT (florón). El numero maximo que se pueden colocar es de 9 elementos. / Хромированное потолочное основание на несколько подвесных светильников. Максимум 9 элементов. Для создания правильной композиции с одним потолочным основанием (KIT) на несколько подвесных элементов при заказе необходимо указывать их количество.

FINITURA METALLO / METAL FINISHES / FINITIONS MÉTAL / METALL-FINISH / ACABADOS EN METAL / ОТДЕЛКА МЕТАЛЛОМ



K

Cromo lucido / Polish chrome / Chrome brillant
Glaenzend Chrom / Cromo brillante / Хром

FINITURA VETRO / GLASS FINISHES / FINITION VERRE / GLAS-FINISH / ACABADO VIDRIO / ОТДЕЛКА СТЕКЛОМ

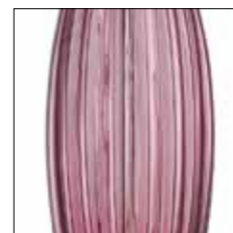

AMT

Ametista / Amethyst
Améthyste / Amethyst
Аметист / Аметист

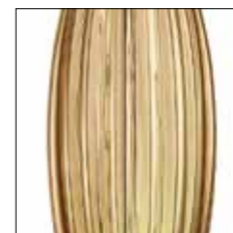

AS

Ambra Sommerso
Submerged Amber
Ambre Profond
Tauch-Bernstein
Амбар Сумергидо
Янтарь Соммерсо



AV

Avorio / Ivory / Ivoire
Elfenbein / Marfil
Слоновая кость

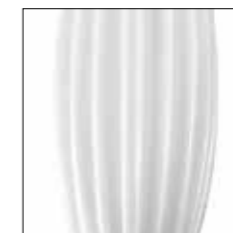

BL

Bianco Latte Cristallo
Milk White Clear
Blanc Lait Cristal
Milchweiß Kristall Blanco
Leche Cristal
Молочно-белый Хрусталь

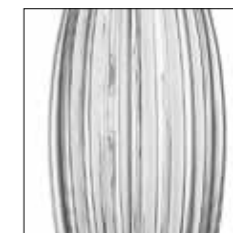

CR

Cristallo / Clear / Cristal
Kristallglas / Cristal
Хрусталь



DEN

Denim / Blue Denim / Bleu Denim / Blau Denim / Azul Denim / Джинсовый



FU

Fumé / Smoked / Fumé
Rauchfarben / Fumé
Дымчатый



SPHERA

Design
Massimo Tonetto

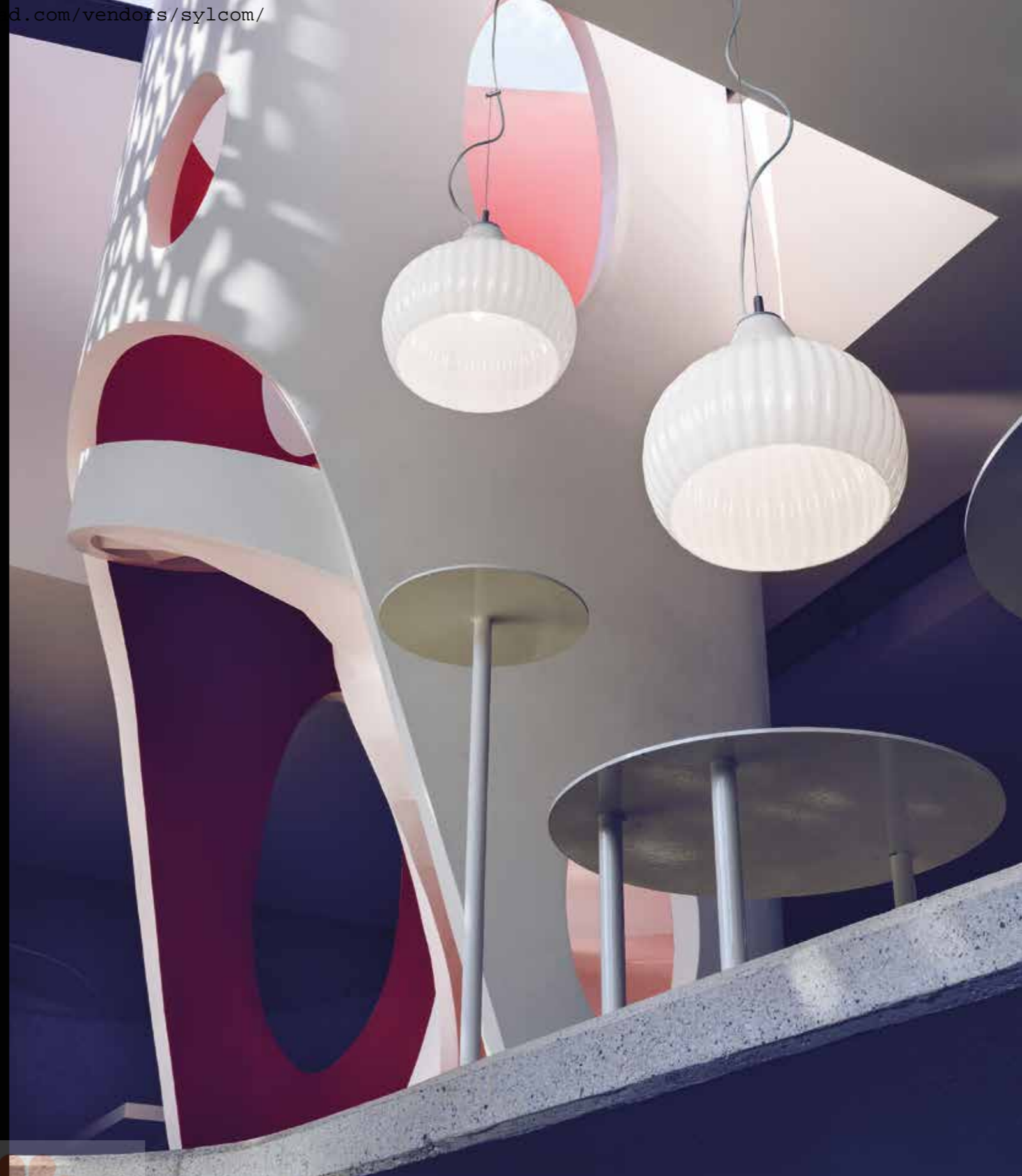



0244 AS - 0243 DEN



0242 AV



SPHERA 135





SPHERA

Misure in cm / Measures in cm

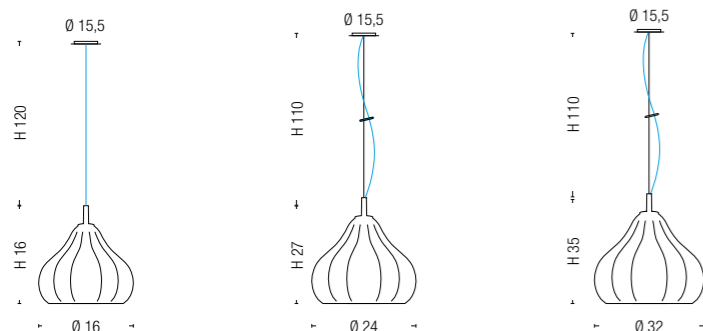

0240
 CE 1 x max 60W G9

0241
 CE 1 x max 42W E14

0242
 CE 1 x max 70W E27

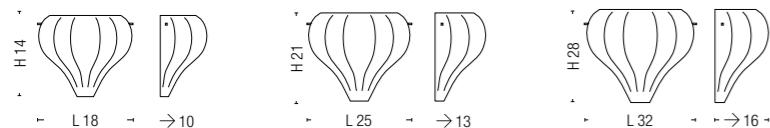

0246
 CE 1 x max 60W G9

0247
 CE 1 x max 42W E14

0248
 CE 2 x max 42W E14

SISTEMA PER COMPOSIZIONI MULTIPLE / MULTIPLE ARRANGEMENTS / SYSTEME POUR COMPOSITIONS MULTIPLES / SYSTEM VON VIELFACH ANORDNUNGEN / SISTEMA PARA MULTIPLES COMPOSICIONES / СИСТЕМА ДЛЯ КОМПОЗИЦИИ НА НЕКОЛЬКО ПОДВЕСНЫХ ЭЛЕМЕНТОВ

Fornito senza rosone
 Supplied without ceiling rose

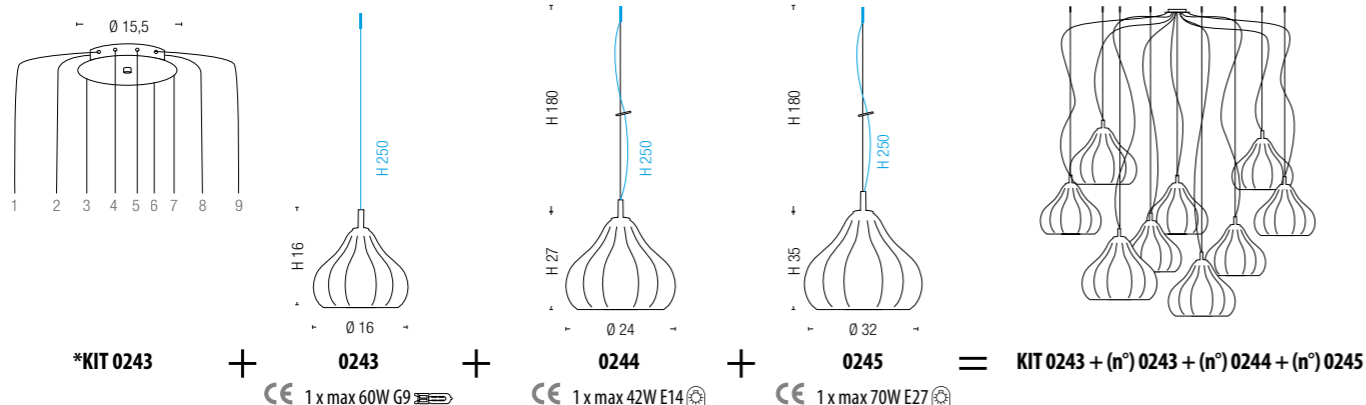

*Rosone in cromo per composizioni multiple: comunicare il nr. di uscite da inserire nel KIT (rosone). Massimo 9 uscite. / Chrome ceiling rose for multiple arrangements: please indicate the nr. of exits to be inserted in the KIT (ceiling rose). Carries maximum 9 exits. / Pavillon en chrome pour compositions multiples: svp communiquer le nombre de sorties à insérer dans le KIT (pavillon). Maxi 9 sorties. / Chrom Fensterrose fuer vielfache Anordnungen: bitte mitteilen Sie die Anzahl von Elemente, sie brauchen. Hoechstnummer: 9 Elemente. / Para realizar la composición multiple se necesita comunicar el numero de elementos para colocar en el KIT (florón). El numero maximo que se pueden colocar es de 9 elementos. / Хромированное потолочное основание на несколько подвесных светильников. Максимум 9 элементов. Для создания правильной композиции с одним потолочным основанием (KIT) на несколько подвесных элементов при заказе необходимо указывать их количество.

FINITURA METALLO / METAL FINISHES / FINITIONS MÉTAL / METALL-FINISH / ACABADOS EN METAL / ОТДЕЛКА МЕТАЛЛОМ



K
 Cromo lucido / Polish chrome / Chrome brillant
 Glanzend Chrom / Cromo brillante / Хром

FINITURA VETRO / GLASS FINISHES / FINITION VERRE / GLAS-FINISH / ACABADO VIDRIO / ОТДЕЛКА СТЕКЛОМ



AMT
 Ametista / Amethyst
 Améthyste / Амethyst
 Amatista / Аметист

AS
 Ambra Sommerso
 Submerged Amber
 Ambre Profond
 Tauch-Bernstein
 Âmbar Sumergido
 Янтарь Соммерсо

AV
 Avorio / Ivory / Ivoire
 Elfenbein / Marfil
 Слоновая кость

BL
 Bianco Latte Cristallo
 Milk White Clear
 Blanc Lait Cristal
 Milchweiß Kristall Blanco
 Leche Cristal
 Молочно-белый
 Хрусталь

CR
 Cristallo / Clear / Cristal
 Kristallglas / Cristal
 Хрусталь



DEN
 Denim / Blue Denim / Bleu
 Denim / Blau Denim / Azul
 Деним / Джинсовый

FU
 Fumé / Smoked / Fumé
 Rauchfarben / Fumé
 Дымчатый

KORINTHOS

Design
Arch. Paolo Francesco Piva



144 KORINTHOS



0046 BLCR.GRY - 0047 BLCR.GRY

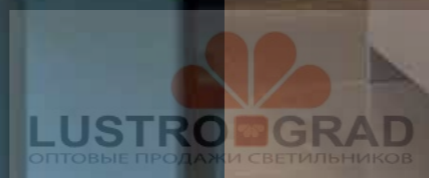

0041 BLCR.GRY

KORINTHOS 145









152 KORINTHOS

0036 TOP



0037 BL



KORINTHOS 153

KORINTHOS

Misure in cm / Measures in cm

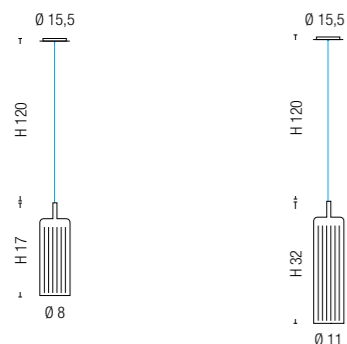

0030
 CE 1 x max 42W E14

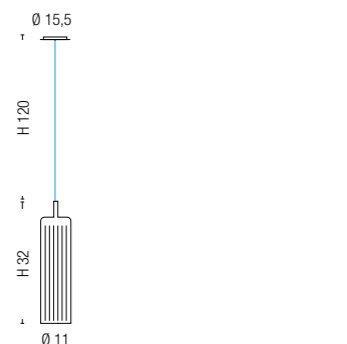

0031
 CE 1 x max 70W E27

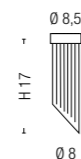

0046
 CE 1 x max 42W E14

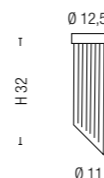

0047
 CE 1 x max 70W E27

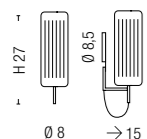

0036
 CE 1 x max 42W E14

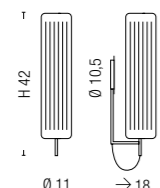

0037
 CE 1 x max 70W E27

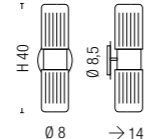

0038
 CE 2 x max 42W E14

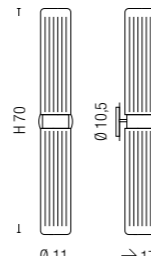

0039
 CE 2 x max 70W E27

SISTEMA PER COMPOSIZIONI MULTIPLE / MULTIPLE ARRANGEMENTS / SYSTEME POUR COMPOSITIONS MULTIPLES / SYSTEM VON VIELFACH ANORDNUNGEN / SISTEMA PARA MULTIPLES COMPOSICIONES / СИСТЕМА ДЛЯ КОМПОЗИЦИИ НА НЕСКОЛЬКО ПОДВЕСНЫХ ЭЛЕМЕНТОВ

Fornito senza rosone
 Supplied without ceiling rose

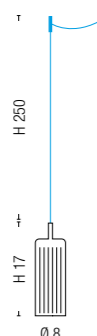
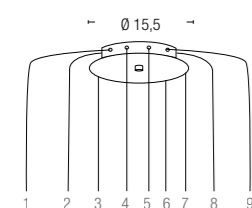

***KIT 0040** + **0040**
 CE 1 x max 42W E14

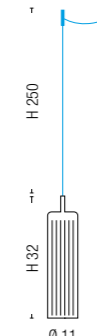

+ **0041**
 CE 1 x max 70W E27

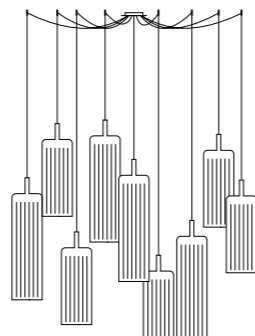

= **KIT 0040 + (n°) 0040 + (n°) 0041**

*Rosone in cromo per composizioni multiple: comunicare il nr. di uscite da inserire nel KIT (rosone). Massimo 9 uscite. / Chrome ceiling rose for multiple arrangements: please indicate the nr. of exits to be inserted in the KIT (ceiling rose). Carries maximum 9 exits. / Pavillon en chrome pour compositions multiples: svp communiquer le nombre de sorties à insérer dans le KIT (pavillon). Maxi 9 sorties. / Chrom Fensterrose fuer vielfache Anordnungen: bitte mitteilen Sie die Anzahl von Elemente, sie brauchen. Hoechstnummer: 9 Elemente. / Para realizar la composición multiple se necesita comunicar el numero de elementos para colocar en el KIT (florón). El numero maximo que se pueden colocar es de 9 elementos. / Хромированное потолочное основание на несколько подвесных светильников. Максимум 9 элементов. Для создания правильной композиции с одним потолочным основанием (KIT) на несколько подвесных элементов при заказе необходимо указывать их количество.

FINITURA METALLO / METAL FINISHES / FINITIONS MÉTAL / METALL-FINISH / ACABADOS EN METAL / ОТДЕЛКА МЕТАЛЛОМ



K
 Cromo lucido / Polish chrome / Chrome brillant / Glaenzend Chrom / Cromo brillante / Хром

FINITURA VETRO / GLASS FINISHES / FINITION VERRE / GLAS-FINISH / ACABADO VIDRIO / ОТДЕЛКА СТЕКЛОМ



BL
 Bianco Latte Cristallo / Milk White Clear / Blanc Lait Cristal / Milchweiß Kristall Blanco / Leche Cristal / Молочно-Белый / Хрусталь



BLCR.DEN
 Biancolatte-Cristallo Denim / Milky White Clear and Denim / Blanc Lait, Transparent et Bleu Denim / Weiss Milch, Transparent und Blau Denim / Blanco Leche, Transparente y Azul Denim / Молочно-Белый - Прозрачный И Джинсовый



BLCR.GRY
 Biancolatte-Cristallo Grigio / Milky White Clear and Grey / Blanc Lait, Transparent et Gris / Weiss Milch, Transparent und Grau / Blanco Leche, Transparente y Gris / Молочно-Белый - Прозрачный И Серый



CR
 Cristallo / Clear / Cristal / Kristallglas / Cristal / Хрусталь



FU
 Fumé / Smoked / Fumé / Rauchfarben / Fumé / Дымчатый

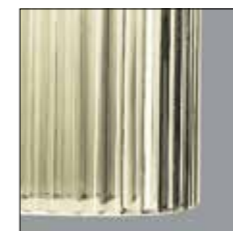

TOP
 Topazio / Topaz / Topaze / Topas / Торацио / топазовый



TRON

Design
Oriano Favaretto

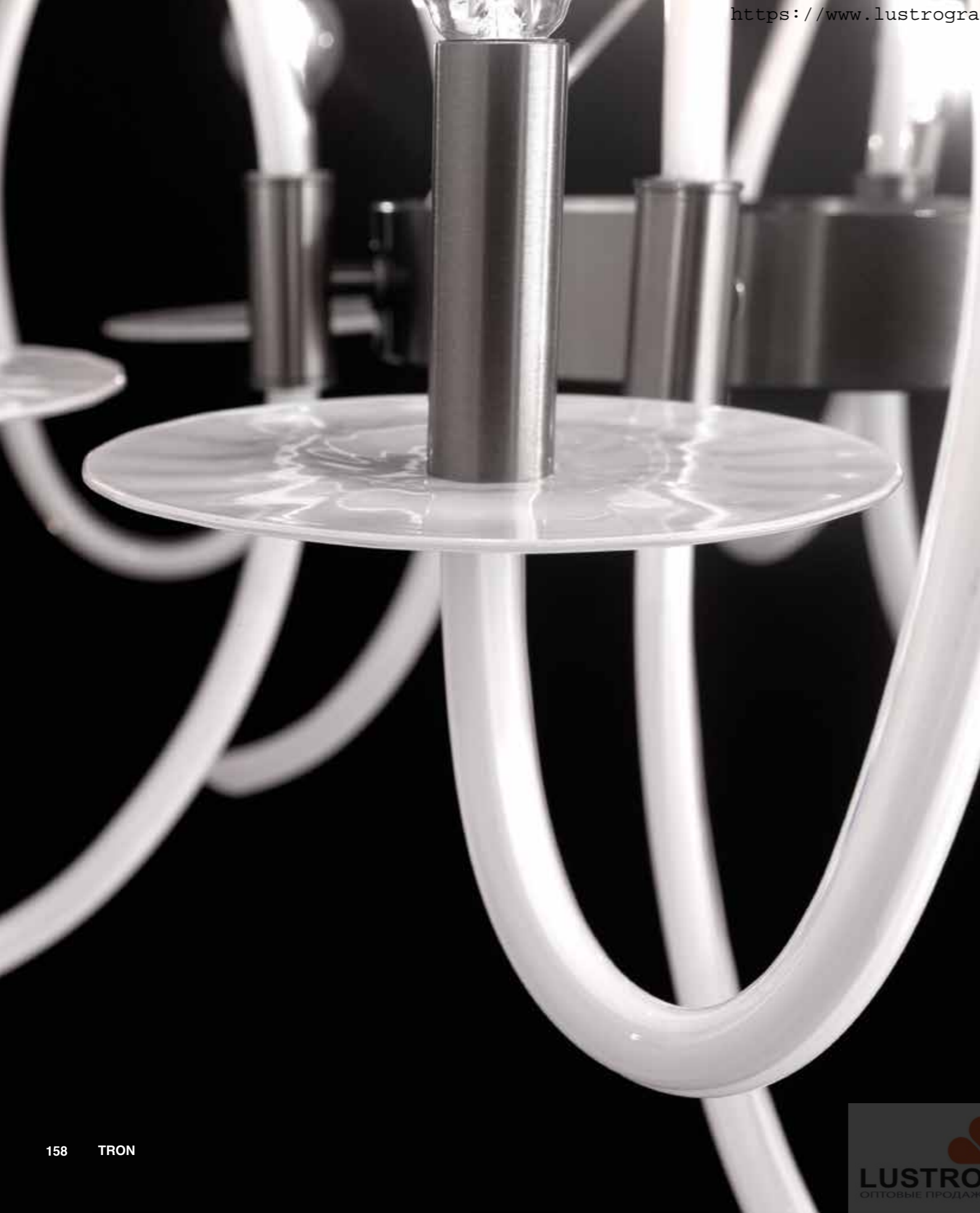





TRON

Misure in cm / Measures in cm

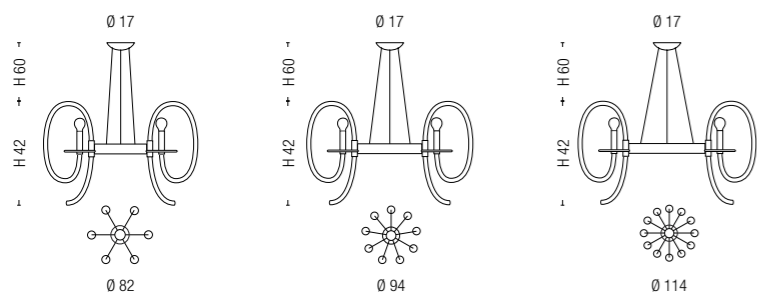

2050/6

CE 6 x max 42W E14

2050/9

CE 9 x max 42W E14

2050/12

CE 12 x max 42W E14

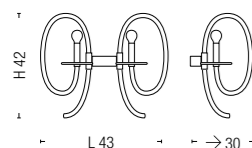

2052/A2

CE 2 x max 42W E14

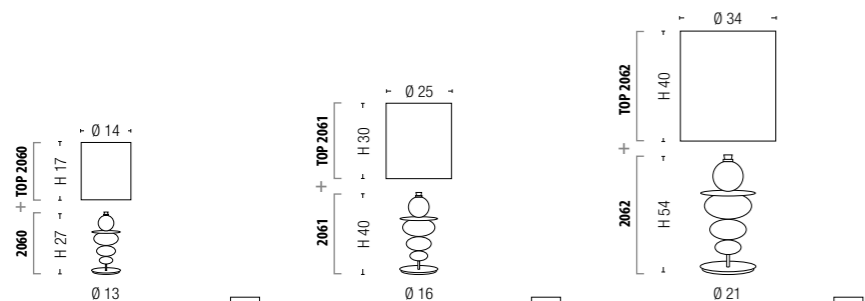

2060 + TOP 2060

CE 1 x max 42W E14

2061 + TOP 2061

CE 1 x max 70W E27

2062 + TOP 2062

CE 1 x max 70W E27

FINITURA METALLO / METAL FINISHES / FINITIONS MÉTAL / METALL-FINISH / ACABADOS EN METAL / ОТДЕЛКА МЕТАЛЛОМ



NNS

Nichel nero spazzolato
Brushed Black Nickel
Nickel Noir Brossé
Schwarz Buersten Nickel
Niquel Negro Cepillado
Матовый черный никель

FINITURA VETRO / GLASS FINISHES / FINITION VERRE / GLAS-FINISH / ACABADO VIDRIO / ОТДЕЛКА СТЕКЛОМ

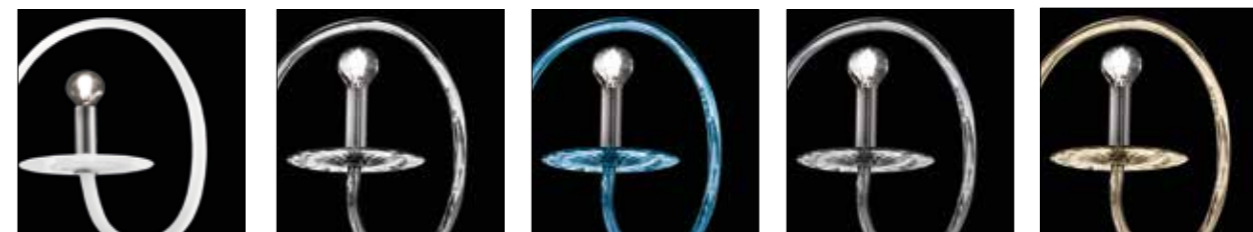

BL

Bianco Latte Cristallo
Milk White Clear
Blanc Lait Cristal
Milchweiß Kristall Blanco
Leche Cristal
Молочно-белый
Хрусталь

CR

Cristallo / Clear / Cristal
Kristallglas / Cristal
Хрусталь

DEN

Denim / Blue Denim / Bleu
Denim / Blau Denim / Azul
Denim / Джинсовый

GRY

Grigio / Grey / Gris / Grau
Gris / Серое

TOP

Topazio / Topaz / Topaze
Topas / Топаз / топазовый



CAN CAN

Design
Andrea Lazzari











CAN CAN

Misure in cm / Measures in cm

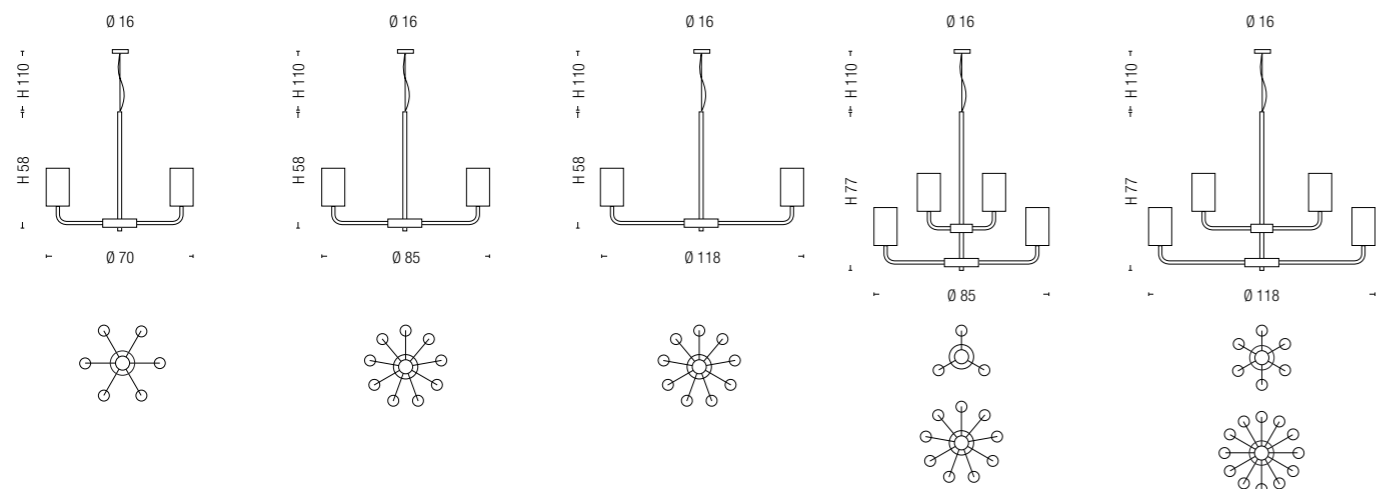

2120/6

CE 6 x max 42W E14

2120/9

CE 9 x max 42W E14

2120/12

CE 12 x max 42W E14

2120/9+3

CE 12 x max 42W E14

2120/12+6

CE 18 x max 42W E14

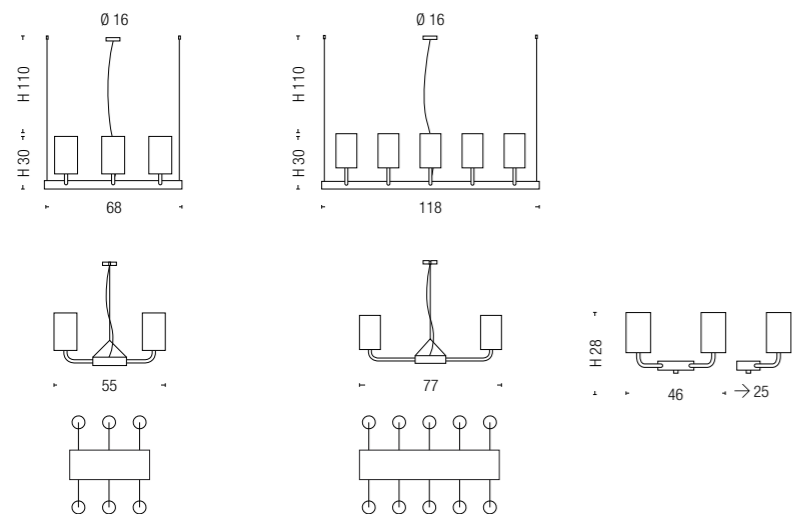

2121/6

CE 6 x max 42W E14

2121/10

CE 10 x max 42W E14

2122/A2

CE 2 x max 42W E14

FINITURA METALLO / METAL FINISHES / FINITIONS MÉTAL / METALL-FINISH / ACABADOS EN METAL / ОТДЕЛКА МЕТАЛЛОМ



K
Cromo lucido / Polish chrome / Chrome brillant
Glaenzend Chrom / Cromo brillante / Хром

FINITURA VETRO / GLASS FINISHES / FINITION VERRE / GLAS-FINISH / ACABADO VIDRIO / ОТДЕЛКА СТЕКЛОМ



BL
Bianco Latte Cristallo
Milk White Clear
Blanc Lait Cristal
Milchweiß Kristall Blanco
Leche Cristal
Молочно-белый
Хрусталь

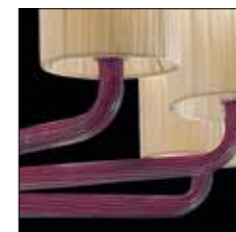

BL.AMT
Bianco Latte Ametista
Milky White Amethyst
Blanc Lait Améthyste
Milchiges Amethystviolett
Blanco Leche Ametista
Молочно-белый аметистовый



BL.AV
Bianco Latte - Avorio
Milk White and Ivory
Blanc Lait et Ivoire
Milchweiß und Elfenbein
Blanco Leche y Marfil
Молочно-белый и Слоновая кость

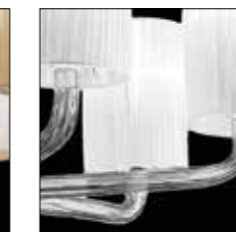

CR.BIA
Cristallo / Clear / Cristal
Kristallglas / Cristal
Хрусталь

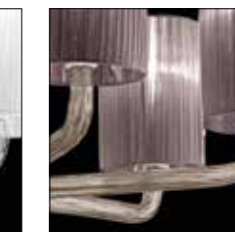

FU
Fumé / Smoked / Fumé
Rauchfarben / Fumé
Дымчатый



STREET

Design
Massimo Tonetto







2062 K FU +
TOP 2062 BIA



2001/9 FU





STREET

Misure in cm / Measures in cm

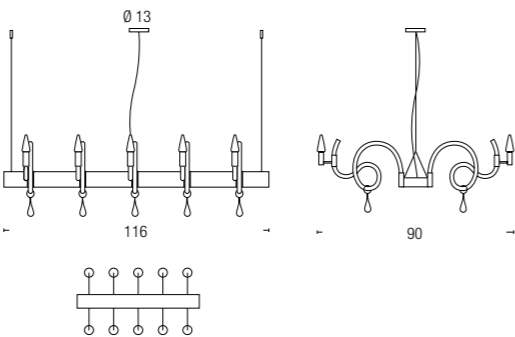
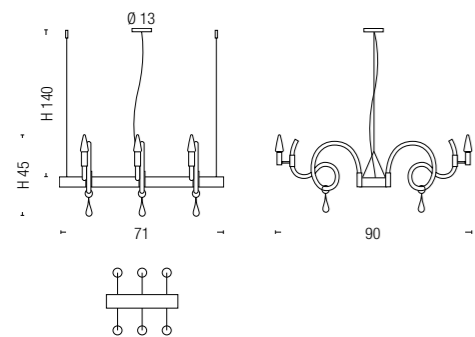

2000/6

CE 6 x max 42W E14

2000/10

CE 10 x max 42W E14

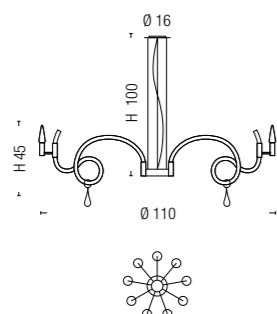
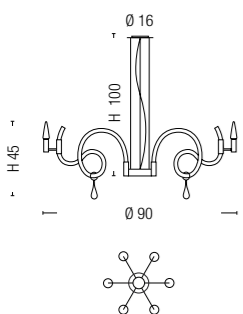

2001/6

CE 6 x max 42W E14

2001/9

CE 9 x max 42W E14

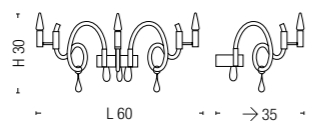
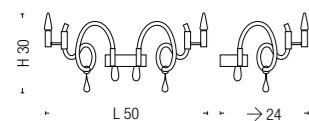

2002/2

CE 2 x max 42W E14

2002/3

CE 3 x max 42W E14

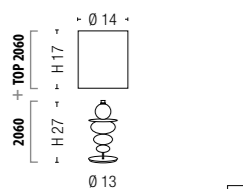

2060 + TOP 2060
CE 1 x max 42W E14

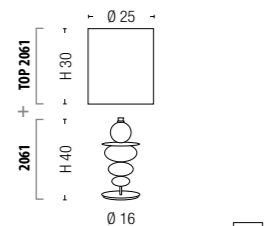

2061 + TOP 2061
CE 1 x max 70W E27

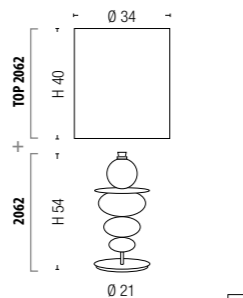

2062 + TOP 2062
CE 1 x max 70W E27

FINITURA METALLO / METAL FINISHES / FINITIONS MÉTAL / METALL-FINISH / ACABADOS EN METAL / ОТДЕЛКА МЕТАЛЛОМ



K
Cromo lucido / Polish chrome / Chrome brillant
Glaenzend Chrom / Cromo brillante / Хром

FINITURA VETRO / GLASS FINISHES / FINITION VERRE / GLAS-FINISH / ACABADO VIDRIO / ОТДЕЛКА СТЕКЛОМ



AS
Ambra Sommerso
Submerged Amber
Ambre Profond
Tauch-Bernstein
Ámbar Sumergido
Янтарь Соммерсо



BL
Bianco Latte Cristallo
Milk White Clear
Blanc Lait Cristal
Milchweiß Kristall Blanco
Leche Cristal
Молочно-белый
Хрусталь



CR
Cristallo / Clear / Cristal
Kristallglas / Cristal
Хрусталь



DEN
Denim / Blue Denim / Bleu
Denim / Blau Denim / Azul
Denim / Джинсовый



FU
Fumé / Smoked / Fumé
Rauchfarben / Fumé
Дымчатый



GRY
Grigio / Grey / Gris / Grau
Gris / Серое



PHOENIX

Design
Sylcom Glass Design

Restyling
Massimo Tonetto



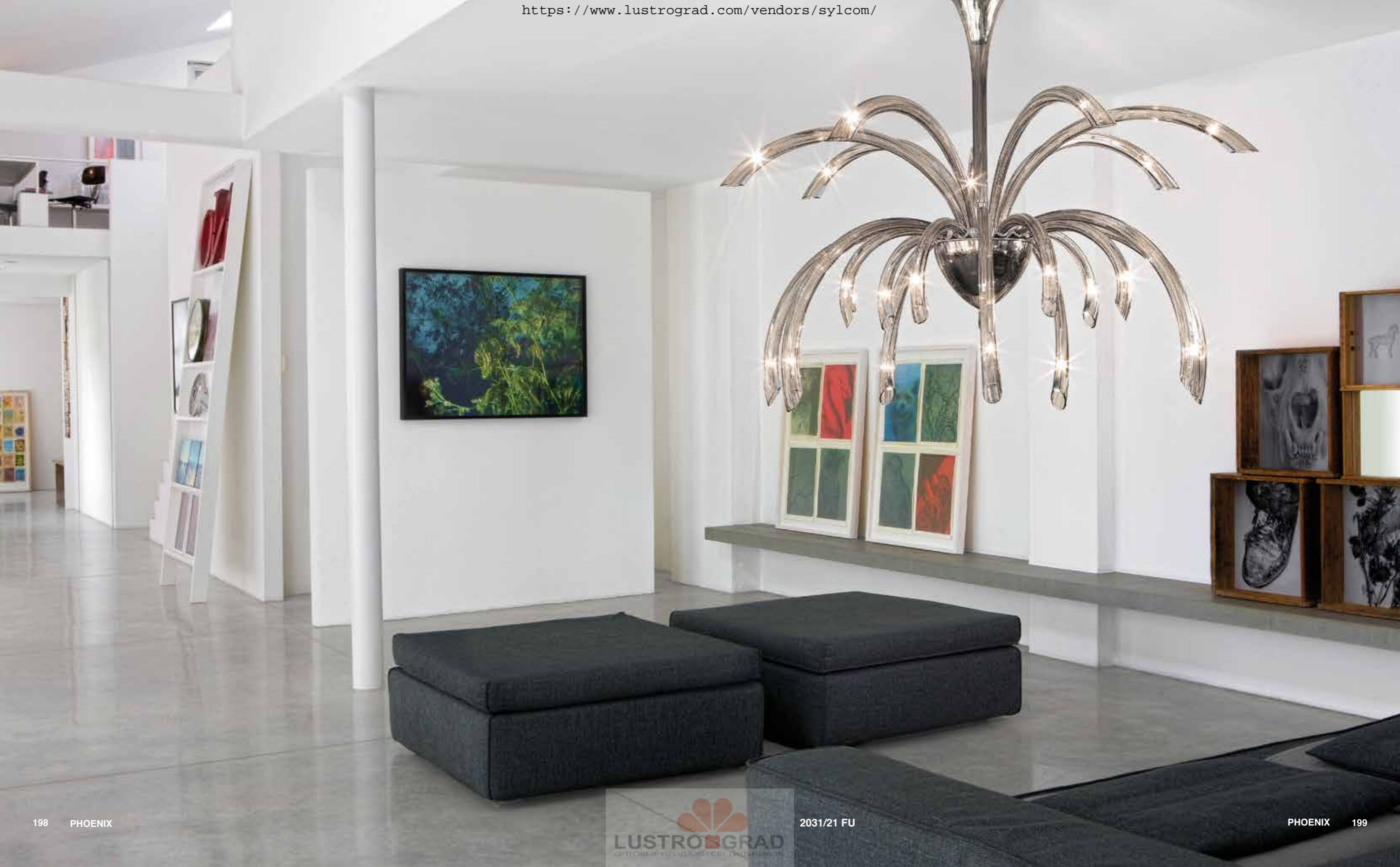



200 PHOENIX

2033/7 FU



2030/15 FU



PHOENIX 201



PHOENIX

Misure in cm / Measures in cm

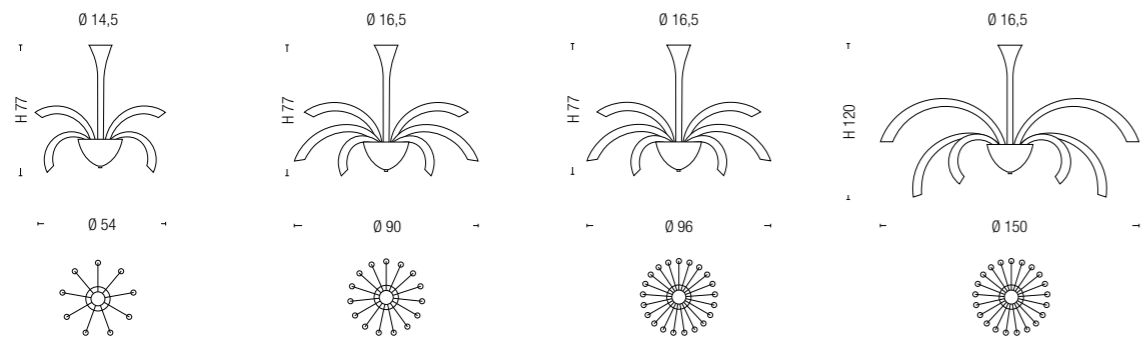

2030/9

CE 9 x max 25W G9

2030/15

CE 15 x max 25W G9

2030/21

CE 21 x max 25W G9

2031/21

CE 21 x max 25W G9

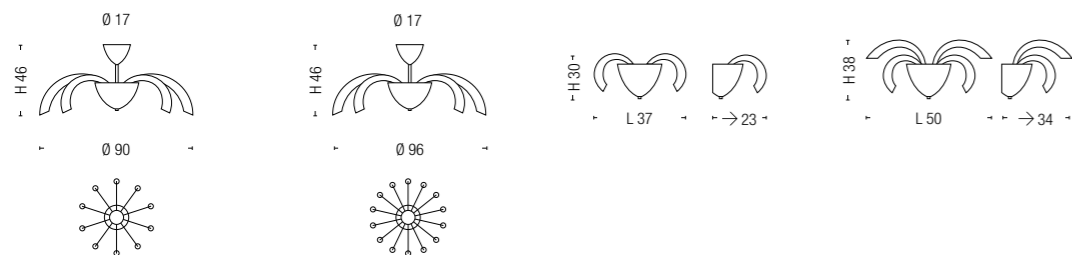

2032/10

CE 10 x max 25W G9

2032/14

CE 14 x max 25W G9

2033/3

CE 3 x max 25W G9

2033/7

CE 7 x max 25W G9

FINITURA METALLO / METAL FINISHES / FINITIONS MÉTAL / METALL-FINISH / ACABADOS EN METAL / ОТДЕЛКА МЕТАЛЛОМ



K

Cromo lucido / Polish chrome / Chrome brillant
Glaenzend Chrom / Cromo brillante / Хром

FINITURA VETRO / GLASS FINISHES / FINITION VERRE / GLAS-FINISH / ACABADO VIDRIO / ОТДЕЛКА СТЕКЛОМ



AS

Ambra Sommerso
Submerged Amber
Ambre Profond
Tauch-Bernstein
Ámbar Sumergido
Янтарь Соммерсо



BL

Bianco Latte Cristallo
Milk White Clear
Blanc Lait Cristal
Milchweiß Kristall Blanco
Leche Cristal
Молочно-белый
Хрусталь



CR

Cristallo / Clear / Cristal
Kristallglas / Cristal
Хрусталь



FU

Fumé / Smoked / Fumé
Rauchfarben / Fumé
Дымчатый

Tutti i nostri apparecchi di illuminazione sono costruiti secondo le norme europee EN 60598 ed internazionali IEC 598 e relative parti seconde e rispondono ai requisiti essenziali delle Direttive Europee vigenti, 2014/35/UE - 2014/30/UE - 2010/30/UE - 2009/125/CE - 2012/19/UE - 2011/65/UE.

Una parte dei nostri prodotti è costruita secondo le norme americane ed è certificata a marchio cULus.

Le descrizioni e le illustrazioni contenute nel catalogo **SYLCOM** devono intendersi a titolo indicativo. **SYLCOM** si riserva il diritto di apportare alla propria collezione, in ogni momento e senza preavviso, eventuali modifiche atte a migliorare il prodotto o in risposta a qualsiasi esigenza di carattere normativo o commerciale, senza comunque variare le caratteristiche essenziali dei singoli modelli.

Tutti i prodotti **SYLCOM** sono garantiti dal marchio che assicura la produzione 100% Made in Italy. La lavorazione manuale di ogni singolo pezzo può comportare piccole differenze nei colori, forme, spessori che non sono da ritenere difetti ma sono una chiara testimonianza della lavorazione autentica dei nostri maestri vetrai.

Il catalogo **SYLCOM** è tutelato dalla legge sui diritti d'autore (legge 22-4-1941 n.633) e dalla legge 14-12-1942 n. 1485: di esso è quindi proibita ogni riproduzione totale o parziale.

All our lighting products have been subjected to construction analysis and testing, in accordance with applicable European standards EN 60598 and international standards IEC 598 and in compliance with updated European standards, 2014/35/UE - 2014/30/UE - 2010/30/UE - 2009/125/CE - 2012/19/UE - 2011/65/UE.

A part of our products has been subjected as well to construction analysis and testing in accordance with the American standards cULus.

Strict accuracy of description and pictures of the products cannot be guaranteed.

Due to product improvement or as a consequence of any manufacturing or commercial requirements **SYLCOM** reserves the right to modify its collection (parts, details, shades of colours), at any time and without prior notice, without however changing the essential characteristics of basic models.

All **SYLCOM** products are protected by the trade-mark, which guarantees they are handmade 100% in Italy. The handmade of each part can create just slight differences in the colours, shapes, thickness that must not be considered deficiency, they are witness of authentic handwork of our glass Masters.

SYLCOM catalogue is covered by Italian and international copyright law, therefore total or partial reproduction is forbidden.

CODICE ITEM	COLLEZIONE COLLECTION	PAGINA PAGE
0010 0011 0012 0013 0014	BITTA	52 61
0030 0031 0036 0037 0038 0039 0040 0041 0046 0047	KORINTHOS	142 155
0080 0081 0082 0085 0086 0087 0088 0089 0090 0092	JUPITER	30 39
0120 0121 0122 0123 0124 0125 0126 0127 0128 0129 0131	MASK	102 119
0140 0141 0142 0143 0144 0145	SWEET	8 17
0190 0191 0192 0193 0194 0195 0198 0199	CHAOTIC	74 87
0200 0201 0202 0203 0204 0205 0206 0207 0211 0212	EMISPHERA	88 101
0220 0221	DIVA	120 129
0240 0241 0242 0243 0244 0245 0246 0247 0248	SPHERA	130 141
0260 0261 0262 0263 0264 0265 0266 0267	CASABLANCA	62 73
0280 0281 0282 0283 0290 0291 0292 0293 0300 0301 0302 0303	APHROS	40 51
2000 2001 2002	STREET	180 193
2030 2031 2032 2033	PHOENIX	194 205
2050 2052	TRON	156 165
2060 2061 2062 2065 2066	IGLOO	18 29
2120 2121 2122	CAN CAN	166 179

100% MADE IN ITALY





Sylcom srl

via Ferraris, 19
30038 Spinea
Venezia ITALY

T +39.041.5411061
F +39.041.999757

info@sylcomsrl.com
direzionesylcom@pec-neispa.com
www.soluzionisylcom.it



© Sylcom srl 02/2017
All rights reserved

AD
Sylcom

Graphic coordination
Studio Pointer

Photographers:
Aldo Sodoma
Intothesign
Quasar

Studio Pointer

Made and printed in Italy
by **Asolana Group**