

Foscarini

**Collezioni —
34 designer, 21
materiali, 48 finiture,
19 tecnologie,
32 colori, 59 famiglie
di lampade,
213 modelli diversi.**

Collezioni — 2017

FOSCARINI

Foscarini è nata da un'intuizione di Carlo Urbinati e Alessandro Vecchiato ed è cresciuta grazie alla passione, all'energia ed al talento di tutti coloro che ci hanno lavorato e ci lavorano.

Foscarini was born from an intuition of Carlo Urbinati and Alessandro Vecchiato and has grown thanks to the passion, energy and talent of all the people that have worked and are working for it.

Collezioni

—
34 designer, 21
materiali, 48
finiture,
19 tecnologie,
32 colori, 59 famiglie
di lampade, 213
modelli diversi.

—
*34 designers, 21
materials, 48
finishes,
19 technologies,
32 colours, 59 lamp
families, 213
different models.*

Company



Collezioni — 2017

005

Foscarini, passionate
about light

Company

Foscarini, passionate about light

Ogni modello Foscarini ha una storia
differente e un carattere speciale, che traduce
un'idea di luce in uno spazio illuminato.
Dietro ad esso ci sono persone che ogni
giorno lavorano con il cuore, la testa, le
mani. Immaginando nuovi modi di accendere
un'atmosfera. Ricercando forme semplici
eppure inconfondibili, nelle quali l'innovazione
tecnologica è sempre presente, senza
ostentazione.

Every Foscarini model has its own
individual story and special personality, to
translate ideas of light into "enlightened"
space. In the background there are people
who work every day with their hearts, heads
and hands, imagining new ways to light up
an atmosphere. Searching for simple yet
unmistakable forms in which technological
innovation is always present but never
conspicuous.



Thoughts take shape

Collezioni — 2017



Innovation happens face-to-face



Ongoing research



Imagine the light

Company



Foscarini for Inventario, Chouchin interpreted by Emmanuel Mathez, Inventario #5



Twice Light Project, Foscarini Spazio Soho, NY, 2015

Collezioni — 2017

Building design culture

Oltre a interpretare il design della luce, Foscarini sostiene la cultura del progetto in ogni sua espressione. Lo fa attraverso il bookzine *Inventario*, fondato, promosso e sostenuto dall'azienda, diretto da Beppe Finessi: uno sguardo sulla scena del design, dell'architettura e dell'arte, completamente indipendente e libero da logiche aziendali, premiato con il Compasso d'Oro ADI. E con installazioni creative e di valore artistico, dal progetto fotografico *Twice Light* a New York alla celebrazione dei 25 anni di *Lumiere* alla Triennale di Milano: un work in progress mai autoreferenziale, sempre stimolante ed emozionante.

Besides interpreting lighting design, Foscarini supports design culture in all its expressive facets. Through the bookzine *Inventario*, founded, sustained and promoted by the company, and directed by Beppe Finessi: a perspective on the design, architecture and art scene, completely independent and free of corporate constraints, winner of the Compasso d'Oro ADI. And with creative and artistic installations, from the *Twice Light* photography project in New York to the celebration of the 25th anniversary of *Lumiere* at the Milan Triennale: work in progress, never self-referential, always stimulating and engaging.

Textes en français, deutsche Texte, textos en español → p. 405



Anni Luce, Lumiere's journey, through 25 Years of history, Triennale di Milano, 2016

Indice generale — *Product's overview*

**Tavolo — Table →
p. 018**



Anisha
Lievore Altherr
Molina
→ p. 020



Behive
Werner Aisslinger
→ p. 022



Binic
Ionna Vautrin
→ p. 026



Birdie
L+R Palomba
→ p. 030



Birdie Metal
L+R Palomba
→ p. 032



Buds
Rodolfo Dordoni
→ p. 036



Caboche
Urquiola + Gerotto,
→ p. 044



Doll
Ionna Vautrin
→ p. 046

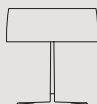

Esa
Lievore Altherr
Molina
→ p. 048



Gregg
L+R Palomba
→ p. 050



Kurage
Nichetto + Nendo
→ p. 052



Lumiere
Rodolfo Dordoni
→ p. 058



Lumiere 25th
Rodolfo Dordoni,
→ p. 064



Lumiere XXL + XXS
Rodolfo Dordoni
→ p. 066



Magneto
Giulio Iacchetti
→ p. 068



Plass media
Luca Nichetto
→ p. 070



Poly Gregg
L+R Palomba
→ p. 072



Rituals
L+R Palomba
→ p. 074

Lampade da tavolo e da terra — *Table and floor lamps*



Rituals XL
L+R Palomba
→ p. 080

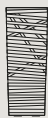

Tress
Marc Sadler
→ p. 082

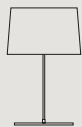

Twiggy XL
Marc Sadler
→ p. 084



Uto
Lagranja Design
→ p. 086



Yoko
Anderssen & Voll
→ p. 090



Aplomb
Lucidi e Pevere
→ p. 094



Birdie
L+R Palomba
→ p. 096



Caboche
Urquiola + Gerotto
→ p. 098

**Terra — Floor →
p. 092**



Colibri
Odoardo Fioravanti
→ p. 100



Giga-Lite
Marc Sadler
→ p. 102



Gregg
L+R Palomba
→ p. 104



Havana
Jozeph Forakis
→ p. 106



Lightwing
Jean Marie Massaud
→ p. 112



Lumiere XXL
Rodolfo Dordoni
→ p. 114



Magneto
Giulio Iacchetti
→ p. 116



Mite
Marc Sadler
→ p. 118



Orbital
Ferruccio Laviani
→ p. 124



Stewie
Luca Nichetto
→ p. 130

Indice generale — Product's overview



Tress
Marc Sadler
→ p. 132



Tress Stilo
Marc Sadler
→ p. 138

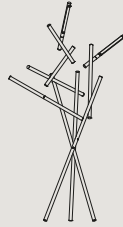

Tuareg
Ferruccio Laviani
→ p. 140

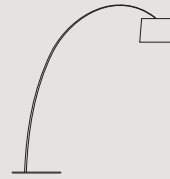

Twiggy
Marc Sadler
→ p. 146

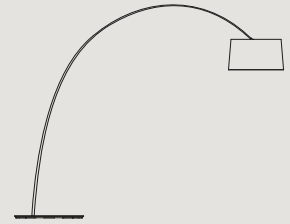

Twice as Twiggy
Marc Sadler
→ p. 152



Twiggy lettura
Marc Sadler
→ p. 156

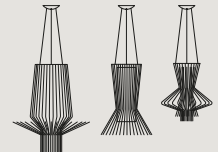

Allegretto
Atelier Oï
→ p. 166

**Sospensione — Suspension →
p. 158**

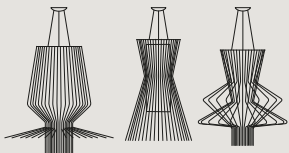

Allegro
Atelier Oï
→ p. 160



Aplomb
Lucidi e Pevere
→ p. 168



Aplomb mini
Lucidi e Pevere
→ p. 172



Aplomb Large
Lucidi e Pevere
→ p. 174



Behve
Werner Aisslinger
→ p. 178

Collezioni — 2017

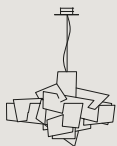

Big Bang
Franzolini + Garcia
Jimenez
→ p. 180

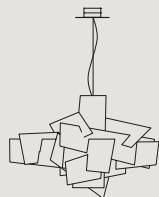

Big Bang L + XL
Franzolini + Garcia
Jimenez
→ p. 186



Birdie
L+R Palomba
→ p. 188

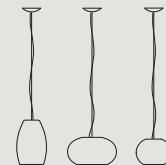

Buds
Rodolfo Dordoni
→ p. 190



**Caboches grande +
media**
Urquiola + Gerotto
→ p. 122

Lampade da terra e da sospensione — *Floor and suspension lamps*



Caboche piccola
Urquiola + Gerotto
→ p. 198



Caiigo
Marco Zito
→ p. 200

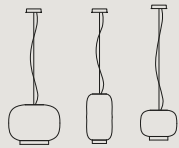

Chouchin
Ionna Vautrin
→ p. 202



Chouchin mini
Ionna Vautrin
→ p. 204

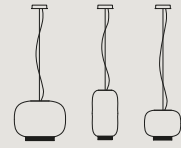

Chouchin Reverse
Ionna Vautrin
→ p. 206



Giga-Lite
Marc Sadler
→ p. 208



Gregg
L+R Palomba
→ p. 210



Havana
Jozeph Forakis
→ p. 212



Jamaica
Marc Sadler
→ p. 214



Le Soleil
Vicente Garcia Jimenez
→ p. 216



Lightweight
Tom Dixon
→ p. 218



Maki
Nendo
→ p. 220



O-space
Nichetto e Gai
→ p. 222



Planet
Changedesign
→ p. 224



Plass grande
Luca Nichetto
→ p. 226



Plass media
Luca Nichetto
→ p. 228

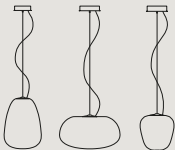

Rituals
L+R Palomba
→ p. 230



Rituals XL
L+R Palomba
→ p. 232



Spokes
Garcia Cumini
→ p. 234



Spokes 2 Large
Garcia Cumini
→ p. 240

Indice generale — *Product's overview*



Supernova
Ferruccio Laviani
→ p. 244



Tartan
L+R Palomba
→ p. 246



Tite
Marc Sadler
→ p. 252



Tress
Marc Sadler
→ p. 254



Tress grande
Marc Sadler
→ p. 256



Tress stilo
Marc Sadler
→ p. 258

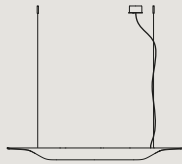

Troag
Luca Nichetto
→ p. 260



Tropico
Giulio Iacchetti
→ p. 264



Twiggy
Marc Sadler
→ p. 266

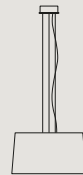

Twice as Twiggy
Marc Sadler
→ p. 268



Uto
Lagranja Design
→ p. 270



Wave
Baruffi & De Santi
→ p. 272

**Accessori — Accessories →
p. 274**



Rosone multiplo tondo
Round multiple canopy
→ p. 276



Rosone multiplo lineare piccolo
Small linear multiple canopy
→ p. 280



Rosone multiplo lineare grande
Large linear multiple canopy
→ p. 284

Kit decentramento
Decentralization kit
→ p. 288

Lampade da sospensione e da soffitto — *Suspension and ceiling lamps*

Soffitto — Ceiling →
p. 290



Bahia
L+R Palomba
→ p. 292



Bahia mini
L+R Palomba
→ p. 292



Big Bang
Franzolini + Garcia
Jimenez
→ p. 294

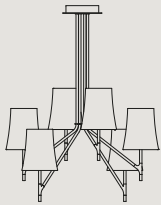

Birdie 3 - 6 - 9
L+R Palomba
→ p. 296



Blob S
Karim Rashid
→ p. 298

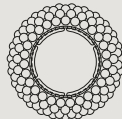

Caboche
Urquiola + Gerotto
→ p. 300



Circus
Defne Koz
→ p. 302

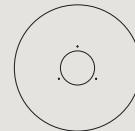

Ellepi
Alessandra Matilde
→ p. 304



Folio
Urbinati + Vecchiato
→ p. 306



Gregg
L+R Palomba
→ p. 308



Lumiere XXL + XXS
Rodolfo Dordoni
→ p. 310

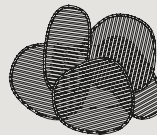

Nuage
Philippe Nigro
→ p. 312



Rituals
L+R Palomba
→ p. 314



Tivu
Jozeph Forakis
→ p. 316



Twiggy
Marc Sadler
→ p. 318



Aplomb
Lucidi e Pevere
→ p. 322

Parete — Wall →
p. 320

Indice generale — *Product's overview*



Bahia
Lucidi e Pevere
→ p. 324



Bahia mini
Lucidi e Pevere
→ p. 328



Big Bang
Franzolini + Garcia
Jimenez
→ p. 330



Birdie
L+R Palomba
→ p. 332

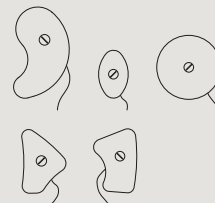

Bit
Ferruccio Laviani
→ p. 334



Blob S
Karim Rashid
→ p. 336



Caboche
Urquiola + Gerotto
→ p. 338



Circus
Defne Koz
→ p. 340



Double
Valerio Bottin
→ p. 342

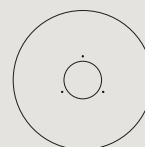

Ellepi
Alessandra Matilde
→ p. 344

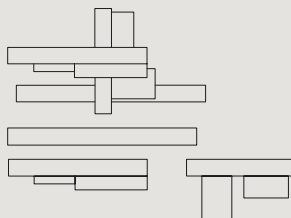

Fields
Vicente Garcia
Jimenez
→ p. 346



Folio
Urbinati + Vecchiato
→ p. 348



Gregg
L+R Palomba
→ p. 350



Havana
Jozeph Forakis
→ p. 352



Innerlight
Simon Pengelly
→ p. 354



Kite
Marc Sadler
→ p. 356



Lake
Lucidi e Pevere
→ p. 358



Le Soleil
Vicente Garcia
Jimenez
→ p. 360



Lumiere XXL + XXS
Rodolfo Dordoni
→ p. 362

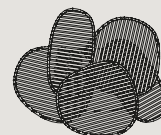

Nuage
Philippe Nigro
→ p. 364

Lampade da parete e da esterno — *Wall and outdoor lamps*

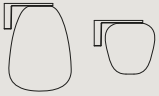

Rituals
L+R Palomba
→ p. 366



Tivu
Jozeph Forakis
→ p. 368



Tress
Marc Sadler
→ p. 370



Tutù
Valerio Bottin
→ p. 372



Gregg Outdoor
sospensione
L+R Palomba
→ p. 376



Gregg Outdoor terra
L+R Palomba
→ p. 378

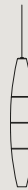

Havana Outdoor
Sospensione
Jozeph Forakis
→ p. 380

**Esterno — *Outdoor* →
p. 374**



Havana Outdoor Terra
Jozeph Forakis
→ p. 382



Solar Outdoor
Jean Marie Massaud
→ p. 386



Uto
Lagranja Design
→ p. 388

Textes en français,
deutsche Texte, textos
en español → p. 390

Legenda — Key
→ p. 406



Tavolo — Table

020 **Anisha**

022 **Behive**

026 **Binic**

030 **Birdie**

032 **Birdie Metal**

036 **Buds**

044 **Caboche**

046 **Doll**

048 **Esa**

050 **Gregg**

052 **Kurage**

058 **Lumiere**

064 **Lumiere 25th**

066 **Lumiere XXL + XXS**

068 **Magneto**

070 **Plass media**

072 **Poly Gregg**

074 **Rituals**

080 **Rituals XL**

082 **Tress**

084 **Twiggy XL**

086 **Uto**

090 **Yoko**



Tavolo, Table



Collezioni — 2017

021

Anisha

Lievore Altherr Molina, 2011

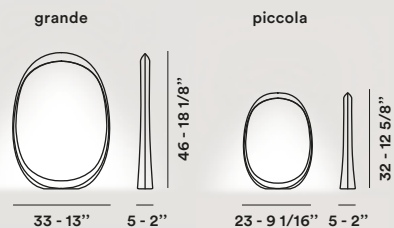

ABS stampato a iniezione.
Injection moulded ABS.

Anisha grande
LED 4,5W 3000° K 400 lm CRI>80
Energy class A+

Anisha piccola
LED 3,4W 3000° K 300 lm CRI>80
Energy class A+

Touch-dimmer integrato
Integrated touch-dimmer



Bianco. *White.*



Tavolo, Table



Collezioni — 2017

023

Behive

Werner Aisslinger, 2011



Tavolo, *Table*



Collezioni — 2017

025

Behive

Werner Aisslinger, 2011

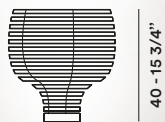

40 - 15 3/4"

39,5 - 15 1/2"

ABS masterizzato, policarbonato
e metallo verniciato.

*Batch-dyed ABS, polycarbonate
and varnished metal.*

220 / 240V: halo o LED retrofit 1x150W E27

120V: halo or LED retrofit 1x150W E26

Energy class A+, A, C

Dimmer incluso — *Dimmer included*



Bianco. *White.*



collection →



p. 178

Tavolo, Table



Collezioni — 2017

Binic

Ionna Vautrin, 2010



Tavolo, Table



Collezioni — 2017

029

Binic

Ionna Vautrin, 2010

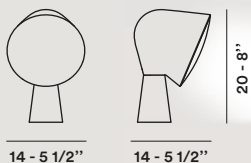

ABS masterizzato e policarbonato.
Polycarbonate and batch-dyed ABS.

220 / 240V: fluo o LED retrofit 1x12W E14
120V: fluo or LED retrofit 1x13W E12
Energy class A+, A

☐ CE IP 20

Bianco, rosa, verde acqua, blu,
giallo, antracite.
*White, pink, turquoise green, blue,
yellow, anthracite.*

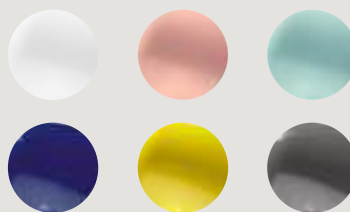

Tavolo, Table



Collezioni — 2017

Birdie

Ludovica + Roberto Palomba, 2011

grande

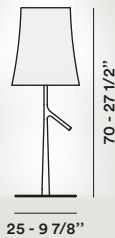

piccola

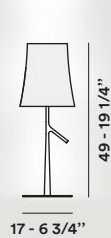

Policarbonato, acciaio e metallo verniciati.
Polycarbonate, varnished steel and metal.

Birdie grande

220 / 240V: halo 1x150W E27,
fluo o LED retrofit 1x25W E27
120V: halo 1x150W E26,
fluo or LED retrofit 1x26W E26
Energy class A+, A, C

Birdie piccola

220 / 240V: halo 1x70W E27,
fluo o LED retrofit 1x20W E27
120V: halo 1x60W E26,
fluo or LED retrofit 1x20W E26
Energy class A+, A, C

On/off o con touch-dimmer integrato
On/off or with integrated touch-dimmer



Bianco, grigio, arancio, amaranth.
White, grey, orange, amaranth.



collection →



p. 032

p. 096

p. 188

p. 296

p. 332

Tavolo, *Table*



Collezioni — 2017

Birdie Metal

Ludovica + Roberto Palomba, 2014



Tavolo, Table



Collezioni — 2017

Birdie Metal

Ludovica + Roberto Palomba, 2014

grande

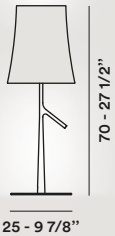

piccola

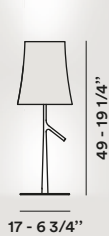

Policarbonato e acciaio metallizzati.
Metallized polycarbonate and metallized steel.

Birdie grande
220 / 240V: fluo o LED retrofit 1x25W E27
120V: fluo or LED retrofit 1x26W E26
Energy class A+, A

Birdie piccola
220 / 240V: fluo o LED retrofit 1x20W E27
120V: fluo or LED retrofit 1x20W E26
Energy class A+, A



Cromo nero, rame.
Black chrome, copper.



collection →

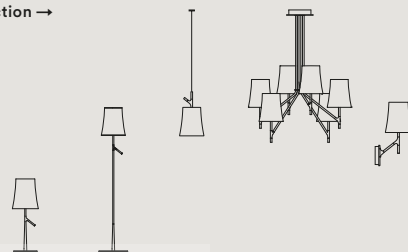

p. 030

p. 096

p. 188

p. 296

p. 332

Stories



Collezioni — 2017

037

Lampada da tavolo e da sospensione — *Table and suspension lamp*

Buds

Rodolfo Dordoni, 2016

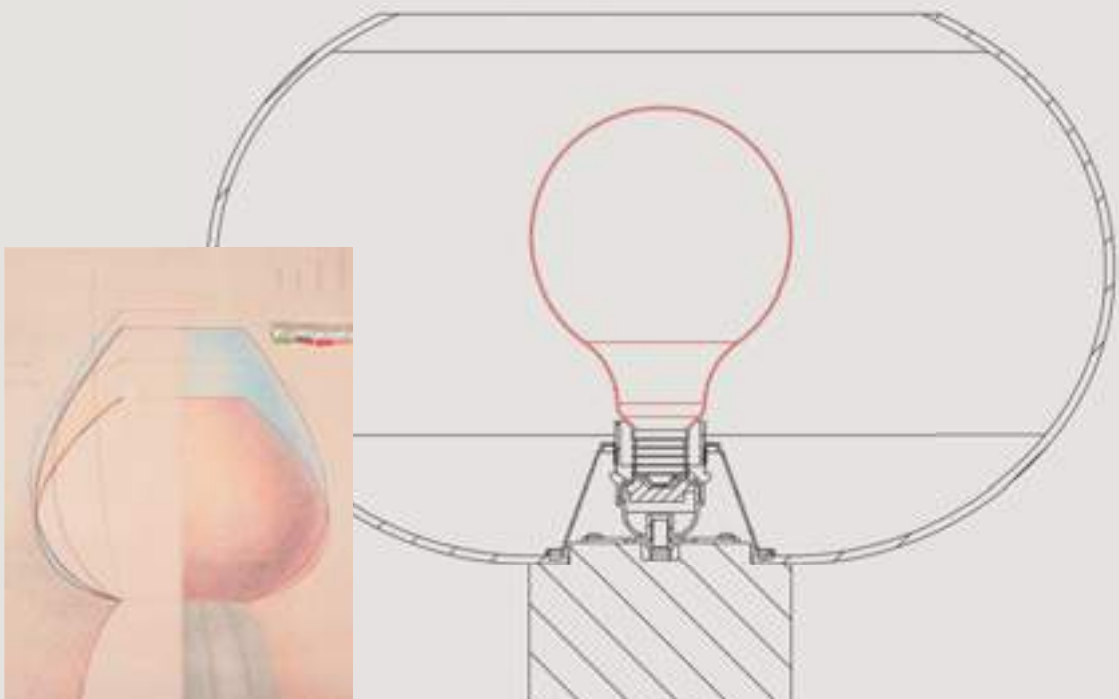

Negli anni 90 Rodolfo Dordoni disegna per Foscarini una collezione di lampade da tavolo, terra e sospensione con diffusori in vetro soffiato dai colori vivaci e nomi che rievocano elementi naturali: Fruits, Blossom e Buds.

In the 1990s, Rodolfo Dordoni designed a collection of table, floor and suspension lamps for Foscarini in brightly coloured blown glass, named after the natural elements: Fruits, Blossom and Buds.

Colourful

Stories



Collezioni — 2017

Buds — Rodolfo Dordoni, 2016

Oggi Buds si rinnova, interpretando il gusto contemporaneo per una raffinata ricchezza e attenzione ai materiali. Protagonista del progetto è come sempre il vetro soffiato, con una lavorazione artigianale a cinque strati, apprezzabile a prima vista grazie al taglio più ampio del diffusore. Con la sua gamma colori – marrone freddo, grigio freddo, verde bambù e bianco caldo, con finitura pagliesco all'interno – Buds assume una doppia valenza: calda quando la lampada è accesa, fredda quando è spenta.

Today, Buds has been restyled, interpreting contemporary taste with a sophisticated wealth and focus on materials. The star of the design remains blown glass, with a five-layer hand-crafted process, which is immediately evident thanks to the larger cut of the diffuser. With its range of colours – cold brown, cold grey, bamboo green and warm white, with a straw-yellow internal finish – Buds takes on a dual value: it is warm when the lamp is on and cold when off.

Textes en français, deutsche Texte, textos en español → p. 395

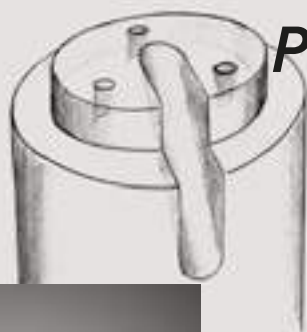

Precious



Tavolo, Table



Collezioni — 2017



Tavolo, Table



Collezioni — 2017

Buds

Rodolfo Dordoni, 2016

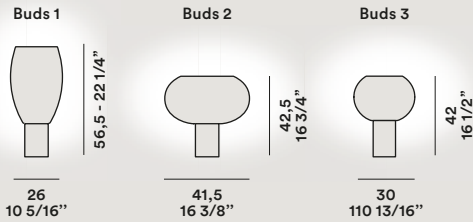

Vetro soffiato e PMMA.
Blown glass and PMMA.

220 / 240V: LED retrofit o fluo
max 1x23W - white globe Ø 9 - 12 cm
120V: LED retrofit or fluo
max 1x23W - type G40 Ø 3 3/4" - 4 3/4"
Energy class A+, A, C



Raccomandata lampadina a globo bianco.
White globe bulb recommended.

Buds 1 marrone, bianco caldo.
Buds 1 brown, warm white.



Buds 2 grigio, bianco caldo.
Buds 2 grey, warm white.



Buds 3 verde bambù, bianco caldo.
Buds 3 bamboo green, warm white.



collection →

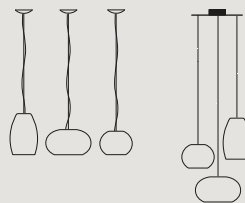

Tavolo, Table



Collezioni — 2017

Caboche

Patricia Urquiola con Eliana Gerotto, 2005

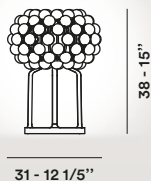

Polimetilmetacrilato, vetro soffiato e alluminio verniciato.

PMMA, blown glass and varnished aluminium.

220 / 240V: halo o LED retrofit 1x48W G9

120V: halo or LED retrofit 1x60W G9

Energy class A+, A, C

220 / 240V: Dimmer incluso — *Dimmer included*

☐ CE IP 20

Trasparente, giallo oro.

Transparent, gold yellow.

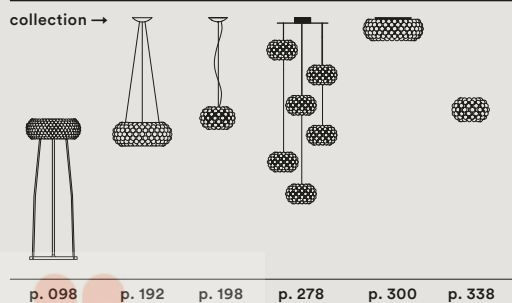
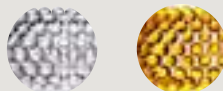

Tavolo, Table



Collezioni — 2017

047

Doll

Ionna Vautrin, 2012



17 - 6 1/2"

Vetro soffiato, ABS masterizzato e policarbonato.

Blown glass, batch-dyed ABS and polycarbonate.

220 / 240V: fluo o LED retrofit 1x12W E14

120V: fluo or LED retrofit 1x13W E12

Energy class A+, A

☐ CE IP 20

Avorio, grigio, verde, rosso.

Ivory, grey, green, red.



LUSTROGRAD

ОПТОВЫЕ ПРОДАЖИ СВЕТИЛЬНИКОВ

Tavolo, Table



Collezioni — 2017

049

Esa

Lievore Altherr Molina, 1996

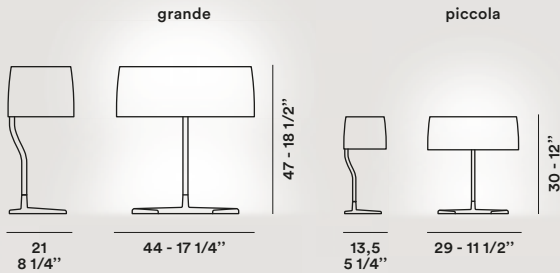

Vetro soffiato e alluminio spazzolato.
Blown glass and polished aluminium.

Esa grande
220 / 240V: halo 1x77W E27,
fluo o LED retrofit 1x20W E27
120V: halo 1x100W E26,
fluo or LED retrofit 1x20W E26
Energy class A+, A, C

Esa piccola
220 / 240V: halo o LED retrofit 1x33W G9
120V: halo 1x40W G9
Energy class A+, A, C

Esa piccola
Dimmer incluso — *Dimmer included*

☐ CE IP 20

Bianco. *White.*



Tavolo, Table



Collezioni — 2017

Gregg

Ludovica + Roberto Palomba, 2007

grande

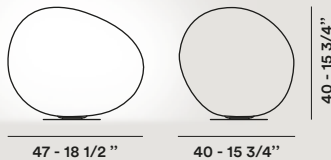

Vetro soffiato acidato e metallo verniciato.
Blown acid-etched glass and varnished metal.

Gregg grande

220 / 240V: halo o LED retrofit 1x205W E27
120V: halo or LED retrofit 1x150W E26
Energy class A+, A, C

media

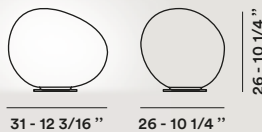

Gregg media

220 / 240V: halo o LED retrofit 1x150W E27
120V: halo or LED retrofit 1x100W E26
Energy class A+, A, C

piccola



Gregg piccola

220 / 240V: halo o LED retrofit 1x20W G9
120V: halo or LED retrofit 1x25W G9
Energy class A+, A, C

On/off o con dimmer incluso
On/off or with dimmer included

☐ CE ⚡ IP 20 © (grande, media)

Bianco. *White.*

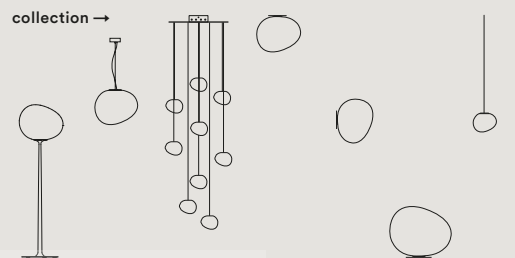

p. 104 p. 210 p. 278 p. 308 p. 350 p. 378 p. 376

Stories



Collezioni — 2017

Lampada da tavolo — *Table lamp*

Kurage

Nichetto + Nendo, 2015



Dalla collaborazione fra il designer italiano Luca Nichetto e il gruppo di lavoro multidisciplinare Nendo, fondato dall'architetto giapponese Oki Sato, nasce un progetto dallo spirito leggero, poetico e artigianale: la lampada da tavolo Kurage.

A lightweight, poetic, handcrafted project has emerged from the joint efforts of Italian designer Luca Nichetto and the multidisciplinary working group Nendo founded by Japanese architect Oki Sato - the new Kurage table lamp.

Poetic lightness

Tavolo, Table



Kurage in giapponese significa medusa ed infatti questa lampada assomiglia a un animale marino che danza leggero, cullato da una luminosità soffusa ottenuta grazie all'utilizzo di pregiata carta washi giapponese. Il diffusore è poi semplicemente appoggiato su una struttura trasparente studiata ad hoc per garantire l'assenza di ombre.

In Japanese kurage means jellyfish and the lamp does in fact resemble a sea animal which dances through the seas cradled by a suffused light, obtained thanks to the use of the finest Japanese washi paper. The diffuser is then simply rested onto a transparent structure designed specifically to ensure it is shadow free.



Refined simplicity



Kurage — Nichetto + Nendo, 2015



Kurage è realizzata grazie ad una particolarissima tecnica di lavorazione sviluppata da AOYA, unico produttore di carta washi tridimensionale, fatta a mano nella città di Tottori in Giappone. Utilizzando fibre dell'albero di gelso si ottiene una carta liscia e porosa al tempo stesso che filtra la luce creando un'atmosfera rilassata, calda ed emozionante, capace di sedurre l'intelletto e il cuore. Completano il progetto quattro sottili gambe in legno di frassino colore naturale, il portalampada in ceramica bianco ed il cavo elettrico ricoperto con una calza in fibra di carta.

Kurage is made thanks to a very particular workmanship technique developed by AOYA, the only manufacturer of 3D washi paper, which is hand-made in the city of Tottori in Japan. Obtained from mulberry tree fibres, washi paper is both smooth and porous and filters the light creating a relaxing, cosy and emotional atmosphere capable of seducing both heart and intellect. Four slender natural coloured ashwood legs finish off the lamp together with a white ceramic lamp holder and an electric cable covered in a paper fibre sock.

Textes en français, deutsche Texte, textos en español → p. 397

Washi paper

Tavolo, *Table*



Collezioni — 2017

057

Kurage

Nichetto + Nendo, 2015

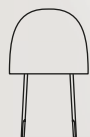

30 - 11 3/4"



34 - 13 1/4"

49 - 19 1/4"

Carta washi e legno di frassino.
Washi paper and ashwood.

220 / 240V: fluo o LED retrofit 1x20W E27

120V: fluo or LED retrofit 1x20W E26

Energy class A+, A

☐ CE IP 20

Bianco. *White.*



LUSTROGRAD
ОПТОВЫЕ ПРОДАЖИ СВЕТИЛЬНИКОВ

Stories



Collezioni — 2017

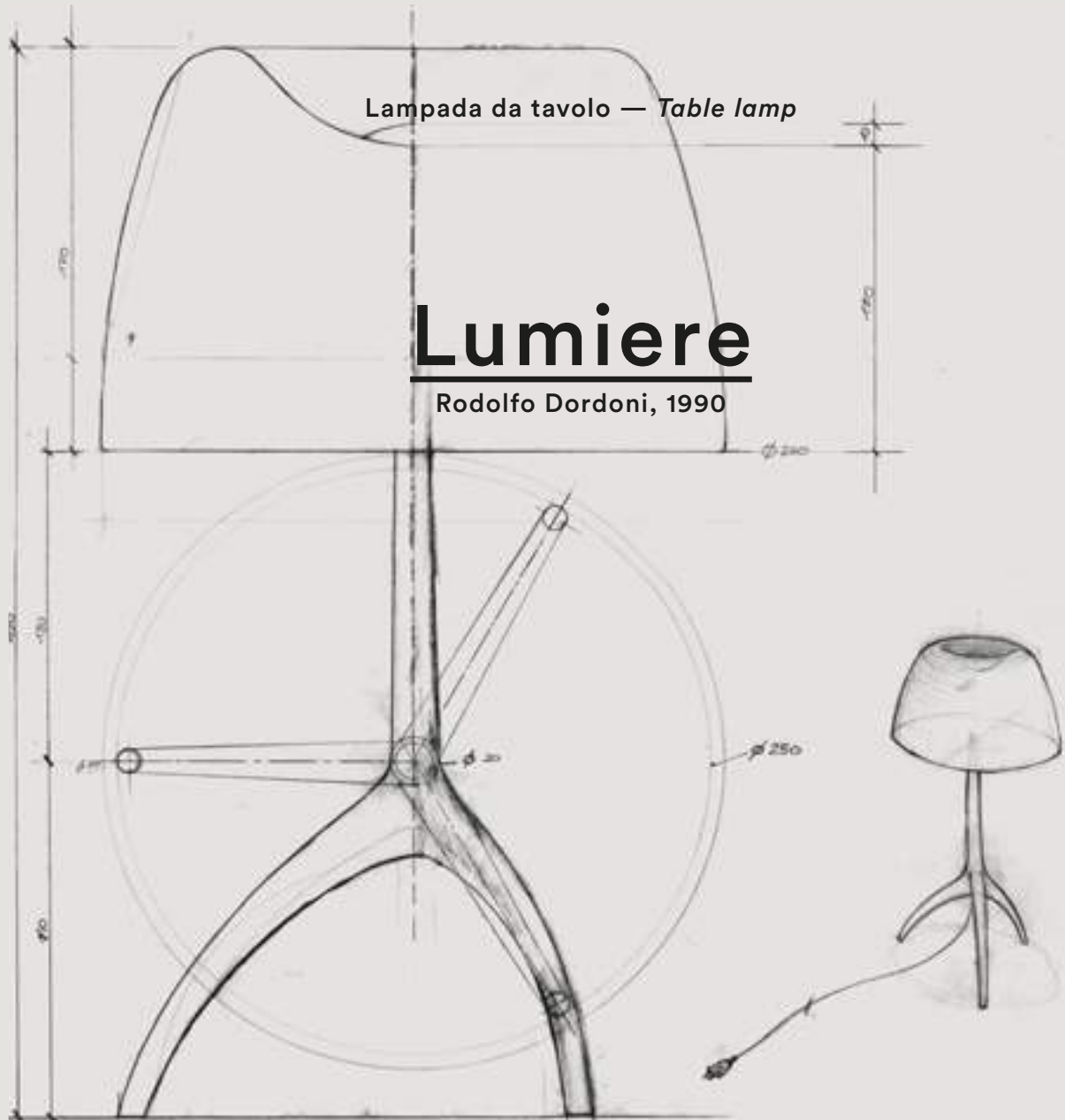

Lumiere, imperdibile best-seller.

L'abat-jour nasce nel XVII secolo a Parigi e da allora, fino ai giorni nostri, ha attraversato innumerevoli interpretazioni. Poi nel 1990, dall'incontro fra un designer e un'azienda italiani, nasce un'idea nuova nel mondo dell'illuminazione: Lumiere.

Lumiere, a must-have best-seller.

The bedside lamp was invented in Paris during the 17th Century and it has undergone a myriad interpretations ever since. In 1990, a meeting between a designer and an Italian company gave rise to a brand new idea in the lighting industry, namely Lumiere.

Best-seller

Stories

Lumiere — Rodolfo Dordoni, 1990

Una rilettura colta e raffinata della classica abat-jour, con un prezioso diffusore in vetro soffiato – disponibile in diverse tonalità e una incamiciatura interna del vetro che rende la luce ancora più morbida e calda – unito a un inconfondibile treppiede in alluminio.

It is a learned and sophisticated restyling of the classic bedside lamp, with a precious blown glass diffuser – available in different colours with a special layer in the inner side of the glass that makes the light it casts even warmer and softer – combined with an unmistakable tripod in die-cast aluminium.

Elegance

Collezioni — 2017





Lumiere ha sempre una storia splendida e diversa da raccontare. Per celebrare il suo 25° anniversario, nasce infatti anche un'edizione speciale, con un trattamento metallizzato del vetro che fa intravedere magicamente la sorgente luminosa all'interno.

Lumiere has always a different yet spectacular tale to tell. To celebrate the 25th anniversary of its creation, Lumiere is proposed in a special edition, with a metallic treatment of the glass that lets you catch a glimpse of the light source inside.

Textes en français, Deutsche Texte, Textos en español → p. 398

25th Anniversary

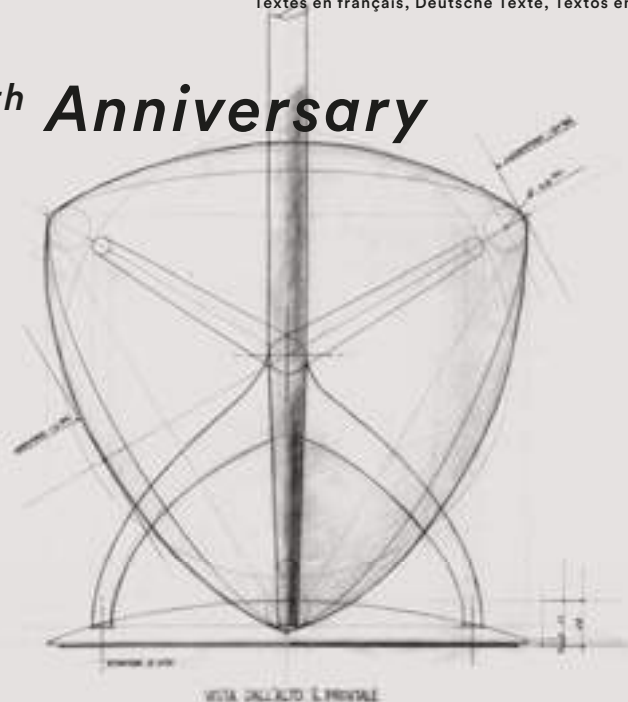

Tavolo, Table



Collezioni — 2017

063

Lumiere

Rodolfo Dordoni, 1990

grande

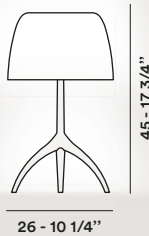

piccola



Vetro soffiato e alluminio spazzolato o verniciato.

Blown glass and polished or varnished aluminium.

Lumiere grande

220 / 240V: halo o LED retrofit 2x48W G9

120V: halo or LED retrofit 2x40W G9

Energy class A+, A, C

Lumiere piccola

220 / 240V: halo o LED retrofit 1x48W G9

120V: halo or LED retrofit 1x40W G9

Energy class A+, A, C

220/240V:

On/off o con dimmer incluso

On/off or with dimmer included



Vetro: bianco, bianco caldo, ciliegia, turchese.

Glass: white, warm white, cherry, turquoise.

Montatura: alluminio spazzolato, cromo nero, champagne.

Frame: polished aluminium, black chrome, champagne.

on →

off →

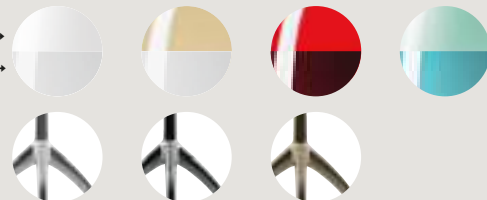

collection →



p. 064

Tavolo, Table



Collezioni — 2017

065

Lumiere 25th

Rodolfo Dordoni, 1990/2015

grande



piccola



Vetro soffiato e specchiato e alluminio spazzolato o verniciato.
Blown mirrored glass and polished or varnished aluminium.

Lumiere 25th grande
220 / 240V: halo o LED retrofit 2x48W G9
120V: halo or LED retrofit 2x40W G9
Energy class A+, A, C

Lumiere 25th piccola
220 / 240V: halo o LED retrofit 1x42W G9
120V: halo or LED retrofit 1x40W G9
Energy class A+, A, C

220/240V
On/off o con dimmer incluso
On/off or with dimmer included



Vetro: specchio trasparente.
Glass: transparent mirror.
Montatura: alluminio spazzolato, cromo nero, champagne.
Frame: polished aluminium, black chrome, champagne.



collection →



p. 058

Tavolo, Table



Collezioni — 2017

Lumiere XXL + XXS

Rodolfo Dordoni, 2009

Lumiere XXL



Lumiere XXS



Vetro soffiato e alluminio spazzolato o verniciato.

Blown glass and polished or varnished aluminium.

Lumiere XXL

220 / 240V: halo o LED retrofit 4x33W G9
120V: halo 4x40W G9

Lumiere XXS

220 / 240V: halo o LED retrofit 1x48W G9
120V: halo 1x40W G9

Energy class A+, A, C

Dimmer incluso — *Dimmer included*

☐ CE  IP 20

Vetro: bianco, grigio freddo, marrone freddo.

Glass: white, cool grey, cool brown.

Montatura: alluminio, cromo nero.

Frame: aluminium, black chrome.

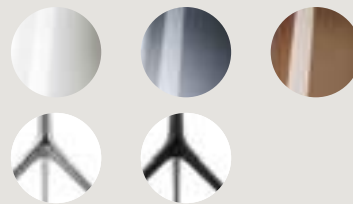

collection →



p. 114

p. 310

p. 362

Tavolo, Table



Collezioni — 2017

Magneto

Giulio Iacchetti, 2011

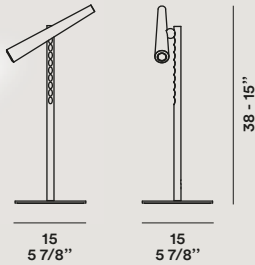

Acciaio verniciato opaco, ABS e supermagnete in terre rare.

Matt varnished steel, ABS and super magnet made of "rare earth".

LED 5W 2700° K 475 lm CRI>80

Energy class A+



Bianco, nero.

White, black.



collection →



p. 116

Tavolo, Table



Collezioni — 2017

071

Plass media

Luca Nichetto, 2015

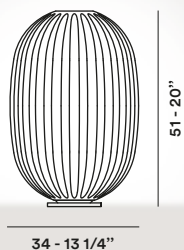

Policarbonato stampato in rotazionale e acciaio.

Rotational moulded polycarbonate and steel.

220 / 240V: halo o LED retrofit 1x150W E27,
120V: halo or LED retrofit 1x150W E26,
Energy class A+, A, C

On/off o con dimmer incluso
On/off or with dimmer included

☐ CE  IP 20

Azzurro, grigio.
Light blue, grey.

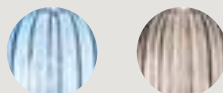

collection →

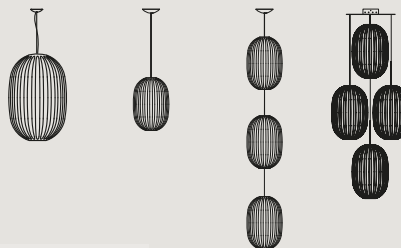

p. 226

p. 228

p. 228

p. 284

Tavolo, Table



Collezioni — 2017

Poly Gregg

Ludovica + Roberto Palomba, 2011

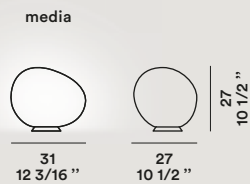
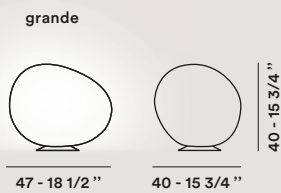
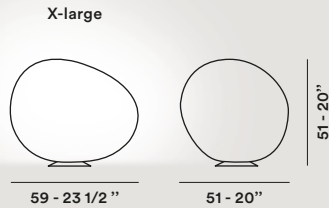

Polietilene stampato in rotazionale.
Rotational moulded polyethylene.

Poly Gregg X-large - grande
220 / 240V: fluo o LED retrofit 1x25W E27
120V: fluo or LED retrofit 1x26W E26
Energy class A+, A

Poly Gregg media
220 / 240V: fluo o LED retrofit 1x15W E27
120V: fluo or LED retrofit 1x15W E26
Energy class A+, A

☐ CE IP 20

Bianco. *White.*

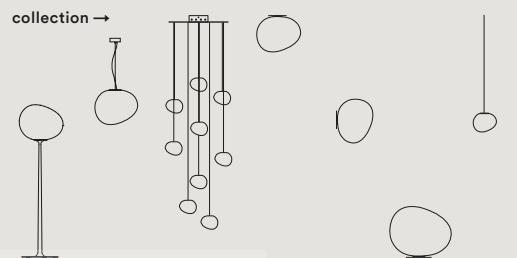

p. 104 p. 210 p. 278 p. 308 p. 35 p. 378 p. 376

Stories



Collezioni — 2017

075

Lampada da tavolo, sospensione, parete e soffitto — *Table, suspension, wall and ceiling lamp*

Rituals

Ludovica + Roberto Palomba, 2013

Rituals, lanterne moderne. Ispirate nella forma alle leggere lanterne di carta di riso della cultura orientale, ma realizzate in prezioso vetro soffiato, materiale di millenaria tradizione occidentale, le lampade Rituals parlano un linguaggio senza tempo e senza confini: quello della bellezza, della poeticità e della libertà d'abbinamento e ambientazione.

Rituals, modern lanterns. Inspired by the shape of light-weight rice paper lanterns from the Oriental culture, yet made in precious blown glass, a material with a thousand-year Western tradition. The Rituals lamps speak a timeless language without boundaries: the language of beauty, poetry, and freedom of combination and setting.

Magical



Stories



Le loro forme, diverse ma complementari, generano una famiglia completa e consentono di dare vita a molteplici composizioni, spaziando fra modelli a sospensione e da tavolo, parete, soffitto, con in più la possibilità di comporre fino a 9 sospensioni grazie al rosone multiplo.

The shapes, which are different yet complementary, generate a complete family and make it possible to put together multiple compositions, ranging from the suspension and table models, to the wall and ceiling versions, with the additional possibility of composing up to 9 suspensions thanks to the multiple canopy.

Versatile



Rituals — Ludovica + Roberto Palomba, 2013



La loro superficie, percorsa da sottili incisioni che ricordano al tempo stesso l'increspatura della carta e la molatura del vetro, diffonde una luce soffusa, intima e carezzevole, ideale per accompagnare i molteplici riti dell'abitare contemporaneo.

The surface, covered with thin engravings that remind of both ruffled paper and glass grinding, diffuses an intimate and caressing light which is ideal for different habits of contemporary living.

Textes en français, Deutsche Texte, Textos en español → p. 400

Craftsmanship

Tavolo, *Table*



Collezioni — 2017

Rituals

Ludovica + Roberto Palomba, 2013

Rituals 1



Rituals 2



Rituals 3



Vetro soffiato satinato inciso e metallo verniciato.
Blown engraved satin glass and varnished metal.

220 / 240V: fluo o LED retrofit 1x15W E27,
halo 1x105W E27,
120V: fluo or LED retrofit 1x15W E26,
halo 1x100W E26,
Energy class A+, A, C

On/off o con dimmer incluso
On/off or with dimmer included

☐ CE  IP 20

Bianco. *White.*



collection →

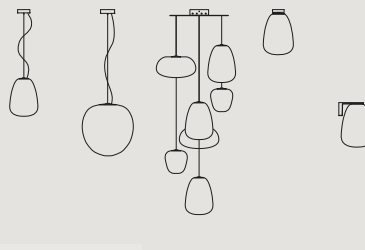

p. 080

p. 230

p. 232

p. 283

p. 314

p. 366

Tavolo, *Table*



Collezioni — 2017

Rituals XL

Ludovica + Roberto Palomba, 2015

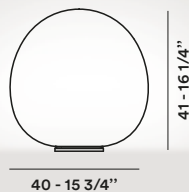

Vetro soffiato satinato inciso e metallo verniciato.

Blown engraved satin glass and varnished metal.

220 / 240V: halo o LED retrofit 1x150W E27,
120V: halo or LED retrofit 1x150W E26,
Energy class A+, A, C

On/off o con dimmer incluso
On/off or with dimmer included

☐ CE  IP 20

Bianco. *White.*



collection →

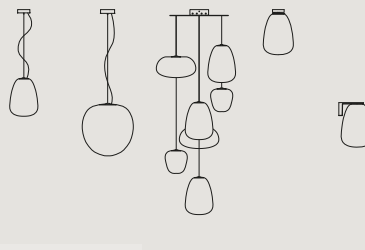

p. 074

p. 230

p. 232

p. 283

p. 314

p. 366

Tavolo, Table



Collezioni — 2017

Tress

Marc Sadler, 2009

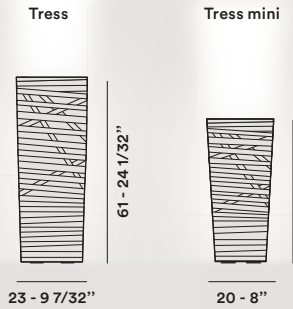

Materiale composito su base di fibra di vetro verniciato.
Varnished fibreglass based composite material.

Tress
220 / 240V: halo o LED retrofit 1x100W E27 PAR
120V: halo or LED retrofit 1x75W E26 PAR

Tress mini
220 / 240V: halo o LED retrofit 1x75W GU10
120V: halo or LED retrofit 1x75W GU10

Energy class A+, A, C

Dimmer incluso — *Dimmer included*

☐ CE IP 20

Bianco, nero, cremisi, greige, indaco.
White, black, crimson, greige, indigo.

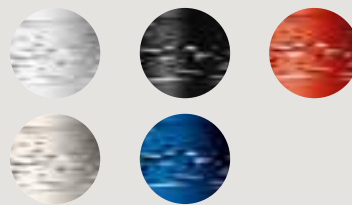

collection →

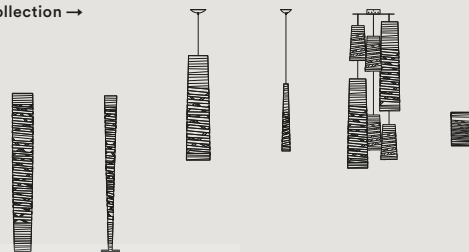

p. 132

p. 138

p. 254-256

p. 258

p. 279

p. 370

Tavolo, Table



Collezioni — 2017

085

Twiggy XL

Marc Sadler, 2008

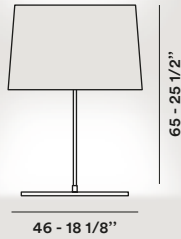

Materiale composito su base di fibra di vetro laccato, policarbonato e metallo verniciato.
Coated fibreglass based composite material, polycarbonate and varnished metal.

220 / 240V: halo o LED retrofit 3x77W E27
120V: inc or LED retrofit 3x100W E26
Energy class A+, A, C

Dimmer incluso — *Dimmer included*

☐ CE IP 20

Bianco, nero.
White, black.



collection →

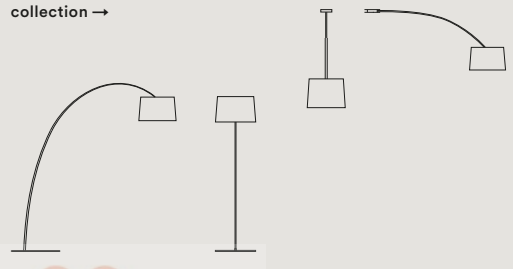

p. 146

p. 156

p. 266

p. 318

Tavolo, Table



Collezioni — 2017

Uto

Lagranja Design, 2005



Tavolo, Table



Collezioni — 2017

089

Uto

Lagranja Design, 2005

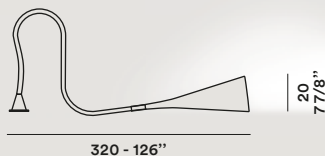

Elastomero termoplastico e policarbonato.
Thermoplastic elastomer and polycarbonate.

220 / 240V: fluo o LED retrofit 1x15W E27

120V: fluo or LED retrofit 1x13W E26

Energy class A+, A

☐ CE  IP 44

Suitable for damp location

Bianco, giallo, arancio.

White, yellow, orange.



collection →

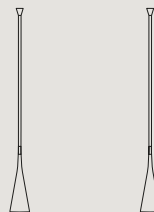

p. 270

p. 388

Tavolo, Table



Collezioni — 2017

091

Yoko

Anderssen & Voll, 2013

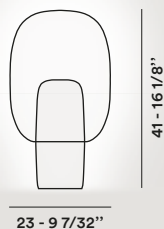

PMMA e policarbonato.
PMMA and polycarbonate.

220 / 240V: fluo o LED retrofit 1x25W E27
120V: fluo or LED retrofit 1x26W E26
Energy class A+, A

☐ CE  IP 20

Verde, arancio, viola.
Green, orange, violet.

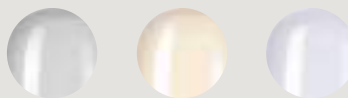



Terra — *Floor*

094	Aplomb	124	Orbital
096	Birdie	130	Stewie
098	Caboche	132	Tress
100	Colibrì	138	Tress Stilo
102	Giga-Lite	140	Tuareg
104	Gregg	146	Twiggy
106	Havana	152	Twice as Twiggy
112	Lightwing	156	Twiggy <i>lettura</i>
114	Lumiere XXL		
116	Magneto		
118	Mite		



Terra, Floor



Collezioni — 2017

Aplomb

Lucidi e Pevere, 2013

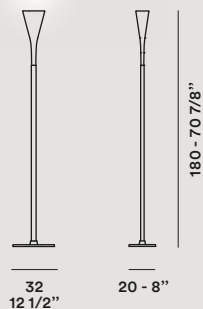

Cemento e metallo verniciato.
Concrete and varnished metal.

220 / 240V: halo o LED retrofit 1x120W R7s
120V: halo 1x150W RSC
Energy class A+, A, C

Dimmer incluso — *Dimmer included*

☐ CE  IP 20

Bianco, grigio cemento, marrone.
White, concrete grey, brown.

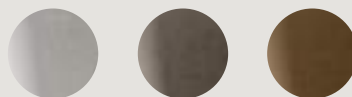

collection →

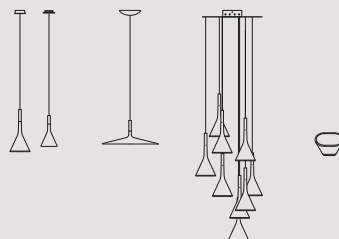

p. 168

p. 174

p. 280

p. 322

Terra, Floor



Collezioni — 2017

Birdie

Ludovica + Roberto Palomba, 2011



Polycarbonato, acciaio e metallo verniciati.
Polycarbonate, varnished steel and metal.

220 / 240V: halo 1x150W E27,
fluo o LED retrofit 1x25W E27
120V: halo 1x150W E26,
fluo or LED retrofit 1x25W E26
Energy class A+, A, C

On/off o con touch-dimmer integrato
On/off or with integrated touch-dimmer



Bianco, grigio, arancio, amaranto.
White, grey, orange, amaranth.



collection →

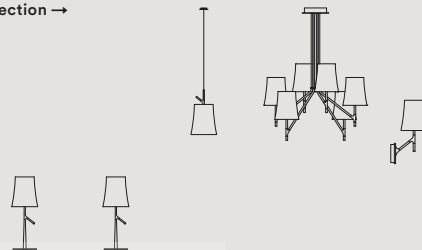

p. 030

p. 032

p. 188

p. 296

p. 332

Terra, Floor



Collezioni — 2017

Caboche

Patricia Urquiola con Eliana Gerotto, 2005

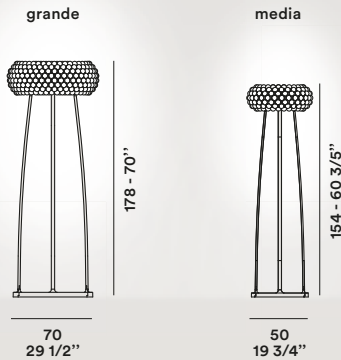

Polimetilmetacrilato, vetro soffiato e metallo verniciato.
Polymethylmethacrylate, blown glass and varnished metal.

grande
220 / 240V: halo o LED retrofit 1x230W R7s
120V: halo or LED retrofit 1x200W RSC
Energy class A+, A, C

media
220 / 240V: halo o LED retrofit 1x160W R7s
halo or LED retrofit 1x150W RSC
Energy class A+, A, C

Dimmer incluso — *Dimmer included*

☐ CE IP 20

Trasparente, giallo oro.
Transparent, gold yellow.

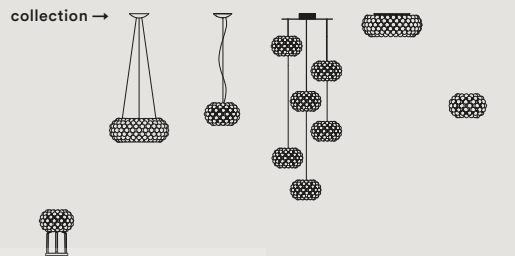
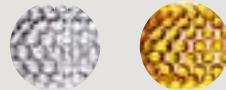

p. 044 p. 192 p. 198 p. 278 p. 300 p. 338

Terra, Floor



Collezioni — 2017

Colibrì

Odoardo Fioravanti, 2011

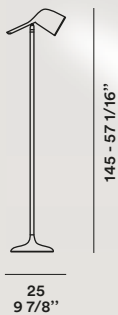

Policarbonato, alluminio e metallo verniciati.
Polycarbonate, varnished aluminium and metal.

220 / 240V: halo o LED retrofit 1x75W GU10 PAR
120V: halo 1x75W GU10 PAR
Energy class A+, A, C

Dimmer incluso — *Dimmer included*

☐ CE IP 20

Bianco. *White.*



Terra, Floor



Collezioni — 2017

Giga-Lite

Marc Sadler, 2004

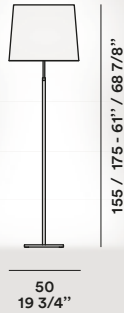

Tessuto di vetro, fibra di carbonio
e acciaio inox. Stelo estensibile.
*Fiberglass fabric, carbonium thread
and stainless steel. Extendable.*

220 / 240V: halo o LED retrofit 3x100W E27
120V: inc 3x150W E26
Energy class A+, A, C

Dimmer incluso — *Dimmer included*

☐ CE IP 20

Nero. *Black.*



collection →

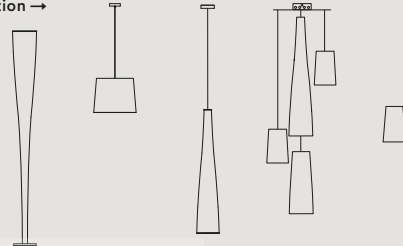

p. 118

p. 208

p. 252

p. 282

p. 356

Terra, Floor



Collezioni — 2017

Gregg

Ludovica + Roberto Palomba, 2010

grande

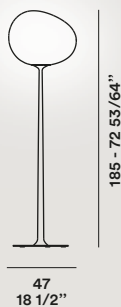

media

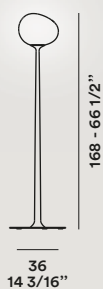

Vetro soffiato acidato, poliuretano verniciato e metallo.

Blown acid-etched glass, varnished polyurethane and metal.

220 / 240V: halo o LED retrofit 1x205W E27

120V: halo 1x150W E26

Energy class A+, A, C

Dimmer incluso — *Dimmer included*

☐ CE IP 20

Bianco. *White.*



collection →

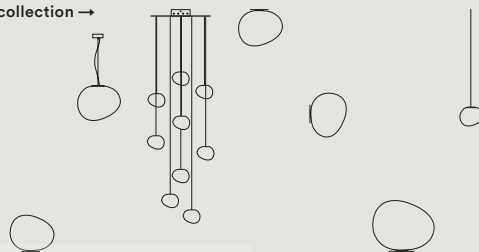

p. 050

p. 210

p. 278

p. 308

p. 350

p. 378

p. 376

Stories

Collezioni — 2017



Lampada da terra, sospensione, parete ed esterno — *Floor, suspension, wall and outdoor lamp*

Havana

Joseph Forakis, 1993

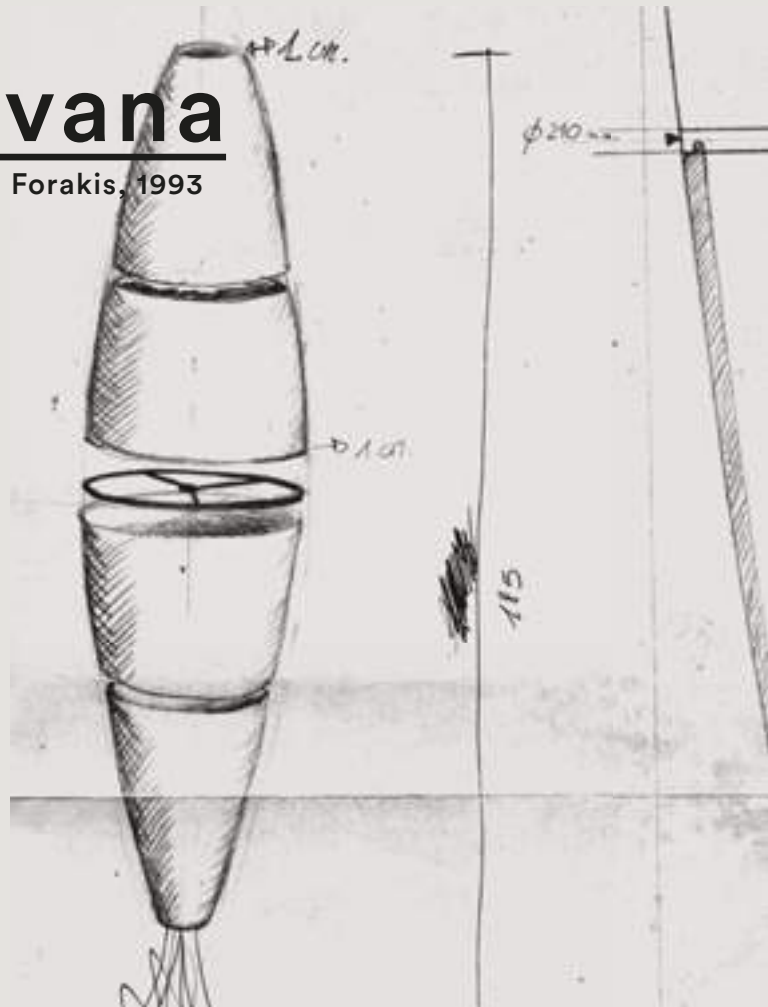

Havana, lampada rivoluzionaria. Vi può capitare di incontrarla dovunque: in un elegante salotto, un locale di tendenza o sul bordo di una piscina. Affusolata come un sigaro, Havana ha uno stile senza età e si trova perfettamente a proprio agio in qualsiasi ambiente, diffondendo attorno a sé una luminosità calda, soffusa e solare.

Havana, a revolutionary lamp. You could happen to see it anywhere: in a stylish living room, trendy eatery or the side of a swimming pool. Tapered like a cigar, Havana has a timeless style which fits perfectly in any environment, diffusing a warm, suffused and sunny light all around.

Stories

Havana — Jozeph Forakis, 1993

È realizzata in polietilene bianco: un materiale leggero, durevole, resistente e riciclabile. È disponibile in versione da terra, da parete e da sospensione, per interni o esterni ed è ambientabile da sola oppure in affascinanti composizioni multiple.

It is made of white polyethylene: a light-weight, durable, hard-wearing and recyclable material. Havana is available in floor, wall and suspension version, for indoor and outdoor use proposed as a stand-alone lamp or in beguiling multiple compositions.

Everywhere

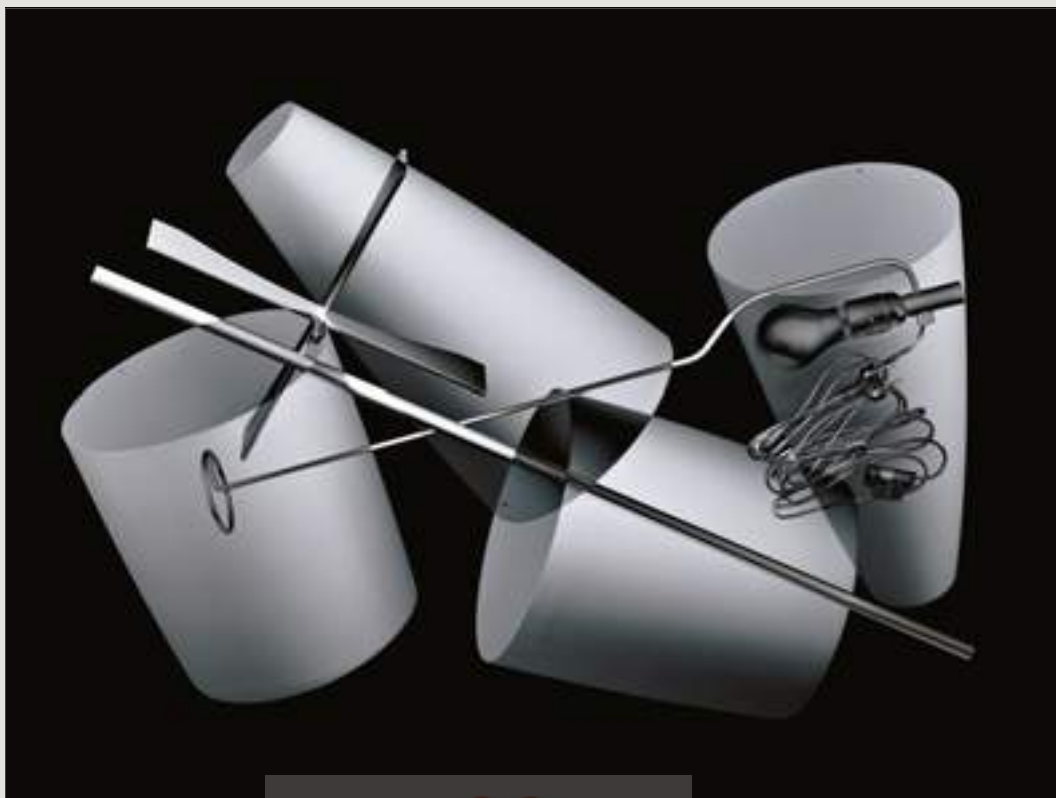



Prototipo — Prototype

Accolta nella collezione permanente del Museum of Modern Art di New York, è uno dei più grandi successi Foscarini: un esempio di come anche il design più raffinato, possa permettersi un piacevole sapore di accessibilità, leggerezza e ironia.

Havana has been honoured to be part of the permanent collection of the New York Museum of Modern Art and it is one of Foscarini's greatest successes: an example of how even the most sophisticated design can afford an enjoyable flair of accessibility, light-weight and irony.

Textes en français, Deutsche Texte, Textos en español → p. 396

Ironic



LUSTROGRAD
ОПТОВЫЕ ПРОДАЖИ СВЕТИЛЬНИКОВ

Terra, Floor



Collezioni — 2017

Havana

Joseph Forakis, 1993

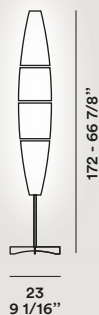

Polietilene stampato ad iniezione
e metallo verniciato.

*Injection moulded polyethylene
and varnished metal.*

220 / 240V: halo 1x116W E27,
fluo o LED retrofit 1x25W E27
120V: inc 1x150W E26,
fluo or LED retrofit 1x26W E26
Energy class A+, A, C

220 / 240V: Dimmer version available



Diffusore: bianco.

Diffusor: white.

Montatura: alluminio, cromo.

Frame: aluminium, chrome.



collection →



p. 212

p. 277

p. 352

p. 382

p. 380

Terra, Floor



Collezioni — 2017

Lightwing

Jean Marie Massaud, 2013

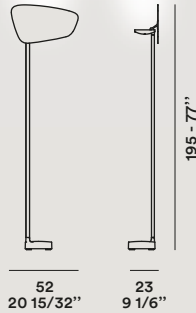

Alluminio verniciato e lega di zinco.
Varnished aluminum and zinc alloy.

220 / 240 V: LED 34W 3000°K 3157 lm CRI>90

120V: 41W 3000°K 3157 lm CRI>90

Energy class A+

Dimmer incluso — *Dimmer included*



Bianco, nero.

White, black.



Terra, Floor



Collezioni — 2017

Lumiere XXL

Rodolfo Dordoni, 2015

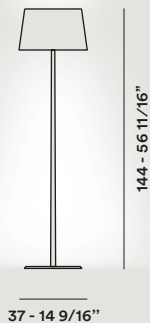

Vetro soffiato e alluminio.
Blown glass and aluminium.

220 / 240V: halo o LED retrofit 4x33W G9
120V: halo 4x40W G9
Energy class A+, A, C

Dimmer incluso — *Dimmer included*

□ CE IP 20

Vetro: bianco, grigio freddo, marrone freddo.
Glass: white, cool grey, cool brown.

Montatura: alluminio, cromo nero.
Frame: aluminium, black chrome.

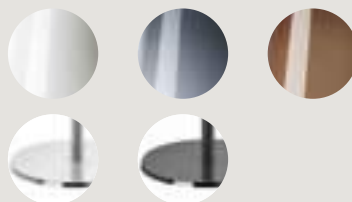

collection →



p. 066

p. 310

p. 362

Terra, Floor



Collezioni — 2017

Magneto

Giulio Iacchetti, 2011

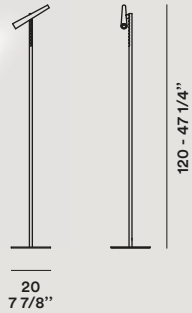

Acciaio verniciato, ABS e supermagnete in terre rare.

Varnished steel, ABS and super magnet made of "rare earth".

LED 5W 2700° K 475 lm CRI>80

Energy class A+



Bianco, Nero.

White, black.



collection →



p. 068

Stories



Collezioni — 2017

Lampada da terra — *Floor lamp*

Mite

Marc Sadler, 2000

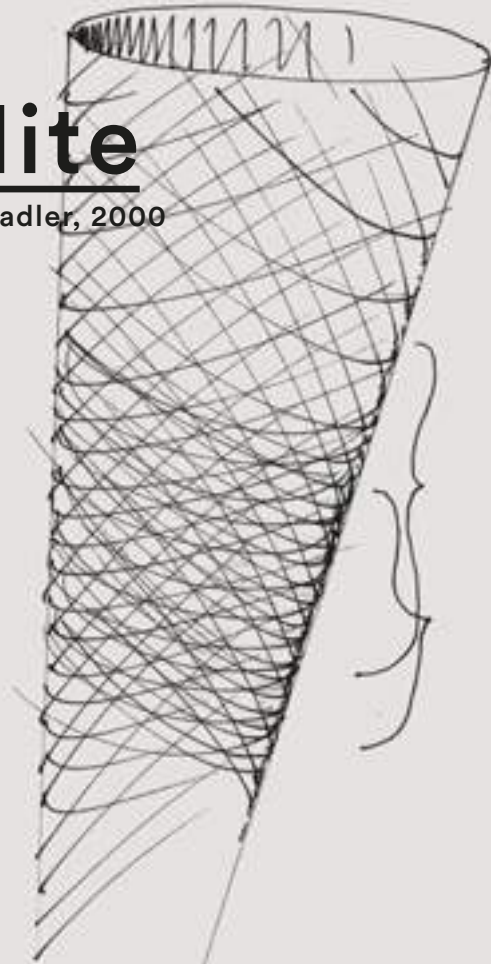

Mite, personalità mitica. Slanciata, elegante, importante, inconfondibile da accesa come da spenta. Una forma sinuosa, vestita con una trama di vetro e filo di carbonio o di Kevlar®, le stesse fibre tecnologiche utilizzate per creare barche a vela e mazze da golf.

Mite, mythical personality. Sleek, sophisticated and important, unmistakable both on and off. A sinuous shape, clad with fiber glass fabric and carbon or Kevlar® yarn, the same high-tech fibres used to build sailing boats and golf clubs.

Stories



Collezioni — 2017



Mite — Marc Sadler, 2000



Un'innovazione assoluta che ha valso a Mite, insieme alla versione a sospensione Tite, il premio Compasso d'Oro ADI, fra i più prestigiosi nel mondo del design. Questa lampada che è diventata un'icona nel panorama dell'illuminazione, nella versione a LED esprime una luminosità ancora più affascinante, con inoltre il vantaggio di una tecnologia amica dell'ambiente.

This absolute innovation earned Mite, together with the Tite suspension version, the ADI Compasso d'Oro, one of the most prestigious design awards in the world. This lamp has become an icon on the lighting scene. In LED version it expresses an even more beguiling luminosity, with the added benefit of an environmentally-friendly technology.

Textes en français, Deutsche Texte, Textos en español → p. 398

Innovation



Compasso D'Oro 2001

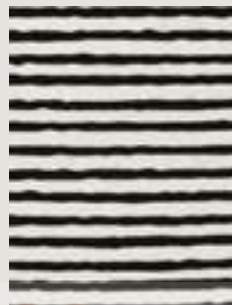

Terra, Floor



Collezioni — 2017

Mite

Marc Sadler, 2000

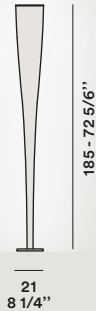

Tessuto di vetro con fibra di carbonio o Kevlar®, metallo nichelato, acciaio e alluminio (LED).

Fiber glass fabric with Kevlar® or carbonium thread, nickel-plated steel and aluminium (LED).

Kevlar® is a Dupont registered trademark.

220 / 240 V: LED 32W 3000°K 2500 lm CRI>90

120V: LED 36W 3000°K 2500 lm CRI>90

Energy class A

220 / 240V: halo o LED retrofit 1x150W E27

120V: inc 1x150W E26

Energy class A+, A, C

Dimmer incluso — *Dimmer included*

☐ CE ⚡ IP 20 — (halo)

Giallo, nero.

Yellow, black.

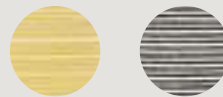

Compasso
D'Oro 2001



collection →

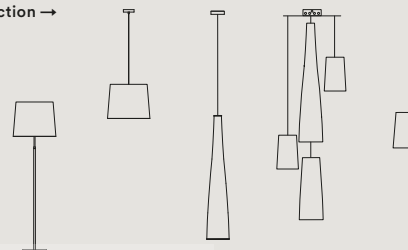

p. 102

p. 208

p. 252

p. 282

p. 356

Stories

Collezioni — 2017



Lampada da terra — Floor lamp

Orbital

Ferruccio Laviani, 1992

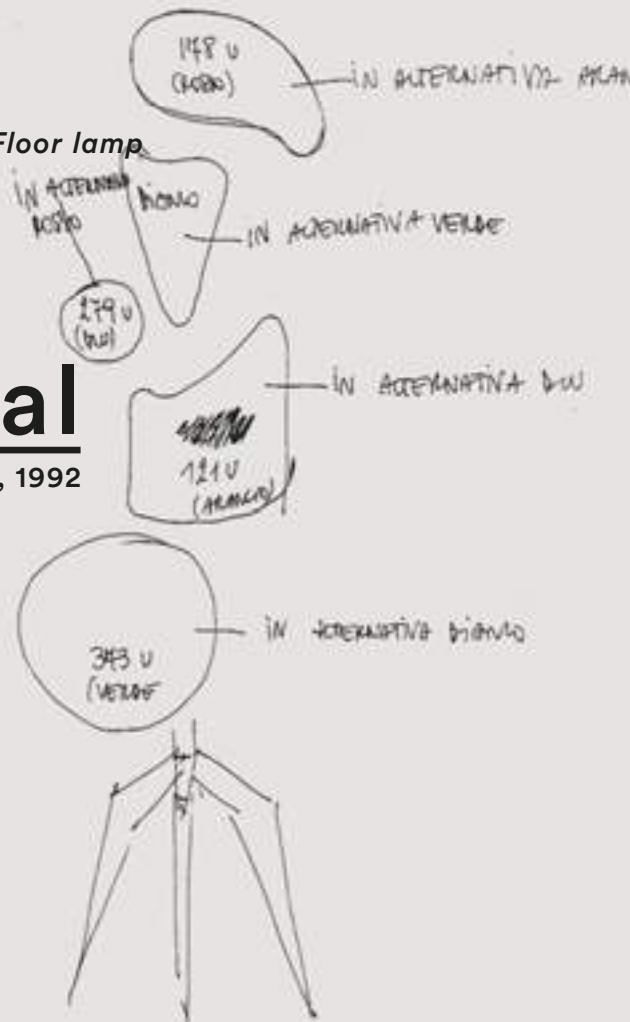

Orbital, scultura domestica. È una lampada o un'installazione artistica? Lanciata nel 1992, considerata fino dal suo apparire come un oggetto unico nell'universo del design, raffigurata addirittura in un francobollo, Orbital è forse entrambe le cose.

Orbital, domestic sculpture. Is it a lamp or artistic installation? Launched in 1992, considered from the onset to be a unique object in the world of design, depicted even in a postage stamp, Orbital is perhaps both these things.

Sculpture



Stories



Una composizione di sagome in vetro serigrafato, ispirate alle forme delle galassie, su una struttura di metallo laccato, dal sapore industriale. Bianca o multicolore, Orbital diffonde un segnale visivo inconfondibile nello spazio attorno a sè, con una luminosità, oltre che con una forma estetica, assolutamente speciale.

Entailing a composition of silk-screen printed glass shapes, inspired by the galaxies, on a lacquered metal structure oozing industrial appeal. White or multi-coloured, Orbital diffuses an unmistakable visual signal into its surroundings, with a brightness, and aesthetic form, that are truly spectacular.

Multicolor



Orbital — Ferruccio Laviani, 1992



Prototipo — Prototype

Le lampadine a vista sono infatti un elemento integrante del design di quest'opera, espressione di una creatività e cultura del progetto tipicamente italiana.

The visible light bulbs in fact form an integral part of the design of this object, the expression of a typically Italian creativity and design culture.

Textes en français, Deutsche Texte, Textos en español → p. 399

Creativity

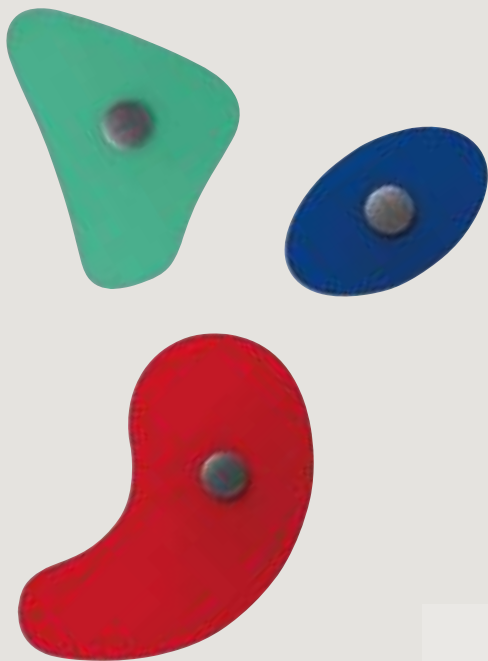

Terra, Floor



Collezioni — 2017

Orbital

Ferruccio Laviani, 1992

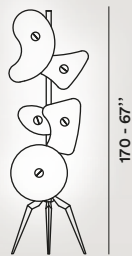

53 - 20 3/4"

Vetro serigrafato e metallo verniciato.
Silkscreen-printed glass and varnished metal.

220 / 240V: halo o LED retrofit 5x30W E14

120V: inc or LED retrofit 5x40W E12

Energy class A+, A, C

CE ⊕ ⚡ IP 20

Bianco, colorato.

White, colored.

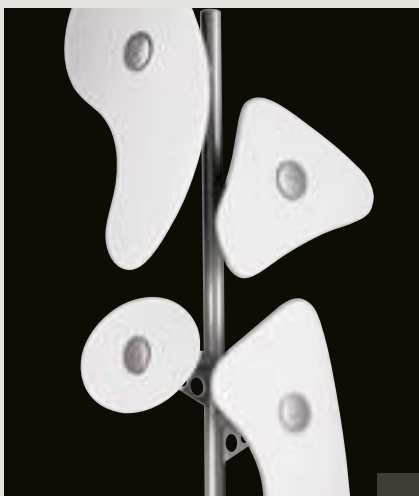

collection →



p. 334

Terra, Floor



Collezioni — 2017

Stewie

Luca Nichetto, 2012



77
30 1/4"



26
10 1/4"

69 - 27"

Polietilene espanso rivestito in tessuto
e metallo verniciato.

*Polyethylene foam coupled with fabric
and lacquered metal.*

220 / 240V - 120V: fluo 1x40W 2GX13

Energy class A+, A

CE    IP 20

Rosso. Red.

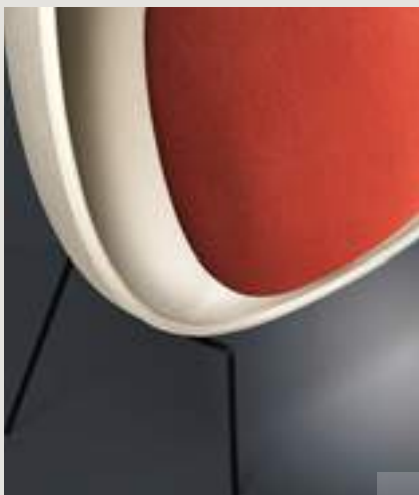

Stories

Collezioni — 2017



Lampada da tavolo, terra, sospensione e parete — *Table, floor, suspension and wall lamp*

Tress

Marc Sadler, 2008

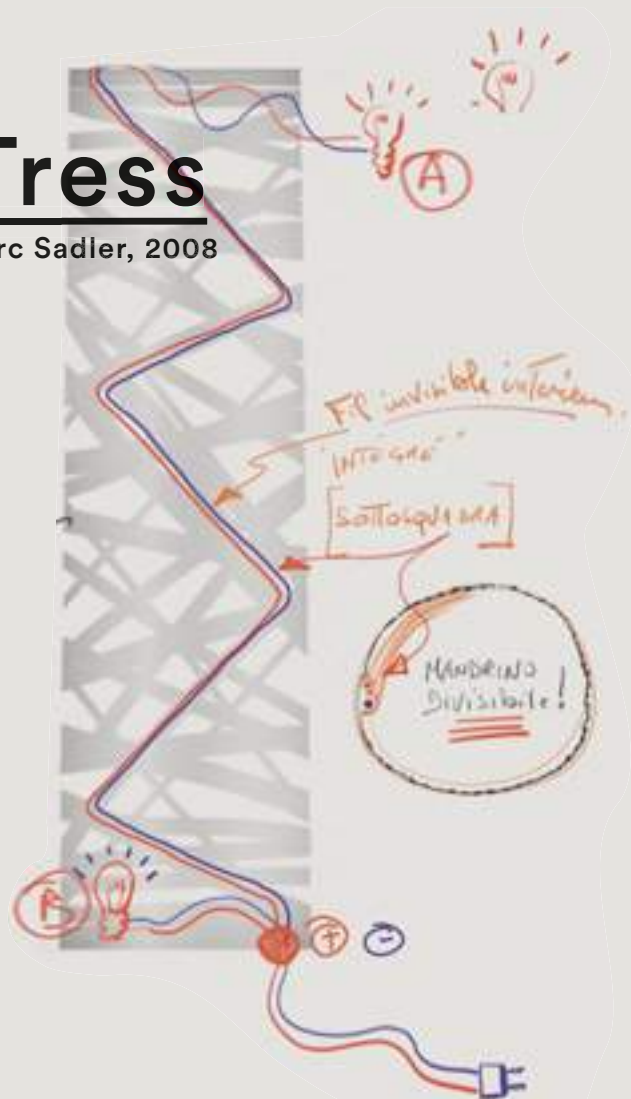

Tress è un intreccio che diventa al tempo stesso struttura portante e decoro, dando forma a un'idea di illuminazione originale, che è già un'icona nel panorama del design della luce.

Tress is a weave and at the same time a supporting structure and decoration, giving shape to an original lighting idea, which has already become an icon in the lighting design field.

Original

Stories

Puro gioco di pieni e di vuoti, luci e ombre, Tress è ottenuta con un processo artigianale. Dall'avvolgimento di nastri in materiale composito, seguendo un pattern apparentemente casuale, si ottiene una forma che porta nello spazio un'atmosfera calda e magica.

A pure interplay of full and empty spaces, light and shadow, Tress is the result of a handcrafted process. By weaving strips of composite material, following a seemingly random pattern, a shape is created that brings a warm and magical atmosphere into the room.

Handcrafted



Collezioni — 2017



Vulcanica in rosso cremisi, sorprendente in blu indaco ed estremamente attuale in greige – un tono tra il grigio ed il beige – Tress porta nuove nuance nelle case e negli spazi collettivi. Ai colori si affiancano il bianco ed il nero, componendo una scelta fra cinque diverse possibilità, ognuna con un fascino particolare. Il risultato è un'ampia famiglia di lampade, particolarmente adatta a grandi composizioni multiple o a progetti di illuminazione coordinati.

Volcanic in crimson red, surprising in indigo blue and extremely contemporary in greige – a shade between grey and beige – Tress brings new nuances to homes and public spaces. The colours are accompanied by black and white versions, making a total of five different possibilities to choose from - each with their own special charm. The result is a large family of lamps, particularly suitable for multiple installations or coordinated lighting projects.

Tress — Marc Sadler, 2008



Textes en français, deutsche Texte, textos en español → p. 402

Up-to-date colors

Terra, Floor



Collezioni — 2017

Tress

Marc Sadler, 2008



grande

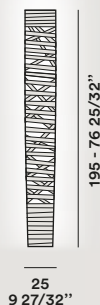

media

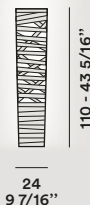

Materiale composito su base di fibra di vetro laccato, metallo verniciato e alluminio. Compound material on lacquered glass fibre base, varnished metal and aluminium.

Tress grande

220 / 240V: LED 56W 2700° K 3721 lm CRI>90

120V: LED 54W 2700° K 4174 lm CRI>90

Energy class A

220 / 240V: halo o LED retrofit 1x100W E27 PAR

+ halo o LED retrofit 1x300W R7s

120V: halo 1x75W E26 PAR + halo 1x300W RSC

Energy class A+, A, C

Dimmer incluso, doppia accensione

— *Dimmer included, double switch*

Tress media

220 / 240V: halo o LED retrofit 1x100W E27 PAR

120V: halo 1x75W E26 PAR

Energy class A+, A, C

Dimmer incluso — *Dimmer included*

☐ CE ⚡ IP 20 — (CCC) (halo grande)

Bianco, nero, cremisi, greige, indaco.

White, black, crimson, greige, indigo.



collection →

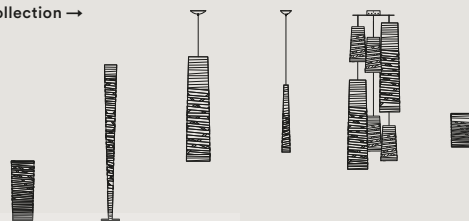

p. 082

p. 138

p. 254-256

p. 258

p. 279

p. 370

Terra, Floor



Collezioni — 2017

Tress Stilo

Marc Sadler, 2011

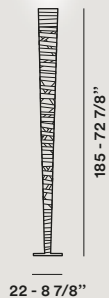

Materiale composito su base di fibra di vetro laccato, metallo verniciato e acciaio
Compound material on lacquered glass fibre base, varnished metal and steel.

220 / 240V: halo o LED retrofit 1x100W E27 PAR
120V: halo 1x75W E26 PAR
Energy class A+, A, C

Dimmer incluso — *Dimmer included*

☐ CE IP 20

Bianco, nero.
White, black.

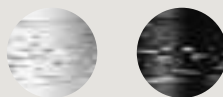

collection →

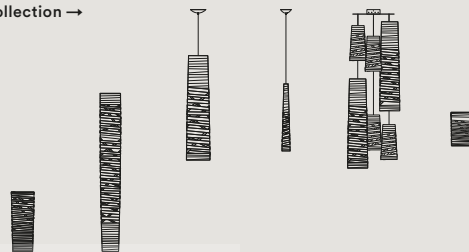

p. 082

p. 132

p. 254-256

p. 258

p. 279

p. 370

Stories



Collezioni — 2017



Lampada da terra — Floor lamp

Tuareg

Ferruccio Laviani, 2013

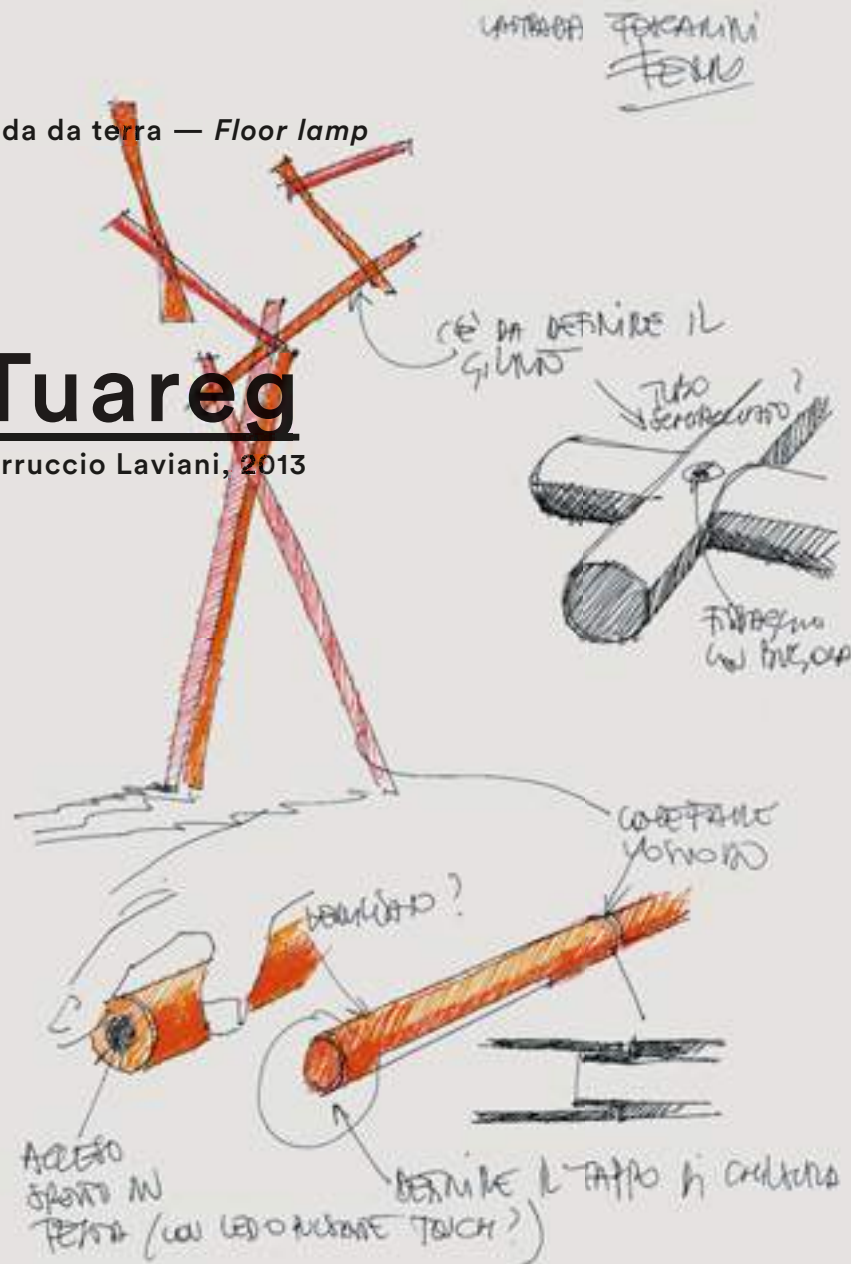

Tuareg, nuova forma di illuminazione. Una lampada da terra che prende ispirazione dalle primitive strutture realizzate nelle culture tribali, legando insieme rami o canne di bambù, per dare vita a un'architettura sorprendente, innovativa.

Tuareg, a new form of lighting. A floor lamp that draws inspiration from the primitive structures built by tribal cultures tying together branches or bamboo canes, that gives life to a surprising, innovative architecture.

Ancestral

Stories

Tuareg — Ferruccio Laviani, 2013

Solo apparentemente caotica ma in realtà estremamente funzionale. Tuareg è formata da tubi in alluminio che compongono una geometria tridimensionale, con luci a LED che si possono accendere con un semplice gesto ed orientare a 360° in maniera indipendente, per creare infinite possibilità di illuminazione.

Apparently chaotic but in reality extremely functional, Tuareg is made of aluminium tubes which create a 3D geometric shape, with LED lights that can be turned on with one simple movement and independently adjusted 360°, to create endless lighting possibilities.



Geometric





Antonio Di Manno



Non solo la forma e la luce, ma anche il colore ha un ruolo importante in Tuareg: un elegante abito nero adatto a ogni occasione, oppure un brillante arancione che ricorda situazioni industriali, per ambienti non convenzionali.

Not just the shape and the light are important for Tuareg, but also the colour: an elegant black suit is perfect for any occasion, or a bright orange overalls to recall industrial environments for the less conventional settings.

Textes en français, Deutsche Texte, Textos en español → p. 403

Graphic



Terra, Floor



Collezioni — 2017

Tuareg

Ferruccio Laviani, 2013

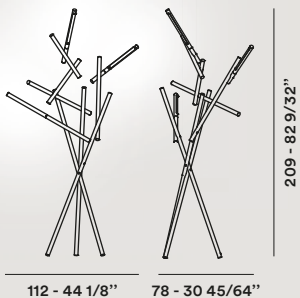

Alluminio verniciato e policarbonato.
Varnished aluminium and polycarbonate.

220 / 240V: LED 54W 3000°K 4050 lm CRI>90
120V: LED 59W 3000°K 4050 lm CRI>90
Energy class A+

Accensioni separate e luci orientabili —
Separate switches and orientable lights
Touch dimmer incluso — *Touch dimmer included*



Arancio, cromo nero.
Orange, black chrome.



Stories



Collezioni — 2017

Lampada da terra, tavolo, sospensione e soffitto — *Floor, table, suspension and ceiling lamp*

Twiggy

Marc Sadler, 2006

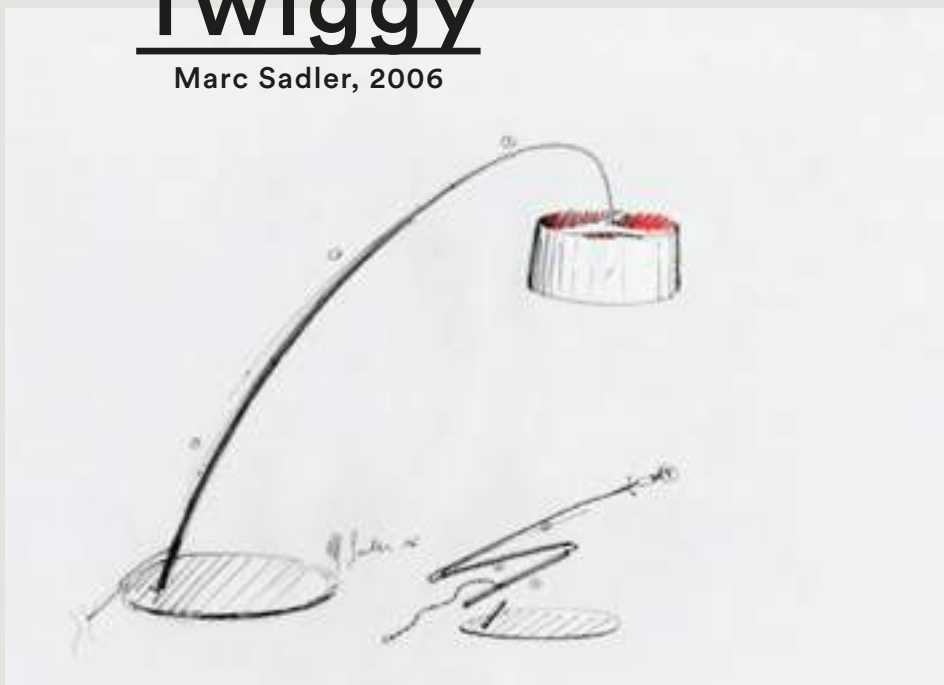

Twiggy, semplicemente geniale.

Immaginate una linea sottilissima, flessibile ed arcuata che, come per magia, sostiene nell'aria un ampio diffusore che illumina contemporaneamente verso il basso con una luce diretta, verso l'alto con una luce soffusa. Fatto? Bene, avete appena immaginato Twiggy, una lampada che unisce la ricerca di una semplicità assoluta, con le possibilità offerte dai materiali contemporanei.

Twiggy, simply genius.

Imagine an ultra-thin, flexible and arched line, which by magic suspends a large diffuser in mid-air, concurrently casting direct light downwards and suffused light upwards. Done? Good, you have just imagined Twiggy, a lamp that teams the pursuit of absolute simplicity with the possibilities given by contemporary materials.

Simple

Stories

Twiggy — Marc Sadler, 2006

Come una canna da pesca, Twiggy si piega armoniosamente ed inoltre è regolabile in altezza per soddisfare ogni esigenza di ambientazione.

Like a fishing rod, Twiggy bends harmoniously and furthermore it is height-adjustable to accommodate all setting requirements.

Clever





A fianco di un divano o una chaise longue,
sopra un tavolo o una scrivania, da sola come
un segno inconfondibile nello spazio, oppure
in scenografiche composizioni: sempre con
un'eccezionale personalità e flessibilità.

Beside a sofa or a reclining armchair,
on top of a table or a desk, either alone as an
unmistakable feature of the setting, or in scenic
compositions: it always has an exceptional
personality and flexibility.

Textes en français, Deutsche Texte, Textos en español → p. 404

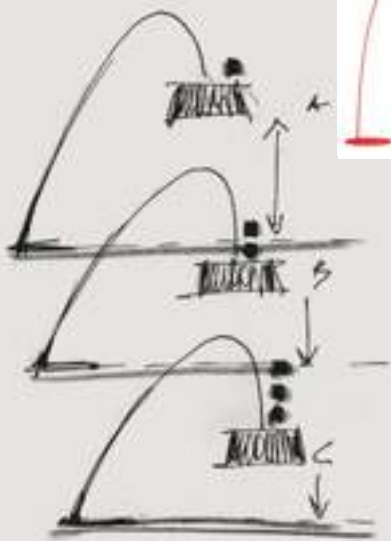
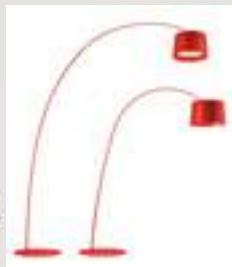

Flexible

Terra, Floor



Collezioni — 2017

Twiggy

Marc Sadler, 2006

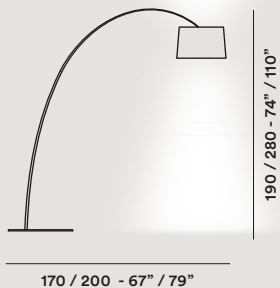

Materiale composito su base di fibra di vetro laccato, PMMA, policarbonato, metallo verniciato e alluminio (LED).

Varnished fibreglass based composite material, PMMA, polycarbonate, varnished metal and aluminium (LED).

220 / 240V: LED 33W 3000° K 3448 lm CRI>90

120V: LED 38W 3000° K 3448 lm CRI>90

Energy class A+

Dimmer incluso — *Dimmer included*

220 / 240V: halo o LED retrofit 3x77W E27

120V: halo 3x100W E26

Energy class A+, A, C

Dimmer incluso — *Dimmer included*

CE IP 20 — (halo)

Bianco, nero, cremisi, greige, indaco.

White, black, crimson, greige, indigo.

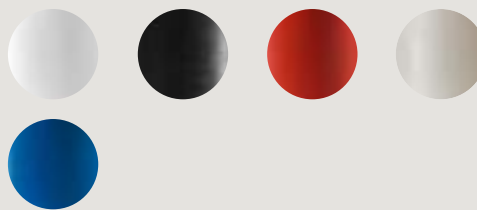

collection →

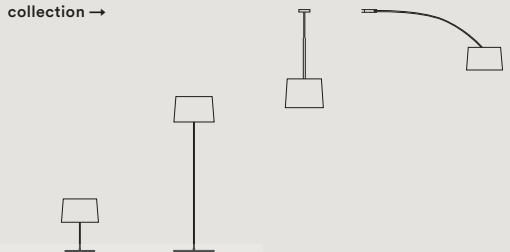

p. 084

p. 156

p. 266

p. 318

Terra, Floor



Collezioni — 2017



Terra, Floor



Collezioni — 2017

Twice as Twiggy

Marc Sadler, 2015

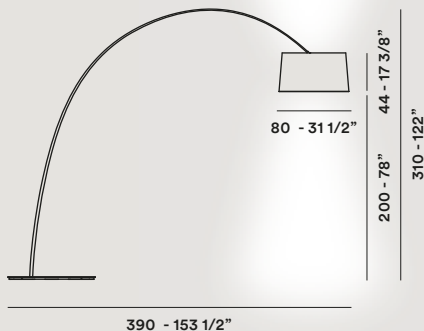

Materiale composito su base di fibra di vetro laccato, PMMA, metallo verniciato e alluminio.

Coated fibreglass-based composite material, PMMA, coated metal and aluminium.

220 / 240V: LED 81W 3000° K 8517 lm CRI>90

120V: LED 95W 3000° K 8517 lm CRI>90

Dimmer incluso — *Dimmer included*

Energy class A+



Bianco, nero, cremisi, greige, indaco.

White, black, crimson, greige, indigo.

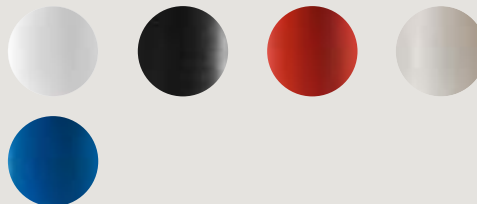

collection →



Terra, Floor



Collezioni — 2017

Twiggy lettura

Marc Sadler, 2008



Materiale composito su base di fibra di vetro laccato, PMMA, policarbonato e metallo verniciato.

Coated fibreglass based composite material, PMMA, polycarbonate and varnished metal.

220 / 240V: halo o LED retrofit 3x77W E27

120V: inc 3x100W E26

Energy class A+, A, C

Dimmer incluso — *Dimmer included*

☐ CE IP 20

Bianco, nero.

White, black.



collection →

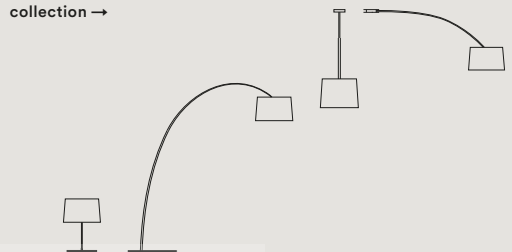

p. 084

p. 146

p. 266

p. 318



Sospensione — *Suspension*

160	Allegro	220	Maki
166	Allegretto	222	O-Space
168	Aplomb	224	Planet
172	Aplomb mini	226	Plass grande
174	Aplomb Large	228	Plass media
178	Behive	230	Rituals
180	Big Bang	232	Rituals XL
186	Big Bang L + XL	234	Spokes
188	Birdie	240	Spokes Large
190	Buds	244	Supernova
192	Caboche	246	Tartan
198	Caboche piccola	252	Tite
200	Caiigo	254	Tress
202	Chouchin	256	Tress grande
204	Chouchin mini	258	Tress Stilo
206	Chouchin Reverse	260	Troag
208	Giga-Lite	264	Tropico
210	Gregg	266	Twiggy
212	Havana	268	Twice as Twiggy
214	Jamaica	270	Uto
216	Le Soleil	272	Wave
218	Lightweight		



Stories



Collezioni — 2017

Lampada da sospensione — *Suspension lamp*

Allegro

Atelier Oi, 2007

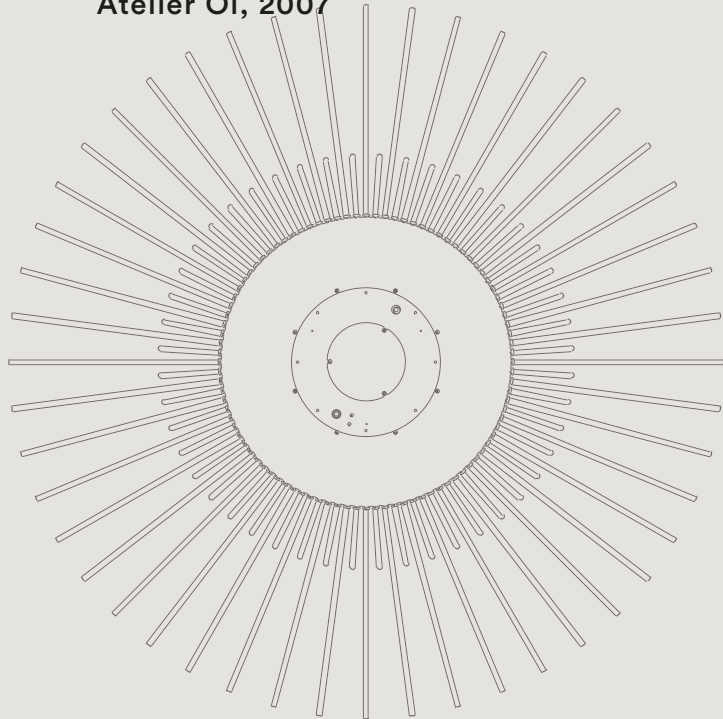

Allegro, sinfonia di luci e ombre. A prima vista può sembrare uno strumento musicale o una sorprendente scenografia che si libra nell'aria, in realtà è un modo del tutto speciale di illuminare e caratterizzare lo spazio.

Allegro, a symphony of lights and shadows. At first glance it may look like a musical instrument or a stunning set-up that soars into the air, but in reality Allegro has a very special way of lighting and decorating a space.

Lights & shadows

Stories



Allegro è un progetto che accosta linee sottili, realizzate con tubi di alluminio, in forme tridimensionali, sospese e immateriali, attraverso le quali la luce si diffonde nell'ambiente, vestendolo di magici giochi d'ombre.

Allegro is a project that combines thin lines, made of aluminium tubes, into suspended and immaterial three-dimensional shapes, through which the light is cast into the room, adorning it with magical games of shadows.

Gravity



Allegro — Atelier Oï, 2007



Come le note musicali, Allegro si presta a infinite situazioni: intime, romantiche o maestose. Allegro e Allegretto Ritmico, Vivace ed Assai sono ambientabili da sole oppure in gruppo, in casa come negli spazi dedicati al grande pubblico.

Like musical notes, Allegro lends itself to endless locations, whether cosy and intimate, romantic or majestic. Allegro and Allegretto Ritmico, Vivace and Assai can be used alone or in multiple compositions, at home as well as in settings for the general public.

Textes en français, Deutsche Texte, Textos en español → p. 392

Musical

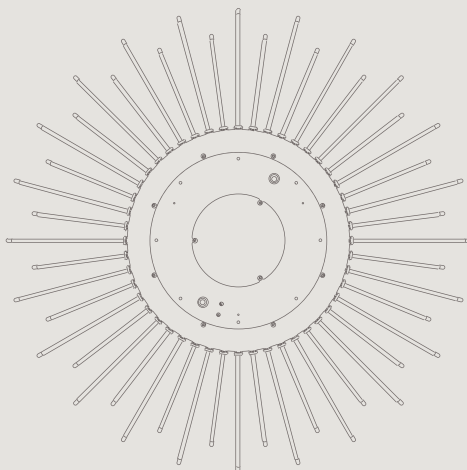

Sospensione, *Suspension*



Collezioni — 2017

Allegro

Atelier Oï, 2007

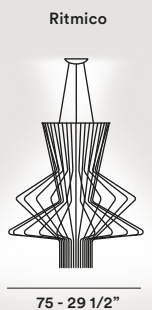
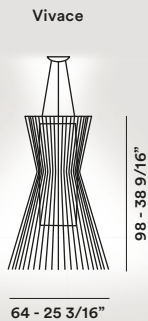
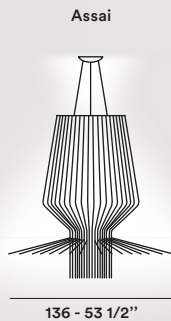

Alluminio verniciato e metallo cromato.
Varnished aluminium and metal.

LED 51W 3000°K 4266 lm CRI>90
Energy class A+

Dimmerabile — *Dimmable*
Doppia accensione — *Double switch*

220 / 240V: halo o LED retrofit 1x100W E27 PAR
+ halo o LED retrofit 1x230W R7s
120V: halo or LED retrofit 1x75W E26 PAR
+ halo or LED retrofit 1x200W RSC
Energy class A+, A, C

CE IP 20 — (halo)

Assai oro, Vivace rame, Ritmico grafite.
Assai gold, Vivace copper, Ritmico graphite.

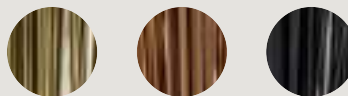

Sospensione, *Suspension*



Collezioni — 2017

Allegretto

Atelier Oï, 2009



Alluminio verniciato e metallo cromato.
Varnished aluminium and metal.

220 / 240V: halo o LED retrofit 2×100W E27 PAR
120V: halo or LED retrofit 2×75W E26
Energy class A+, A, C



Assai oro, Vivace rame, Ritmico grafite.
Assai gold, Vivace copper, Ritmico graphite.

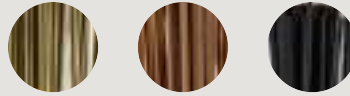

Stories



Collezioni — 2017

Lampada da sospensione — *Suspension lamp*

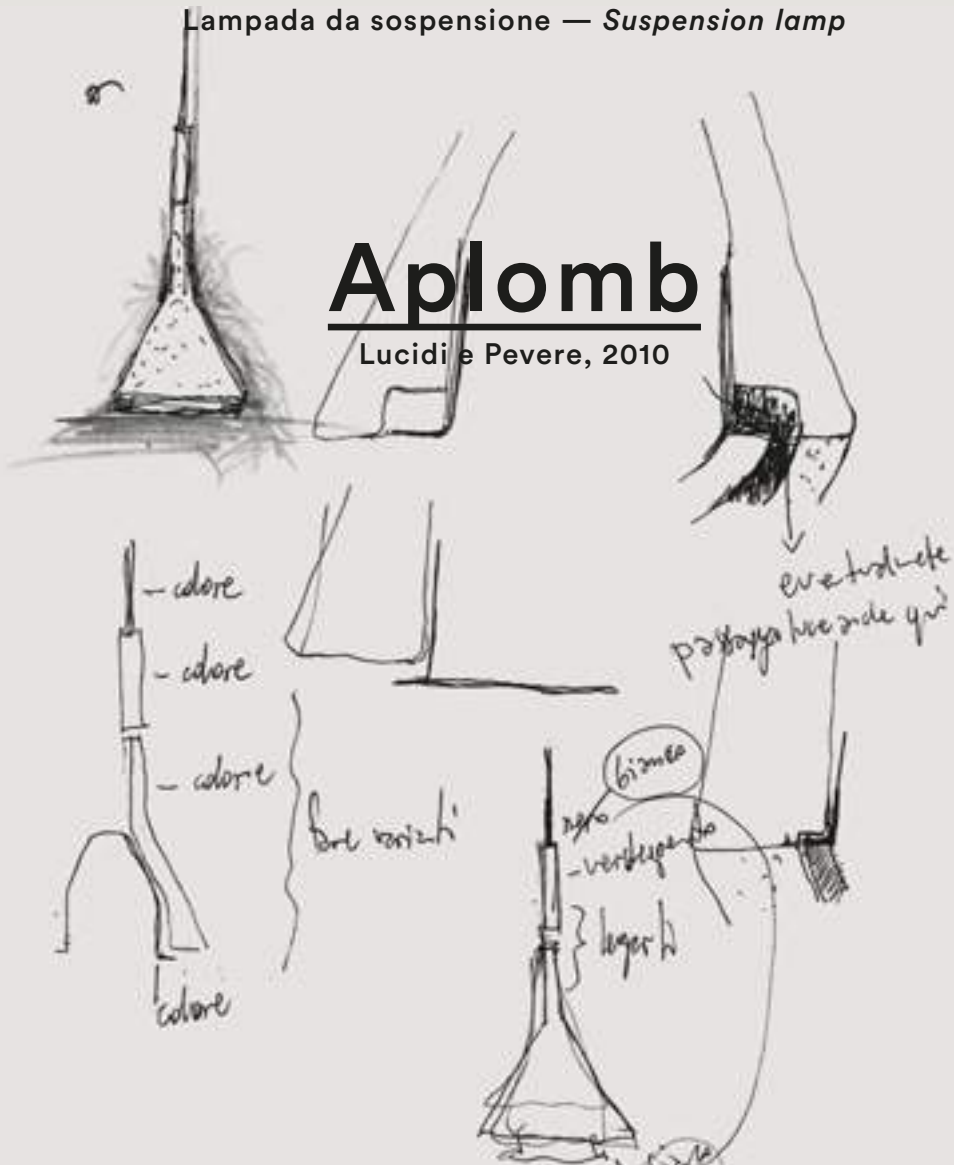

Aplomb

Lucidi e Pevere, 2010

Nata dalla volontà di utilizzare il cemento grezzo, materia tipica delle grandi strutture architettoniche moderne, per creare un oggetto illuminante dalle forme sottili e raffinate, la lampada Aplomb ha ottenuto fin dal suo esordio un grande successo.

Born from the desire to use rough concrete, typical of large modern buildings, to create a light object in slender, refined forms, the Aplomb lamp has been hugely successful ever since its inception.

Essential

Stories

Aplomb — Lucidi e Pevere, 2010

Aplomb viene realizzata grazie a un processo artigianale da esperti italiani nella lavorazione del cemento. La sfida progettuale è stata ottenere spessori sottili, forme leggere e una superficie materica ma allo tempo stesso piacevole al tatto. Un risultato raggiunto grazie alla cura e alla profonda conoscenza del materiale, che ha portato ad individuare un amalgama speciale, particolarmente fluido nello stampo durante la realizzazione.

Aplomb is made by Italian experts through a craft-based process of concrete processing. The challenge at the heart of this project was to obtain slim thicknesses, light-weight shapes and a textured surface, still pleasant to touch. It was all achieved thanks to the painstaking care and profound knowledge of the raw material, which allowed the creation of a special mix, particularly fluid when poured into the cast.

Handcrafted



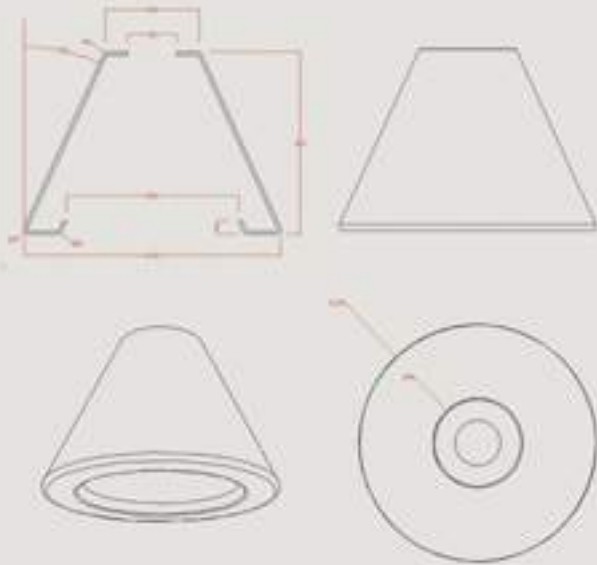

Da questo materiale è nata anche una versione più piccola – Aplomb mini – utilizzabile da sola o in abbinamento al modello originale e Aplomb Large, un modello più grande, con forma e caratteristica di impiego diverse. Aplomb Large si avvale di una sorgente luminosa a LED integrata collocata a incasso nel corpo della lampada, che offre un ampio raggio di luce verso il piano sottostante, mentre la versione originale di Aplomb si caratterizza per l'illuminazione puntuale.

By using the same material, Foscarini proposes an even smaller version – Aplomb mini – which can be used alone or together with the matching original model and Aplomb Large, a larger version with a different shape and use. Aplomb Large is fitted with a built-in LED light source, placed into the body of the lamp, which casts a wide beam of light onto the surface underneath, unlike the original Aplomb version which instead stands out for its accent lighting.

Textes en français, deutsche Texte, textos en español → p. 392



Special concrete



Sospensione, *Suspension*



Collezioni — 2017

Aplomb – Aplomb mini

Lucidi e Pevere, 2010/2015

Aplomb

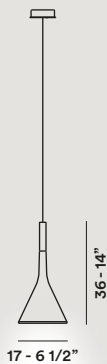

Aplomb mini



Cemento e alluminio.
Concrete and aluminium.

Aplomb

220 / 240V: halo o LED retrofit 1x60W G9

1x8W LED retrofit GU10 PAR

120V: halo or LED retrofit 1x60W G9

1x8W LED retrofit GU10 PAR

Energy class A+, A, C

Aplomb mini

220 / 240V: 1x8W LED retrofit GU10 PAR

120V: 1x9W LED retrofit GU10 PAR

Energy class A+, A

CE   IP 20 —  (GU10)

Bianco, grigio cemento, marrone.
White, concrete grey, brown.



collection →

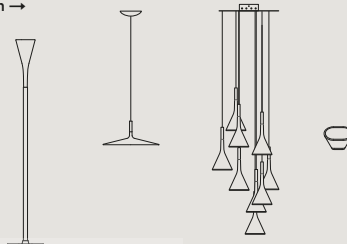

p. 084

p. 174

p. 278

p. 322

Stories



Collezioni — 2017

175



Sospensione, *Suspension*



Collezioni — 2017

Aplomb Large

Lucidi e Pevere, 2016

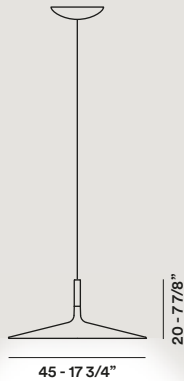

Cemento, alluminio e policarbonato.
Concrete, aluminium and polycarbonate.

220 / 240V: LED 11,7W 2700° K 1279 lm CRI>90

120V: LED 9,2W 2700° K 897 lm CRI>90

Dimmerabile — *Dimmable*

Energy class A+



Bianco, grigio cemento, marrone.
White, concrete grey, brown.



collection →

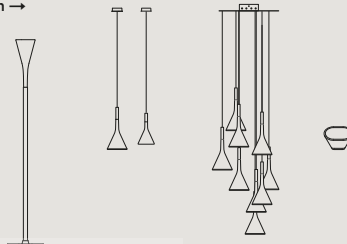

p. 094

p. 168

p. 278

p. 322

Sospensione, *Suspension*



Collezioni — 2017

Behive

Werner Aisslinger, 2012

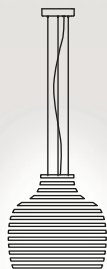

39 - 15 1/4"

39 - 15 1/4"

ABS masterizzato e policarbonato.
Batch-dyed ABS and polycarbonate.

220 / 240V: halo 1x150W E27,
fluo o LED retrofit 1x25W E27
120V: halo 1x150W E26,
fluo or LED retrofit 1x26W E26
Energy class A+, A, C

CE ⚡ IP 20

Bianco. *White.*



collection →



p. 022

Stories



Collezioni 2017

Lampada da sospensione, soffitto e parete — *Suspension, ceiling and wall lamp*

Big Bang

Enrico Franzolini con Vicente Garcia Jimenez, 2005



Big Bang, forza esplosiva. Solo Foscarini poteva trasformare un'idea così estrema, inedita, ispirata all'arte contemporanea ed all'architettura d'avanguardia, in una lampada di grandissimo successo.

Big Bang, explosive force. Only Foscarini could turn such an extreme and innovative idea inspired by contemporary art, and cutting-edge architecture into a highly successful lamp.

Explosion



Stories

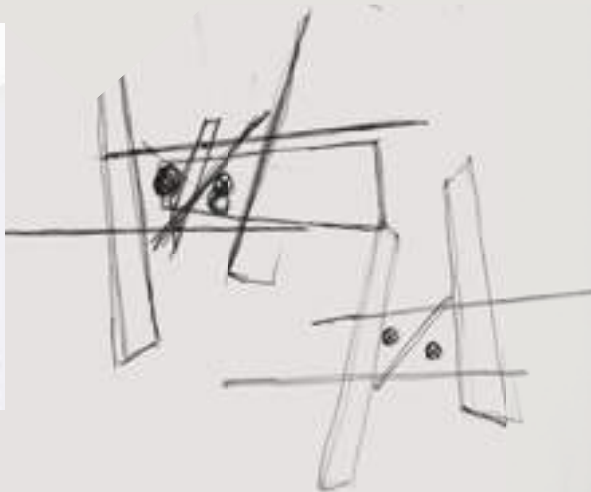

Realizzata in metacrilato e alluminio verniciato, Big Bang è un'esplosione di piani che si intersecano, creando molteplici giochi di luci e ombre, con un'illuminazione diretta e riflessa allo stesso tempo.

Made of methacrylate and painted aluminium, Big Bang is an explosion of criss-crossing forms which create multiple interplays of light and shadow, with direct and concurrently reflected light.

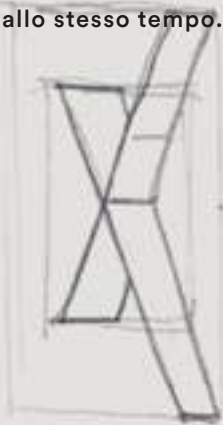

Sculptural



**Big Bang — Enrico Franzolini
con Vicente Garcia Jimenez, 2005**



Un effetto ulteriormente sottolineato nella versione bicolore, oppure reso più sfumato in quella monocromatica, per una lampada che, in ogni caso, non nasce per passare inosservata. Nella versione a LED, all'inconfondibile presenza scenica e illuminotecnica, si aggiunge un'ancora maggiore efficienza energetica.

This effect is further emphasised in the two-colour version, or lent a softer hue in the monochromatic white. A lamp that was not born to go unnoticed in any circumstance. In the LED version, a greater energy efficiency is added to its unmistakable scenic lighting presence.

Textes en français, Deutsche Texte, Textos en español → p. 394

Signal

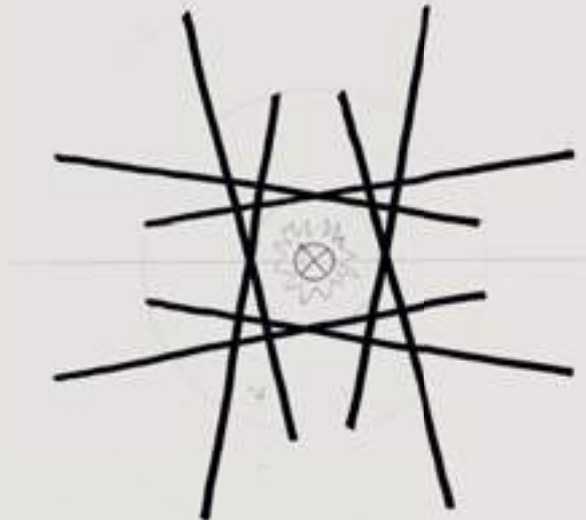

Sospensione, *Suspension*



Collezioni — 2017

Big Bang



Enrico Franzolini con Vicente Garcia Jimenez, 2005

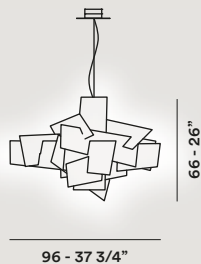

Metacrilato e alluminio verniciato.
Methacrylate and varnished aluminium.

220 / 240V: LED 37,7W 3000° K 3885 lm CRI>90
halo o LED retrofit 1x160W R7s,
fluo 1x26W GX24q-3
120V: LED 41W 3000° K 3885 lm CRI>90
halo o LED retrofit 1x200W RSC,
fluo 1x26W GX24q-3
Energy class A+, A, C

CE IP 20 (halo)

Bianco, rosso.
White, red.

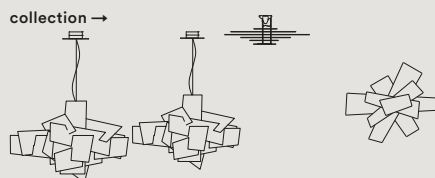

p. 186

p. 294

p. 330

Sospensione, *Suspension*



Collezioni — 2017

Big Bang L + XL



Enrico Franzolini con Vicente Garcia Jimenez, 2005/2016

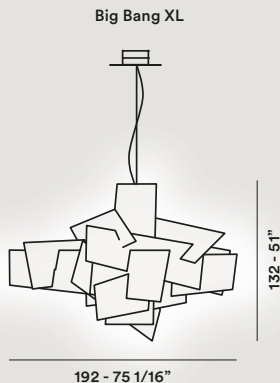
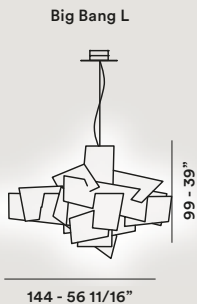

Metacrilato e alluminio verniciato.
Methacrylate and varnished aluminium.

Big Bang L
220 / 240V: LED 58W 3000° K 6084 lm CRI>90
120V: LED 66W 3000° K 6084 lm CRI>90
Dimmerabile — *Dimmable*
Energy class A+, A

Big Bang XL
220 / 240V: LED 87W 3000° K 9126 lm CRI>90
halo o LED retrofit 1x160W R7s
120V: LED 98W 3000° K 6084 lm CRI>90
halo or LED retrofit 1x200W RSC
Dimmerabile — *Dimmable*
Energy class A+, A, C



Bianco, rosso.
White, red.



collection →



p. 180

p. 294

p. 330

Sospensione, *Suspension*



Collezioni — 2017

Birdie

Ludovica + Roberto Palomba, 2015

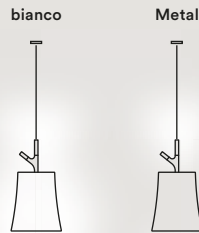
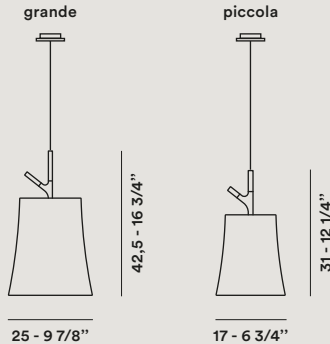

Policarbonato e metallo verniciato
o metallizzato.
*Metallized polycarbonate
and metallized steel.*

Birdie bianco grande
220 / 240V: halo 1x150W E27,
fluo o LED retrofit 1x25W E27
120V: halo 1x150W E26,
fluo or LED retrofit 1x26W E26
Energy class A+, A, C

Birdie bianco piccola
220 / 240V: halo 1x70W E27,
fluo o LED retrofit 1x20W E27
120V: halo 1x60W E26,
fluo or LED retrofit 1x20W E26
Energy class A+, A, C

Birdie Metal grande
220 / 240V: fluo o LED retrofit 1x25W E27
120V: fluo or LED retrofit 1x26W E26
Energy class A+, A

Birdie Metal piccola
220 / 240V: fluo 1x20W E27
120V: fluo 1x20W E26
Energy class A+, A

CE   IP 20

Bianco, cromo nero, rame.
White, black chrome, copper.



Sospensione, *Suspension*

Collezioni — 2017



Buds

Rodolfo Dordoni, 2016

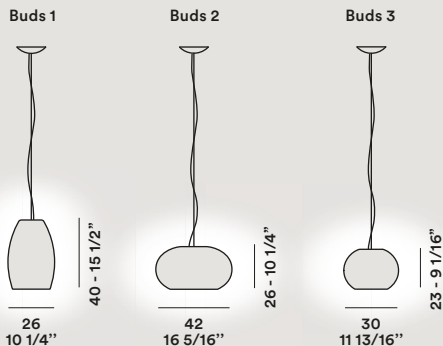

Vetro soffiato. *Blown glass.*

220 / 240V: LED 24W 2700° K 2676 lm CRI>90

120V: LED 23W 2700° K 2291 lm CRI>90

Dimmerabile — *Dimmable*

220 / 240V: fluo o LED retrofit max 1x23W

– globe Ø 9 - 12 cm

120V: fluo or LED retrofit max 1x23W

– type G40 Ø 3 3/4" - 4 3/4"

Energy class A+, A

Raccomandata lampadina a globo bianco.

White globe bulb recommended.



Buds 1 marrone, bianco caldo.

Buds 1 brown, warm white.



Buds 2 grigio, bianco caldo.

Buds 2 grey, warm white.



Buds 3 verde bambù, bianco caldo.

Buds 3 bamboo green, warm white.



collection →

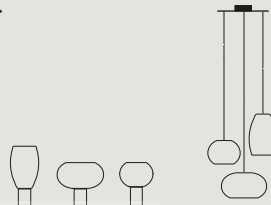

p. 036

p. 276

Stories



Collezioni — 2017

Lampada da tavolo, terra, sospensione, soffitto e parete — *Table, floor, suspension, ceiling and wall lamp*

Caboche

Patricia Urquiola con Eliana Gerotto, 2005

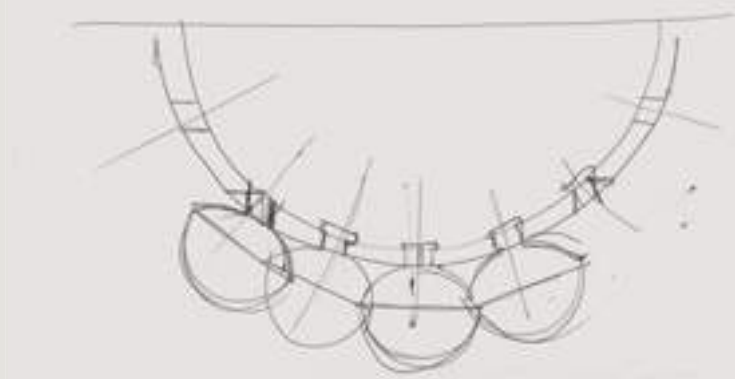

Caboche, gioiello di design. Le donne sanno sempre cogliere gli aspetti più inattesi delle cose. Quando poi si tratta di due donne designer, dalla loro creatività non può nascere altro che una lampada tanto sorprendente, quanto affascinante: Caboche.

Caboche, design gem. Women always know how to make the most out of the unexpected. When these women are two designers, their combined creativity could not lead to anything other than a charming and disarming lamp: Caboche.

Jewel

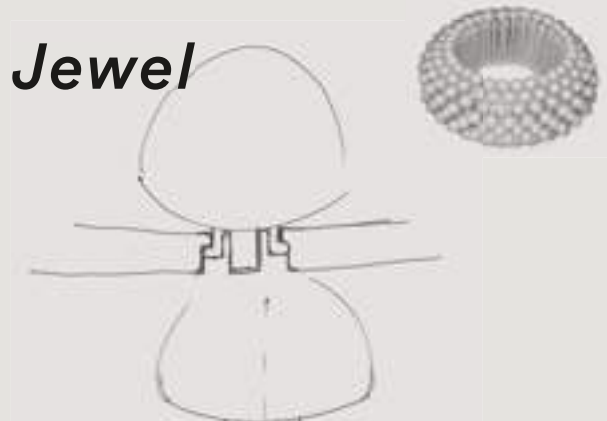

Stories

Caboche — Patricia Urquiola con Eliana Gerotto, 2005



La sua forma prende ispirazione da un bracciale di perle, ma si trasforma in una composizione di sfere trasparenti, scintillanti come diamanti ma realizzate con un materiale leggero, resistente e tecnologicamente contemporaneo: il polimetilmetacrilato, in versione cristallo o giallo oro.



Its shape was inspired by a pearl bracelet, but it turns into a composition of sparkling transparent spheres, gleaming like diamonds but made with a lightweight, hard-wearing and technologically contemporary material: polymethylmethacrylate or PMMA, in transparent or yellow gold version.

Prototipi — Prototypes

Brilliant

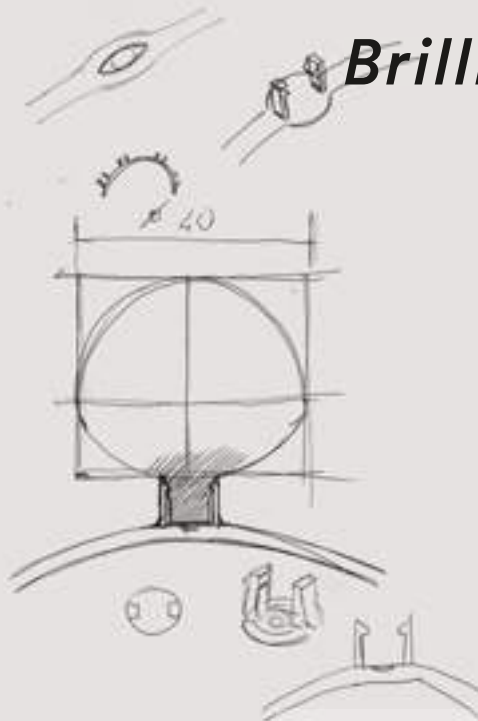



Le sfere possono dare vita a lampade di varie misure, dal piccolo modello a sospensione, alla grande installazione, creando irresistibili gioielli luminosi che aggiungono un fascino prezioso agli ambienti più diversi.

The spheres can form lamps of various sizes, from a small suspension model to a large installation, creating irresistible luminous gems that add precious charm to the most disparate settings.

Textes en français, Deutsche Texte, Textos en español → p. 395

Transparent

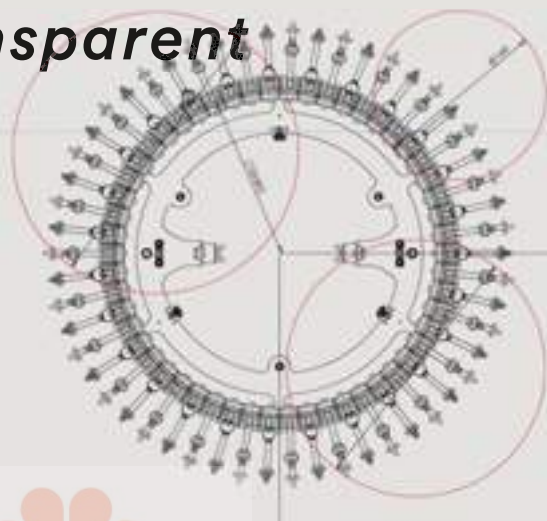

Sospensione, *Suspension*



Collezioni — 2017

Caboche



Patricia Urquiola con Eliana Gerotto, 2005

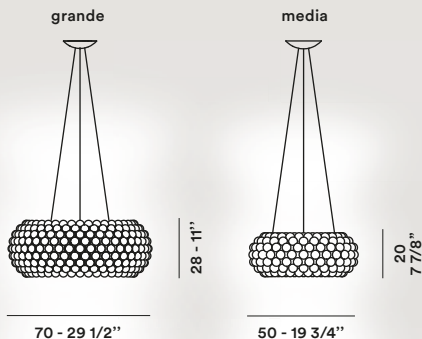

Polimetilmetacrilato, vetro soffiato, metallo cromato e alluminio (LED).
PMMA, blown glass, chromed metal and aluminium (LED).

Caboche grande

220 / 240V: LED 46W 3000° K 4330 lm CRI>90

120V: 60W 3000° K 5051 lm CRI>90

Energy class A+

Dimmerabile — Dimmable

220 / 240V: halo o LED retrofit 1x230W R7s

120V: halo or LED retrofit 1x200W RSC

Energy class A+, A, C

Caboche media

220 / 240V: LED 35W 3000° K 3653 lm CRI>90

120V: LED 47W 3000° K 3653 lm CRI>90

Energy class A+

Dimmerabile — Dimmable

220 / 240V: halo o LED retrofit 1x160W R7s

120V: halo or LED retrofit 1x150W RSC

Energy class A+, A, C

CE IP 20 — (halo)

Trasparente, giallo oro. *Transparent, gold yellow.*

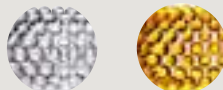

collection →

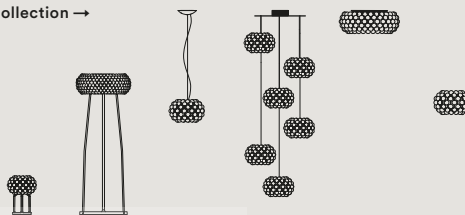

p. 044

p. 098

p. 198

p. 278

p. 300

p. 338

Sospensione, *Suspension*

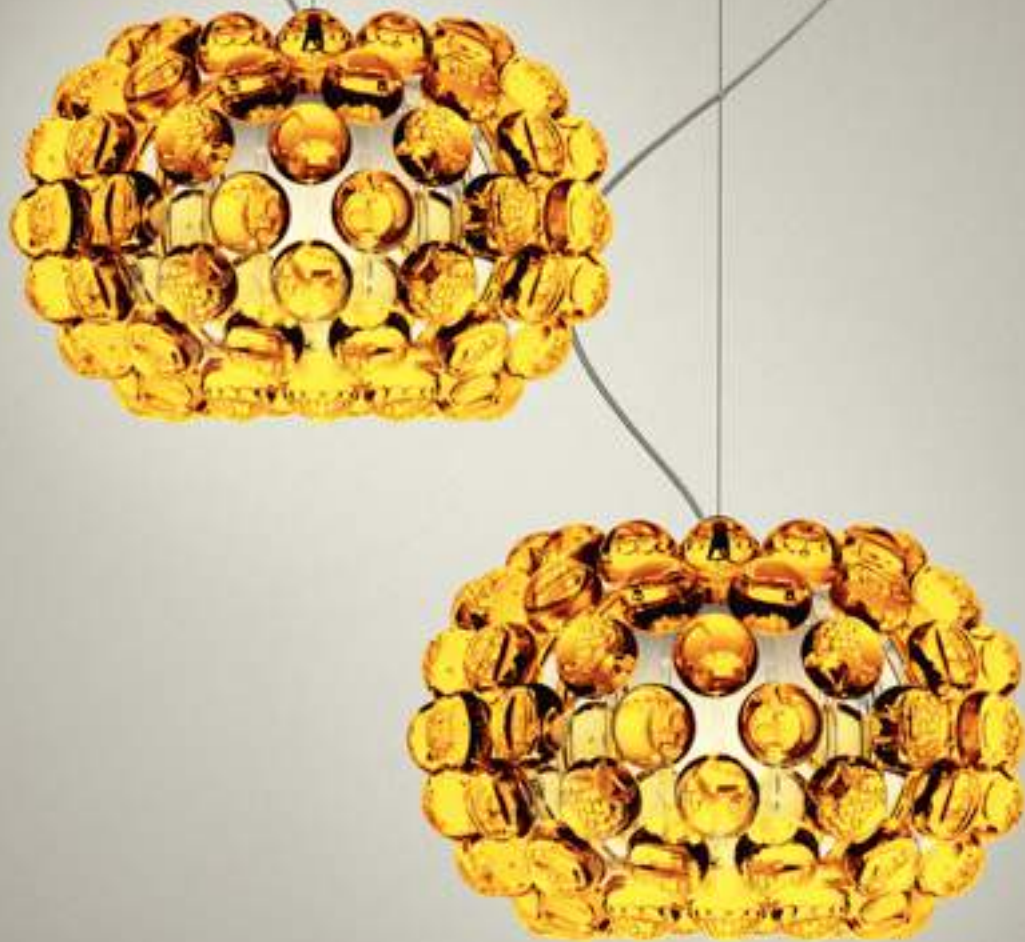

Collezioni — 2017

Caboche piccola

Patricia Urquiola con Eliana Gerotto, 2005

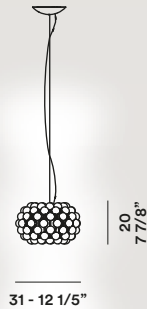

Polimetilmetacrilato, vetro soffiato e metallo cromato.
PMMA, blown glass, chromed metal.

220 / 240V: halo o LED retrofit 1x60W G9
120V: halo or LED retrofit 1x60W G9
Energy class A+, A, C



Trasparente, giallo oro.
Transparent, gold yellow.

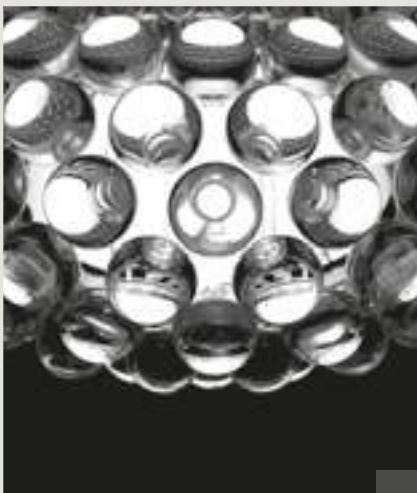
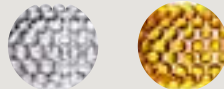

collection →

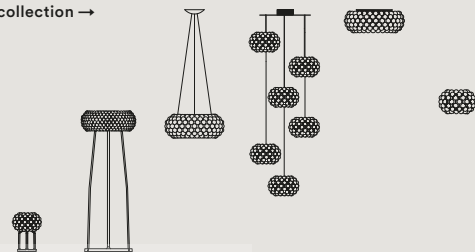

p. 044

p. 098

p. 192

p. 278

p. 300

p. 338

Sospensione, *Suspension*



P

Collezioni — 2017



Caiigo

Marco Zito, 2015

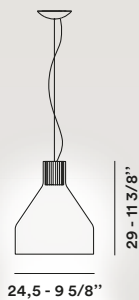

Vetro soffiato e alluminio.
Blown glass and aluminium.

220 / 240 - 120V: LED retrofit 1x8W GU10 PAR
halo 1x35W GU10 PAR
Energy class A+, A, C

CE  IP 20

Bianco sfumato.
Fading white.



Sospensione, *Suspension*



Collezioni — 2017

Chouchin

Ionna Vautrin, 2011

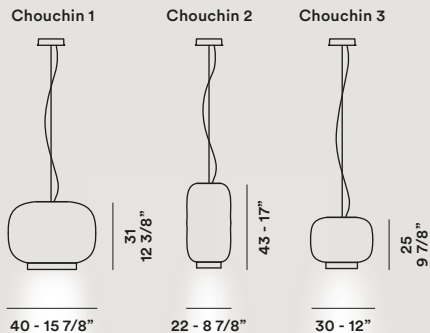

Vetro soffiato verniciato.
Lacquered blown glass.

220 / 240V: LED 24W 2700° K 2676 lm CRI>90
120V: 23W 2700° K 2291 lm CRI>90
Energy class A+
Dimmerabile — *Dimmable*

220 / 240V: halo o LED retrofit 1x100W E27 PAR
halo 1x150W E27, fluo o LED retrofit 1x25W E27
120V: halo or LED retrofit 1x75W E26 PAR
halo 1x150W E26, fluo or LED retrofit 1x26W E26
Energy class A+, A, C

CE IP 20 — (halo)

Chouchin 1 arancio, Chouchin 2 verde,
Chouchin 3 grigio.
*Chouchin 1 orange, Chouchin 2 green,
Chouchin 3 grey.*



collection →

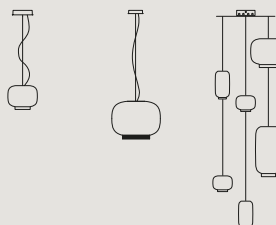

p. 204

p. 206

p. 278

Sospensione, *Suspension*



Collezioni — 2017

Chouchin mini

Ionna Vautrin, 2013

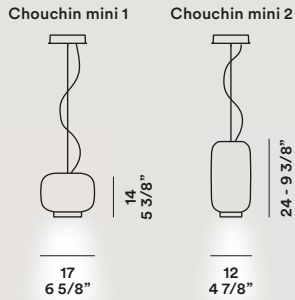

Vetro soffiato verniciato.
Lacquered blown glass.

halo o LED retrofit 1x35W GU10
Energy class A+, A, C

CE  IP 20

Chouchin 1 arancio, Chouchin 2 verde.
Chouchin 1 orange, Chouchin 2 green.



collection →

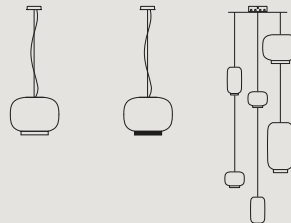

p. 202

p. 206

p. 278

Sospensione, *Suspension*



Collezioni — 2017

Chouchin Reverse



Ionna Vautrin, 2015

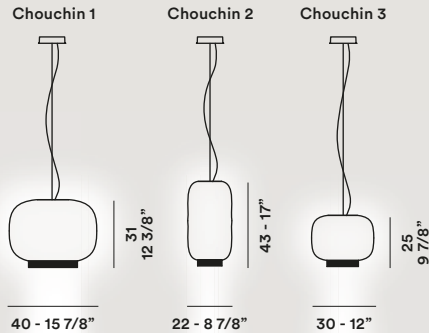

Vetro soffiato verniciato.
Lacquered blown glass.

220 / 240V: LED 24W 2700° K 2676 lm CRI>90
120V: 23W 2700° K 2291 lm CRI>90

Energy class A+
Dimmerabile — Dimmable

220 / 240V: halo 1x150W E27
flu o LED retrofit 1x26W E27
120V: halo 1x150W E26
flu o LED retrofit 1x25W E26
Energy class A+, A, C

CE IP 20 — (halo)

Chouchin 1 Bianco / arancio, Chouchin 2
bianco / verde, Chouchin 3 bianco / grigio.
Chouchin 1 white / orange, Chouchin 2 white /
green, Chouchin 3 white / grey.



collection →

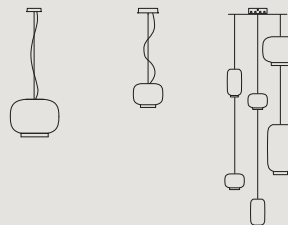

p. 202

p. 204

p. 287

Sospensione, *Suspension*



Collezioni — 2017

Giga-Lite

Marc Sadler, 2004

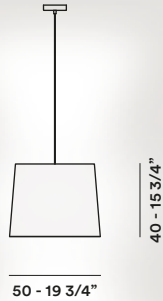

Tessuto di vetro con fibra di carbonio e metallo nichelato.
Fiberglass fabric with carbonium thread and nickelplated metal.

220 / 240V: halo 3x77W E27,
fluo o LED retrofit 3x20W E27
120V: inc 3x100W E26,
fluo or LED retrofit 3x20W E26
Energy class A+, A, C

CE  IP 20

Nero. Black.



collection →

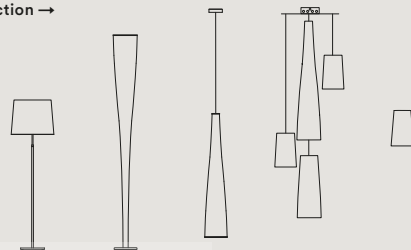

p. 102

p. 118

p. 252

p. 282

p. 356

Sospensione, *Suspension*



Collezioni — 2017

Gregg

Ludovica + Roberto Palomba, 2007

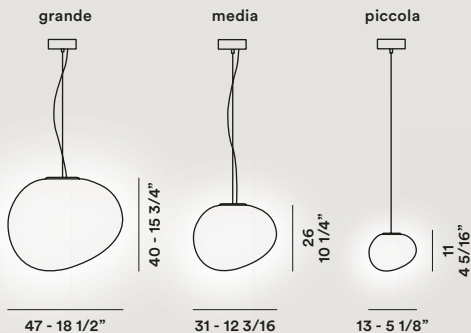

Vetro soffiato satinato. *Blown acid-etched glass.*



Gregg grande

220 / 240V: LED 24W 2700° K 2676 lm CRI>90
dimmerabile — *dimmable*
halo 1x205W E27, fluo o LED retrofit 1x30W E27
120V: 23W 2700° K 2291 lm CRI>90
halo 1x150W E26, fluo or LED retrofit 1x26W E26

Gregg media

220 / 240V: LED 24W 2700° K 2581 lm CRI>90
dimmerabile — *dimmable*
halo 1x150W E27, fluo o LED retrofit 1x25W E27
120V: 23W 2700° K 2291 lm CRI>90
halo 1x100W E26, fluo or LED retrofit 1x26W E26

Energy class A+, A, C

CE   IP 20 —  (grande - media)

Gregg piccola

220 / 240V: halo o LED retrofit 1x33W G9
120V: halo or LED retrofit 1x40W G9

Energy class A+, A, C

CE   IP 20

Bianco. *White.*



collection →

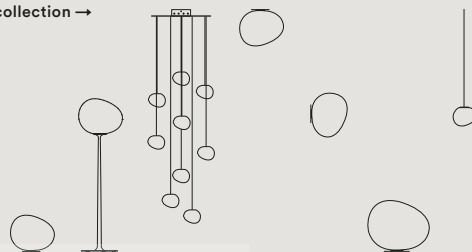

p. 050 p. 104 p. 286 p. 308 p. 350 p. 378 p. 376

Sospensione, *Suspension*

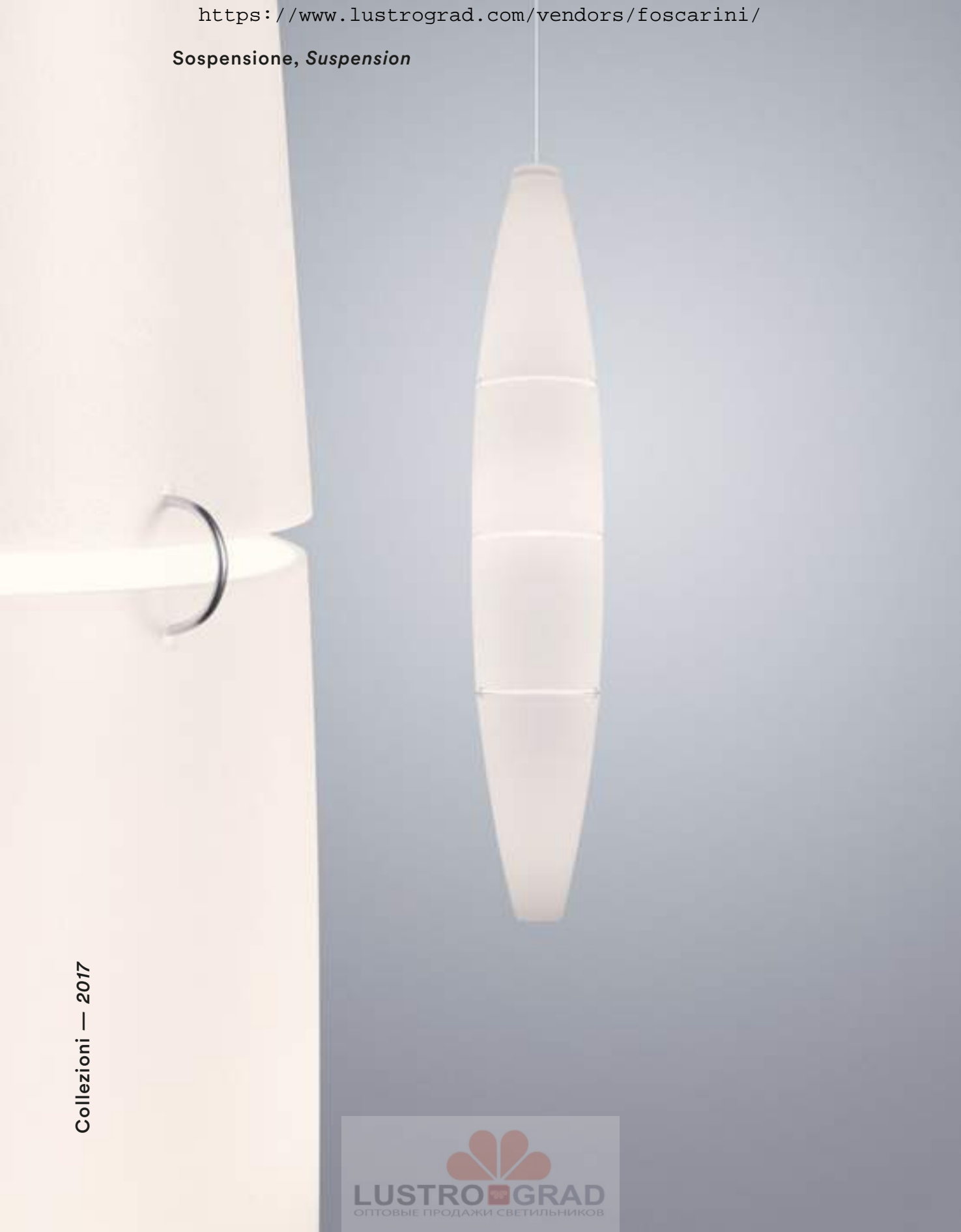

Collezioni — 2017

Havana

Joseph Forakis, 1993

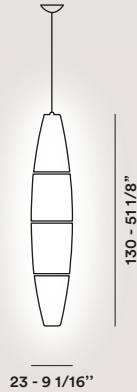

Polietilene stampato a iniezione
e metallo verniciato.
*Injection moulded polyethylene
and varnished metal.*

220 / 240V: halo 1x105W E27,
fluo o LED retrofit 1x25W E27
120V: inc 1x100W E26,
fluo or LED retrofit 1x25W E26
Energy class A+, A, C



Bianco. *White.*



collection →

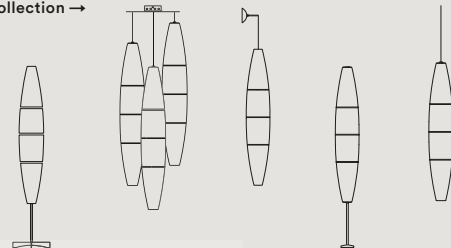

p. 106

p. 277

p. 352

p. 382

p. 380

Sospensione, *Suspension*



Collezioni — 2017

Jamaica

Marc Sadler, 2011

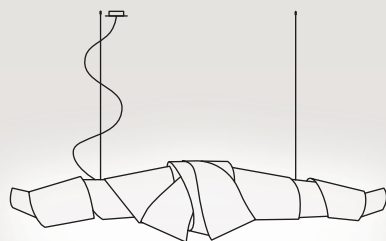

180 - 70 7/8"

35 - 13 3/8"

Carta accoppiata con tecnopolimero,
PMMA e metallo verniciato.
*Paper tape coupled with techopolymer,
PMMA and varnished metal.*

220 / 240V: fluo max 2x80W G5
120V: fluo 2x80W mini Bi-Pin
Energy class A+, A

Dimmerabile — *Dimmable*

CE   IP 20

Bianco. *White.*



Sospensione, *Suspension*



Collezioni — 2017

Le Soleil

Vicente Garcia Jimenez, 2009

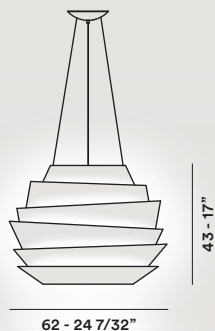

Policarbonato stampato ad iniezione
e metallo verniciato.

*Injection moulded polycarbonate
and coated metal.*

220 / 240V: halo o LED retrofit 3x70W E27

+ halo o LED retrofit 1x75W GU10 PAR

120V: halo or LED retrofit 3x60W E26

+ halo or LED retrofit 1x75W GU10 PAR

Energy class A+, A, C

CE  IP 20 —  (halo)

Bianco, rosso.

White, red.



collection →



Sospensione, *Suspension*



Collezioni — 2017

Lightweight

Tom Dixon, 1995

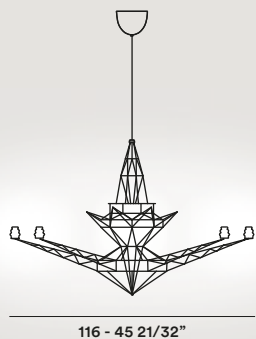

Metallo anodizzato.
Anodised metal.

220 / 240V: halo o LED retrofit 8x20W G4
120V: halo or LED retrofit 8x20W G4
Energy class C

CE  IP 20

Anodizzato. Anodized.

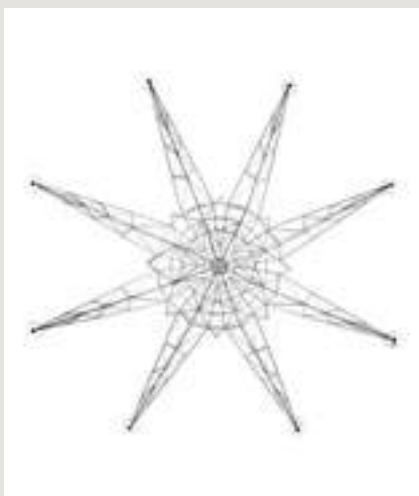

Sospensione, *Suspension*



Collezioni — 2017

Maki

Nendo, 2011



30
11 3/4"

9
3 1/2"

Alluminio verniciato.
Lacquered aluminium.

halo o LED retrofit 1x35W GU10
Energy class A+, A, C

CE   IP 20

Bianco, grigio.
White, grey.



collection →



p. 277

Sospensione, *Suspension*



Collezioni — 2017

O-Space

Luca Nichetto e Gianpietro Gai, 2003



29
11 3/8"

56 - 22"

Poliuretano espanso e metallo cromato.
Expanded polyurethane and chrome metal.

220 / 240V: halo o LED retrofit 1x120W R7s
120V: halo or LED retrofit 1x150W RSC
Energy class A+, A, C

CE  IP 20

Bianco. *White.*



Sospensione, *Suspension*



Collezioni — 2017

Planet

Changedesign, 2011

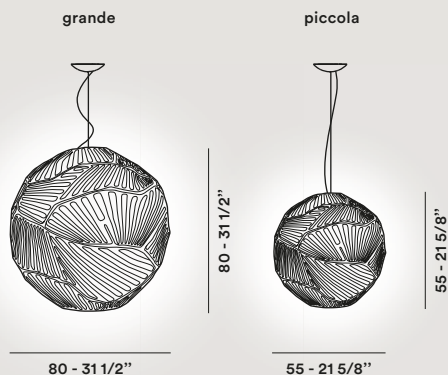

Polietilene tereftalato e nylon.
Polyethylene terephthalate and nylon.

Planet grande
220 / 240V: halo 1x150W E27,
fluo o LED retrofit 1x25W E27
120V: halo 1x150W E26,
fluo or LED retrofit 1x26W E26
Energy class A+, A, C

Planet piccola
220 / 240V: halo 1x105W E27,
fluo o LED retrofit 1x25W E27
120V: halo 1x100W E26,
fluo or LED retrofit 1x26W E26
Energy class A+, A, C

CE    IP 20

Bianco. *White.*

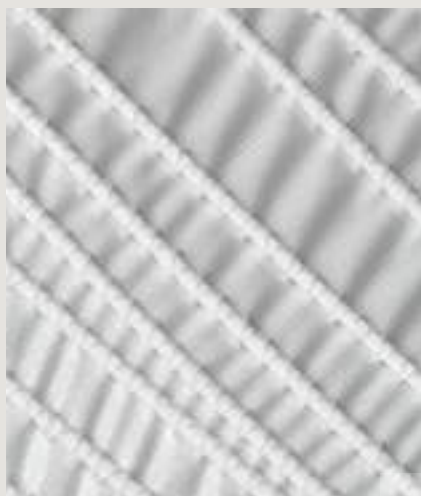

Sospensione, *Suspension*



Collezioni — 2017

Plass grande

Luca Nichetto, 2011



Policarbonato stampato in rotazionale e alluminio.

Rotational moulded polycarbonate and aluminium.

LED 30W 3000° K 2500 lm CRI>80
1x9,5W E27 PAR LED retrofit 650 lm CRI>80
Energy class A+, A

220 / 240V: halo o LED retrofit 6x60W G9
+ halo o LED retrofit 1x100W E27
120V: halo or LED retrofit 6x60W G9
halo or LED retrofit 1x75W E26
Energy class A+, A, C



Grigio, azzurro.
Grey, blue.

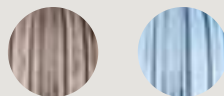

collection →

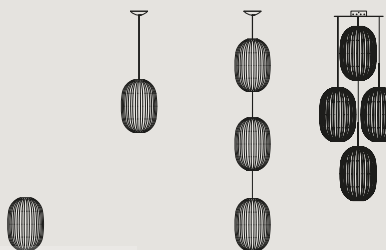

p. 070

p. 228

p. 228

p. 284

Sospensione, *Suspension*



Collezioni — 2017

Plass media

Luca Nichetto, 2015



Policarbonato stampato in rotazionale e acciaio.

Rotational moulded polycarbonate and steel.

220 / 240V: halo o LED retrofit 1x116W E27

+ halo o LED retrofit 1x75W GU10

120V: halo or LED retrofit 1x100W E26

+ halo or LED retrofit 1x50W GU10

Energy class A+, A, B, C



Grigio, azzurro.

Grey, blue.

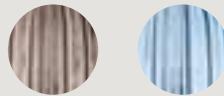

collection →

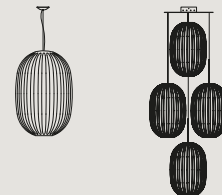

p. 070

p. 226

p. 284

Sospensione, *Suspension*



Collezioni — 2017

Rituals

Ludovica + Roberto Palomba, 2013

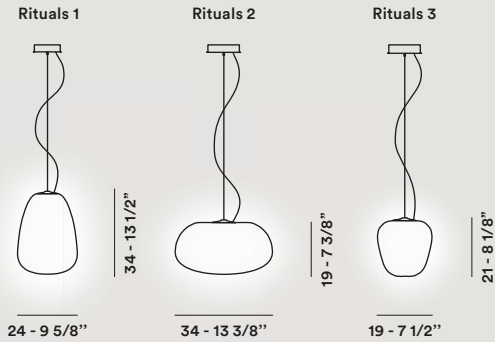

Vetro soffiato satinato inciso e metallo verniciato.
Blown engraved satin glass and lacquered metal.

220 / 240V: fluo o LED retrofit 1x15W E27
halo 1x70W E27
120V: fluo or LED retrofit 1x15W E26
halo 1x60W E26
Energy class A+, A, C

CE  IP 20

Bianco. *White.*



collection →

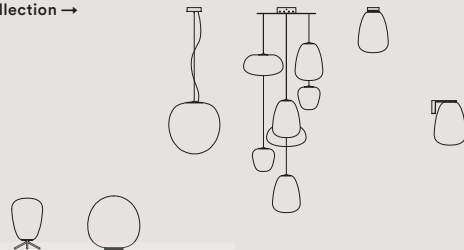

p. 074

p. 080

p. 232

p. 283

p. 314

p. 366

Sospensione, *Suspension*



Collezioni — 2017

Rituals XL

Ludovica + Roberto Palomba, 2015

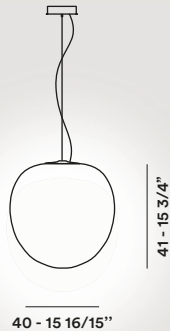

Vetro soffiato satinato inciso e metallo verniciato.
Blown engraved satin glass and lacquered metal.

220 / 240V: LED 24W 2700° K 2676 lm CRI>90
120V: 23W 2700° K 2291 lm CRI>90
Energy class A+
Dimmerabile — *Dimmable*

220 / 240V: halo 1x150W E27,
fluo o LED retrofit 1x25W E27
120V: halo 1x100W E26,
fluo or LED retrofit 1x26W E26
Energy class A+, A, C



Bianco. *White.*



collection →

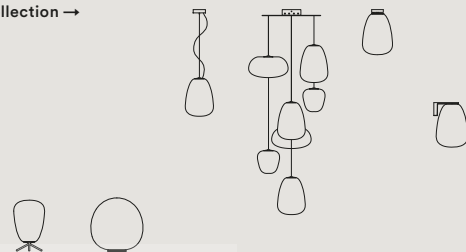

p. 074

p. 080

p. 230

p. 283

p. 314

p. 360

Stories



Collezioni — 2017

Lampada da sospensione — *Suspension lamp*



Spokes

Garcia Cumini, 2015

Spokes nasce dall'osservazione dei raggi di una ruota da bicicletta. Sottili tondini metallici che soddisfano una funzione precisa, ma al tempo stesso rappresentano delle linee grafiche in movimento. Con un processo di curvatura e ripetizione di questi segni, nasce una forma morbida e leggera, simile a una lanterna orientale o ad una voliera per uccelli.

Spokes comes from observation of the spokes of a bicycle wheel. Slender metal rods that have a precise function, but at the same time represent graphic lines in motion. Through a process of curvature and repetition of these signs, a soft, light form emerges, similar to an oriental lantern or a birdcage.

Scenographic volume

Stories

Spokes — Garcia Cumini, 2015

All'interno di questa struttura sospesa, una speciale doppia scheda LED, sviluppata da Foscarini, illumina lo spazio sottostante e l'ambiente tutto attorno, con una luce calda e solare che filtra verso l'esterno, generando giochi di pieni, vuoti ed ombre, in un magico e geometrico reticolo.

Inside this suspended structure a special dual LED circuit, developed by Foscarini, lights the space below and the surrounding zone with warm, sunny light that filters outward, generating effects of fullness, emptiness and shadows, in a magical geometric grid.



Light and shadows





Abbinando diverse forme, colori e dimensioni, è possibile creare un'infinità di situazioni visive e luminose, con trame visive che si proiettano nello spazio domestico o collettivo. La famiglia Spokes comprende la versione Spokes L, ancora più grande e scenografica, ideale per gli ambienti di ampie dimensioni e con un alto soffitto.

By combining different forms, colours and sizes, it is possible to create infinite visual and luminous situations, with visual patterns projected into domestic or public space. The Spokes family includes the Spokes L version, even larger and more dramatic, ideal for large areas or rooms with high ceilings.

Textes en français, deutsche Texte, textos en español → p. 400

Magic

Sospensione, *Suspension*



Collezioni — 2017

Spokes

Garcia Cumini, 2015



Spokes 1



32,5 - 12 3/4"

Spokes 2



52 - 20 1/2"

71 - 28"

52,5 - 20 5/8"

Acciaio e alluminio verniciato.
Varnished steel and aluminium.

220 / 240V: LED 38W 2700° K 3264 lm CRI>90
120V: LED 40W 2700° K 3036 lm CRI>90
Dimmerabile — *Dimmable*
Energy class A+



Bianco, giallo.
White, yellow.

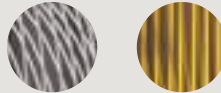

collection →



Sospensione, *Suspension*



Collezioni — 2017



Sospensione, *Suspension*



Collezioni — 2017

Spokes 2 Large

Garcia Cumini, 2016

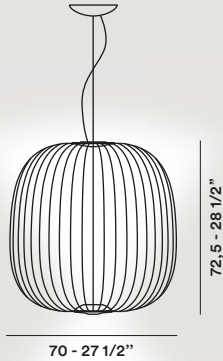

Acciaio e alluminio verniciato.
Varnished steel and aluminium.

220 / 240V: LED 38W 2700° K 3264 lm CRI>90

120V: LED 40W 2700° K 3036 lm CRI>90

Dimmerabile — *Dimmable*

Energy class A+



Bianco, giallo.

White, yellow.

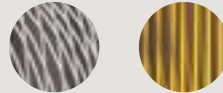

collection →



Sospensione, *Suspension*

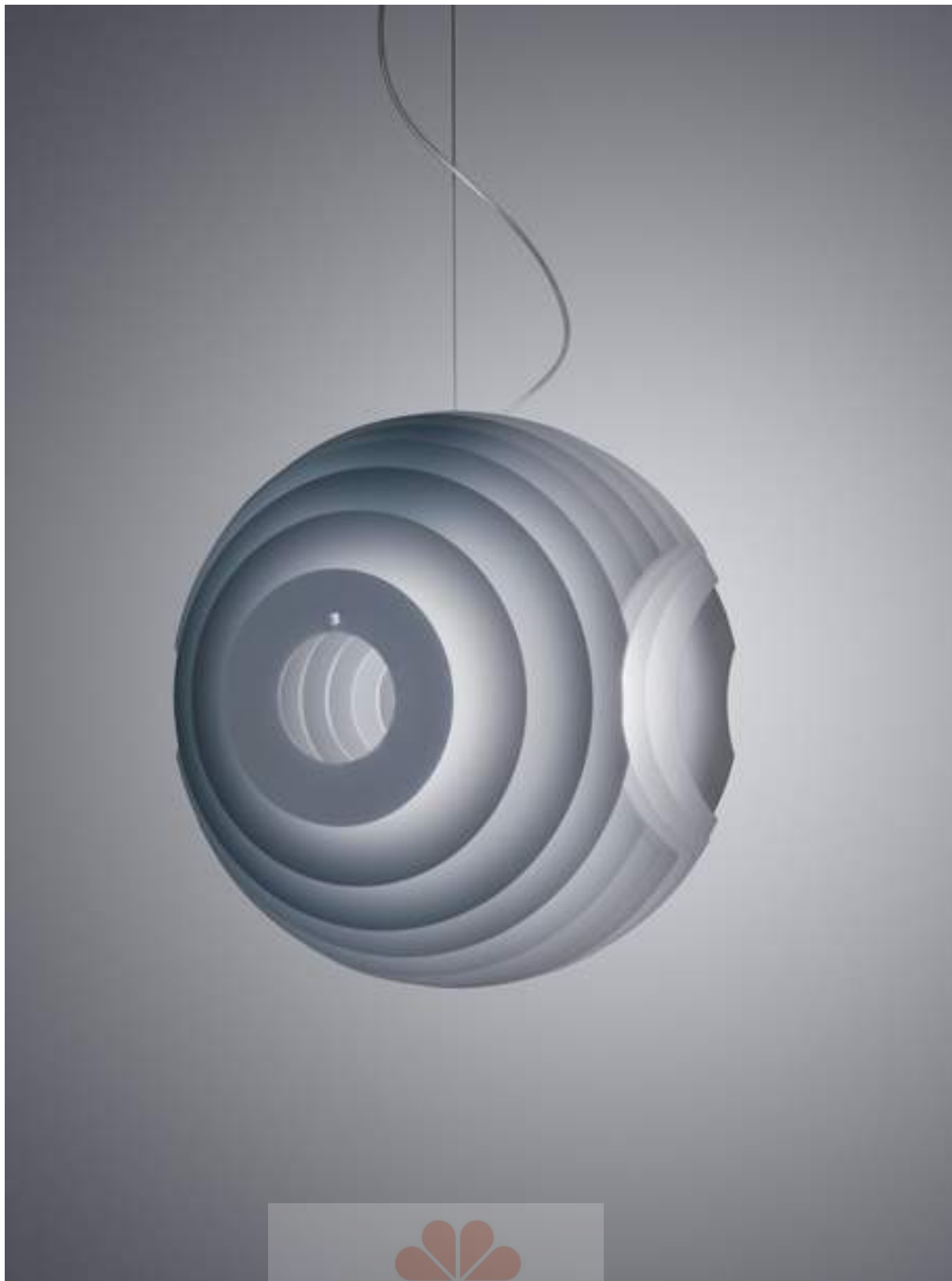

Collezioni — 2017

Supernova

Ferruccio Laviani, 2000



Alluminio verniciato.
Lacquered aluminium.

220 / 240V: fluo o LED retrofit 1x23W E27
120V: inc, fluo or LED retrofit 1x100W E26
Energy class A+, A, C

Raccomandata lampadina a globo bianco Ø 12cm.
White globe bulb recommended Ø 12 cm.

CE  IP 20

Alluminio, fucsia.
Aluminium, fuchsia.

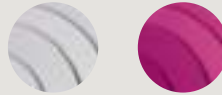

Stories



Collezioni — 2017

Lampada da sospensione — *Suspension lamp*

Tartan

Ludovica + Roberto Palomba, 2015



Il tartan è l'inconfondibile disegno dei tessuti di lana dei kilt scozzesi, un incrocio perpendicolare di linee che genera motivi geometrici sempre diversi. Partendo da questa ispirazione, Ludovica e Roberto Palomba hanno creato insieme a Foscarini un'ulteriore variazione sul tema della lampada in vetro soffiato, proseguendo un percorso iniziato nel 1998 con il modello Dom e continuato con la famiglia delle lampade Rituals.

Tartan is the unmistakable design characteristic of Scottish woollen kilts with its perpendicular criss cross pattern generating ever changing geometric motifs. With this to inspire them Ludovica and Roberto Palomba, together with Foscarini, created a further variation on the blown glass lamp theme continuing a journey begun in 1998 with the Dom model and then with the Rituals lamp family.

Pattern

Stories

Tartan — Ludovica + Roberto Palomba, 2015

Nella lampada a sospensione Tartan, grazie alla tecnica della soffiatura a bocca all'interno di uno stampo con particolari incisioni, il diffusore in vetro soffiato si arricchisce di linee e pieghe che ricordano la trama del tessuto scozzese, generando un gioco grafico fatto di luci ed ombre. La tecnica dell'acidatura della superficie vetrosa offre poi una sensazione di morbidezza materica che richiama il tessuto.

The Tartan suspension lamp has a blown glass diffuser made using the technique of mouth blowing into a mould with a design engraved in it, enriching it with lines and folds echoing the weave of Scottish cloth and a graphic play of light and shadow. The acid etching technique used on the surface of the glass also produces a sensation of material softness which brings fabric to mind.

Sophisticated glass



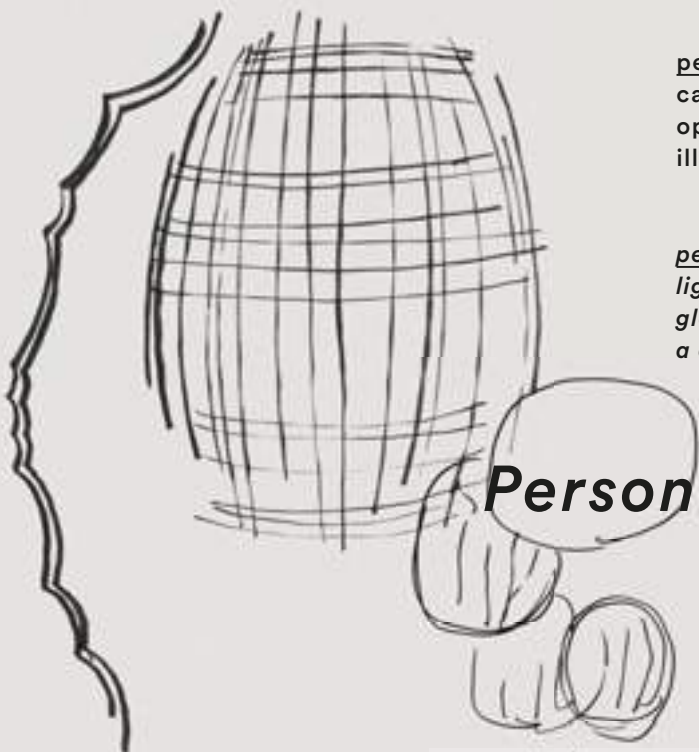

Ricca nel materiale e affascinante nella personalità, Tartan diffonde una luminosità calda e soffusa nell'ambiente, filtrata dal vetro opacizzato, e garantisce anche una buona illuminazione diretta verso il basso.

Materially rich with an attractive personality, Tartan diffuses a warm, suffused light into the environment filtered with matt glass and also ensures good direct lighting in a downwards direction.

Textes en français, deutsche Texte, textos en español → p. 401

Personality

Sospensione, *Suspension*



Collezioni — 2017

Tartan

Ludovica + Roberto Palomba, 2015



Vetro soffiato in rilievo e acidato.
Blown acid-etched glass with reliefs.

220 / 240V: LED 24W 2700° K 2676 lm CRI>90
120V: 23W 2700° K 2291 lm CRI>90
Energy class A+
Dimmerabile — *Dimmable*

220 / 240V: halo 1x150W E27,
LED retrofit o fluo 1x25W E27
120V: halo 1x150W E26,
LED retrofit or fluo 1x26W E26
Energy class A+, A, C



Bianco, grigio.
White, grey.

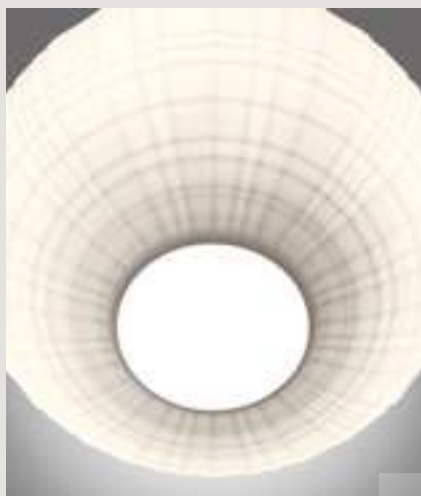

collection →



p. 279

Sospensione, *Suspension*



Collezioni — 2017

Tite

Marc Sadler, 2000

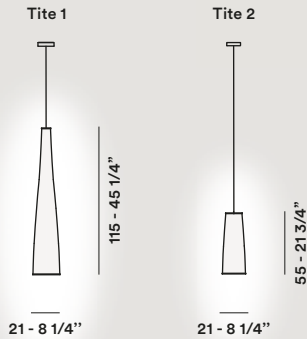

Tessuto di vetro, fibra di carbonio
e acciaio nichelato.
*Fiberglass fabric with carbonium thread
and nickel-plated steel.*

220 / 240V: halo 1x116W E27,
fluo o LED retrofit 1x25W E27
120V: inc 1x100W E26,
fluo or LED retrofit 1x26W E26
Energy class A+, A, C

CE  IP 20

Nero. Black.



collection →

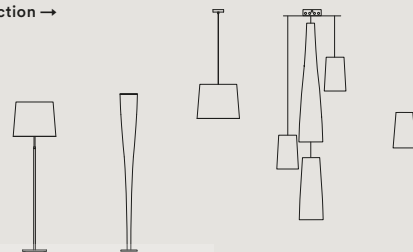

p. 102

p. 118

p. 208

p. 282

p. 356

Sospensione, *Suspension*



Collezioni — 2017

Tress

Marc Sadler, 2009

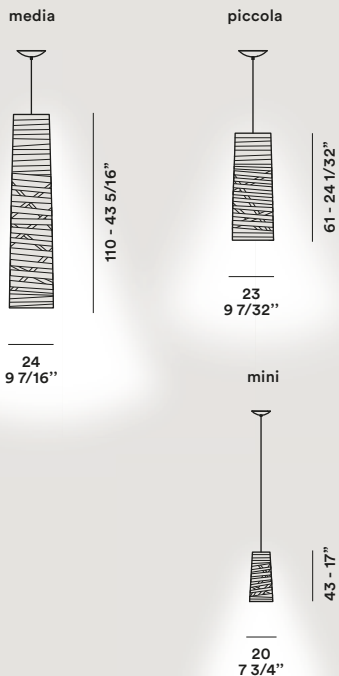

Materiale composito su base di fibra di vetro verniciato e metallo cromato.
Varnished fibreglass based composite material and chromed metal.

Tress media / piccola
220 / 240V: LED retrofit o fluo 1x12W E27 PAR
halo 1x100W E27 PAR
120V: LED retrofit or fluo 1x12W E26 PAR
halo 1x75W E26 PAR

Tress mini
220 / 240V: LED retrofit o fluo 1x8W GU10
halo 1x75W GU10
120V: LED retrofit or fluo 1x8W GU10
halo 1x75W GU10

Energy class A+, A, C

CE IP 20 — (media / piccola)

Bianco, nero, cremisi, greige, indaco.
White, black, crimson, greige, indigo.



collection →

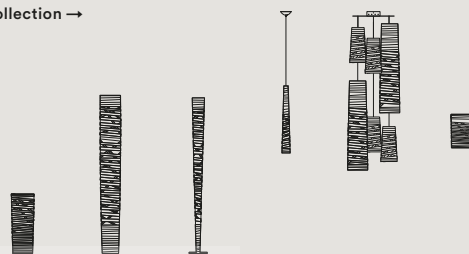

p. 082

p. 132

p. 138

p. 258

p. 279

p. 370

Sospensione, *Suspension*



Collezioni — 2017

Tress grande

Marc Sadler, 2009



Materiale composito su base di fibra di vetro verniciato, vetro soffiato acidato e alluminio.
Coated fibreglass based composite material, blown acid-etched glass and aluminium.

220 / 240V: LED 35W 3000° K 3653 lm CRI>90

120V: LED 47W 3000° K 3653 lm CRI>90

Energy class A+

Dimmerabile — *Dimmable*

220 / 240V: halo o LED retrofit 1x160W R7s

120V: halo or LED retrofit 1x200W RSC

Energy class A+, A, C

Dimmerabile — *Dimmable*

CE IP 20 — (halo)

Bianco, nero, cremisi, greige, indaco.

White, black, crimson, greige, indigo.

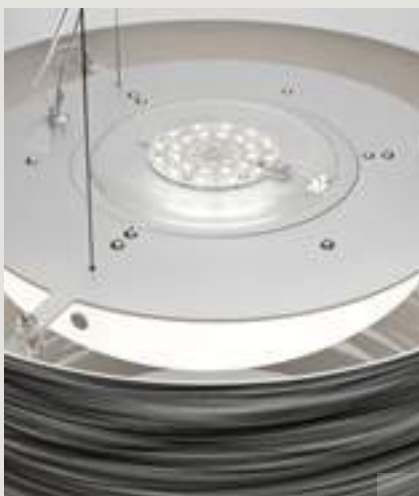

collection →

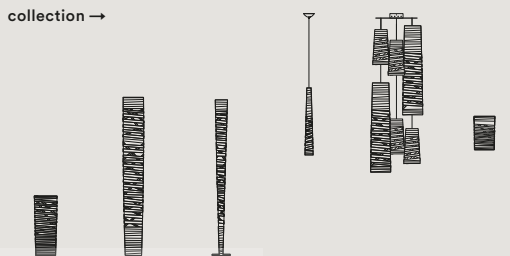

p. 082

p. 132

p. 138

p. 258

p. 279

p. 370

Sospensione, *Suspension*



Collezioni — 2017

Tress Stilo

Marc Sadler, 2011

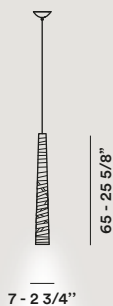

Materiale composito su base di fibra di vetro verniciato, acciaio inox e policarbonato.
Varnished fibreglass based composite material, stainless steel and polycarbonate.

220 / 240V: halo o LED retrofit 1x35W GU10
120V: halo or LED retrofit 1x35W GU10
Energy class A+, A, C

CE  IP 20

Bianco, nero.
White, black.

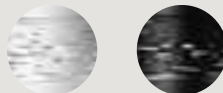

collection →

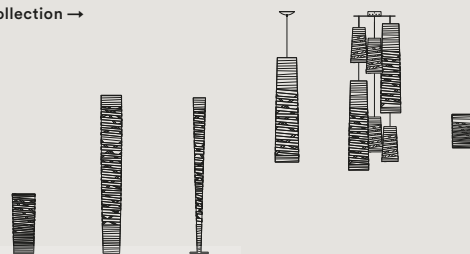

p. 082

p. 132

p. 138

p. 254-256

p. 279

p. 370

Sospensione, *Suspension*

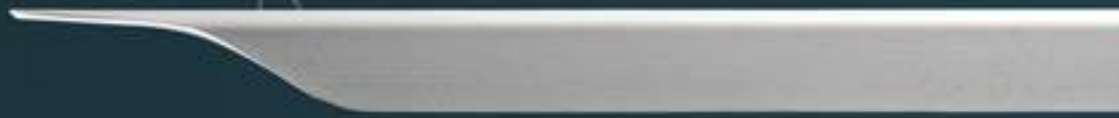

Collezioni — 2017

Troag

Luca Nichetto, 2010

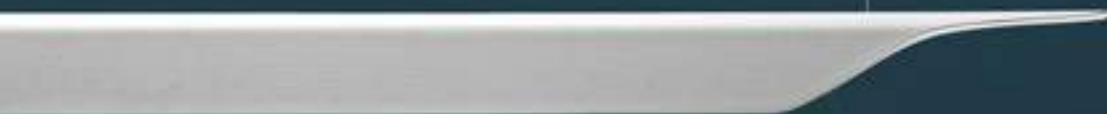

Sospensione, *Suspension*



Collezioni — 2017

Troag

Luca Nichetto, 2010

grande

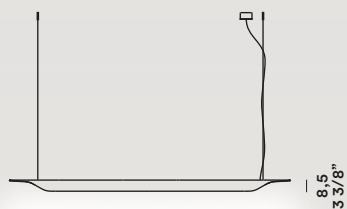

215 - 84 5/8"

media

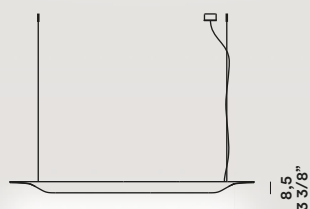

185 - 72 5/8"

piccola

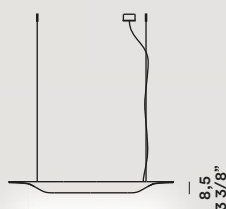

125 - 49 1/8"

Multistrato di legno curvato e PMMA.
Curved plywood and PMMA.

Troag grande

220 / 240 - 120V: fluo 1x80W G5

Troag media

220 / 240 - 120V: fluo 1x54W G5

Troag piccola

220 / 240 - 120V: fluo 1x24W G5

Energy class A+, A



Nero, naturale, bianco.

Black, natural, white.

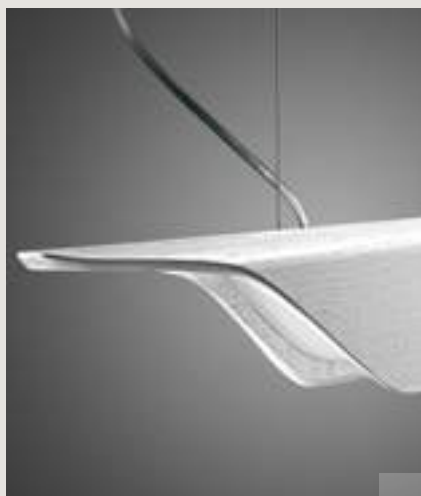

Sospensione, *Suspension*



Collezioni — 2017

Tropico

Giulio Iacchetti, 2008

Vertical

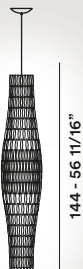

30 - 11 5/6"

Sphera



60 - 23 3/4"

Ellipse



70 - 27 1/2"

Policarbonato stampato a iniezione
e metallo cromato.

*Injection moulded polycarbonate
and chromed metal.*

Tropico Vertical

220 / 240V: fluo 1x40W 2G11

120V: fluo 1x36W 2G11

Energy class A+, A

Tropico Sphera /Ellipse

220 / 240V: fluo 1x42W GX24q-4

120V: fluo 1x42W GX24q-4

Energy class A+, A

A richiesta filtri colorati

— *Colored filters on request*



Ghiaccio. Ice.



Sospensione, *Suspension*



Collezioni — 2017

Twiggy

Marc Sadler, 2007

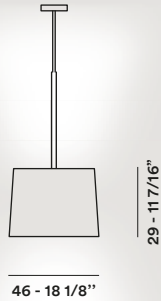

Materiale composito su base di fibra di vetro verniciato, policarbonato, PMMA e acciaio.
Coated fibreglass based composite material, PMMA, polycarbonate and steel.

220 / 240V: halo 3×77W E27,
fluo o LED retrofit 3×20W E27
120V: inc 3×100W E26,
fluo or LED retrofit 3×20W E26
Energy class A+, A, C

CE  IP 20

Bianco, nero.
White, black.



collection →

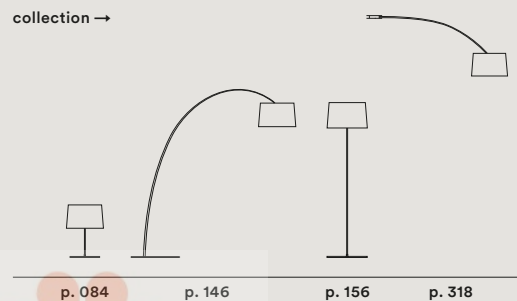

Sospensione, *Suspension*



Collezioni — 2017

Twice as Twiggy

Marc Sadler, 2015

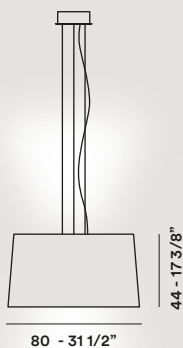

Materiale composito su base di fibra di vetro laccato, PMMA, metallo verniciato e alluminio.

Coated fibreglass-based composite material, PMMA, coated metal and aluminium.

LED 81W 3000° K 8517 lm CRI>90

Energy class A+

Dimmerabile — Dimmable

CE IP 20

Bianco, nero, cremisi, greige, indaco.

White, black, crimson, greige, indigo.

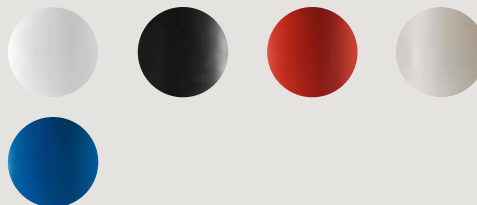

collection →

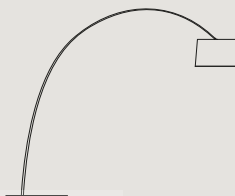

p. 152

Sospensione, *Suspension*



Collezioni — 2017

Uto

Lagranja Design, 2005



64 - 23 5/8"

20 - 7 7/8"

Elastomero termoplastico e policarbonato.
Thermoplastic elastomer and polycarbonate.

220 / 240V: fluo o LED retrofit 1x15W E27

120V: fluo or ED retrofit 1x13W E26

Energy class A+, A

CE □ IP 44

Suitable for damp location

Bianco, giallo, arancio.

White, yellow, orange.



collection →



p. 086



p. 388

Sospensione, *Suspension*

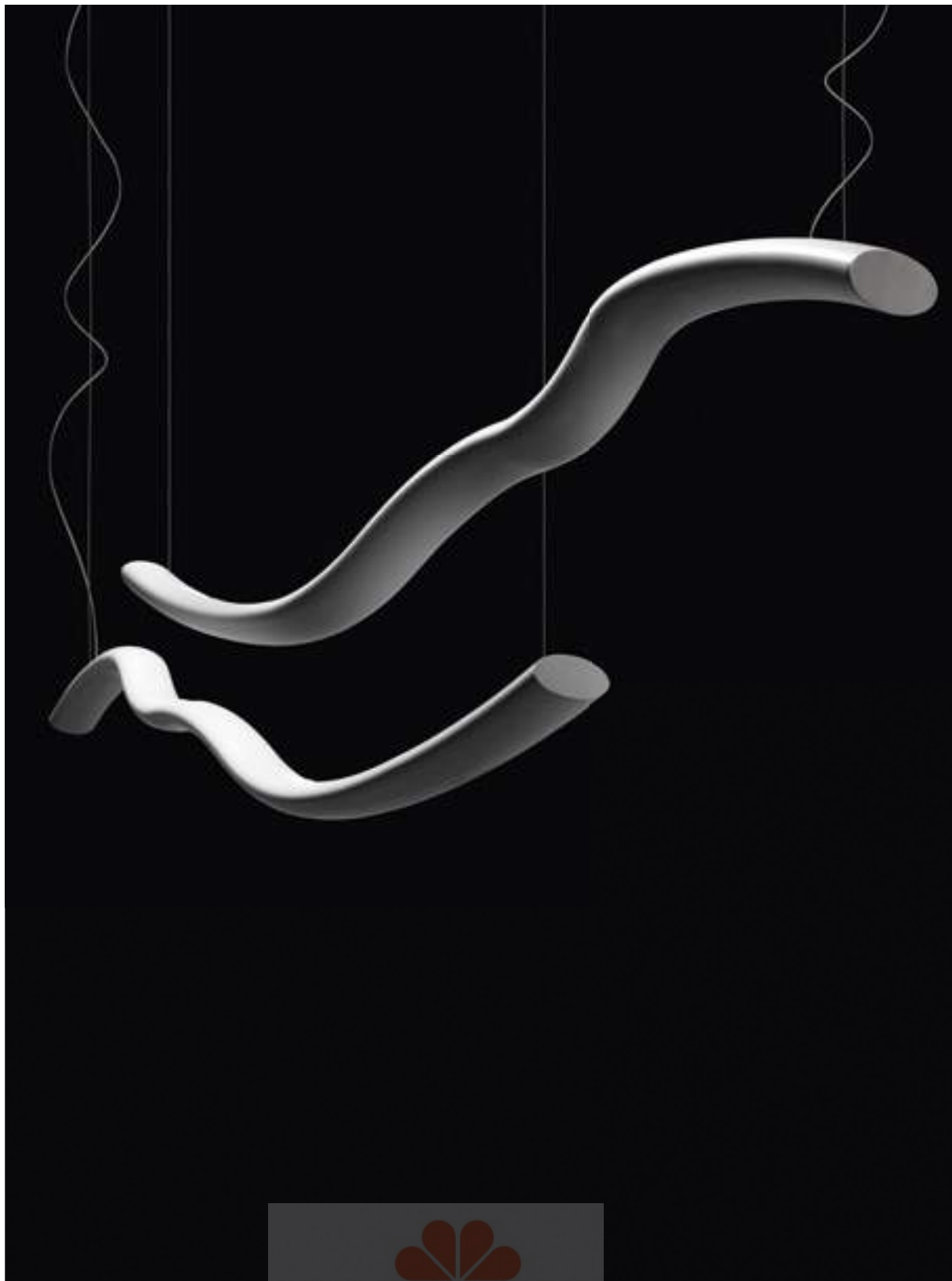

Collezioni — 2017

Wave

Studio Baruffi & De Santi, 2009



228 - 88 1/32"

31 - 10 7/16"

Alluminio laccato.
Lacquered aluminium.

220 / 240V: halo o LED retrofit 3x80W R7s
120V: halo or LED retrofit 3x100W RSC
Energy class A+, A, C

CE   IP 20

Bianco, alluminio.
White, aluminium.





Accessori — Accessories

276 - 279 **Rosone Tondo**
— *Round canopy*

288 - 289 **Kit decentramento —**
Decentralization kit

280 - 287 **Rosone Lineare**
— *Linear canopy*



Accessori, Accessories



Collezioni — 2017

Rosone multiplo tondo

Round multiple canopy

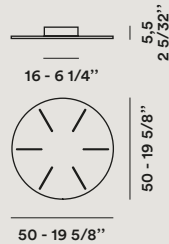

Metallo verniciato. *Laquered metal.*

Aplomb / Aplomb mini → max 9
Birdie grande → max 6
Birdie piccola → max 9
Buds 1 / 2 / 3 → max 6
Caboche piccola → max 6
Caiigo → max 6
Chouchin 1 / 2 / 3 → max 6
Chouchin mini 1 / 2 → max 9
Gregg media → max 6
Gregg piccola → max 9
Havana → max 6
Maki → max 9
Plass media → max 6
Rituals 1 / 2 → max 6
Rituals 3 → max 9
Rituals XL → max 6
Tartan → max 5
Tite 1 / 2 → max 9
Tress media / piccola → max 6
Tress mini / Stilo → max 9

Il massimo si riferisce all'installazione di lampade in composizione sfalsata. Escluse le versioni a LED integrato. *Max refers to installation in staggered composition. Integrated LED version excluded.*



Accessori, Accessories

Rosone multiplo tondo — *Round multiple canopy*

Aplomb



Caboche piccola



Chouchin — Chouchin mini



Gregg piccola



Collezioni — 2017

Rosone multiplo tondo — *Round multiple canopy*

Plass media



Tartan



Tress



Tress Stilo



Accessori, Accessories



Collezioni — 2017

Rosone multiplo lineare L 90 Linear multiple canopy L 35 7/16"

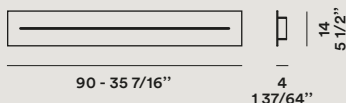

Metallo verniciato. *Laquered metal.*

Aplomb / Aplomb mini → max 6
Birdie grande → max 6
Birdie piccola → max 6
Buds 1 → max 6
Buds 2 → max 4
Buds 3 → max 5
Caboche piccola → max 5
Caiigo → max 6
Chouchin 1 → max 4
Chouchin 2 → max 6
Chouchin 3 → max 5
Chouchin mini 1 / 2 → max 6
Gregg media → max 5
Gregg piccola → max 6
Havana → max 6
Maki → max 6
Plass media → max 5
Rituals 1 → max 6
Rituals 2 → max 5
Rituals 3 → max 6
Rituals XL → max 4
Tartan → max 4
Tite 1 / 2 → max 6
Tress media / piccola → max 6
Tress mini / Stilo → max 6



Il massimo si riferisce all'installazione di lampade in composizione sfalsata. Escluse le versioni a LED integrato. *Max refers to installation in staggered composition. Integrated LED version excluded.*



Accessori, Accessories

Rosone multiplo lineare — *Linear multiple canopy*

Tress



Tite 2



Rosone multiplo lineare — *Linear multiple canopy*

Rituals



Accessori, Accessories



Collezioni — 2017

Rosone multiplo lineare L 135 Linear multiple canopy L 53 5/32''

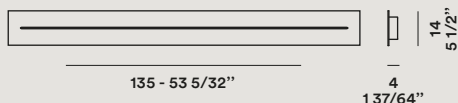

Metallo verniciato. *Laquered metal.*

Aplomb / Aplomb mini → max 9
Birdie grande / piccola → max 9
Buds 1 → max 9
Buds 2 → max 6
Buds 3 → max 8
Caboche piccola → max 8
Caiigo → max 6
Chouchin 1 → max 6
Chouchin 2 → max 9
Chouchin 3 → max 8
Chouchin mini 1 → max 6
Chouchin mini 2 → max 9
Gregg media → max 8
Gregg piccola → max 9
Havana → max 9
Maki → max 9
Plass media → max 8
Rituals 1 → max 9
Rituals 2 → max 7
Rituals 3 → max 9
Rituals XL → max 6
Tartan → max 5
Tite 1 / 2 → max 9
Tress media / piccola → max 9
Tress mini / Stilo → max 9



Il massimo si riferisce all'installazione di lampade in composizione sfalsata. Escluse le versioni a LED integrato. *Max refers to installation in staggered composition. Integrated LED version excluded.*

Accessori, Accessories

Rosone multiplo lineare — *Linear multiple canopy*

Aplomb



Caboche piccola



Tartan



Gregg piccola



Rosone multiplo lineare — *Linear multiple canopy*

Chouchin Reverse



Kit decentramento Decentralization kit



Kit B

Decentramento per funi d'acciaio.

Decentralization for steel cable supports.

Per i modelli — *For the models:* Allegretto, Allegro, Behive, Big Bang, Caboche, Chouchin, Chouchin Reverse, Chouchin mini, Gregg grande / media, Le Soleil, New Buds, O-Space, Planet, Plass, Plass media, Rituals, Rituals XL, Supernova, Tropic, Tress grande / media / piccola.



Kit C

Decentramento per cavo elettrico autoportante.

Decentralization for power cable.



Per i modelli — *For the models:* Aplomb, Giga-Lite, Gregg piccola, Havana, Maki, Tite, Tress mini, Tress stilo, Twiggy.

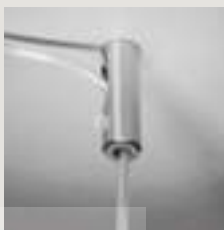



Kit F

Decentramento per funi d'acciaio con rosone, comprende 3 reggifuni e un rosone bianco.

Decentralization for steel cables includes 3 steel cable supports and a white canopy.



Per i modelli — For the models: Allegretto, Allegro, Behive, Big Bang (LED version excluded), Caboche (LED version excluded), Chouchin, Chouchin Reverse, Chouchin mini, Gregg grande / media, Le Soleil, New Buds, O-Space, Planet, Plass, Plass media, Rituals, Supernova, Tropico, Tress grande (LED version excluded) / media / piccola.



Kit M

Rosone per decentramento elettrico, fino a 4 lampade. *Canopy electrical decentralization up to 4 lamps.*



Per i modelli — For the models: Aplomb, Behive, Big Bang (LED version excluded), Caboche (esclusa versione LED), Chouchin, Chouchin Reverse, Chouchin mini, Giga-Lite, Gregg, Havana, Jamaica, Le Soleil, Maki, New Buds, O-Space, Planet, Plass, Plass media, Rituals, Rituals XL, Supernova, Tite, Tress (LED version excluded), Tress Stilo, Troag, Tropico, Twiggy, Wave.





Soffitto — Ceiling

292 **Bahia + Bahia mini**

294 **Big Bang**

296 **Birdie**

298 **Blob S**

300 **Caboche**

302 **Circus**

304 **Ellepi**

306 **Folio**

308 **Gregg**

310 **Lumiere XXL + XXS**

312 **Nuage**

314 **Rituals**

316 **Tivu**

318 **Twiggy**



Soffitto, Ceiling



Collezioni — 2017

Bahia + Bahia mini

Lucidi e Pevere, 2010/2015

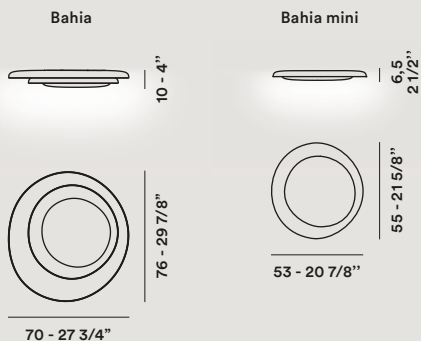

Policarbonato stampato a iniezione.
Injection moulded polycarbonate.

Bahia
LED 43W 2850°K 4210 lm CRI>90
Dimmerabile — *Dimmable*

220 / 240 / 120V: fluo 1x40W
+ 1x22W 2GX13
Energy class A+, A

Bahia mini
LED 21W 2850°K 2425 lm CRI>90
Dimmerabile — *Dimmable*

220 / 240 / 120V: fluo 1x22W 2GX13
Dimmable version available
Energy class A+, A



Bianco. *White.*



collection →



Soffitto, Ceiling



Collezioni — 2017

Big Bang

Enrico Franzolini con Vicente Garcia Jimenez, 2006

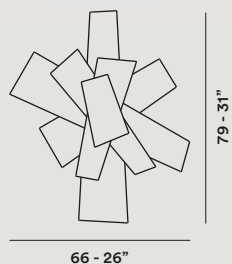

Metacrilato e metallo laccato.
Methacrylate and lacquered metal.

220 / 240V: halo o LED retrofit 1x120W R7s
120V: halo or LED retrofit 1x100W RSC
Energy class A+, A, C

CE  IP 20

Bianco, rosso.
White, red.



collection →

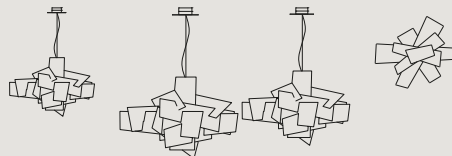

p. 180

p. 186

p. 330

Soffitto, Ceiling



Collezioni — 2017

Birdie

Ludovica + Roberto Palomba, 2012

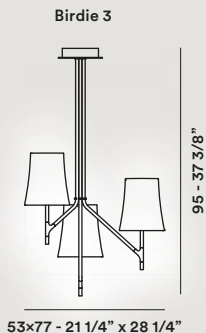

Policarbonato e alluminio verniciato.
Polycarbonate and varnished aluminium.

LED E27/E26

220 / 240V: halo 3-6-9x70W E27,
fluo o LED retrofit 3-6-9x20W E27
120V: 3-6-9x60W E26,
fluo or LED retrofit 3-6-9x20W E26
Energy class A+, A, B, C

Altezze differenti a richiesta — Different
heights on request



Bianco, grigio, arancio, amaranto.
White, gray, orange, amaranth.

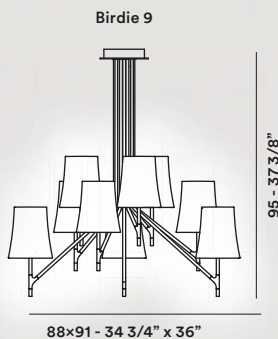
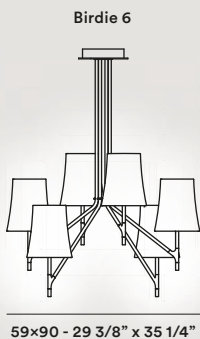

← Birdie 6 e 9 disponibile anche a sospensione — Birdie 6
and Birdie 9 available as suspension version.

collection →

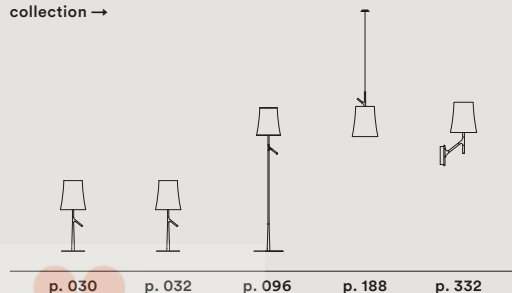

Soffitto, Ceiling



Collezioni — 2017

Blob S

Karim Rashid, 2002

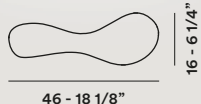

Polietilene stampato a rotazione
e metallo verniciato.

*Rotational moulded polyethylene
and varnished metal.*

220 / 240 / 120V: fluo 1x24W 2G11
Energy class A+, A

CE  IP 20

Bianco. *White.*



collection →



Soffitto, Ceiling



Collezioni — 2017

Caboche

Patricia Urquiola con Eliana Gerotto, 2006



19 - 7 1/2"

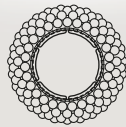

50 - 19 3/4"

Polimetilmetacrilato, vetro soffiato e metallo cromato.

PMMA, blown glass and chromed metal.

220 / 240V: halo o LED retrofit 1x120W R7s

120V: halo or LED retrofit 1x100W RSC

Energy class A+, A, C



Trasparente, giallo oro.

Transparent, gold yellow.

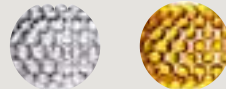

collection →

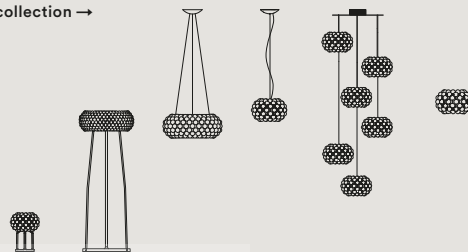

p. 044

p. 098

p. 192

p. 198

p. 278

p. 338

Soffitto, Ceiling



Collezioni — 2017

Circus

Defne Koz, 1994



46 - 18 1/8"



32 - 12 5/8"

Vetro soffiato, metallo verniciato o nichelato.
Blown glass, nickelplated or varnished metal.

Circus grande

220 / 240V: halo 4x46W E27,
fluo o LED retrofit 4x12W E27
120V: inc 4x40W E26,
fluo or LED retrofit 4x13W E26
Energy class A+, A, B, C

Circus piccola

220 / 240V: halo 4x30W E14,
fluo o LED retrofit 4x8W E14
120V: inc 4x25W E12,
fluo or LED retrofit 4x8W E12
Energy class A+, A, B, C

CE  IP 20

Bianco. *White.*



collection →



Soffitto, Ceiling



Collezioni — 2017

Ellepi

Alessandra Matilde, 2003

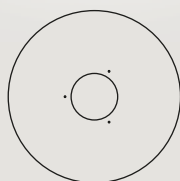

74 - 29 1/8"

Metacrilato e metallo verniciato.
Methacrylate and varnished metal.

220 / 240V: fluo 1x55W 2GX13

120V: fluo 1x40W 2GX13

Energy class A+, A

CE  IP 20

Bianco. *White.*



collection →



p. 344

Soffitto, Ceiling



Collezioni — 2017

Folio

Carlo Urbinati e Alessandro Vecchiato, 1990



10
3 7/8"

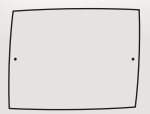

38 - 15"

48 - 18 7/8"

Vetro soffiato satinato e metallo laccato.
Blown acid-etched glass and varnished metal.

220 / 240V: halo o LED retrofit 1x120W R7s,
120V: halo or LED retrofit 1x100W RSC,
Energy class A+, A, C

CE  IP 20

Bianco. *White.*



collection →



Soffitto, Ceiling



Collezioni — 2017

Gregg

Ludovica + Roberto Palomba, 2007

media

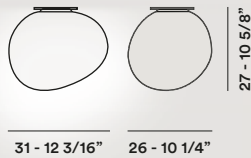

Vetro soffiato acidato e metallo verniciato.
*Blown acid-etched glass and white
lacquered metal.*

Gregg media

220 / 240V: halo 1x150W E27,
fluo o LED retrofit 1x25W E27
120V: halo 1x100W E26,
fluo or LED retrofit 1x26W E26
Energy class A+, A, B, C

piccola

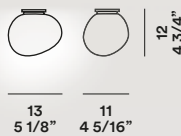

Gregg piccola

220 / 240V: halo o LED retrofit 1x20W G9
120V: halo or LED retrofit 1x25W G9
Energy class A+, A, C

CE  IP 20

Bianco. *White.*



collection →

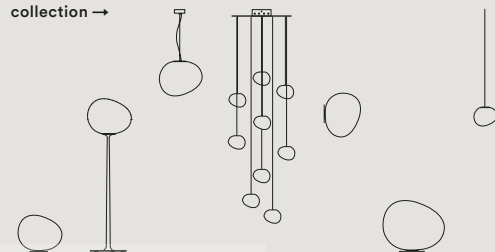

p. 050 p. 104 p. 210 p. 286 p. 350 p. 378 p. 376

Soffitto, Ceiling



Collezioni — 2017

Lumiere XXL + XXS

Rodolfo Dordoni, 2010

Lumiere XXL

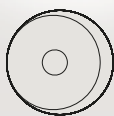

34 - 13 3/8"

Lumiere XXS



25 - 9 5/8"

Vetro soffiato e metallo laccato.
Blown glass and lacquered metal.

Lumiere XXL

220 / 240V: fluo 1x40W + 1x22W 2GX13,
fluo 1x55W dimmerabile *dimmable* 2GX13
120V: fluo 1x40W 2GX13

Energy class A+, A

Lumiere XXS

220 / 240V: fluo 2x18W G24q-2
120V: fluo 2x18W G24q-2

Energy class A+, A

CE  IP 20 —  (XXS)

Bianco. *White.*



collection →



p. 066

p. 114

p. 362

Soffitto, Ceiling



Collezioni — 2017

Nuage

Philippe Nigro, 2012

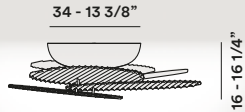

16 - 16 1/4"

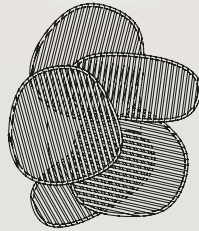

54 - 21 1/2"

Policarbonato stampato a iniezione
e ABS masterizzato.
*Injection-moulded polycarbonate
and batch-dyed ABS.*

Utilizzabile in composizione — *Usable
in composition*

220 / 240V: fluo 1x40W + 1x22W 2GX13
fluo 1x55W dimmerabile *dimnable* 2GX13
120V: fluo 1x40W
Energy class A+, A

CE  IP 20

Bianco, rosso.
White, red.



collection →

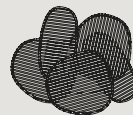

p. 364

Soffitto, Ceiling



Collezioni — 2017

Rituals

Ludovica + Roberto Palomba, 2015

Rituals 1



Rituals 2

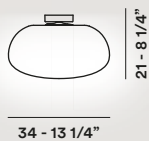

Rituals 3



Vetro soffiato satinato inciso
e metallo verniciato.
*Blown engraved satin glass
and lacquered metal.*

220 / 240V: halo 1x70W E27,
fluo o LED retrofit 1x15W E27
120V: halo 1x60W E26,
fluo or LED retrofit 1x15W E26
Energy class A+, A, B, C

CE  IP 20

Bianco. *White.*



collection →

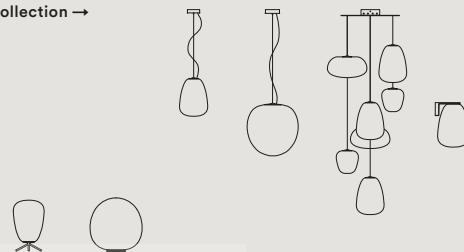

p. 074

p. 080

p. 230

p. 232

p. 283

p. 366

Soffitto, Ceiling



Collezioni — 2017

Tivu

Joseph Forakis, 2011

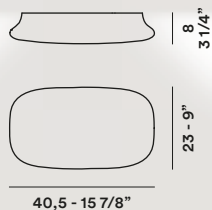

Policarbonato stampato a iniezione.
Injection moulded polycarbonate.

220 / 240 / 120V: fluo 2x18W 2G11
Energy class A+, A

CE  IP 20

Bianco, nero.
White, black.



collection →



p. 368

Soffitto, Ceiling



Collezioni — 2017

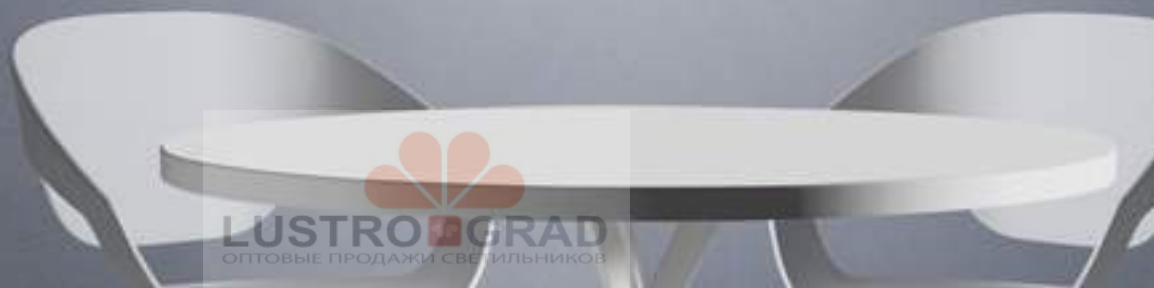

Twiggy

Marc Sadler, 2007

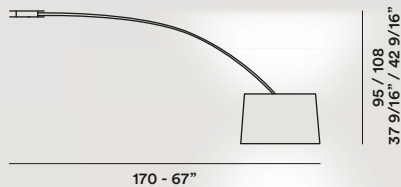

Materiale composito su base di fibra di vetro verniciato, policarbonato, PMMA e metallo verniciato.

Coated fibreglass based composite material, PMMA, polycarbonate and varnished metal.

220 / 240V: halo 3x77W E27,
fluo o LED retrofit 3x20W E27
120V: inc 3x100W E26,
fluo or LED retrofit 3x20W E26
Energy class A+, A, B, C

Girevole a 330° — *Rotating 330°*

☐ CE ♻️ IP 20

Bianco, nero.
White, black.



collection →

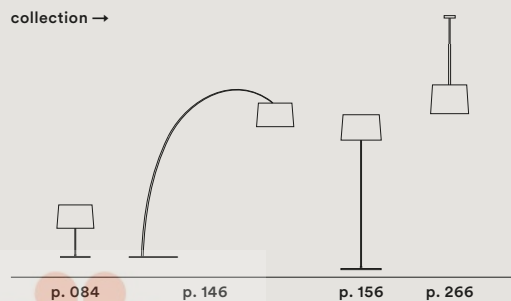



Parete — Wall

- | | | | |
|-----|-------------------|-----|--------------------------|
| 322 | Aplomb | 350 | Gregg |
| 324 | Bahia | 352 | Havana |
| 328 | Bahia mini | 354 | Innerlight |
| 330 | Big Bang | 356 | Kite |
| 332 | Birdie | 358 | Lake |
| 334 | Bit | 360 | Le Soleil |
| 336 | Blob S | 362 | Lumiere XXL + XXS |
| 338 | Caboche | 364 | Nuage |
| 340 | Circus | 366 | Rituals |
| 342 | Double | 368 | Tivu |
| 344 | Ellepi | 370 | Tress |
| 346 | Fields | 372 | Tutù |
| 348 | Folio | | |



Parete, *Wall*



Collezioni — 2017

Aplomb

Lucidi e Pevere, 2014



30 - 11 3/4"



15 - 6"

24
9 1/2"

Cemento, metallo verniciato e alluminio.
Concrete, varnished metal and aluminium.

LED 13W 2700°K 1120 lm CRI>80
Energy class A+

CE IP 20

Bianco, grigio cemento, marrone.
White, concrete grey, brown.



collection →

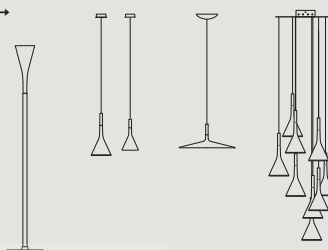

p. 094

p. 168

p. 174

p. 278

Stories



Collezioni — 2017

Lampada da parete e soffitto — *Wall and ceiling lamp*

Bahia

Lucidi e Pevere, 2010

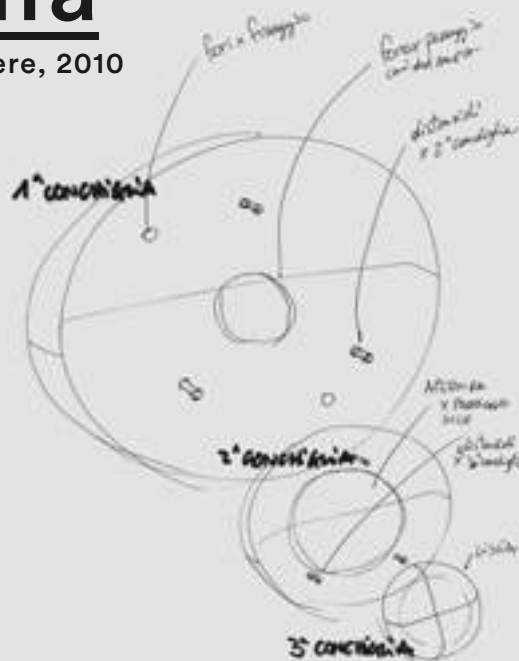
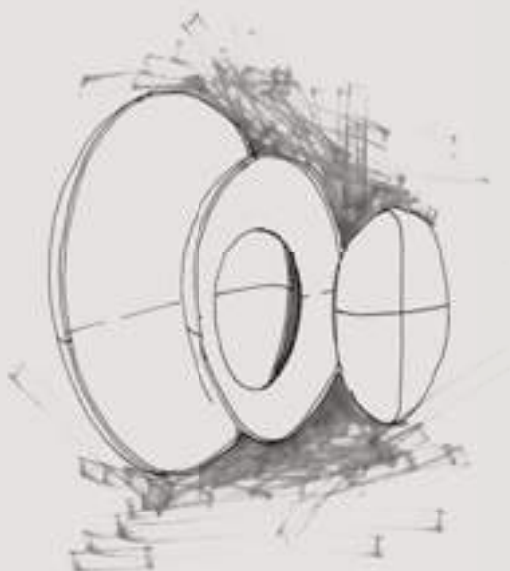

Bahia, affascinante eleganza. Illuminare ed al tempo stesso arredare un ambiente, con una presenza morbida, poetica e infinitamente affascinante: questa è la seducente promessa di Bahia. Un'armonia di luci e ombre, generata dalla semplice sovrapposizione di tre diffusori, disposti seguendo una studiata asimmetria ed alternanza di superfici concave e convesse, in una forma che ricorda un'isola vista dall'alto.

Bahia, charming elegance. Lighting while at the same time decorating a setting, with a soft, poetic and infinitely charming presence: this is the seductive promise made by Bahia. A harmony of lights and shadows generated by the simple overlapping of three diffusers, arranged according to a purpose-devised asymmetry and alternating concave and convex surfaces, in a shape that recalls an island seen from above.

Poetic

Stories



Bahia — Lucidi e Pevere, 2010



Completamente bianca, pura ed assoluta, capace di coprire un'area ampia ma con uno spessore minimo, Bahia assume una sensazionale profondità visiva, grazie ai bagliori concentrici che emanano da essa, riflettendosi sulla parete e diffondendosi nello spazio circostante.

Completely white, pure and absolute, capable of covering a large surface yet with a minimal thickness, Bahia assumes a sensational visual depth, thanks to the concentric glows it casts, which are reflected on the wall and diffused into the surroundings.

Reflections



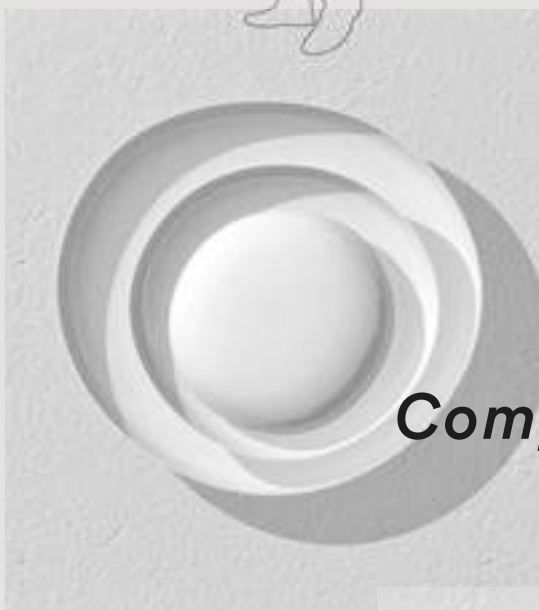

Da sola o in composizioni multiple,
anche con orientamenti diversi per creare
giochi grafici, Bahia diffonde in qualsiasi
spazio un'originale emozione e un'affascinante
illuminazione.

Used alone or in multiple compositions,
also pointing in different directions to create
graphic games, Bahia creates an original feel by
casting a charming light into any room.

Textes en français, Deutsche Texte, Textos en español → p. 393

Compositions



Parete, *Wall*



Collezioni — 2017

Bahia + Bahia mini

Lucidi e Pevere, 2010/2015



Bahia

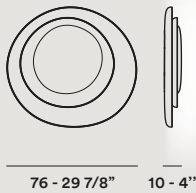

Bahia mini

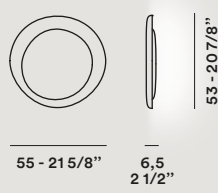

Policarbonato stampato a iniezione.
Injection moulded polycarbonate.

Bahia
LED 43W 2850°K 4210 lm CRI>90
Dimmerabile — *Dimmable*

220 / 240 / 120V: fluo 1x40W
+ 1x22W 2GX13
Energy class A+, A

Bahia mini
LED 21W 2850°K 2425 lm CRI>90
Dimmerabile — *Dimmable*

220 / 240 / 120V: fluo 1x22W 2GX13
Dimmable version available
Energy class A+, A



Bianco. *White.*



collection →



Parete, *Wall*



Collezioni — 2017

Big Bang

Enrico Franzolini con Vicente Garcia Jimenez, 2006

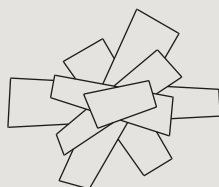

79 - 31"



23 - 9"

66 - 26"

Metacrilato e metallo laccato.
Methacrylate and lacquered metal.

220 / 240V: halo o LED retrofit 1x120W R7s
120V: halo or LED retrofit 1x100W RSC
Energy class A+, A, C

CE    IP 20

Bianco, rosso.
White, red.



collection →



p. 180

p. 186

p. 294

Parete, Wall



Collezioni — 2017

Birdie

Ludovica + Roberto Palomba, 2012



17 - 6 3/4"



24 - 9 1/2"

42 - 16 3/4"

Polycarbonato, acciaio e metallo verniciato.
Polycarbonate, varnished steel and metal.

LED E27/E26

220 / 240V: halo 1x70W E27,
fluo o LED retrofit 1x25W E27
220/240V touch dimmer version available
120V: halo 1x60W E26,
fluo or LED retrofit 1x20W E26
Energy class A+, A, B, C

CE    IP 20

Bianco, grigio, arancio, amaranto.
White, grey, orange, amaranth.



collection →

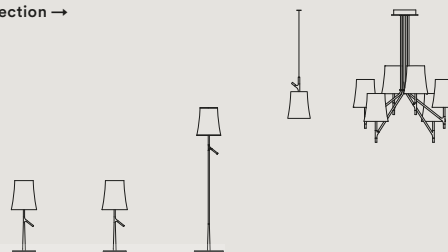

p. 030

p. 032

p. 096

p. 188

p. 296

Parete, Wall



Collezioni — 2017

Bit

Ferruccio Laviani, 1993

Bit 1



Bit 2

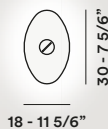

Bit 3

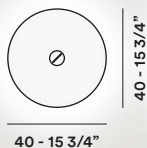

Bit 4

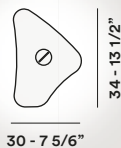

Bit 5



Vetro serigrafato e metallo verniciato.
Silkscreen-printed glass and lacquered metal.

220 / 240V: halo 1x46W E14,
fluo o LED retrofit 1x12W E14
120V: inc 1x60W E12,
fluo or LED retrofit 1x13W E12
Energy class A+, A, B, C



Bianco, colorato (1 rosso, 2 blu, 4 verde, 5 arancio).
White, colored (1 red, 2 blue, 4 green, 5 orange).



collection →



Parete, *Wall*



Collezioni — 2017

Blob S

Karim Rashid, 2002

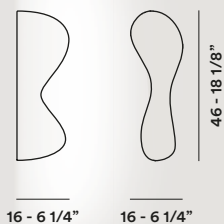

Polietilene stampato a rotazione
e metallo verniciato.
Rotational moulded polyethylene
and varnished metal.

220 / 240 / 120V: fluo 1x24W 2G11
Energy class A+, A

CE  IP 20

Bianco. *White.*



collection →



Parete, Wall



Collezioni — 2017

Caboche

Patricia Urquiola con Eliana Gerotto, 2006

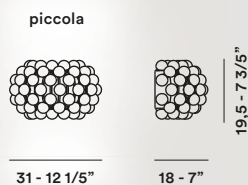
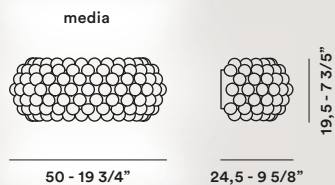

Polimetilmetacrilato, vetro soffiato e metallo cromato.

PMMA, blown glass and chromed metal.

220 / 240V: halo o LED retrofit 1x120W R7s

120V: halo or LED retrofit 1x100W RSC

Energy class A+, A, C



Trasparente, giallo oro.

Transparent, gold yellow.

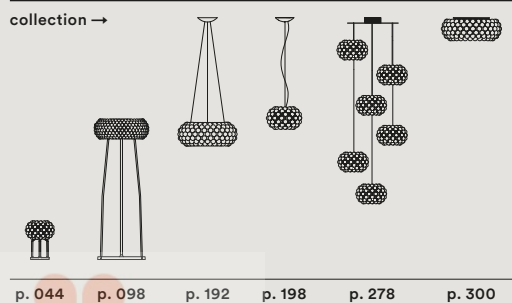
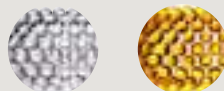

Parete, *Wall*



Collezioni — 2017

Circus

Defne Koz, 1994

grande

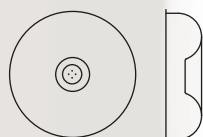

46 - 18 1/8"

13
5 1/8"

piccola



32 - 12 5/8"

12
4 3/4"

Vetro soffiato, metallo verniciato o nichelato.
Blown glass, nickelplated or varnished metal.

Circus grande

220 / 240V: halo 4x46W E27,
fluo o LED retrofit 4x12W E27
120V: inc 4x40W E26,
fluo or LED retrofit 4x13W E26
Energy class A+, A, B, C

Circus piccola

220 / 240V: halo 4x30W E14,
fluo o LED retrofit 4x8W E14
120V: inc 4x40W E12,
fluo or LED retrofit 4x8W E12
Energy class A+, A, B, C

CE    IP 20

Bianco. *White.*



collection →



Parete, *Wall*



Collezioni — 2017

343

Double

Valerio Bottin, 1996



26 - 10 1/4"



24 - 9 1/2"

13 - 5 1/2"

Vetro soffiato e metallo verniciato.
Blown glass and varnished metal.

220 / 240V: halo 2x77W E27,
fluo o LED retrofit 2x20W E27

120V: inc 2x100W E26,
fluo or LED retrofit 2x20W E26

Energy class A+, A, B, C



Bianco, avorio.

White, ivory.



LUSTROGRAD
ОПТОВЫЕ ПРОДАЖИ СВЕТИЛЬНИКОВ

Parete, Wall



Collezioni — 2017



345

Ellepi

Alessandra Matilde, 2003

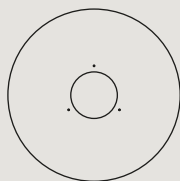

74 - 29 1/8"



6,5
2 1/2"

Metacrilato e metallo verniciato.
Methacrylate and varnished metal.

220 / 240V: fluo 1x55W 2GX13

120V: fluo 1x40W 2GX13

Energy class A+, A



Bianco. *White.*



collection →



p. 304

Parete, Wall



Collezioni — 2017

Fields

Vicente Garcia Jimenez, 2007

Fields 1

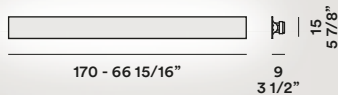

Fields 2

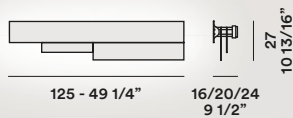

Fields 3

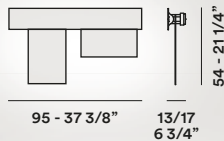

Fields

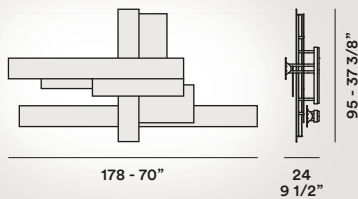

Metacrilato, alluminio verniciato e policarbonato.
Methacrylate, varnished aluminium and polycarbonate.



Anche uso in verticale — *Horizontal and vertical use*

Fields 1
220 / 240 / 120V: fluo 1x80W G5
Energy class A+, A

Fields 2
220 / 240 / 120V: fluo 1x54W G5
Energy class A+, A

Fields 3
220 / 240 / 120V: fluo 1x39W G5
Energy class A+, A

Fields
220 / 240 / 120V: fluo 1x80W G5
+ 1x54W G5 + 1x39W G5
Energy class A+, A

CE    IP 20 — ADA (Fields 1)

Bianco, arancio.
White, orange.

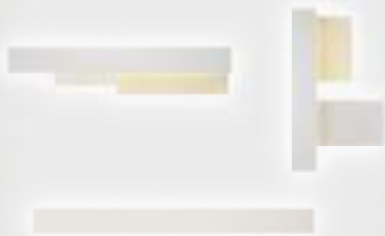

Parete, Wall



Collezioni 2017

Folio

Carlo Urbinati e Alessandro Vecchiato, 1990

grande

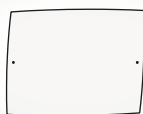

48 - 18 7/8"



38 - 15"

10
3 7/8"

piccola



33 - 13"



25 - 9 5/6"

8
3 1/8"

Vetro soffiato satinato e metallo laccato.
Blown acid-etched glass and varnished metal.

Folio grande

220 / 240V: halo o LED retrofit 1x120W R7s,
120V: halo or LED retrofit 1x150W RSC,
Energy class A+, A, C

Folio piccola

220 / 240V: halo o LED retrofit 1x120W R7s,
120V: halo or LED retrofit 1x150W RSC,
Energy class A+, A, C

CE    IP 20 

Bianco. *White.*



collection →



Parete, *Wall*



Collezioni — 2017

Gregg

Ludovica + Roberto Palomba, 2007

media



27 - 10 5/8"

piccola

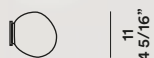
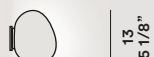

12
4 3/4"

Vetro soffiato satinato, metallo verniciato.
Blown acid-etched glass and varnished metal.

Gregg media

220 / 240V: halo 1x150W E27,
fluo o LED retrofit 1x25W E27

120V: halo 1x100W E26,
fluo or LED retrofit 1x26W E26

Energy class A+, A, B, C

Gregg piccola

220 / 240V: halo o LED retrofit 1x20W G9

120V: halo or LED retrofit 1x25W G9

Energy class A+, A, C

CE    IP 20

Bianco. *White.*



collection →

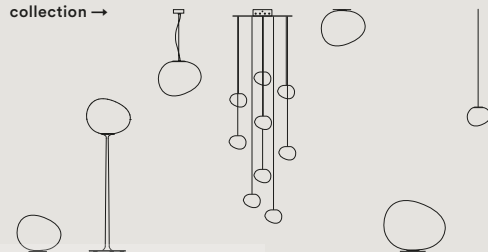

p. 050 p. 104 p. 210 p. 286 p. 308 p. 378 p. 376

Parete, *Wall*



Collezioni — 2017

Havana

Joseph Forakis, 1993

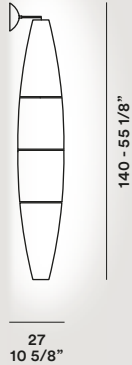

Polietilene stampato a iniezione
e metallo verniciato.
*Injection moulded polyethylene
and varnished metal.*

220 / 240V: halo 1x116W E27,
fluo o LED retrofit 1x25W E27
120V: inc 1x100W E26,
fluo or LED retrofit 1x26W E26
Energy class A+, A, B, C

CE    IP 20

Bianco. *White.*



collection →

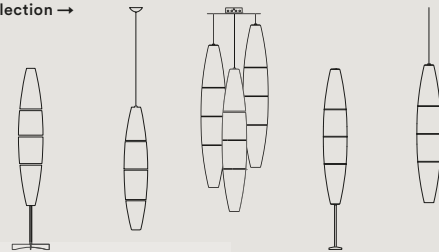

p. 106

p. 212

p. 277

p. 382

p. 380

Parete, Wall



Collezioni — 2017

Innerlight

Simon Pengelly, 2012



77 - 30 1/4"



32 - 12 1/2"

11
4 1/2"

Policarbonato traslucido e acciaio verniciato o acidato e spazzolato.
Translucent polycarbonate and varnished or acid-etched steel.

220 / 240 / 120V: fluo 2x36W 2G11
Energy class A+, A

220 / 240V dimmerabile — *dimnable*

CE    IP 20

Bianco. *White.*



LUSTROGRAD
ОПТОВЫЕ ПРОДАЖИ СВЕТИЛЬНИКОВ

Parete, *Wall*



Collezioni — 2017

Kite

Marc Sadler, 2003



16
6 1/3"

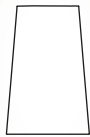

42 - 16 1/2"

27 - 10 5/8"

Tessuto di vetro con fibra di carbonio
e metallo verniciato.
*Fiber glass fabric with carbonium thread
and varnished metal.*

220 / 240V: halo 3x30W E14,
fluo o LED retrofit 3x8W E14
120V: inc 3x40W E12,
fluo or LED retrofit 3x8W E12
Energy class A+, A, B, C

CE    IP 20

Nero. Black.



collection →

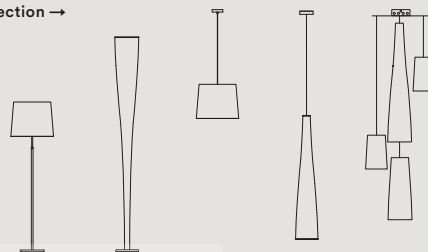

p. 102

p. 118

p. 208

p. 252

p. 282

Parete, Wall



Collezioni — 2017

Lake

Lucidi e Pevere, 2015

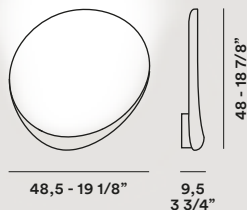

ABS stampato a iniezione.
Injection moulded ABS.

LED 12,7W 3000° K 850 lm CRI>80
Energy class A



Avorio, rosso.
Ivory, red.



Parete, Wall



Collezioni — 2017

361

Le Soleil

Vicente Garcia Jimenez, 2013

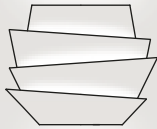

37 - 14 3/8"



29 - 11 3/8"

14 - 5 3/8"

Policarbonato stampato a iniezione
e verniciato e metallo verniciato.
*Injection moulded coated polycarbonate
and varnished metal.*

220 / 240 / 120V: fluo 2x26W G24-q3
Energy class A+, A

220 / 240V dimmerabile — *dimnable*

CE   IP 20

Bianco, rosso.
White, red.



collection →



p. 216

Parete, Wall



Collezioni — 2017

Lumiere XXL + XXS

Rodolfo Dordoni, 2010

Lumiere XXL

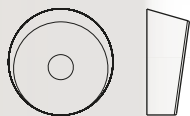

34 - 13 3/8"

13
5 1/4"

Lumiere XXS



25 - 9 5/8"

10
4 1/8"

Vetro soffiato e metallo verniciato.
Blown glass and lacquered metal.

Lumiere XXL
220 / 240V: fluo 1x40W + 1x22W 2GX13,
fluo 1x55W dimmerabile *dimmable* 2GX13
120V: fluo 1x40W 2GX13
Energy class A+, A

Lumiere XXS
220 / 240V: fluo 2x18W G24q-2
120V: fluo 2x18W G24q-2
Energy class A+, A

CE  IP 20 — **ADA** (XXS)

Bianco. *White.*



collection →



p. 066

p. 114

p. 310

Parete, Wall



Collezioni — 2017

Nuage

Philippe Nigro, 2012

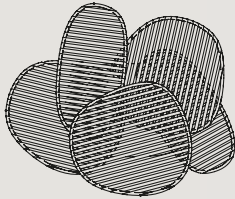

63 - 25"



34 - 13 3/8"

16 - 16 1/4"

54 - 21 1/2"

Polycarbonato stampato a iniezione,
ABS masterizzato.

*Injection-moulded polycarbonate
and batch-dyed ABS.*

Utilizzabile in composizione — *Usable
in composition*

220 / 240V: fluo 1x40W + 1x22W 2GX13
fluo 1x55W dimmerabile *dimnable* 2GX13
120V: fluo 1x40W
Energy class A+, A

CE  IP 20

Bianco, rosso.
White, red.



collection →



Parete, Wall



Collezioni — 2017

Rituals

Ludovica + Roberto Palomba, 2015

Rituals 1



Rituals 3

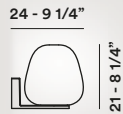

Vetro soffiato satinato inciso e metallo verniciato.
Blown engraved satin glass and lacquered metal.

Rituals 1 - 3

220 / 240V: halo 1x70W E27,
fluo o LED retrofit 1x15W E27
120V: halo 1x60W E26,
fluo or LED retrofit 1x15W E26
Energy class A+, A, B, C

Rituals 1
doppia double

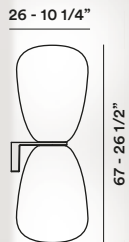

Rituals 3
doppia double



Rituals 1 - 3 doppia double

220 / 240V: halo 2x70W E27,
fluo o LED retrofit 2x15W E27
120V: halo 2x60W E26,
fluo or LED retrofit 2x15W E26
Energy class A+, A, B, C

CE    IP 20

Bianco. *White.*



collection →

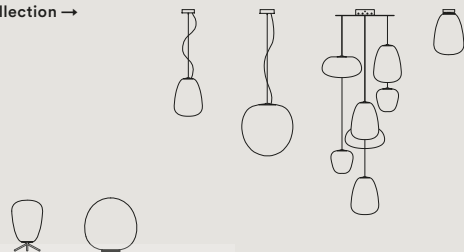

p. 074

p. 080

p. 230

p. 232

p. 283

p. 314

Parete, *Wall*

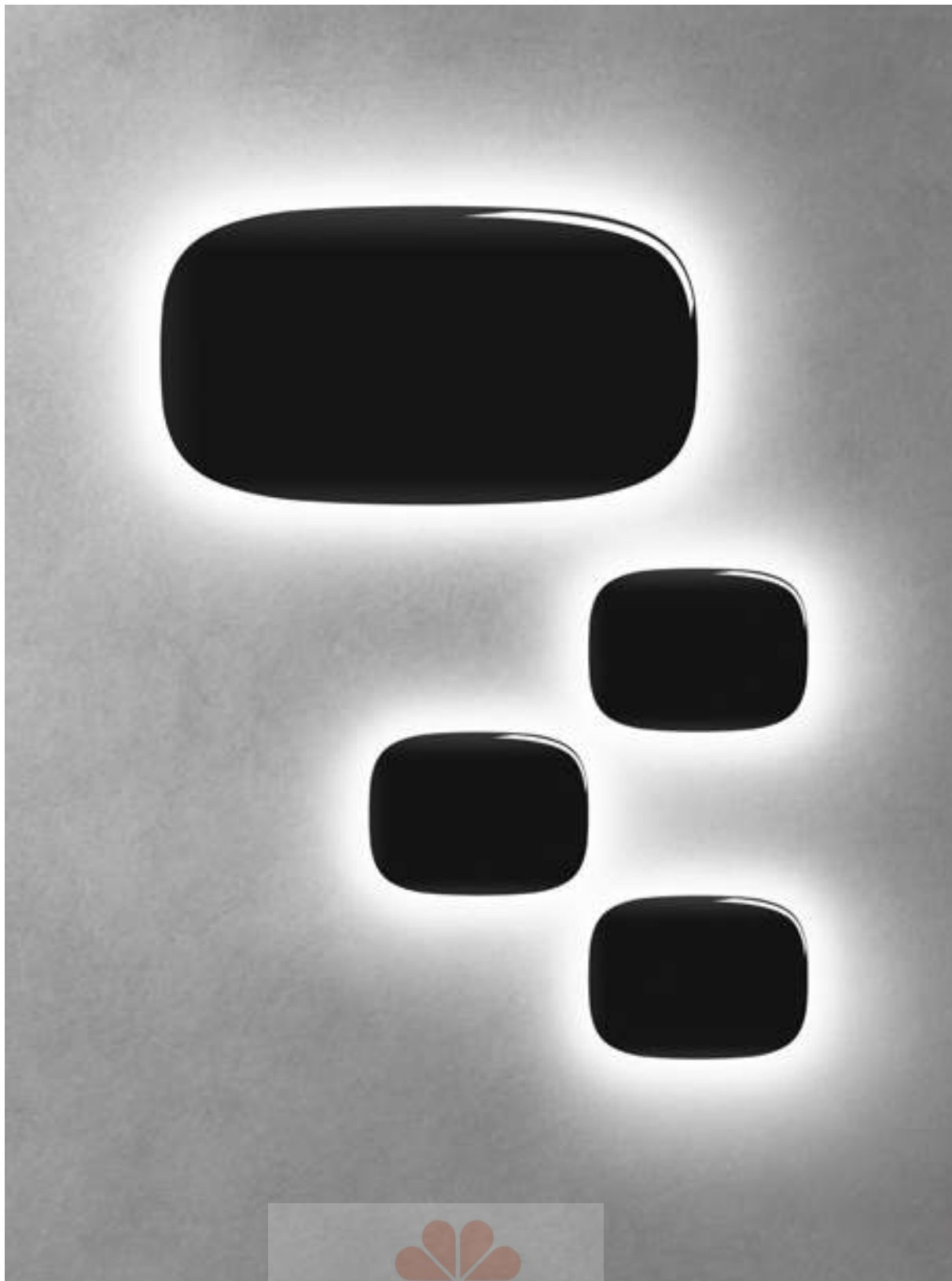

Collezioni — 2017

Tivu

Joseph Forakis, 2011

grande

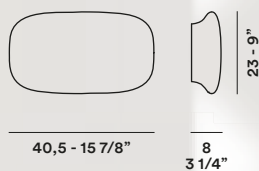

Policarbonato stampato a iniezione.
Injection moulded polycarbonate.

Tivu grande
220 / 240 / 120V: fluo 2×18W 2G11
Energy class A+, A

Anche uso in verticale — *Horizontal and vertical use*

piccola

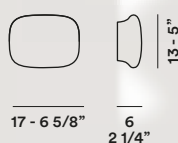

Tivu piccola
220 / 240 / 120V: halo o LED retrofit 1×20W G9
Energy class A+, A, C



Bianco, nero.
White, black.



collection →



Parete, Wall



Collezioni — 2017

Tress

Marc Sadler, 2011

grande



13,5
5 1/2"

piccola



13,5
5 1/2"

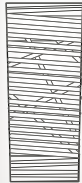

59 - 23 1/4"

25 - 10"



40 - 115 3/4"

25 - 10"

Materiale composito su base di fibra di vetro verniciato e metallo verniciato.
Varnished fibreglass based composite material and varnished metal.

220 / 240V: halo o LED retrofit 1x120W R7s
120V: halo or LED retrofit 1x100W RSC
Energy class A+, A, C

CE  IP 20

Bianco, nero.
White, black.



collection →

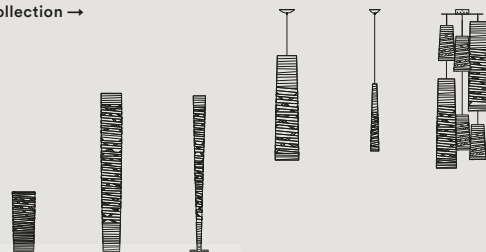

p. 082

p. 132

p. 138

p. 254-256

p. 258

p. 279

Parete, *Wall*



Collezioni — 2017

Tutù

Valerio Bottin, 2001

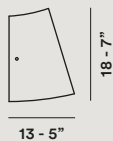
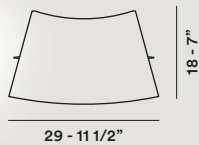

Vetro soffiato, metallo e alluminio.
Blown glass, metal and aluminium.

220 / 240V: halo 2×46W E14,
fluo o LED retrofit 2×12W E14
120V: inc 2×40W E12,
fluo or LED retrofit 2×13W E12
Energy class A+, A, B, C

CE  IP 20

Bianco, avorio.
White, ivory.





Esterno — *Outdoor*

376 **Gregg**
outdoor sospensione

378 **Gregg**
outdoor terra

380 **Havana**
outdoor sospensione

382 **Havana**
outdoor terra

386 **Solar outdoor**

388 **Uto**



Esterno, *Outdoor*



Collezioni — 2017

Gregg outdoor sospensione

Ludovica + Roberto Palomba, 2011

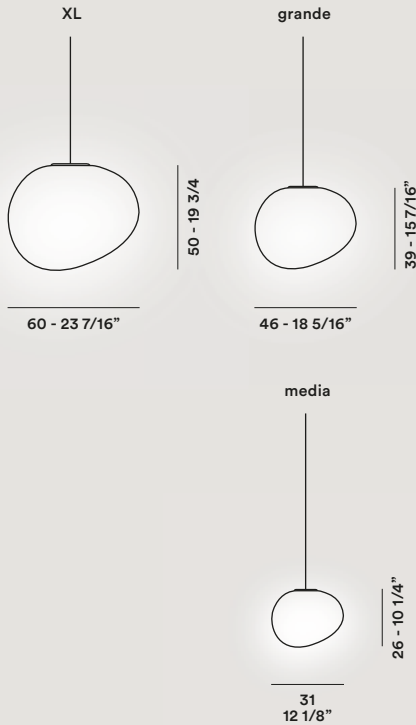

Polietilene stampato in rotazionale e metallo verniciato.
Rotational moulded polyethylene and varnished metal.

Gregg outdoor XL - grande
220 / 240V: fluo o LED retrofit 1x25W E27
120V: fluo or LED retrofit 1x26W E26
Energy class A+, A

Gregg outdoor media
220 / 240V: fluo o LED retrofit 1x15W E27
120V: fluo or LED retrofit 1x13W E26
Energy class A+, A

CE  IP 44 IP 65

Suitable for wet location

Bianco. *White.*

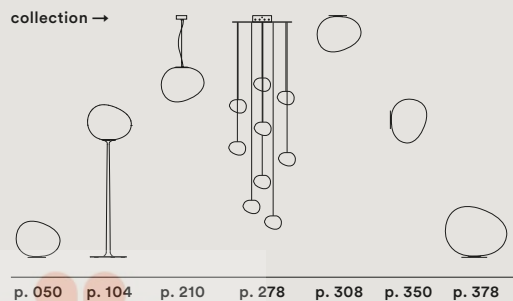

Esterno, *Outdoor*

Collezioni — 2017



Gregg outdoor terra

Ludovica + Roberto Palomba, 2011

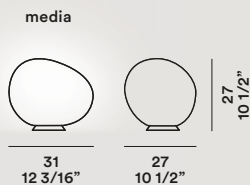
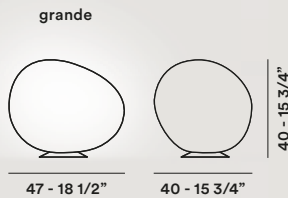
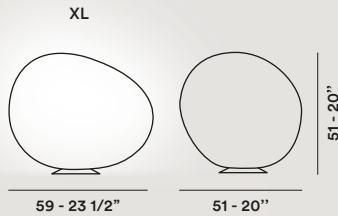

Polietilene stampato in rotazionale e metallo verniciato.
Rotational moulded polyethylene and varnished metal.

Gregg outdoor XL - grande
220 / 240V: fluo o LED retrofit 1x25W E27
120V: fluo or LED retrofit 1x26W E26
Energy class A+, A

Gregg outdoor media
220 / 240V: fluo o LED retrofit 1x15W E27
120V: fluo or LED retrofit 1x13W E26
Energy class A+, A

CE  IP 44 IP 65

Suitable for wet location

Bianco. *White.*

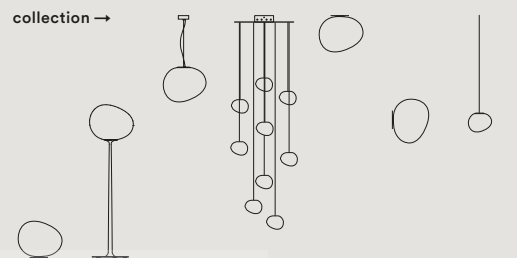

p. 050 p. 104 p. 210 p. 278 p. 308 p. 350 p. 376

Esterno, *Outdoor*



Collezioni — 2017

Havana outdoor sospensione

Joseph Forakis, 2005

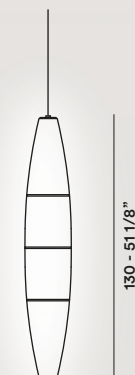

23 - 9 1/16"

Polietilene stampato in rotazionale e metallo verniciato.

Rotational moulded polyethylene and varnished metal.

220 / 240V: halo 1x46W E27,

fluo o LED retrofit 1x15W E27

120V: inc 1x60W E26,

fluo or LED retrofit 1x13W E26

Energy class A+, A, B, C

CE  IP 44 IP 65

Suitable for wet location

Bianco. *White.*



collection →

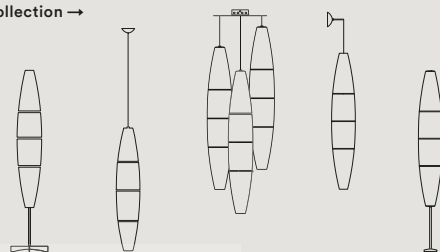

p. 106

p. 212

p. 277

p. 352

p. 382

Esterno, *Outdoor*



Collezioni — 2017



Esterno, *Outdoor*

Collezioni — 2017

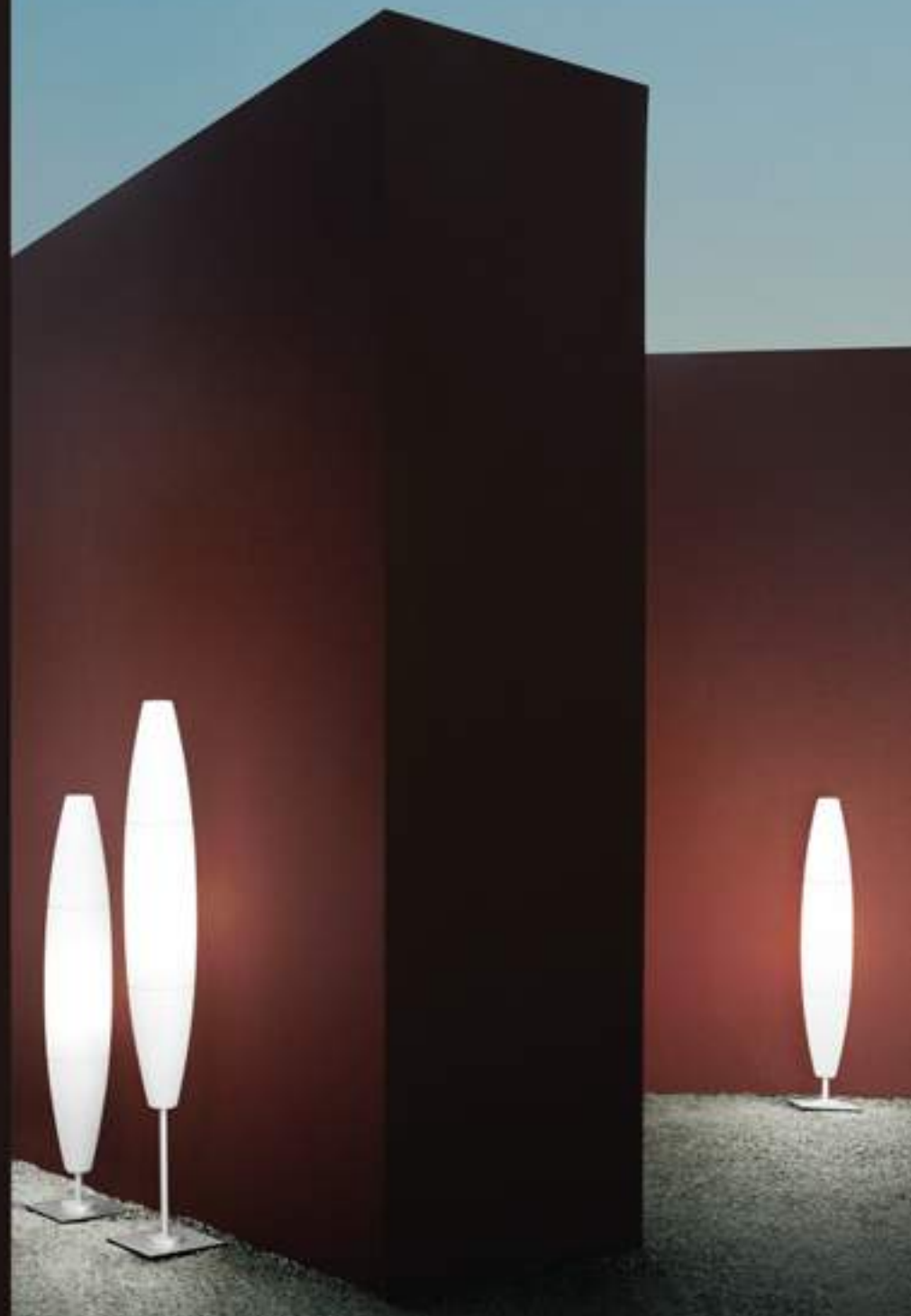

Havana outdoor terra

Joseph Forakis, 2005

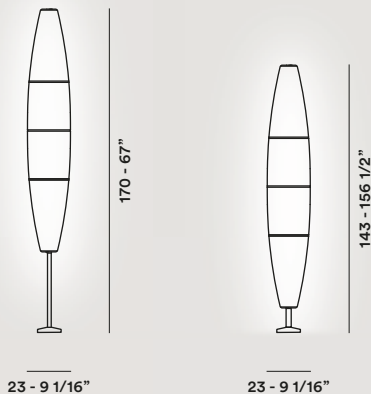

Polietilene stampato in rotazionale e metallo verniciato.
Rotational moulded polyethylene and varnished metal.

220 / 240V: halo 1x46W E27,
fluo o LED retrofit 1x15W E27
120V: inc 1x60W E26,
fluo or LED retrofit 1x13W E26
Energy class A+, A, B, C

CE  IP 44 IP 65

Suitable for wet location

Bianco. White.

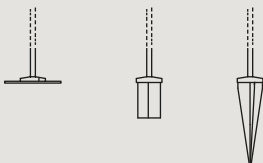

collection →

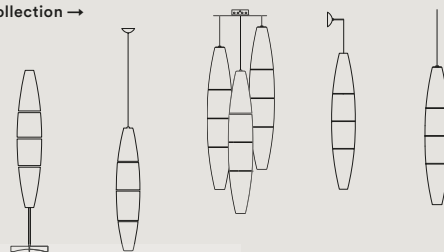

p. 106

p. 212

p. 277

p. 352

p. 380

Esterno, *Outdoor*



Collezioni — 2017

Solar outdoor

Jean Marie Massaud, 2011

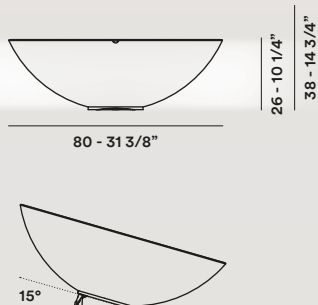

Polietilene stampato a rotazione,
gres e metallo verniciato.
*Rotational moulded polyethylene,
gres and varnished metal.*

220 / 240V: fluo o LED retrofit 1x25W E27
120V: fluo or LED retrofit 1x26W E26
Energy class A+, A

CE □   IP 44 IP 65

Suitable for wet location

Marrone. *Brown.*



Esterno, *Outdoor*

Collezioni — 2017



Uto

Lagranja Design, 2005



20 - 7 7/8"

Elastomero termoplastico
e policarbonato.
*Thermoplastic elastomer
and polycarbonate.*

220 / 240V: fluo o LED retrofit 1x15W E27
120V: fluo or LED retrofit 1x13W E26
Energy class A+, A

CE  IP 44

Suitable for damp location

Bianco, giallo, arancio.
White, yellow, orange.



collection →

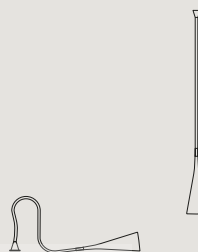

p. 086

p. 270

Stories

Collezioni — 2017



*Textes en français — Deutsche Texte
— Textos en español*

392 **Allegro**

392 **Aplomb**

393 **Bahia**

394 **Big Bang**

395 **Buds**

395 **Caboche**

396 **Havana**

397 **Kurage**

398 **Lumiere**

398 **Mite**

399 **Orbital**

400 **Rituals**

400 **Spokes**

401 **Tartan**

402 **Tress**

403 **Tuareg**

404 **Twiggy**

405 **Company**

Stories

Allegro —
Atelier Oi, 2007
p. 160

FR → *Allegro, une symphonie d'ombres et de lumières. Si elle peut évoquer, au premier regard, un instrument de musique ou un surprenant décor planant dans les airs, elle représente en réalité une façon très spéciale d'éclairer et de personnaliser l'espace. Allegro n'est pas une lampe, mais un projet qui associe des lignes fines réalisées avec des tiges en aluminium pour créer des formes tridimensionnelles, suspendues et immatérielles, à travers lesquelles la lumière se diffuse dans l'espace, l'habillant de subtils jeux d'ombres. Comme les notes de musique, Allegro se prête à une infinité d'ambiances, intimes, romantiques ou majestueuses : Allegro et Allegretto Ritmico, Vivace, Assai pouvant être installées seules ou en série, à la maison ou dans les espaces dédiés au grand public.*

DE → *Allegro – eine Symphonie aus Licht und Schatten. Auf den ersten Blick erinnert Allegro an ein musikalisches Instrument oder eine ungewöhnliche, frei in der Luft schwebende Installation, sie ist in der Tat eine völlig neue Form der Beleuchtung und Raumgestaltung. Denn Allegro ist nicht einfach nur eine Leuchte, sondern*

vielmehr ein bezauberndes Zusammenspiel zarter Linien. Ihre dünnen Aluminiumrohre bilden dreidimensionale Formen, die wie körperlos im Raum schweben und durch die das Licht nach außen dringt und magische Schattenspiele an die Wand zeichnet. Wie aus Noten lassen sich auch aus den Allegro-Modellen eine unendliche Vielzahl verspielter, romantischer oder majestätischer Kompositionen bilden. Allegro und Allegretto Ritmico, Vivace, Assai wie auch die anderen eignen sich sowohl allein als auch in Kompositionen aus mehreren Leuchten hervorragend für den Einsatz in den eigenen vier Wänden und im öffentlichen Raum.

ESP → *Allegro, sinfonía de luz y sombras. A primera vista puede parecer un instrumento musical o una sorprendente escenografía que se lleva a cabo en el aire, pero en realidad es una forma muy especial de iluminar y caracterizar el espacio. Allegro no es una lámpara sino un proyecto que combina líneas finas, realizadas con tubos de aluminio, con formas tridimensionales, suspendidas e inmateriales, a través de las cuales la luz se difunde en el ambiente, vistiéndolo de mágicos juegos de sombras. Como las notas musicales, Allegro se presta a infinitas ambientaciones íntimas, románticas o majestuosas: Allegro y Allegretto Ritmico, Vivace, Assai se pueden*

ambientar solas o en grupo, en casa o en los espacios dedicados al gran público.

Aplomb —
Lucidi e Pevere, 2010/2015
p. 168

FR → *Née de la volonté d'utiliser le ciment brut, matériau typique des grandes structures architectoniques modernes, pour créer un objet illuminant aux formes fines et raffinées, la lampe Aplomb a obtenu un grand succès dès son exorde. Aplomb est réalisée grâce à un procès artisanal et créée par des experts italiens dans la fabrication du ciment. Le défi de conception a été celui d'obtenir des épaisseurs plus fines, des formes légères et une surface donnant du corps à la matière tout en restant agréable au toucher. Un résultat obtenu grâce aux soins et à la profonde connaissance du matériau, ce qui a permis de créer un amalgame spécial, particulièrement fluide dans le moule pendant sa réalisation. C'est toujours à partir de ce matériau que naît une version encore plus petite – Aplomb mini – utilisable seule ou en association avec le modèle originale et Aplomb Large, une nouvelle lampe en ciment, avec une forme et des caractéristiques d'utilisation différentes par rapport à la version originale. Aplomb Large possède une source de lumière LED intégrée encastrée dans le corps de la lampe, qui*

propose un faisceau lumineux large vers le plan situé au-dessous, contrairement à la version originale d'Aplomb qui se caractérise par son éclairage ciblé.

DE → Aplomb entstand aus dem Wunsch, mit rohem Zement zu arbeiten – einem Material, das vor allem in der modernen Architektur in großem Stil zum Einsatz kommt – und daraus eine grazile, raffinierte Leuchte zu schaffen. Gefertigt wird Aplomb nach handwerklichem Verfahren von italienischen Experten im Bereich der Zementverarbeitung. Im Rahmen der Entwicklung der Leuchte bestand die Herausforderung vor allem darin, eine geringe Materialstärke, leichte Formen und eine raue, aber zugleich haptisch angenehme Oberfläche zu erzielen. Ein Ergebnis, das nur aufgrund sorgfältiger Studien und umfassender Kenntnis des Werkstoffs erreicht werden konnte. Diese ermöglichten die Entwicklung einer speziellen Mischung, die beim Guss besonders flüssig bleibt. Ebenfalls aus Zement besteht auch die im Verhältnis zur ersten Aplomb-Hängeleuchte etwas kleinere Ausführung des Modells – Aplomb mini - das allein oder in Kombination mit der größeren Variante eingesetzt werden kann. Aplomb Large ist ein neues Leuchten Modell aus Zement mit anderer Form und Funktion als die

Originalversion. Abgesehen von ihren großzügigeren Maßen unterscheidet sich Aplomb Large auch hinsichtlich der Lichtquelle. Die in die Leuchte eingebaute, integrierte LEDLampe leuchtet breit nach unten, während sich das Original durch einen punktuellen Lichtstrahl auszeichnet.

ESP → Nacida de la voluntad de utilizar el cemento bruto, materia típica de las grandes estructuras arquitectónicas modernas, para crear un objeto iluminante de formas finas y refinadas, la lámpara Aplomb ha obtenido desde sus inicios un gran éxito. Aplomb se fabrica mediante un proceso artesanal por cuenta de expertos italianos en la elaboración del cemento. El reto proyectivo es obtener espesores finos, formas ligeras y una superficie matérica pero al mismo tiempo agradable al tacto. Un resultado conseguido gracias al cuidado y al profundo conocimiento del material, que ha llevado a descubrir una mezcla especial, muy fluida en el molde durante la realización. De este material nace también una versión todavía más pequeña – Aplomb mini – utilizable sola o combinada con el modelo original y Aplomb Large, una nueva lámpara de cemento, con forma y características de uso distintas respecto a la versión original. Aplomb Large cuenta con una fuente luminosa de LED integrada, empotrada en

el cuerpo de la lámpara, que ofrece un amplio haz de luz hacia la parte inferior, a diferencia de la versión original de Aplomb que se caracteriza en cambio por una iluminación puntual.

Bahia —
Lucidi e Pevere, 2010
p. 324

FR → Bahia, une élégance fascinante. Éclairer, mais aussi décorer un espace, avec une présence douce, poétique et infiniment séduisante, telle est la fascinante promesse de Bahia. Une harmonie d'ombres et de lumières, générée par la simple superposition de trois diffuseurs, disposés selon une asymétrie et une alternance entre surfaces concaves et convexes bien calculées, dans une forme évoquant l'image d'une île vue de haut. Entièrement blanche, pure et absolue, capable de couvrir une grande surface mais avec une épaisseur minimale, Bahia revêt une sensationnelle profondeur visuelle grâce aux lueurs concentriques qu'elle émane, la lumière étant réfléchie sur le mur et diffusée dans l'espace environnant. Seule ou en composition multiple, avec la possibilité de l'orienter de différentes manières pour créer des jeux graphiques, Bahia diffuse dans chaque espace une émotion originale et une lumière séduisante.

DE → Bahia – Eleganz, die verzaubert. Sanft, poetisch

Stories

und faszinierend. Mit ihrem verführerischen Licht setzt Bahia interessante Akzente und sorgt für angenehme Beleuchtung.

Die drei aufeinanderliegenden Diffusoren lassen ein harmonisches Spiel von Licht und Schatten entstehen.

Die asymmetrisch angeordneten, konvexen und konkaven Scheiben wecken Assoziationen an das Bild einer Insel aus Vogelperspektive. Ganz in Weiß, absolut rein und leuchtend präsentiert sich Bahia großflächig aber sie baut wenig auf. Ihre konzentrischen Lichtkreise verleihen der Leuchte eine sensationelle optische Tiefe, werden von der Wand reflektiert und sorgen so für ein angenehmes Raumlicht. Bahia macht sich gut allein, erzielt aber auch in Mehrfach-Kompositionen, etwa durch unterschiedliche Ausrichtung der einzelnen Leuchten, eine schöne Wirkung und wertet so jede Umgebung durch ihre originelle Gestalt und ihr faszinierendes Licht auf.

ESP → Bahia, fascinante elegancia. Iluminar y al mismo tiempo amueblar un ambiente, con una presencia suave, poética e infinitamente fascinante: ésta es la seductora promesa de Bahia. Una armonía de luces y sombras, generada por la simple superposición de tres difusores, colocados siguiendo una estudiada asimetría y alternancia de superficies cóncavas y convexas, en una forma que recuerda

una isla vista desde arriba. Completamente blanca, pura y absoluta, capaz de cubrir un área amplia pero con un grosor mínimo, Bahia asume una sensacional profundidad visual, gracias a los resplandores concéntricos que emana, reflejándose en la pared y extendiéndose en el espacio circundante. Solo o en composiciones múltiples, incluso con orientaciones diversas para crear juegos gráficos, Bahia propaga en cualquier espacio una emoción original y una iluminación fascinante.

Big Bang —

Enrico Franzolini con Vicente Garcia Jimenez, 2005
p. 180

FR → Big Bang, une force explosive. Seule Foscarini pouvait transformer une idée aussi extrême et aussi inédite, inspirée de l'art contemporain et de l'architecture d'avant-garde, en une lampe d'un tel succès. Réalisée en méthacrylate et aluminium verni, Big Bang est une explosion de plans qui s'entrecoupent, créant de multiples jeux d'ombres et de lumière, avec un éclairage à la fois direct et réfléchi. Un effet ultérieurement souligné dans la version bicolore, ou au contraire estompé dans la version monochrome, pour une lampe qui, dans tous les cas, est loin de passer inaperçue. Dans la version à LED, la

présence spectaculaire unique et la formidable réalisation technique s'allient à une efficacité énergétique accrue.

DE → Big Bang – die Kraft einer Explosion. Bereits die Ausgangsidee zu Big Bang war mehr als ungewöhnlich, in dieser Form völlig neu, inspiriert von den Entwicklungen in der zeitgenössischen Kunst und modernen Architektur. Doch Foscarini wäre nicht Foscarini, würde das Unternehmen daraus nicht eine Leuchte von durchschlagendem Erfolg zaubern. Aus Methacrylat und lackiertem Aluminium gefertigt wirkt Big Bang mit ihren verschiedenen, einander überschneidenden Ebenen wie die grafische Darstellung einer Explosion. Das Ergebnis sind reizvolle Licht- und Schattenspiele und eine zugleich direkte wie auch indirekte Lichtabgabe. Ein eleganter Kontrast, der in der zweifarbigen Ausführung noch stärker zur Geltung kommt, in der einfarbigen Version hingegen etwas abgemildert wird und die Leuchte in beiden Fällen zum unwiderstehlichen Hingucker macht. In der Ausführung mit LED-Beleuchtung überzeugt Big Bang neben ihrer faszinierenden Optik und unverwechselbaren Lichtwirkung zusätzlich auch mit deutlich verbesserter Energieeffizienz.

ESP → Big Bang, fuerza explosiva. Sólo Foscarini podía

transformar una idea tan extrema, inédita, inspirada en el arte contemporáneo y en la arquitectura de vanguardia, en una lámpara de gran éxito. Realizada en metacrilato y aluminio pintado, Big Bang es una explosión de plataformas que se entrecruzan, creando múltiples juegos de luz y sombras, con una iluminación directa y reflejada al mismo tiempo. Un efecto que destaca todavía más en la versión bicolor, o que aparece más degradada en la monocromática, para una lámpara que, en cualquier caso, no nace para pasar desapercibida. Además, en la versión de LED, a la inconfundible presencia escénica e iluminotécnica se añade una eficiencia energética todavía mayor.

Buds —

Rodolfo Dordoni, 2007/2016
p. 036

FR → Dans les années 90, Rodolfo Dordoni dessine pour Foscarini une collection de luminaires (lampes de table, sur pied et suspensions) dotés de diffuseurs en verre soufflé et aux couleurs vives, dont les noms évoquent des éléments de la nature : Fruits, Blossom et Buds. Aujourd'hui, Buds fait une peau neuve et interprète le style contemporain à travers une richesse raffinée et une attention particulière pour les matériaux. Le verre soufflé reste au cœur du projet, avec un usinage artisanal

à cinq couches, appréciable à première vue grâce à la coupe plus ample du diffuseur. Avec sa gamme de couleurs – marron froid, gris froid, vert bambou et blanc chaud, avec une finition ivoire à l'intérieur – Buds assume sa double personnalité : chaude lors que la lampe est allumée, et froide lorsqu'elle est éteinte.

DE → In den 90er Jahren entwarf Rodolfo Dordoni für Foscarini eine Kollektion an Tisch-, Boden- und Hängeleuchten mit Diffusoren aus geblasenem Glas in besonders leuchtenden Farben, deren Namen an die Welt der Natur erinnern – Fruits, Blossom und Buds. Letztere, Buds, wurde nun erneut überarbeitet und unter Berücksichtigung aktueller Trends neu interpretiert, mit einem besonderen Augenmerk für raffinierte Details sowie die Auswahl der verwendeten Materialien. Im Mittelpunkt des Projekts stand dabei, wie immer, die Arbeit mit mundgeblasenem Glas. Der von Hand gearbeitete Diffusor besteht aus fünf Schichten, die dank direktem Blick auf den Querschnitt des Materials besonders schön zur Geltung kommen. Die Farbpalette – kaltes Braun, kaltes Grau, Bambusgrün und warmes Weiß mit strohgelber Innenseite – verleiht Buds zwei Gesichter: In eingeschaltetem Zustand wirkt die Leuchte anheimelnd warm, ausgeschaltet besticht sie durch kühle Eleganz.

ESP → Durante la década de los 90 Rodolfo Dordoni diseñó para Foscarini una colección de lámparas de mesa, tierra y suspensión con difusores en vidrio soplado de colores llamativos y nombres que evocaban elementos naturales: Fruits, Blossom y Buds. Ahora Buds se renueva, interpretando el gusto contemporáneo para conseguir una refinada riqueza y atención en los materiales. El protagonista del proyecto es, como siempre, el vidrio soplado, con una elaboración artesanal de cinco capas, que se nota enseguida gracias al corte más amplio del difusor. Con la gama de colores – marrón frío, gris frío, verde bambú y blanco cálido, con acabado pajizo en el interior – Buds asume un doble valor: cálida cuando la lámpara está encendida y fría cuando está apagada.

Caboche —

Patricia Urquiola con Eliana Gerotto, 2005
p. 192

FR → Caboche, un bijou de design. Les femmes ont la faculté de capter les aspects les plus inattendus des choses. Quand en plus il s'agit de deux designers, leur créativité ne peut que donner naissance à une lampe aussi surprenante que séduisante : Caboche. Sa forme s'inspire d'un bracelet de perles, mais se transforme en une composition de sphères transparentes et scintillantes comme des

Stories

diamants, mais réalisées à partir d'un matériau léger, résistant et technologiquement contemporain : le polyméthilméthacrylate, en version cristal ou jaune or. Les sphères peuvent donner vie à des lampes de taille différente, du petit modèle de suspension à la grande installation, pour créer d'irrésistibles bijoux lumineux, capables d'apporter un charme précieux aux espaces les plus divers.

DE → Caboche – das Designjuwel. Frauen haben das Talent, an Dingen oft gänzlich unerwartete Seiten zu entdecken. Handelt es sich dabei noch dazu um zwei Designerinnen, kann aus ihrer gemeinsamen kreativen Arbeit gar nichts anderes entstehen als eine ebenso erstaunliche wie faszinierende Leuchte – Caboche. Ihre Form ist einem Perlenarmband nachempfunden und besteht aus einer Reihe kunstvoll arrangierter transparenter Kugeln, die wie Diamanten im Licht glitzern. Gefertigt sind diese jedoch aus leichtem, widerstandsfähigem und technologisch fortschrittlicherem Polymethylmethacrylat in den Farbausführungen klar oder goldgelb. Die Leuchte ist in verschiedenen Größen erhältlich, vom kleinen Hängeleuchtenmodell bis hin zu größeren Kompositionen, deren unwiderstehliche, leuchtende Kristalle in den unterschiedlichsten Umgebungen als eleganter Blickfang wirken.

ESP → Caboche, joya de diseño. Las mujeres saben apreciar siempre los aspectos más inesperados de las cosas. Si además se trata de dos diseñadoras, de su creatividad no pueda nacer nada más que una lámpara tan sorprendente como fascinante: Caboche. Su forma se inspira en una pulsera de perlas, pero se transforma en una composición de esferas transparentes, centelleantes como diamantes pero realizadas con un material ligero, duradero y tecnológicamente contemporáneo: el polimetilmetacrilato, en versión cristal o amarillo oro. Las esferas pueden dar vida a lámparas de diversos tamaños, del pequeño modelo de suspensión a la gran instalación, creando irresistibles joyas luminosas que añaden un encanto precioso a una gran variedad de entornos.

Havana —
Jozeph Forakis, 1993
p. 106

FR → Havana, une lampe révolutionnaire. Vous pouvez la rencontrer un peu partout : dans un salon élégant, dans un établissement à la mode ou au bord d'une piscine. Fuselée comme un cigare, Havana possède un style sans âge qui lui permet de trouver sa place dans tous les espaces et de diffuser autour d'elle une lumière chaude, diffuse et solaire. Réalisée en polyéthylène blanc,

un matériau léger, solide, résistant et recyclable, elle est disponible en version sur pied et à suspension, pour intérieur ou extérieur, et peut être installée seule ou en différents types de compositions. Accueillie au sein de la collection permanente du Museum of Modern Art de New York, il s'agit de l'un des plus gros succès de Foscarini, un exemple venant démontrer comment le design le plus raffiné peut se permettre une certaine forme d'accessibilité, de légèreté et d'ironie.

DE → Havana – die Revolutionäre. An den unterschiedlichsten Orten stößt man auf sie – in einem eleganten Wohnzimmer ebenso wie in einem Szenelokal oder am Rand eines Schwimmbekens. Ihre langgezogene Zigarrenform verleiht Havana eine zeitlose Optik, die sich perfekt in jedes Ambiente einfügt und ihre Umgebung mit einem warmen, diffusen, sonnigen Licht verwöhnt. Der Diffusor besteht aus weißem Polyethylen, einem leichten, langlebigen, widerstandsfähigen und recycelbarem Material. Havana ist als Boden- wie auch als Hängeleuchte erhältlich, eignet sich sowohl für den Innen- wie auch den Außenbereich und überzeugt alleinstehend ebenso wie in Mehrfach-Kompositionen. Inzwischen hat Havana darüber hinaus auch einen festen Platz in der ständigen Ausstellung des Museum of Modern Art in New York und zählt damit

unbestritten zu den absoluten Erfolgsleuchten von Foscarini. Ein schönes Beispiel dafür, dass auch raffiniertes Design auf sympathische Weise breitenwirksam funktionieren kann – mit Leichtigkeit und Ironie.

ESP → Havana, lámpara revolucionaria. Es posible encontrarla en cualquier sitio: en un elegante salón, un local de tendencia o en el borde de una piscina. Delgada como un puro, Havana tiene un estilo sin edad y se encuentra perfectamente a su gusto en cualquier ambiente, difundiendo a su alrededor una luminosidad cálida, suave y solar. Se realiza en polietileno blanco: un material ligero, duradero, resistente y reciclable. Se encuentra disponible en versión de tierra y de suspensión, para internos o externos y se ambienta sola o en fascinantes composiciones múltiples. Forma parte de la colección permanente del Museum of Modern Art de Nueva York y es uno de los mayores éxitos de Foscarini: un ejemplo que demuestra que incluso el diseño más refinado puede permitirse un agradable sabor de accesibilidad, ligereza e ironía.

Kurage —
Nichetto + Nendo, 2015
p. 052

FR → C'est de la collaboration entre le

designer italien Luca Nichetto et le groupe de travail multidisciplinaire Nendo, fondé par l'architecte japonais Oki Sato, que naît un projet à l'esprit léger, poétique et artisanal : la lampe de table Kurage. En japonais, Kurage signifie méduse et, en effet, cette lampe ressemble à un animal marin qui danse léger, bercé par une luminosité tamisée, due à l'utilisation du précieux papier Washi japonais. Le diffuseur est simplement posé sur une structure transparente conçue spécialement pour garantir l'absence d'ombres. Kurage est réalisée à l'aide d'un procédé très particulier développé par Aoya, seul producteur de papier Washi en trois dimensions, fait main dans la ville de Tottori au Japon. En utilisant des fibres de l'arbre de mûrier, on obtient un papier lisse et poreux à la fois qui filtre la lumière en créant une atmosphère détendue, chaude et émouvante, capable de séduire l'intelligence et le cœur. Pour compléter le projet, quatre pieds fins en bois de frêne couleur naturelle, le porte-lampe en céramique blanche et le câble électrique recouvert d'un bas en fibre de papier.

DE → Aus der Zusammenarbeit zwischen dem italienischen Designer Luca Nichetto und der multidisziplinären Arbeitsgruppe Nendo des japanischen Architekten Oki Sato entstand eine leichtfüßige,

poetische Tischleuchte mit handwerklichem Anspruch: Kurage. "Kurage" bedeutet im Japanischen "Qualle". Und tatsächlich ähnelt die Leuchte den zarten Meeresbewohnern, die zu tanzen scheinen umgeben von einem sanften Licht, das durch die Verwendung von wertvollem japanischem Washi-Papier erzeugt wird. Der Diffusor wird von einem speziell entwickelten, transparenten Gestell gestützt, das keinerlei Schatten wirft. Die Leuchte entstand mithilfe eines innovativen Verarbeitungsverfahrens. Dieses wurde von Aoya, dem einzigen Hersteller von dreidimensional geformtem Washi-Papier, das in der japanischen Stadt Tottori von Hand geschöpft wird, entwickelt. Das aus Maulbeerbaumfasern erzeugte Washi-Papier ist glatt und porös zugleich, es filtert das Licht und schafft eine entspannte, warme und gefühlvolle Atmosphäre, die sowohl Geist als auch Herz verzaubert. Die vier dünnen Beine bestehen aus naturbelassenem Eschenholz, die Lampenfassung aus weißer Keramik. Das Kabel ist mit Papierfasern ummantelt.

ESP → De la colaboración entre el diseñador italiano Luca Nichetto y el grupo de trabajo multidisciplinario Nendo, fundado por el arquitecto japonés Oki Sato, nace un proyecto de estilo ligero, poético y artesanal: la lámpara

Stories

de mesa Kurage. Kurage en japonés significa medusa y de hecho esta lámpara se parece a un animal marino que baila ligero, mecido por una luminosidad suave que se obtiene gracias a la utilización de un papel washi japonés de alta calidad. El difusor se apoya simplemente sobre una estructura transparente estudiada ad hoc para garantizar la ausencia de sombras. Kurage se fabrica gracias a una particular técnica de elaboración desarrollada por Aoya, el único fabricante de papel washi tridimensional, hecho a mano en la ciudad de Tottori, en Japón. Utilizando fibras del árbol de morera, se obtiene un papel liso y poroso al mismo tiempo que filtra la luz creando una atmósfera relajada, cálida y emocionante, capaz de seducir el intelecto y el corazón. Completan el proyecto cuatro finas patas en madera de fresno de color natural, el portalámpara en cerámica blanca y el cable eléctrico cubierto con una funda en fibra de papel.

Lumiere —
Rodolfo Dordoni, 1990
p. 058

FR → Lumiere, l'inévitable best-seller. Depuis sa naissance au XVIIème siècle à Paris, l'abat-jour est passé par d'innombrables interprétations. Puis en 1990, la rencontre entre un designer et une entreprise italienne donne vie à une

idée neuve dans le monde de l'éclairage : Lumiere. Une relecture érudite et raffinée de l'abat-jour classique, avec un précieux diffuseur en verre soufflé – disponible en des couleurs différentes, avec une couche à l'intérieur qui produit une lumière encore plus douce et chaude – associé à un trépied unique en aluminium moulé sous pression. Lumiere a toujours une histoire merveilleuse et différente à raconter. Pour célébrer son 25ème anniversaire, Lumiere se présente dans une édition spéciale, avec une finition métallisée du verre qui laisse entrevoir comme par magie l'ampoule placée à l'intérieur.

DE → Lumiere – der unverwechselbare Bestseller. Im 17. Jahrhundert entstanden in Paris die ersten Tischleuchten – seither wurde diese Form immer wieder neu interpretiert. Im Jahr 1990 wurde schließlich bei einem Treffen zwischen einem Designer und einem italienischen Unternehmen eine in der Welt der Beleuchtung bisher nie da gewesene Idee geboren. Lumiere. Eine raffinierte und elegante Neuinterpretation der klassischen Tischleuchte mit einem kostbaren Diffusor aus geblasenem Glas, erhältlich in verschiedenen Farbvarianten, mit einer inneren Schicht, die ein noch weiches und wärmeres Licht verströmt. Als Stütze für den Schirm dient ein charakteristischer Dreifuß aus druckgegossenem Aluminium.

Zu seinem 25-jährigen Jubiläum ist Lumiere ab nun zudem in einer Sonderausgabe mit metallisierter Oberfläche erhältlich, die auf magische Weise die Lichtquelle im Inneren der Leuchte durch das Glas schimmern lässt.

ESP → Lumiere, imperdible best-seller. Las pantallas para lámparas nacieron en el siglo XVII en París y, desde entonces hasta nuestros días, han atravesado innumerables interpretaciones. En el año 1990, del encuentro entre un diseñador y una empresa italiana, nació una idea nueva en el mundo de la iluminación: Lumiere. Una relectura culta y refinada de la clásica pantalla, con un precioso difusor en vidrio soplado – con diferentes tonalidades y una capa al interior que hace que la luz sea más suave y cálida – junto con un inconfundible trípode en aluminio fundido bajo presión. Lumiere dispone siempre de una historia espléndida y distinta para contar. En el 25 aniversario de su creación, Lumiere se presenta en una edición especial, con un tratamiento metalizado del vidrio que deja entrever mágicamente la fuente luminosa situada en el interior.

Mite —
Marc Sadler, 2000
p. 118

FR → Mite, une personnalité unique. Élancée, élégante, importante et unique, allumée

comme éteinte. Une forme sinieuse, revêtue d'une trame de verre, un matériau à la tradition millénaire, et fil de carbone ou Kevlar®, les mêmes fibres technologiques que celles utilisées pour créer des bateaux à voile et des clubs de golf. Une innovation absolue qui a valu à Mite, et à la version suspendue de Tite, le prix du Compasso d'Oro en 2001, une des reconnaissances les plus prestigieuses du monde. Une lampe qui est devenue une icône dans le paysage de l'éclairage et qui exprime, dans sa version à LED, une luminosité encore plus fascinante, avec en plus l'avantage d'une technologie respectueuse de l'environnement.

DE → Mite – einfach legendär. Schlank, elegant, stattlich und ob an oder aus einfach unverwechselbar. Die geschwungene Form von Mite besteht aus einem Mischgewebe aus Glas, Material mit jahrtausendealter Tradition, und Carbonfasern oder Kevlar®-Band, denselben Technofasern, aus denen auch Segelboote und Golfschläger gefertigt werden. Eine absolute Innovation, die im Jahr 2001 Mite – zusammen mit der Ausführung als Hängeleuchte Tite – einen der renommiertesten Designpreise der Welt, den begehrten Compasso d'Oro eingebracht hat. Mittlerweile gilt die Leuchte im Beleuchtungssektor als Designikone. Die LED-Ausführung besticht

durch noch schönere Lichtabgabe und den Vorteil eines umweltfreundlichen Innenlebens.

ESP → Mite, personalidad mítica. Esbelta, elegante, importante, inconfundible tanto encendida como apagada. Una forma sinuosa, vestida con una malla de vidrio, un material de tradición milenaria, e hilo de carbono o de Kevlar®, las mismas fibras tecnológicas utilizadas para crear barcos de vela y palos de golf. Una innovación absoluta que le ha valido a Mite, junto con la versión de suspensión Tite, el Compasso D'Oro 2001, uno de los premios más prestigiosos del mundo. Una lámpara que se ha convertido en un icono en el panorama de la iluminación y que, en la versión de LED, expresa una luminosidad todavía más fascinante, con además la ventaja de contar con una tecnología amiga del medio ambiente.

Orbital —
Ferruccio Laviani, 1992
p. 124

FR → Orbital, une sculpture domestique. Est-ce une lampe, ou une installation artistique ? Considérée dès son lancement en 1992 comme un objet unique dans l'univers du design, possédant même un timbre à son effigie, Orbital est peut-être bien les deux à la fois. Une composition de silhouettes en verre sérigraphié, inspirées des

formes des galaxies, montées sur une structure en métal laqué et à l'esprit industriel. Blanche ou multicolore, Orbital diffuse un signal visuel unique dans l'espace environnant, avec une luminosité et une forme esthétique absolument originale. Les ampoules apparentes sont en effet un élément à part entière de l'esthétique de cet objet qui exprime toute la créativité et la culture typiquement italienne du design.

DE → Orbital – Skulptur für die eigenen vier Wände. Leuchte oder Kunstwerk? Vielleicht auch beides. Denn seit Orbital 1992 in den Handel kam, gilt die Leuchte in der Welt des Designs als absolut einzigartig und schaffte es sogar auf eine Briefmarke. Auf ihrem industriell wirkenden Gestell aus lackiertem Metall sind eine Reihe unterschiedlicher sieb-bedruckter Glasscheiben befestigt, deren Gestalt an die Form von Galaxien erinnert. Erhältlich in den Ausführungen weiß oder multicolor setzt Orbital in beiden Varianten spannende optische Akzente und verzaubert sowohl durch ihre sonderbare Gestalt als auch durch ihr ungewöhnliches Licht. Die sichtbar montierten Lampen sind wesentlicher Bestandteil des Designs der Leuchte, als Ausdruck typisch italienischer Kreativität und Formensprache.

ESP → Orbital, escultura doméstica. Es una lámpara o una instalación artística?

Stories

Lanzada en el 1992, considerada desde su aparición como un objeto único en el universo del diseño, representada incluso en un sello, *Orbital* es quizás las dos cosas. Una composición de plantillas en vidrio serigrafiado, inspiradas en las formas de las galaxias, sobre una estructura de metal esmaltado de sabor industrial. Blanca o multicolor, *Orbital* propaga una señal visual inconfundible en el espacio a su alrededor, con una luminosidad y una forma estética absolutamente especiales. Las bombillas a vista son en efecto un elemento que integra el diseño de esta obra, la expresión de una creatividad y una cultura del proyecto típicamente italiana.

Rituals —

Ludovica + Roberto
Palomba, 2013
p. 074

FR → *Rituals*, des lanternes modernes. Les lampes *Rituals*, dont la forme s'inspire des lanternes en papier de riz de la culture orientale, mais réalisées en verre soufflé, un matériau occidental précieux à la tradition millénaire, parlent un langage atemporel et sans frontière, celui de la beauté, de la poésie et de la liberté de combinaison et d'installation. Différentes mais complémentaires dans leur forme, elles forment une famille complète (des modèles à suspension aux versions de table, en passant par les

appliques et les plafonniers), qui permet de créer une multitude de compositions, avec la possibilité d'associer jusqu'à 9 suspensions grâce au cache multiple. Avec leur surface parcourue de fines incisions évoquant à la fois la texture du papier crêpé et le meulage du verre, elles émettent une lumière diffuse, intime et caressante, idéale pour accompagner les multiples rituels de la vie domestique contemporaine.

DE → *Rituals* – moderne Laternen. Angelehnt an die zarten Formen orientalischer Reispapierlaternen und gefertigt aus kostbarem, mundeblasenem Glas jahrtausendealter westlicher Tradition bestechen die Leuchten der Serie *Rituals* durch ihr zeitloses Design und ihre allgemeingültige Ästhetik. Ihre elegante, poetische Gestalt lässt sich gut kombinieren und fügt sich perfekt in jedes Ambiente. Ihre unterschiedlichen Formen ergänzen einander und erlauben eine Vielzahl interessanter Zusammenstellungen. Die Leuchtenfamilie umfasst Hänge-, Tisch-, Wand- und Deckenleuchten und bietet darüber hinaus die Möglichkeit, mittels Mehrfach-Baldachin Kompositionen mit bis zu 9 Hängeleuchten zu kreieren. Die zart gerillte Oberfläche von *Rituals* erinnert zugleich an zerknittertes Papier und geschliffenes Glas, sorgt für ein diffuses, warmes

und anheimelndes Licht und macht die Leuchte zu einem angenehmen Begleiter durch den modernen Wohnalltag.

ESP → *Rituals*, faroles modernos. Inspiradas en la forma a los ligeros faroles de papel de arroz de la cultura oriental, pero realizadas en precioso vidrio soplado, material de tradición occidental milenaria, las lámparas *Rituals* hablan un lenguaje sin tiempo y sin fronteras, el de la belleza, la poesía y la libertad de combinar y ambientar. Sus formas, distintas pero complementarias, generan una familia completa y permiten dar vida a múltiples composiciones, oscilando entre modelos de suspensión y de mesa, pared, techo, con además la posibilidad de componer hasta 9 suspensiones gracias al florón múltiple. Su superficie, recorrida por finas incisiones que recuerdan al mismo tiempo la ondulación del papel y el pulido del vidrio, propaga una luz suave, íntima y agradable, ideal para acompañar los múltiples rituales de la forma de vivir contemporánea.

Spokes —

Garcia Cumini, 2015
p. 234

FR → *Spokes* vient de l'observation des rayons d'une roue de bicyclette. Des tiges de métal minces qui satisfont une fonction bien précise, mais

en même temps représentent des lignes graphiques en mouvement. Grâce à un processus de pliage et de la répétition de ces signes, une forme douce et légère voit le jour, semblable à une lanterne orientale ou une volière pour oiseaux. À l'intérieur de cette structure suspendue, une double carte LED, développée par Foscarini, illumine l'espace en-dessous et l'environnement tout autour, avec une lueur chaude et solaire qui filtre vers l'extérieur, créant des jeux de pleins, de vides et d'ombres, en un motif géométrique et magique. En combinant différentes formes, couleurs et tailles, il est possible de créer une infinité de situations visuelles et lumineuses avec des textures visuelles qui sont projetées dans l'espace domestique ou collectif. La famille Spokes comprend la version Spokes L, encore plus grande et plus spectaculaire, idéale pour les grandes pièces avec un haut plafond.

DE → Die Idee zu Spokes lieferten die Speichen eines Fahrrads: Metalldrähte, die eine konkrete Funktion ausüben, zugleich aber ein Bild von Linien in Bewegung zeichnen. Durch Biegen und Vervielfachen dieser „Linien“ wurde eine weiche Form von bestechender Leichtigkeit geschaffen, die an eine orientalische Laterne oder einen Vogelkäfig erinnert. Im Inneren dieses frei hängenden Gestells befindet sich eine von Foscarini

entwickelte Doppelchip-LED, die den Bereich unter der Leuchte sowie den gesamten Raum in ein warmes, sonniges Licht taucht. Das Licht dringt durch die Speichen nach außen und lässt ein magisches, geometrisches Netz faszinierender Schattenspiele entstehen. Die Kombination unterschiedlicher Formen, Farben und Größen ermöglicht eine unendliche Vielzahl visueller Kompositionen und Beleuchtungslösungen, deren Schattenmuster in Wohnräumen wie öffentlichen Bereichen gleichermaßen verzaubern. Darüber hinaus umfasst die Serie Spokes auch das Modell Spokes L, das noch größer und eindrucksvoller ausfällt und sich damit ideal für große Räume mit hoher Decke eignet.

ESP → Spokes nace de la observación de los radios de una rueda de bicicleta. Finas varillas metálicas que tienen una función precisa, pero que al mismo tiempo representan líneas gráficas en movimiento. Con un proceso de curvatura y repetición de estas líneas, nace una forma suave y ligera, similar a una linterna oriental o a una jaula para pájaros. En el interior de esta estructura suspendida, una tarjeta LED doble especial, desarrollada por Foscarini, ilumina el espacio inferior y el ambiente alrededor, con una luz cálida y solar que filtra hacia el exterior, generando juegos de llenos, vacíos y sombras, en un mágico y geométrico retículo.

Combinando diversas formas, colores y tamaños, es posible crear una infinidad de situaciones visuales y luminosas, con texturas que se proyectan en el espacio doméstico o colectivo. La familia Spokes incluye la versión Spokes L, todavía más grande y escenográfica, ideal para los ambientes grandes y con techo alto.

Tartan —

Ludovica + Roberto Palomba, 2015
p. 246

FR → Le tartan est l'incomparable dessin des tissus de laine des kilts écossais, un croisement perpendiculaire de lignes qui génère des motifs géométriques toujours différents. En partant de cette inspiration, Ludovica et Roberto Palomba ont créé avec Foscarini une autre variation sur le thème de la lampe en verre soufflé, en poursuivant un parcours commencé en 1998 avec le modèle Dom et perpétué avec la famille des lampes Rituals. Dans la lampe à suspension Tartan, grâce à la technique du soufflage à la bouche à l'intérieur d'un moule avec des incisions particulières, le diffuseur en verre soufflé s'enrichit de lignes et de plis qui rappellent la trame du tissu écossais, générant un jeu graphique fait de lumières et d'ombres. La technique de l'acidage de la surface en verre offre aussi une sensation

Stories

de douceur matérielle qui rappelle le tissu. Riche dans le matériau et fascinant dans la personnalité, Tartan répand une luminosité chaude et tamisée dans l'environnement, filtrée par le verre opacisé et garantit aussi un bon éclairage orienté vers le bas.

DE → Tartan heißen die unverwechselbaren Karomuster schottischer Wollstoffkilts, deren senkrecht und waagrecht verlaufende Linien eine unendliche Vielzahl geometrischer Variationen ermöglichen. Sie dienen Ludovica und Roberta Palomba im Rahmen ihrer Zusammenarbeit mit Foscarini als Inspiration für ein neues Leuchtenmodell aus geblasenem Glas. Tartan versteht sich damit als Fortsetzung des 1998 mit Dom begonnenen Projekts, an das bereits die Leuchtenfamilie Rituals anknüpfte. Für die Fertigung der Hängeleuchte Tartan wird das Glas in eine Form mit speziellen Einkerbungen geblasen. Auf diese Weise bleibt auf dem mundgeblasenen Glas ein Muster aus Linien und Kerben zurück, das an einen klassischen Schottenrock erinnert und spannende Schattenspiele entstehen lässt. Die zusätzliche Behandlung der Glasoberfläche mit Säure verleiht dem Diffusor eine besonders „weiche“, stoffähnliche Optik. Tartan besticht durch ihr außergewöhnliches Material sowie ihren faszinierenden

Look und verströmt ein warmes, gedämpftes Licht. Das matte Glas wirkt als zusätzlicher Filter. Darüber hinaus sorgt die Leuchte zugleich für eine helle, direkte Beleuchtung nach unten.

ESP → El tartan es el inconfundible diseño de los tejidos de lana de los kilts escoceses, un cruce perpendicular de líneas que genera temas geométricos cada vez distintos. A partir de esta inspiración, Ludovica y Roberto Palomba han creado junto con Foscarini una ulterior variación en el tema de la lámpara en vidrio soplado, continuando un camino iniciado en el 1998 con el modelo Dom y continuado con la familia de las lámparas Rituals. En la lámpara de suspensión Tartan, gracias a la técnica del soplado a boca en el interior de un molde con incisiones particulares, el difusor en vidrio soplado se enriquece con líneas y pliegues que recuerdan la malla del tejido escocés, generando un juego gráfico hecho de luces y sombras. La técnica de la acidatura de la superficie de vidrio ofrece además una sensación de suavidad matérica que evoca el tejido.

La lámpara Tartan, con material de primera calidad y con una personalidad fascinante, propaga una luminosidad cálida y suave en el ambiente, filtrada por el vidrio opaco, y garantiza también una buena iluminación directa hacia abajo.

Tress —
Marc Sadler, 2008/2009
p. 132

FR → Tress est un croisement qui devient à la fois une structure porteuse et un décor, en donnant forme à une idée d'éclairage original, déjà iconique dans le paysage du design de la lumière. Pur jeu de pleins et de vides, de lumières et d'ombres, Tress est obtenue par un processus artisanal. L'enroulement de rubans en matériau composite, qui suit un motif apparemment aléatoire, permet d'obtenir une forme qui apporte à l'espace une atmosphère chaude et magique. Volcanique en rouge cramoisi, surprenante en bleu indigo et très actuelle en greige, un ton entre le gris et le beige, Tress offre de nouvelles nuances aux habitations et aux espaces collectifs. Les couleurs sont complétées par le blanc et le noir, composant ainsi un choix parmi cinq possibilités, chacune avec son propre charme. Le résultat est une grande famille de lampes, particulièrement adaptées aux grandes compositions multiples ou aux projets d'éclairage coordonnés.

DE → Tress besteht aus einem Geflecht, das zugleich tragende Struktur und Dekor ist. Diese Leuchte verkörpert die Idee der ursprünglichen Beleuchtung und ist schon eine Ikone im Lichtdesign. Tress spielt mit dem Kontrast zwischen Fülle und Leere, Licht und Schatten und wird

von Hand gefertigt. Mit Bändern aus Verbundmaterial, die in einem scheinbar zufälligen Muster gewickelt sind, entsteht eine Form, die im Raum eine warme und magische Atmosphäre verbreitet. Tress präsentiert sich vulkanähnlich in Karmesinrot, außergewöhnlich in Indigoblau oder brandaktuell in Greige – einem Farbton zwischen Grau und Beige – und bringt neue Nuancen in Wohnungen und öffentliche Räume. Neben den Farben ist Tress auch in Weiß und Schwarz erhältlich, es bieten sich somit fünf verschiedene Varianten, jede mit ihrem eigenen Reiz. Das Ergebnis ist eine große Lampenfamilie, ideal für Kompositionen aus mehreren Leuchten oder für Beleuchtungsprojekte.

ESP → Tress es una trama que se convierte al mismo tiempo en estructura portante y decoración, dando forma a una idea de iluminación original, que ya es un icono en el panorama del diseño de la luz. Puro juego de llenos y vacíos, luces y sombras, Tress se obtiene mediante un proceso artesanal. Del enrollamiento de cintas en material composite, siguiendo un motivo aparentemente casual, se obtiene una forma que difunde en el espacio una atmósfera cálida y mágica. Volcánica en rojo carmesí, sorprendente en azul índigo y sumamente actual en crudo – un tono entre el gris y el beige – Tress trae consigo nuevos

matices en los hogares y en los espacios colectivos. Los colores se acompañan con el blanco y el negro, componiendo una selección entre cinco diversas posibilidades, cada una con un encanto especial. El resultado es una amplia familia de lámparas, especialmente adecuada para grandes composiciones múltiples o para proyectos de iluminación coordinados.

Tuareg —
Ferruccio Laviani, 2013
p. 140

FR → Tuareg, une nouvelle forme d'éclairage. Une lampe sur pied inspirée des structures primitives réalisées par les civilisations tribales à partir de branches ou de cannes de bambou, pour donner naissance à une architecture surprenante, innovante, chaotique en apparence, mais en réalité extrêmement fonctionnelle. Tuareg est formée d'un ensemble de tubes en aluminium laqué de noir ou orange, composant une géométrie tridimensionnelle, avec des ampoules à LED pouvant s'allumer d'un simple geste grâce aux interrupteurs tactiles intégrés et s'orienter de manière indépendante à 360°, pour créer d'infinies possibilités d'éclairage.

La forme et la lumière, mais aussi la couleur, ont un rôle important puisque Tuareg présente un élégant habit noir adapté à toutes les occasions, ou un orange brillant évoquant

les contextes industriels, pour des environnements non conventionnels.

DE → Tuareg – neue Wege der Beleuchtung. Das Design der Bodenleuchte nimmt Anlehnung an primitiven Konstruktionen aus zusammengebundenen Zweigen oder Bambusrohren. Das Ergebnis ist eine außergewöhnliche, innovative Formensprache, scheinbares Chaos, das jedoch maximale Funktionalität garantiert. Tuareg besteht aus schwarz oder orangefarben lackierten Aluminiumrohren, die eine dreidimensionale geometrische Figur bilden.

Die darin untergebrachten LED-Lampen lassen sich dank integrierter Touch-Schalter mit einer einfachen Handbewegung ein- und ausschalten. Darüber hinaus können die Lampen unabhängig voneinander um 360° gedreht werden und ermöglichen damit eine Vielzahl unterschiedlicher Beleuchtungsszenarien. Aber nicht nur Form und Licht, auch der Wahl der Farbe kommt bei Tuareg eine entscheidende Rolle zu. Schwarz und elegant fügt sich die Leuchte dezent in jedes Ambiente, in leuchtendem Orange hingegen tritt ihr industrieller Charakter in den Vordergrund, ideal für den Einsatz in unkonventionellen Umgebungen.

ESP → Tuareg, nueva forma de iluminación. Una lámpara de pie que se inspira

Stories

en las primitivas estructuras realizadas en las culturas tribales, uniendo ramas o cañas de bambú, para dar vida a una arquitectura sorprendente, innovadora, sólo aparentemente caótica pero en realidad sumamente funcional. Tuareg está formada por tubos en aluminio, pintados de negro o naranja, que componen una geometría tridimensional, con luces de LED que se pueden encender con un simple gesto, gracias a los interruptores “touch” integrados, y que se pueden orientar a 360° de forma independiente, para crear infinitas posibilidades de iluminación. No sólo la forma y la luz sino también el color tiene un papel importante en Tuareg: un elegante traje negro adecuado para cualquier ocasión, o bien un naranja brillante que recuerda situaciones industriales, para ambientes no convencionales.

Twiggy —
Marc Sadler, 2006
p. 146

FR → Twiggy, tout simplement géniale. Imaginez une ligne fine, flexible et arquée qui, comme par magie, soutiendrait dans l'air un large diffuseur pouvant éclairer simultanément vers le bas grâce à une lumière directe, et vers le haut grâce à une lumière diffuse. C'est fait ? Et bien vous venez d'imaginer Twiggy, une lampe qui allie la recherche d'une simplicité absolue aux possibilités

offertes par les matériaux contemporains. Twiggy se plie harmonieusement telle une canne à pêche. Elle est par ailleurs réglable en hauteur pour répondre à tous les besoins. À côté d'un canapé ou d'une chaise-longue, au-dessus d'une table ou d'un bureau, seule, telle une marque unique et reconnaissable dans l'espace, ou en composition, elle se distingue toujours par une personnalité et une flexibilité extrême.

DE → Twiggy – einfach genial. Eine hauchdünne Linie, elastisch geschwungen, die wie von Zauberhand einen großen Diffusor in der Luft hält, aus dem direktes Licht nach unten und diffuses Licht nach oben strahlt. Das ist Twiggy. Elegante Symbiose maximaler Schlichtheit mit den Möglichkeiten moderner Materialien. Wie eine Angelrute neigt sich Twiggy sanft nach vorne und lässt sich dabei je nach Bedarf in der Höhe verstellen. Wunderschön neben einem Sofa oder einer Chaiselongue, über einem Tisch oder Arbeitsplatz macht die Leuchte sowohl allein, als optischer Akzent im Raum, wie auch in effektvollen Kompositionen schöne Figur und überzeugt durch ihre außergewöhnliche Formensprache und Flexibilität.

ESP → Twiggy, simplemente genial. Imagínese una línea muy fina, flexible y arqueada que, como por arte de magia sostiene en el aire un amplio

difusor que ilumina al mismo tiempo hacia abajo con una luz directa y hacia arriba con una luz suave. Ya está? Pues bien, acaba de imaginarse a Twiggy, una lámpara que une la búsqueda de una sencillez absoluta con las posibilidades ofrecidas por los materiales contemporáneos. Como una caña de pescar, Twiggy se dobla de forma armoniosa y además se puede regular en altura para satisfacer las necesidades de ambientación. Al lado de un sofá o una tumbona, encima de una mesa o un escritorio, sola como un rasgo inconfundible en el espacio o en escenográficas composiciones, pero siempre con una excepcional personalidad y flexibilidad.

Company —
p. 004

FR → Foscarini, passionate about light.

Chaque modèle Foscarini a une histoire différente et un caractère spécial, qui traduit une idée de lumière dans un espace éclairé.

Derrière chacun d'eux se cachent des personnes qui, chaque jour, travaillent avec le cœur, la tête et les mains. En imaginant de nouvelles manières d'allumer l'atmosphère. En recherchant des formes simples mais incomparables, dans lesquelles l'innovation technologique est toujours présente, sans étalage.

Building design culture.

En plus d'interpréter le design de la lumière, Foscarini soutient la culture du projet sous toutes ses formes. À travers le bookzine *Inventario*, fondé, promu et soutenu par l'entreprise, dirigé par Beppe Finessi : un regard sur la scène du design, de l'architecture et de l'art, complètement indépendant et libre des logiques d'entreprise, récompensé avec le *Compasso d'Oro ADI*. Et avec des installations créatives et dotées d'une valeur artistique, du projet photographique *Twice Light* à New York à la célébration des 25 ans de *Lumière* à la Triennale de Milan : un work in progress jamais nombriliste, toujours stimulant et émouvant.

DE → Foscarini, passionate about light.

Jede Foscarini-Leuchte hat ihre eigene Geschichte, ihren eigenen Charakter und erhellt den Raum auf ihre eigene Weise. Hinter jeder dieser Leuchten stehen Menschen, die täglich mit Kopf, Herz und Hand an ihrer Umsetzung arbeiten. Die immer neue Ideen entwickeln, wie mit Beleuchtung auch Atmosphäre geschaffen werden kann. Mit einfachen, aber unverwechselbaren Formen und konsequentem Einsatz innovativer Technologien – ohne diese jedoch ostentativ zur Schau zu stellen.

Building design culture.

Neben der kreativen Auseinandersetzung mit Lichtdesign tritt Foscarini auch aktiv als Förderer der Designkultur in all ihren Ausdrucksformen auf. Etwa mit dem von Foscarini ins Leben gerufenen, vertriebenen und geförderten Bookzine-Projekt *Inventario* unter der Leitung von Beppe Finessi, das unabhängig und frei von unternehmenspolitischen Einflüssen einen neugierigen Blick in die Welt des Designs, der Architektur und der Kunst wirft und dafür auch bereits mit dem *Compasso d'Oro ADI* ausgezeichnet wurde. Aber auch mit kreativen und künstlerischen Installationen – vom Fotoprojekt *Twice Light* in New York bis hin zur Feier 25 Jahre *Lumière* auf der Triennale in Mailand. Inspirierende, bewegende Projekte, die sich

stets weiterentwickeln und dabei gekonnt auf unnötige Nabelschau verzichten.

ESP → Foscarini, passionate about light.

Cada modelo Foscarini tiene una historia distinta y un carácter especial, que traduce una idea de luz en un espacio iluminado. Detrás de ello existen personas que trabajan cada día con el corazón, la cabeza y las manos. Imaginando nuevas formas de encender una atmósfera. Buscando formas sencillas pero inconfundibles, en las que la innovación tecnológica se encuentra siempre presente, sin ostentación.

Building design culture.

Además de interpretar el diseño de la luz, Foscarini sostiene la cultura del proyecto en todas sus expresiones. A través del bookzine *Inventario*, fundado, promovido y apoyado por la empresa, y dirigido por Beppe Finessi; una mirada a la escena del diseño, de la arquitectura y del arte, completamente independiente y libre de lógicas empresariales, premiado con el *Compasso d'Oro ADI*. Y con instalaciones creativas y de valor artístico, del proyecto fotográfico *Twice Light* en Nueva York a la celebración de los 25 años de *Lumière* en la Trienal de Milán: un work in progress nunca autoreferencial, siempre estimulante y emocionante.

Legenda — Key



LED

Identifica i modelli con LED integrati e già inclusi, risultato della progettazione ed ingegnerizzazione Foscarini.

It marks the models with integrated LED included in the lamp, which is the result of Foscarini designing and engineering.

Identifie les modèles avec source LED intégrée, résultant de la conception et de l'ingénierie Foscarini.

Kennzeichnet die Modelle mit integrierter LED-Quelle, stammend aus der Foscarini Entwurfs-und Entwicklungsarbeit.

Identifica los modelos con LED integrados y ya incluidos, resultado del proyecto y de la ingeniería Foscarini.



CSQ - IQNET

Marchio valido in tutto il mondo, certifica che l'azienda Foscarini attua un sistema di gestione della qualità conforme alla normativa UNI EN ISO 9001:2008, per garantire un elevato standard qualitativo nella progettazione, sviluppo, fabbricazione e commercializzazione dei propri prodotti.

The CSQ-IQNET label is valid all over the world. It certifies that Foscarini runs a quality management system which complies with the UNI EN ISO 9001:2008 standard, to guarantee a high quality level for what concerns project, development, production and distribution of its products.

Le label CSQ-IQNET est reconnu dans le monde entier et certifie que Foscarini met en place un système de gestion de la qualité conforme à la norme UNI EN ISO 9001:2008 pour garantir un niveau de qualité élevé dans l'ensemble de la conception, développement, production et vente de ses appareils d'éclairage.

Das CSQ-IQNET Prüfzeichen ist weltweit anerkannt und zertifiziert, daß Foscarini ein der Norm UNI EN ISO 9001:2008 entsprechendes Qualitätssystem anwendet, um ein hohes Qualitätsniveau in Hinblick auf Planung, Entwicklung, Produktion und Vertrieb der eigenen Produkte zu gewährleisten.

La marca CSQ-IQNET es valida en todo el mundo y certifica que Foscarini tiene un sistema de calidad conforme a la norma UNI EN ISO 9001:2008 para garantizar un elevado nivel de calidad en la proyección, el desarrollo, la producción y la venta de sus productos.



CSQ ECO

Marchio valido in tutto il mondo, certifica che l'azienda Foscarini attua un sistema di gestione ambientale conforme alla normativa UNI-EN ISO 14001:2004 per garantire l'impegno dell'azienda ad operare nel rispetto dell'ambiente e con l'obiettivo continuo di ridurre l'impatto delle proprie attività.

This label is valid all over the world. It certifies that Foscarini runs an environmental management system which complies with the UNI EN ISO 14001:2004 standard in order to guarantee company's commitment to continual improvement of its environmental performances.

Le label est reconnu dans le monde entier et certifie que Foscarini met en place un système de management environnemental conforme à la norme UNI EN ISO 14001:2004 pour garantir l'engagement de l'entreprise à agir dans le respect de l'environnement avec le but de réduire constamment l'impacte environnemental de ses activités.

Das Prüfzeichen ist weltweit anerkannt und zertifiziert, daß Foscarini ein der Norm UNI EN ISO 14001:2004 entsprechendes Umweltmanagementsystem anwendet, um die betriebliche Verpflichtung zum Umweltschutz, mit dem Ziel der stetigen Verbesserung ihrer Umweltleistungen zu be-

La marca es válida en todo el mundo y certifica que Foscarini tiene un sistema de gestión ambiental conforme a la norma UNI EN ISO 14001:2004 para garantizar el compromiso de la empresa a trabajar respetando el ambiente y con el objetivo de seguir reduciendo el impacto de sus actividades.



ENEC

Il marchio ENEC (Certificazione Elettrica relativa alle Norme Europee) è un marchio volontario rilasciato da enti terzi. Certifica che il prodotto è conforme e rispetta i requisiti proposti dalla norma EN 60598 ed è progettato e realizzato in aziende il cui sistema di gestione della qualità soddisfa i requisiti della norma UNI EN ISO 9001.

The label ENEC (Electrical Certification concerning European Standard) is a voluntary label granted by third organizations. It certifies that a product complies with the EN 60598 standards and has been designed and manufactured by companies with an approved UNI EN ISO 9000 quality control system.

Le label ENEC (Certification Electrique relative aux Normes Européennes) est volontaire et issu par des établissements tiers. Il certifie qu'un produit est conforme à la norme EN 60598 et qu'il a été conçu et fabriqué par des entreprises dotées d'un système de qualité conforme aux normes UNI EN ISO 9000.

Das Prüfzeichen ENEC (Elektrische Zertifizierung in Bezug auf die Europäischen Normen) ist eine freiwillige Zertifizierung die von Dritten gewährt wird. Es zertifiziert, dass ein Produkt den Vorgaben der EN 60598 Norm entspricht und von Firmen entwickelt und hergestellt wird, deren Qualitätsmanagement den Normen UNI EN ISO 9000 entspricht.

La marca ENEC (Certificación Electrica relativa a las normas Europeas) es voluntaria y entregada por empresas terceras. Certifica que un producto cumple a la norma EN 60598 y ha sido proyectado y realizado por empresas con un sistema de calidad conforme a las normas UNI EN ISO 9000.

Legenda — Key



Classe I

Apparecchio in classe I°: è obbligatoria la connessione al conduttore di protezione giallo/verde (messa a terra).

Class I° luminaire: it's necessary to connect the device to the yellow/green protective conductor (earthing).

Il est obligatoire la connexion au conducteur de protection jaune/vert (mise à la terre).

Alle berührbaren Metallteile sind elektrisch leitend mite inander verbunden und werden mit dem Netz-Schutzritter verbunden.

Aparato en el que: es obligatoria la conexión al conductor de protección Amarillo/verde (toma de tierra).



cULus

Certifica che il prodotto è conforme e rispetta i requisiti proposti dalle normative nordamericane, viene rilasciato dall'UL, organizzazione indipendente leader nel settore della certificazione di sicurezza dei prodotti destinati al mercato Nordamericano.

Certifies that the product is conform to the North American standards, and is issued by UL, independent organisation leader in the field of products safety certification for the North American market.

Certifie que le produit est conforme aux normes nordamericaines et est issu par UL, une organisation indépendante leader dans le secteur de la certification de sécurité des produits destinés au marché nordaméricain.

Zertifiziert, dass das Produkt den nordamerikanischen Normen entspricht und wird von UL, einer unabhängigen, im Bereich der Produktsicherheitszertifizierung für den nordamerikanischen Markt führenden Organisation ausgestellt.

Certifica que el producto cumple a las normas norteamericanas y es entregado por UL, la mas importante organización independiente de certificación de seguridad de los productos para el mercado estadounidense y canadense.



Classe II

Apparecchio in cui la protezione contro la scossa elettrica si basa unicamente sul doppio isolamento e/o isolamento rinforzato in ogni parte e senza dispositivo di messa a terra.

Light fittings whose safety is guaranteed only by the double and/or reinforced insulation of all parts, with no earth.

Appareil où la sécurité électrique est garantie par un double niveau d'isolation de toutes les parties sans dispositif de mise à la terre.

Bei Leuchten der Klasse II ist der Berührungsschutz durch eine doppelte und /oder verstärkte Schutzisolierung aller spannungsführenden Teile gegeben, ohne Erdung.

Aparatos con protección contra descargas eléctricas basados en un doble aislamiento o un aislamiento reforzado, sin dispositivo de toma de tierra.



CCC

The China Compulsory Certificate mark certifies that the product is conform to the Chinese standards.

The China Compulsory Certificate mark certifies that the product is conform to the Chinese standards.

The China Compulsory Certificate mark certifies that the product is conform to the Chinese standards.

The China Compulsory Certificate mark certifies that the product is conform to the Chinese standards.

The China Compulsory Certificate mark certifies that the product is conform to the Chinese standards.



Americans Disability ACT

Serie di normative che regolano l'arredo di edifici pubblici a favore dei portatori di handicap.

Certification that confirms accessibility to places of public accommodation and commercial facilities by individuals with disabilities.

Une série de normes concernant la décoration des collectivités en faveur des handicapés.

Eine Reihe von Vorschriften für öffentliche Gebäude zugunsten der Behinderten.

La Ley de Estadounidenses con Discapacidades incluye una serie de normas que regulan la decoración de los edificios públicos a favor de los minusválidos.

Legenda — Key

IP

IP Protection Degree

IP20: apparecchio protetto contro la penetrazione di corpi solidi di dimensioni maggiori a 12mm e non protetto nei confronti dei liquidi.

IP44: apparecchio protetto contro la penetrazione di corpi solidi di dimensioni maggiori a 1mm e protetto contro gli spruzzi d'acqua.

IP65: apparecchio totalmente protetto contro la polvere e protetto contro i getti d'acqua.

IP20: protected against the penetration of solid objects greater than 12 mm and non protected against liquids.

IP44: protected against the penetration of solid objects greater than 1 mm and protected against splashing water.

IP65: dust-tight and protected against water jets.

IP20: protégé contre la pénétration des corps solides aux dimensions supérieures à 12 mm, sans protection contre les liquides.

IP44: protégé contre la pénétration des corps solides aux dimensions supérieures à 1 mm et protégé contre les projections d'eau de toutes directions.

IP65: protégé contre la pénétration de poussière et protégé contre les jets d'eau de toutes directions.

IP20: Gegen das Eindringen von Festkörpern größer als 12 mm geschützt, ohne Schutz gegen Flüssigkeiten.

IP44: Gegen das Eindringen von Festkörpern größer als 1 mm und gegen das Eindringen von Spritzwasser geschützt.

IP65: Staubdicht und gegen das Eindringen von Spritzwasser geschützt.

IP20: protección contra la penetración de cuerpos sólidos de un tamaño superior a 12 mm, sin protección contra líquidos.

IP44: protección contra la penetración de cuerpos sólidos de un tamaño superior a 1 mm y protección contra las salpicaduras de agua.

IP65: protección total contra el polvo y protección contra los chorros de agua.

Energy Efficiency Classes

Le classi di efficienza energetica degli apparecchi luminosi, definite dal reg. UE n.874/2012, sono determinate in base all'Indice di Efficienza Energetica (IEE) e spaziano in un intervallo compreso tra A++ (efficienza massima) ed E (efficienza minima).

The energy efficiency classes for light appliances set out by EU regulation no. 874/2012 are calculated on the basis of the Energy Efficiency Index (EEI) and range between A++ (maximum efficiency) and E (minimum efficiency).

Les classes d'efficacité énergétique des appareils lumineux, définies par le règlement UE n° 874/2012, sont déterminées en fonction de l'indice d'efficacité énergétique (IEE) et représentent une échelle allant d'A++ (efficacité maximale) à E (efficacité minimale).

Energie Effizienz Klaisen. Die von der EU-Verordnung 874/2012 definierten Energieeffizienzklassen für Leuchten werden auf Grundlage des Energieeffizienzindex (EEI) ermittelt und reichen von A++ (maximale Effizienz) bis E (geringste Effizienz).

Las clases de eficiencia energética de los aparatos luminosos, definidas por el reglamento UE n.º 874/2012, están determinadas según el Índice de Eficiencia Energética (IEE) y oscilan en un intervalo comprendido entre A++ (eficiencia máxima) y E (eficiencia mínima).

Colophon

Foscarini SpA

via delle Industrie 27
30020 Marcon / Venezia / Italy
T +39 041 595 3811
foscarini@foscarini.com

Foscarini Inc

20 Greene Street, New York
NY /10013 / USA
T +1 212 247 2218
foscarini.inc@foscarini.com

Foscarini Japan K.K.

Oak Minami-Azabu Building, 19-23,
Minami-Azabu 3-chome,
106-0047 Minato-ku / Tokyo / Japan
foscarini.jpn@foscarini.com

Foscarini Spazio Brera

via Fiori Chiari 28 /
via Pontaccio 19
20121 / Milano / Italy
T +39 02 870 71320
spaziobrera@foscarini.com

Foscarini Spazio Soho

20 Greene Street, New York
NY /10013 / USA
T +1 212 257 4412
spaziosoho@foscarini.com

Azienda certificata

UNI EN ISO 9001

UNI EN ISO 14001

edizione 01.2017

Concept and graphic design:

Designwork

art direction: Artemio Croatto

art work: Erika Pittis / Designwork

photography:

Andrea Ferrari,

Massimo Gardone / Azimut,

Kasia Gatkowska,

Alessandro Paderni,

Tommaso Sartori,

Gianluca Vassallo.

colour separation:

Luce, Udine

made and printed in Italy

by OGM, Padova

foscarini.com

FOSCARINI