

THE LIGHTING MAKERS 2018



**STUDIO
ITALIA DESIGN**
LIGHTING MAKERS



A history of light, glass, metal

1950. Italy. Venice. The town of Marcon and the island of Murano are just a few kilometres apart. Angelo Toso goes through those few kilometres almost every day from his workshop of artistic chandeliers to the shops of Murano glass masters to steal the secrets of their glass, hand blown in their furnaces.

It's a journey of pure passion, artistic affinities, where light meets matter, glass joins metal – brass, aluminium, steel – and tradition welcomes the future. The beginning of a great story: Studio Italia Design's story.

From Italy to the world over, a constant evolution.

This is the main path of "made in Italy", chosen and followed by three generations, experimenting each year with new processing techniques, technologies, designs, precious materials and a series of exclusive collaborations to create unique and ingenious luminaires: by form, content, aesthetics and functionality.

It's the path of success, that from Venice leads Studio Italia Design to shift attention to foreign markets, more than 90 countries the world over: to become one of Italian lighting's most internationally developed brands.

Make room for creativity. In each and every form.

Every path has its limits and to overcome them you need eyes, sensibility, skills and different emotions to decipher an ever changing world. For this reason Studio Italia Design chooses to partner with famous designers, researchers and engineers from a variety of nationalities and backgrounds. A selected group of creative people that together with the firm reinterprets the objects as true interior pieces where the light source plays freely with volumes, reflections, transparencies, lines and all the shades of the materials. Infinite new collections joined together by a common thread of manufacturing excellence.

Lighting every need in modern living.

The path of innovation also leads to extreme customisation: an answer to the needs that come with new lifestyles thanks to inventive new products custom-made for a variety of different interiors and tailored solutions developed with the leaders in contemporary architecture.

Another new frontier travelled by Studio Italia Design on the path of experience: merging different materials, classicism and avant-garde, craftsmanship and technology. A look at the path where it all began and the excitement in the next step.

Una storia di luce, vetro, metallo.

1950. Italia. Venezia. Il paese di Marcon e l'isola di Murano distano pochi chilometri. E sono quelli che Angelo Toso percorre quasi ogni giorno dalla sua bottega artigiana di lampadari artistici ai laboratori dei maestri vetrai muranesi, per carpire tutti i segreti del vetro soffiato a bocca nelle fornaci.

È un viaggio di pura passione, affinità artistiche, dove la luce incontra la materia, il vetro si unisce al metallo - l'ottone, l'alluminio, l'acciaio - e la tradizione sorride al futuro. L'inizio di una grande storia: quella di Studio Italia Design.

Dall'Italia al mondo, evoluzione continua.

Questa è la strada maestra del made in Italy, quella che tre generazioni scelgono di seguire sperimentando ogni anno nuove tecniche di lavorazione, tecnologie, linee, materiali pregiati, e una serie di collaborazioni esclusive nella creazione di lampade uniche e innovative: per forma e contenuto, estetica e funzionalità.

È la via del successo, che da Venezia porta Studio Italia Design ad accendere l'interruttore sull'estero, in oltre 90 paesi in tutto il mondo: per diventare oggi uno dei brand italiani nel settore dell'illuminazione più evoluti a livello internazionale.

Spazio alla creatività. In tutte le sue forme.

Ogni strada ha i suoi confini e per superarli servono occhi, sensibilità, competenze ed emozioni diverse capaci di interpretare un mondo che cambia. Così Studio Italia Design ha deciso di farsi accompagnare da designer, ricercatori e progettisti famosi di varie nazionalità e background. Un pool di creativi che insieme al brand reinterpretano gli oggetti come veri e propri elementi di arredo, dove la sorgente luminosa è libera di giocare con i volumi, i riflessi, le trasparenze, le linee e tutte le sfumature della materia. Infinite nuove collezioni unite dall'eccellenza produttiva di sempre.

Per illuminare ogni esigenza dell'abitare.











Il percorso dell'innovazione passa anche attraverso la massima personalizzazione: la possibilità di rispondere ai nuovi stili di vita grazie a prodotti pensati ad hoc per i vari contesti dell'abitare e a soluzioni su misura studiate insieme ai protagonisti dell'architettura contemporanea.

Ancora una nuova frontiera che Studio Italia Design percorre nel solco della sua esperienza: integrando materiali eterogenei, classicismo e avanguardia, artigianato e tecnologia. Uno sguardo a quella strada dove tutto è iniziato e l'entusiasmo di raggiungere la prossima destinazione.

THE
LIGHTING
MAKERS
2018

STUDIO
ITALIA DESIGN
LIGHTING MAKERS

ANNO | YEAR

<p>Edison inventa la lampadina ad incandescenza. Edison invented the first incandescent light bulb.</p>	○	<p>1878 </p>
<p> 1901</p>	○	<p>Vengono sviluppate le prime lampade a scarica a vapori di mercurio. The first mercury vapour discharge lamps were developed.</p>
<p>Viene brevettata la prima lampadina ad uso commerciale. The first light bulb was patented for commercial use.</p>	○	<p>1910 </p>
<p> 1926</p>	○	<p>Viene brevettata la lampada a fluorescenza. The fluorescent lamp was patented.</p>
<p>Viene brevettato il LED. LED was patented.</p>	○	<p>1962 </p>
<p> 1978</p>	○	<p>Appaiono le prime lampadine a basso consumo (CFL). The first energy saving light bulbs (CFL) was appeared.</p>
<p>Viene inventata la prima lampadina LED. The first LED light source was developed.</p>	○	<p>1993 </p>
<p> 2007</p>	○	<p>Appaiono le prime lampadine a LED retrofit. The first retrofit LED bulbs appeared.</p>
<p>Studio Italia Design propone le prime lampade con chip integrato LED a tensione di rete. Studio Italia Design offered its first lighting fixtures with integrated mains voltage LED chip.</p>	○	<p>2015 </p>
<p></p>	○	<p>Il 90% della collezione SID utilizza la tecnologia LED a tensione di rete. 90% of SID collection uses mains voltage LED technology.</p>
<p>SID lancia i propri moduli LED a tensione di rete studiati e realizzati internamente (Made in Italy). SID launches mains voltage LED modules designed and manufactured in house (Made in Italy).</p>	○	<p>2016 </p>
<p> 2017-2018</p>	○	<p>SID lancia i moduli LED a tensione ad alta efficienza (Made in Italy). SID launches high efficiency mains voltage LED modules (Made in Italy).</p>

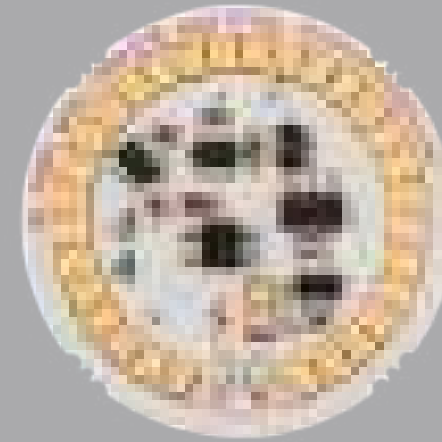

9W
2700K 900lm CRI92
3000K 950lm MacAdam 3-Step

Dimmerabile con varialuce a taglio di fase
Dimmable with phase cut dimming

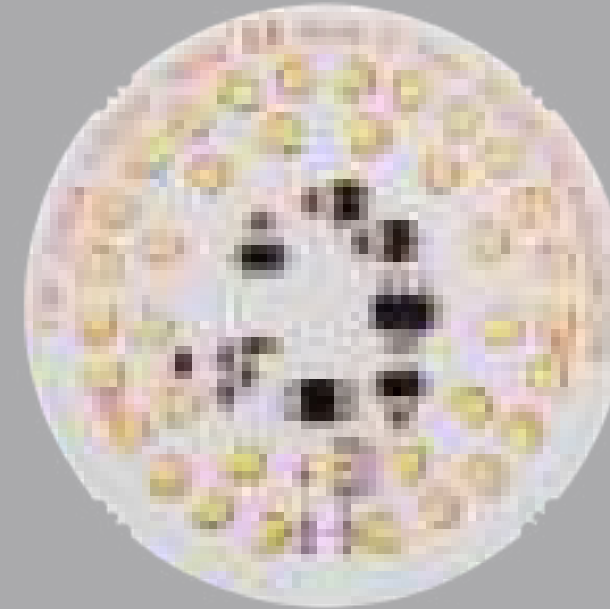

17W
2700K 1700lm CRI92
3000K 1800lm MacAdam 3-Step

Dimmerabile con varialuce a taglio di fase
Dimmable with phase cut dimming



Cos'è il MacAdam Step?
Scansiona il QR Code e scopri subito!
What is MacAdam Step?
Scan the QR Code and find out now!



Cos'è il CRI?
Scansiona il QR Code e scopri subito!
What is CRI?
Scan the QR Code and find out now!



Il kelvin (K) è l'unità di misura del colore della luce. Scopri di più!
The kelvin (K) is the light color unit measurement. Find out more!



Il lumen (lm) è l'unità di misura del flusso luminoso. Scopri di più!
The lumen (lm) is the unit of the luminous flux. Find out more!

Indice Alfabetico/ Alfabetic Index



A-Tube 138



A-Tube Nano 112



A-Tube Nano Duo 126



Beetle 340



Blow 330

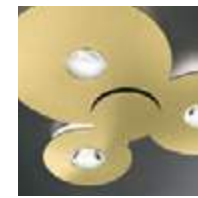

Bugia 52



Frozen 106



Kelly 236



Kelly Cluster 260



Laser Cube 176



Maggio 278



Make-Up 334



Millo 350



Nautilus 24



Nostalgia 286



Pin-Up 90



Puzzle 146



Puzzle Round 164



Puzzle Twist 158



Rain 80



Random 310



Shelf 100



Sky-Fall 10



Spider 64



Sug gas a 224



Thor 180



Valentina 188



Vapor 354

THE LIGHTING MAKERS 2018

PENDANT



A-Tube 138
A-Tube Nano 112
A-Tube Nano Duo 126
Kelly 236
Kelly Cluster 260
Maggio 278
Nautilus 24
Nostalgia 286
Rain 80
Random 310
Sky-Fall 10
Spider 64
Sugegasa 224
Valentina 188



WALL

Beetle 340
Kelly 236
Laser Cube 176
Make-Up 334
Millo 350
Nautilus 24
Pin-Up 90
Puzzle 146
Puzzle Round 164
Puzzle Twist 158
Shelf 100
Thor 180
Valentina 188

CEILING



A-Tube 138
Beetle 340
Bugia 52
Frozen 106
Make-Up 334
Millo 350
Nautilus 24
Pin-Up 90
Puzzle 146
Puzzle Round 164
Puzzle Twist 158
Thor 180

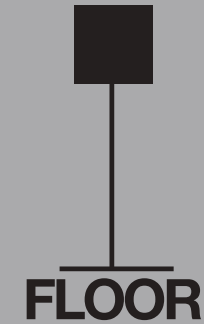

FLOOR

Kelly 236
Vapor 354

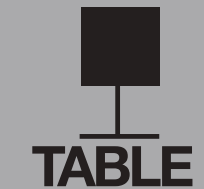

TABLE

Blow 330
Valentina 188

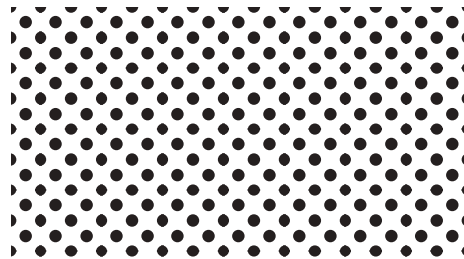
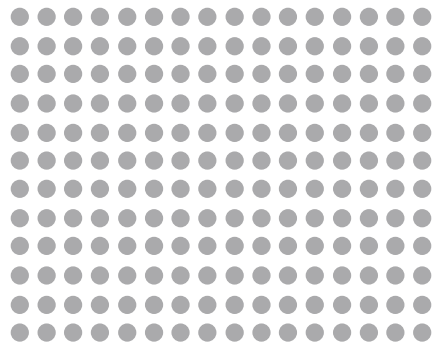

SKYFALL

design: Studio Italia Design 2014

THE SKY-FALL PENDANT IS AN ELEGANT PIECE THAT MARRIES ANCIENT MURANO GLASS WITH INNOVATIVE LED TECHNOLOGY IN A TIMELESS FASHION. MOUNTED TO THE CEILING BY A DOME-SHAPED CANOPY, THE DIFFUSER OF THIS MODERN PENDANT LIGHT IS HANDMADE AND AVAILABLE IN THE FOLLOWING FINISHES: CRYSTAL, GLOSSY COPPER METALLIZED, CHROME AND ROSE GOLD BLOWN GLASS AND BOASTS A PURE, SHAPELY FORM. THE TWO LED LIGHT SOURCES PROVIDES BOTH DIRECT AS WELL AS INDIRECT LIGHT. TWO VERTICAL FILAMENTS ARE VISIBLE THROUGH THE CLEAR GLASS INSIDE THE DIFFUSER.

LA FORMA RICORDA I DECANTER DEI VINI PREGIATI IN PREZIOSO VETRO SOFFIATO CHE SI FONDONO CON IL PROGRESSO, UNENDO COSÌ LA MAESTRIA NELL'ARTE DEL VETRO CON LE NUOVISSIME TECNOLOGIE LED. SOSPENSIONE CHE NON SOLO INCANTA DI RICORDI MA CHE EMOZIONA, SINGOLARMENTE O IN COMPOSIZIONI MULTIPLE.





SKYFALL
STUDIO
ITALIA
DESIGN





SKYFALL







SKY-FALL

MODELLO | MODEL LAMPADINA | LAMP MONTATURA | FRAME DIFFUSORE | DIFFUSER CODICE | CODE

Sky-Fall Medium Pendant | Sospensione

	LED COB 2700K 2 x 10W 1815 lm 350 mA CRI 95 MacAdam 3-Step	Cromo Chrome	Cristallo Crystal	148001	
			Rame Lucido Glossy Copper	148002	
			Cromo Chrome	148005	
			Oro Rosa Rose Gold	148008	
LED and DRIVER included		Metallo Metal	Vetro Soffiato Blown Glass		
CE Energy saving DIM TRIAC		Peso netto: 1.65 Kg Net Weight:	Confezione Packaging Peso Lordo: 3.14 Kg Gross Weight:	n. Colli: 2 n. Pack:	Volume m ³ : 0.059 Volume m ³ :

Sky-Fall Large Pendant | Sospensione

	LED COB 2700K 2 x 10W 1815 lm 350 mA CRI 95 MacAdam 3-Step	Cromo Chrome	Cristallo Crystal	148003	
			Rame Lucido Glossy Copper	148004	
			Cromo Chrome	148006	
			Oro Rosa Rose Gold	148007	
LED and DRIVER included		Metallo Metal	Vetro Soffiato Blown Glass		
CE Energy saving DIM TRIAC		Peso netto: 3.05 Kg Net Weight:	Confezione Packaging Peso Lordo: 6 Kg Gross Weight:	n. Colli: 2 n. Pack:	Volume m ³ : 0.116 Volume m ³ :

SKY-FALL

system

MODELLO | MODEL INFO | INFO COLORE | COLOR SISTEMA | SYSTEM CODICE | CODE

Sky-Fall Linear Track Short Track | Binario

	Binario lineare multiplo mod. Sky-Fall massimo 3 sospensioni Multiple linear track mod. Sky-Fall max 3 suspensions	Bianco Opaco 9010 Matte White 9010	Sky-Fall system	154031	
					Metallo Metal
CE Energy saving		Peso netto: 4.6 Kg Net Weight:	Confezione Packaging Peso Lordo: 5.41 Kg Gross Weight:	n. Colli: 1 n. Pack:	Volume m ³ : 0.019 Volume m ³ :

Sky-Fall Linear Track Long Track | Binario

	Binario lineare multiplo mod. Sky-Fall massimo 5 sospensioni Multiple linear track mod. Sky-Fall max 5 suspensions	Bianco Opaco 9010 Matte White 9010	Sky-Fall system	154032	
					Metallo Metal
CE Energy saving		Peso netto: 8.2 Kg Net Weight:	Confezione Packaging Peso Lordo: 9.45 Kg Gross Weight:	n. Colli: 1 n. Pack:	Volume m ³ : 0.031 Volume m ³ :

Sky-Fall Wall Wall Bracket | Rosone Parete

	Rosone a parete mod. Sky-Fall Wall bracket mod Sky-Fall	Cromo Chrome	Sky-Fall system	154039	
					Metallo Metal
CE Energy saving		Peso netto: 0.4 Kg Net Weight:	Confezione Packaging Peso Lordo: 0.83 Kg Gross Weight:	n. Colli: 1 n. Pack:	Volume m ³ : 0.005 Volume m ³ :

Note | Notes: **Sky-Fall Linear Track** - I Binari sono utilizzabili solo con le sospensioni Sky-Fall che dovranno essere separate dai rosoni ed installate sui binari. Per ogni sospensione dovrà essere installato nel binario il rispettivo trasformatore rimosso dal rosone originale.

Sky-Fall Wall - Entrambi gli accessori nelle due diverse lunghezze sono inclusi nella confezione con il supporto a parete.

Sky-Fall Linear Track - Lights Traks are only for Sky-Fall pendants. Each pendant should be separated from the canopy and installed on the track. Each pendant should be installed on the track using the transformer removed from the original canopy.

Sky-Fall Wall - Both accessories in the two available lengths are supplied in the box with the wall bracket.

Note | Notes:

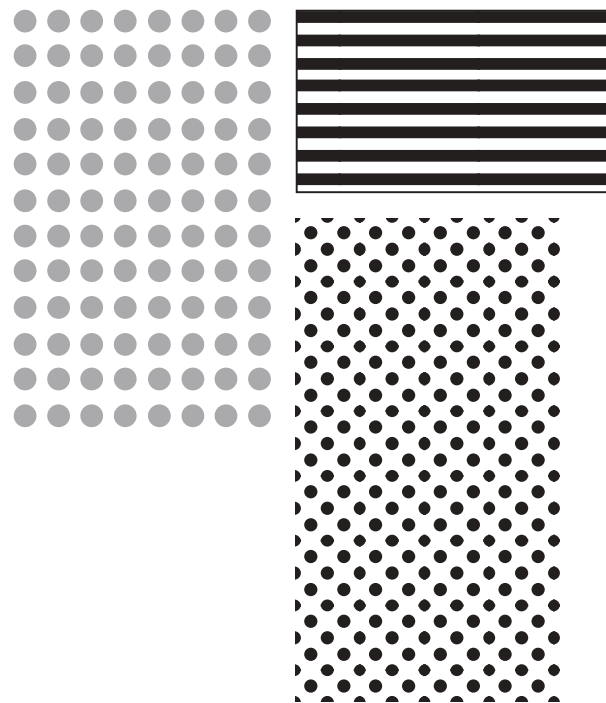

NAUTILUS

design: Andrea Tosetto 2017

NAUTILUS EXPRESSES THE PERFECT BLEND OF CUTTING-EDGE TECHNOLOGY AND CLEAN LINES. THE LIGHT SOURCE CAN BE CONCENTRATED THROUGH THE UNION OF THE TWO LENSES THAT ALLOW TO DIRECT THE LIGHT UPWARDS AND DOWNWARDS AND ONCE DIVIDED CAN CREATE POINTS OF LIGHT IN TWO DIFFERENT POSITIONS AND ENSURES THE EFFICIENCY OF A BRIGHT LIGHT AND GLARE.

DESIGN DECISO E SOFISTICATO PER UNA APPLIQUE ALTAMENTE VERSATILE E FUNZIONALE. TRASPORTA LO STILE ITALIANO CONTEMPORANEO NEL MONDO DELL' ILLUMINAZIONE TECNOLOGICA DI QUALITÀ.

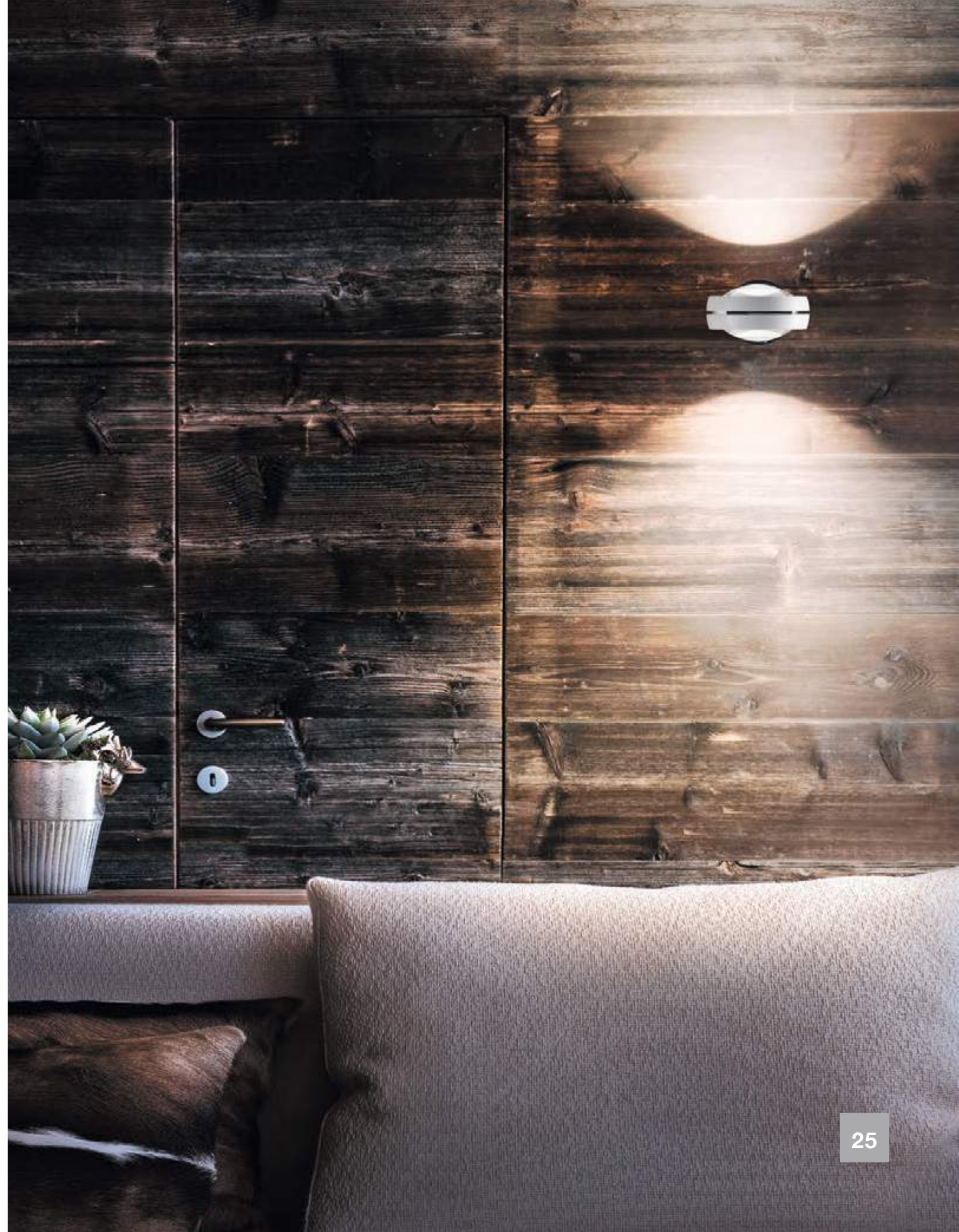





NAUTILUS
STUDIO
ITALIA
DESIGN



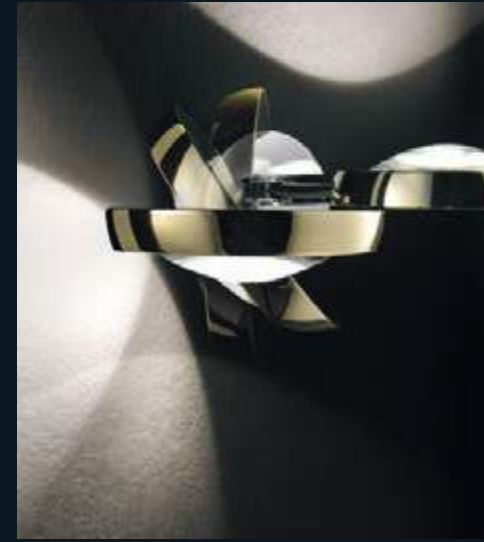



NAUTILUS
STUDIO
ITALIA
DESIGN

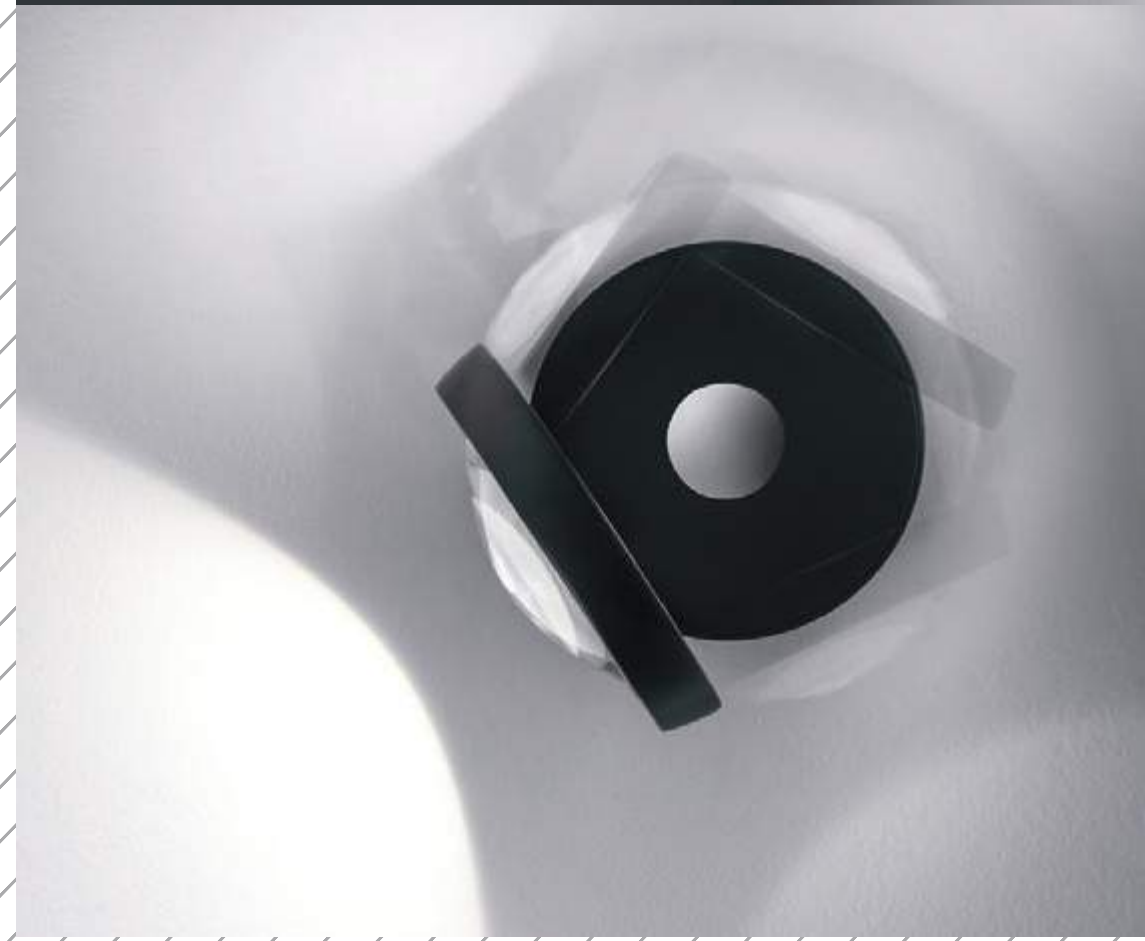













NAUTILUS

MODELLO | MODEL LAMPADINA | LAMP MONTATURA | FRAME DIFFUSORE | DIFFUSER CODICE | CODE

Nautilus Wall | Parete

	<p>LED COB</p> <p>2700K 2 x 15W 2400 lm 220-240V CRI 90 MacAdam 3-Step</p>	<p>LED included</p>	<p>● Bianco Opaco 9010 Matte White 9010</p> <p>● Nero Opaco Matte Black</p> <p>● Cromo Chrome</p> <p>● Oro Gold</p> <p>● Oro Rosa Rose Gold</p>	<p>165001</p> <p>165002</p> <p>165003</p> <p>165004</p> <p>165005</p>
	<p>OR</p> <p>LED COB</p> <p>3000K 2 x 15W 2600 lm 220-240V CRI 90 MacAdam 3-Step</p>		<p>● Cromo Chrome</p>	<p>● Bianco Opaco 9010 Matte White 9010</p> <p>● Nero Opaco Matte Black</p> <p>● Cromo Chrome</p> <p>● Oro Gold</p> <p>● Oro Rosa Rose Gold</p>
<p>max cm 19 7.48" min cm 16 6.3"</p> <p>90°</p> <p>Ø cm 13 5.11"</p> <p>max cm 28.5 11.22"</p>				
<p>CE, Energy saving, DIM TRIAC, IP 40</p>		<p>Peso netto: 1.15 Kg Net Weight:</p>	<p>Confezione Packaging</p>	<p>Peso Lordo: 1.25 Kg Gross Weight:</p> <p>n. Coll: 1 n. Pack:</p> <p>Volume m³: 0.008 Volume m³:</p>

Nautilus Ceiling | Soffitto

	<p>LED COB</p> <p>2700K 15W 1200 lm 220-240V CRI 90 MacAdam 3-Step</p>	<p>LED included</p>	<p>● Bianco Opaco 9010 Matte White 9010</p> <p>● Nero Opaco Matte Black</p> <p>● Cromo Chrome</p>	<p>165011</p> <p>165012</p> <p>165013</p>
	<p>OR</p> <p>LED COB</p> <p>3000K 15W 1300 lm 220-240V CRI 90 MacAdam 3-Step</p>		<p>NO NONE</p>	<p>● Bianco Opaco 9010 Matte White 9010</p> <p>● Nero Opaco Matte Black</p> <p>● Cromo Chrome</p>
<p>Ø cm 13.4 5.27"</p> <p>340°</p> <p>cm 5.8 2.28"</p> <p>cm 15.5 6.1"</p> <p>90°</p>				
<p>CE, Energy saving, DIM TRIAC, IP 40</p>		<p>Peso netto: 1.10 Kg Net Weight:</p>	<p>Confezione Packaging</p>	<p>Peso Lordo: 1.20 Kg Gross Weight:</p> <p>n. Coll: 1 n. Pack:</p> <p>Volume m³: 0.008 Volume m³:</p>

Note | Notes: LED con alimentazione diretta a tensione di rete (non necessita di driver LED). Dimmerabile con varialuce a taglio di fase.
LED with direct power supply to the AC line voltage (LED driver not required). Dimmable with phase cut dimming.

NAUTILUS composition

Nautilus example of composition

<p>[Ex: 1] Linear Composition Composizione Lineare</p>	
	<p>1 x 165017 1 x 165029 1 x 165030 1 x 165029 1 x 165023</p>
	<p>1 x 165021 1 x 165029 1 x 165030 1 x 165029 1 x 165032 1 x 165029 1 x 165027</p>
<p>[Ex: 2] Angular Composition Composizione ad Angolo</p>	
	<p>1 x 165021 1 x 165029 1 x 165030 1 x 165029 1 x 165032 1 x 165029 1 x 165027</p>
<p>CE, Energy saving, DIM TRIAC, IP 40</p>	

Note | Notes:

NAUTILUS system

MODELLO | MODEL LAMPADINA | LAMP MONTATURA | FRAME DIFFUSORE | DIFFUSER CODICE | CODE

Nautilus Single & Starting Module Pendant | Sospensione

	<p>2700K 4 x 15W 4800 lm 220-240V CRI 90 MacAdam 3-Step</p> <p>LED COB</p>	<p>OR</p> <p> Cromo Chrome</p>	<p> Bianco Opaco 9010 Matte White 9010</p> <p>165017</p>	<p>3000K 4 x 15W 5200 lm 220-240V CRI 90 MacAdam 3-Step</p> <p>LED COB</p>	<p> Nero Opaco Matte Black</p> <p>165018</p>	<p> Cromo Chrome</p> <p>165019</p>	<p> Bianco Opaco 9010 Matte White 9010</p> <p>165020</p>	<p> Nero Opaco Matte Black</p> <p>165021</p>	<p> Cromo Chrome</p> <p>165022</p>
	<p>LED included</p>		<p>Metallo Metal</p>		<p>Metallo Metal</p>				
<p>CE Peso netto: 4.1 Kg Confezione Packaging Peso Lordo: --- Kg n. Colli: 1 Volume m³: --- Net Weight: Gross Weight: n. Pack: Volume m³: ---</p>									

Nautilus Additional Module Pendant | Sospensione

	<p>2700K 4 x 15W 4800 lm 220-240V CRI 90 MacAdam 3-Step</p> <p>LED COB</p>	<p>OR</p> <p> Cromo Chrome</p>	<p> Bianco Opaco 9010 Matte White 9010</p> <p>165023</p>	<p>3000K 4 x 15W 5200 lm 220-240V CRI 90 MacAdam 3-Step</p> <p>LED COB</p>	<p> Nero Opaco Matte Black</p> <p>165024</p>	<p> Cromo Chrome</p> <p>165025</p>	<p> Bianco Opaco 9010 Matte White 9010</p> <p>165026</p>	<p> Nero Opaco Matte Black</p> <p>165027</p>	<p> Cromo Chrome</p> <p>165028</p>
	<p>LED included</p>		<p>Metallo Metal</p>		<p>Metallo Metal</p>				
<p>CE Peso netto: 4 Kg Confezione Packaging Peso Lordo: --- Kg n. Colli: 1 Volume m³: --- Net Weight: Gross Weight: n. Pack: Volume m³: ---</p>									

Note | Notes: Ad ogni "Starting Module" possono essere aggiunti fino ad un massimo di 9 "Additional Module". Dimmerabile con varialuce a taglio di fase.
Up to 9 "Additional Modules" can be added to each "Starting Module". Dimmable with phase cut dimming.

NAUTILUS system

MODELLO | MODEL INFO | INFO COLORE | COLOR SISTEMA | SYSTEM CODICE | CODE

Nautilus Junction Accessory | Accessorio

	<p>Giunto di collegamento con cavo d'acciaio di sostegno</p> <p>Connecting joint with steel support cable</p>	<p> Cromo Chrome</p>	<p>Nautilus system</p>	<p>165029</p>
<p>CE Confezione Packaging Peso netto: 0.05 Kg Peso Lordo: --- Kg n. Colli: 1 Volume m³: --- Net Weight: Gross Weight: n. Pack: Volume m³: ---</p>				

Nautilus Short Extension Accessory | Accessorio

	<p>Prolunga corta</p> <p>Short addition</p>	<p> Cromo Chrome</p>	<p>Nautilus system</p>	<p>165030</p>
<p>CE Confezione Packaging Peso netto: 0.55 Kg Peso Lordo: --- Kg n. Colli: 1 Volume m³: --- Net Weight: Gross Weight: n. Pack: Volume m³: ---</p>				

Nautilus Long Extension Accessory | Accessorio

	<p>Prolunga lunga</p> <p>Long addition</p>	<p> Cromo Chrome</p>	<p>Nautilus system</p>	<p>165031</p>
<p>CE Confezione Packaging Peso netto: 1.1 Kg Peso Lordo: --- Kg n. Colli: 1 Volume m³: --- Net Weight: Gross Weight: n. Pack: Volume m³: ---</p>				

Nautilus 90° Turn Accessory | Accessorio

	<p>Angolare</p> <p>Angular</p>	<p> Cromo Chrome</p>	<p>Nautilus system</p>	<p>165032</p>
<p>CE Confezione Packaging Peso netto: 0.3 Kg Peso Lordo: --- Kg n. Colli: 1 Volume m³: --- Net Weight: Gross Weight: n. Pack: Volume m³: ---</p>				

Note | Notes:

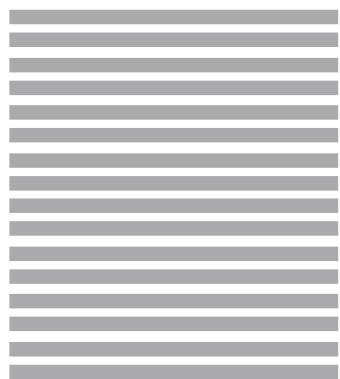
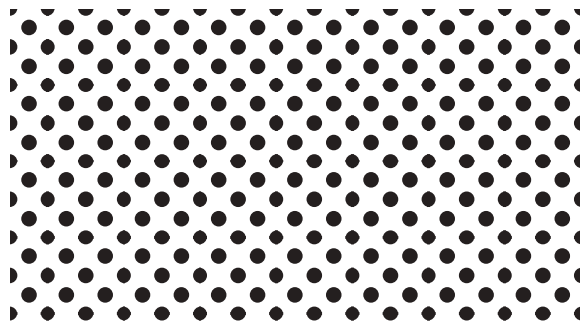

BUGIA

design: Andrea Tosetto 2016

THIS TRICKY CEILING FIXTURE LOOKS LIKE CHEATING AT FIRST SIGHT. ITS ELEGANT SHAPE AND BRIGHT FINISHES ENCHANT BY THINKING ONLY OF DIRECT LIGHTING. BUT ONCE LIT UP, THE TRUE ESSENCE AND SPIRIT OF BUGIA TURNS OUT REVEALING ITS HARMONY BETWEEN INDIRECT AND DIRECT LIGHT WITHOUT GLARE.

FINITURE ELEGANTI E BRILLANTI INCANTANO RIVELANDO UN EQUILIBRIO TRA LUCE INDIRECTA E DIRETTA, SENZA ABBAGLIARE. SOFISTICATA NELLE SUE FORME ROTONDE E PERFETTE CON UNO STILE SEMPLICE MA UNICO NEL SUO GENERE.





BUGIA
STUDIO
ITALIA
DESIGN



BUGIA
STUDIO
ITALIA
DESIGN









BUGIA

MODELLO | MODEL LAMPADINA | LAMP MONTATURA | FRAME DIFFUSORE | DIFFUSER CODICE | CODE

Bugia Single Ceiling | Plafoniera

<p>Ø cm 24 9.45"</p> <p>cm 3 1.18"</p> <p>cm 5</p> <p>Ø cm 16 6.30"</p>	<p>2700K 15W 1200 lm 220-240V CRI 90 MacAdam 3-Step</p> <p>LED COB</p>	<p>Bianco Opaco 9010 Matte White 9010</p>	<p>○ Bianco White</p> <p>● Oro Gold</p> <p>○ Cromo Chrome</p> <p>● Rame Lucido Glossy Copper</p>	<p>161025</p> <p>161026</p> <p>161027</p> <p>161028</p>		
	<p>OR</p> <p>3000K 15W 1300 lm 220-240V CRI 90 MacAdam 3-Step</p> <p>LED COB</p>		<p>○ Bianco White</p> <p>● Oro Gold</p> <p>○ Cromo Chrome</p> <p>● Rame Lucido Glossy Copper</p>	<p>161029</p> <p>161030</p> <p>161031</p> <p>161032</p>		
<p>CE Energy saving DIM TRIAC PG</p>		<p>Peso netto: 0.8 Kg Net Weight:</p>	<p>Confezione Packaging</p>	<p>Peso Lordo: 1.46 Kg Gross Weight:</p>	<p>n. Colli: 2 n. Pack:</p>	<p>Volume m³: 0.017 Volume m³:</p>

Bugia Double Ceiling | Plafoniera

<p>cm 32 12.6"</p> <p>Ø cm 19 7.48"</p> <p>cm 52.5 20.67"</p> <p>cm 3.5 1.37"</p> <p>cm 5.4 2.12"</p>	<p>2700K 2 x 15W 2400 lm 220-240V CRI 90 MacAdam 3-Step</p> <p>LED COB</p>	<p>Bianco Opaco 9010 Matte White 9010</p>	<p>○ Bianco White</p> <p>● Oro Gold</p> <p>○ Cromo Chrome</p> <p>● Rame Lucido Glossy Copper</p>	<p>161033</p> <p>161034</p> <p>161035</p> <p>161036</p>		
	<p>OR</p> <p>3000K 2 x 15W 2600 lm 220-240V CRI 90 MacAdam 3-Step</p> <p>LED COB</p>		<p>○ Bianco White</p> <p>● Oro Gold</p> <p>○ Cromo Chrome</p> <p>● Rame Lucido Glossy Copper</p>	<p>161037</p> <p>161038</p> <p>161039</p> <p>161040</p>		
<p>CE Energy saving DIM TRIAC PG</p>		<p>Peso netto: 2.05 Kg Net Weight:</p>	<p>Confezione Packaging</p>	<p>Peso Lordo: 4.91 Kg Gross Weight:</p>	<p>n. Colli: 2 n. Pack:</p>	<p>Volume m³: 0.062 Volume m³:</p>

Bugia Triple Ceiling | Plafoniera

<p>cm 51 20.08"</p> <p>cm 52.5 20.67"</p> <p>cm 3.5 1.37"</p> <p>cm 5.4 2.12"</p>	<p>2700K 3 x 15W 3600 lm 220-240V CRI 90 MacAdam 3-Step</p> <p>LED COB</p>	<p>Bianco Opaco 9010 Matte White 9010</p>	<p>○ Bianco White</p> <p>● Oro Gold</p> <p>○ Cromo Chrome</p> <p>● Rame Lucido Glossy Copper</p>	<p>161041</p> <p>161042</p> <p>161043</p> <p>161044</p>		
	<p>OR</p> <p>3000K 3 x 15W 3900 lm 220-240V CRI 90 MacAdam 3-Step</p> <p>LED COB</p>		<p>○ Bianco White</p> <p>● Oro Gold</p> <p>○ Cromo Chrome</p> <p>● Rame Lucido Glossy Copper</p>	<p>161045</p> <p>161046</p> <p>161047</p> <p>161048</p>		
<p>CE Energy saving DIM TRIAC PG</p>		<p>Peso netto: 2.8 Kg Net Weight:</p>	<p>Confezione Packaging</p>	<p>Peso Lordo: 5.66 Kg Gross Weight:</p>	<p>n. Colli: 2 n. Pack:</p>	<p>Volume m³: 0.062 Volume m³:</p>

Note | Notes: LED con alimentazione diretta a tensione di rete (non necessita di driver LED). Dimmerabile con varialuce a taglio di fase.
LED with direct power supply to the AC line voltage (LED driver not required). Dimmable with phase cut dimming.

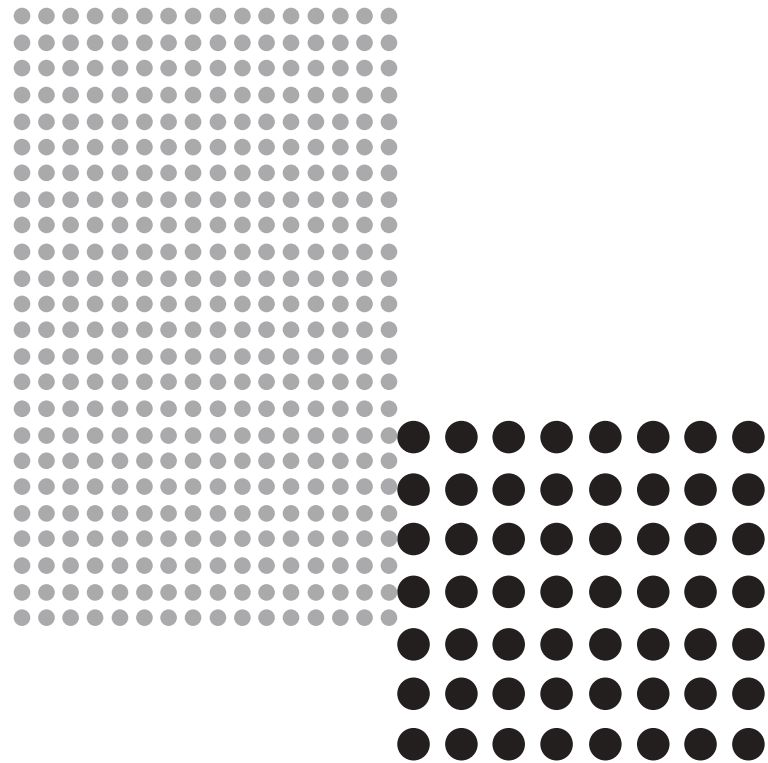

SPIDER

design: Andrea Tosetto 2016

THIS SPHERICAL SUSPENSION DESIGN IS REMINISCENT OF AN EYE WHICH CAN LOOK IN ANY CORNER OF THE ROOM. IT IS A PRECISE LIGHT PAIRED WITH AN ELEGANT DESIGN. ITS METALLIC SPHERICAL BODY HAS A ROUND AND CONVEX LENS LOCATED ON ONE SIDE. ITS ANGLE IS ADJUSTABLE AT WILL. THE SPHERE ROTATES BY 320 DEGREES AND TILTS BY 90 DEGREES ON THE SIDE, WHICH ENABLE TO DIRECT THE LIGHT DOWNWARDS AND LATERALLY. THE MODULARITY OF THE RANGE OF THE SPIDER ALLOWS YOU TO CREATE AN INFINITE VARIETY OF COMPOSITIONS.

SINGOLARMENTE PERLE PREZIOSE, MAESTOSE NEI CLUSTER. SI DIRAMANO PER SCENDERE IN INNUMEREVOLI GIOCHI DI LUCE ORIENTABILI, LÌ DOVE SERVE E COME PIACE. DIFFERENTI FINITURE PREZIOSE PER RENDERLA UNICA ED INIMITABILE.



SPIDER
STUDIO
ITALIA
DESIGN



SPIDER
STUDIO
ITALIA
DESIGN







THE
LIGHTING
MAKERS
2018



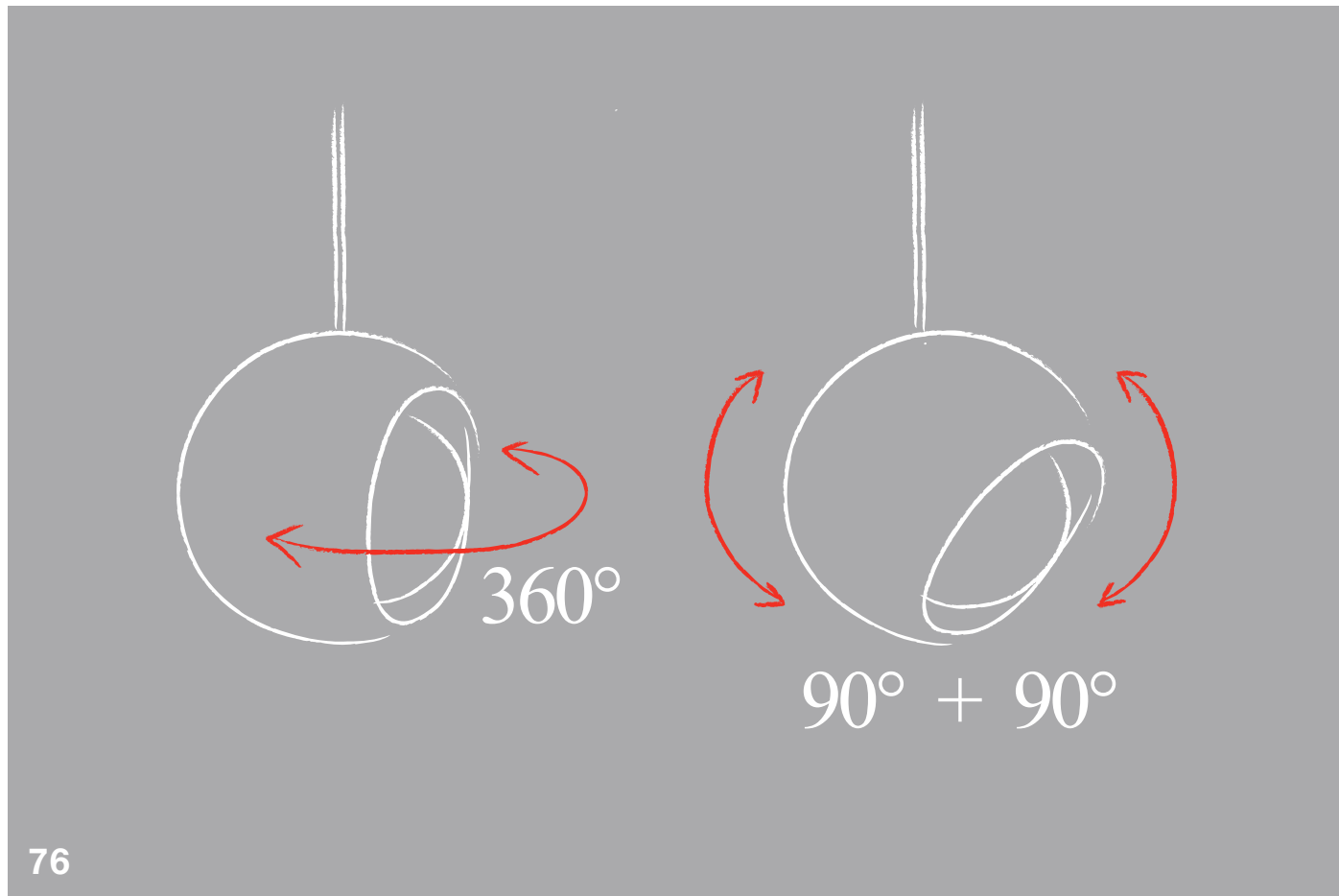

SPIDER composition

Spider example of composition

[Ex: 1] Single Radial Suspension | Sospensione Singola Decentrata

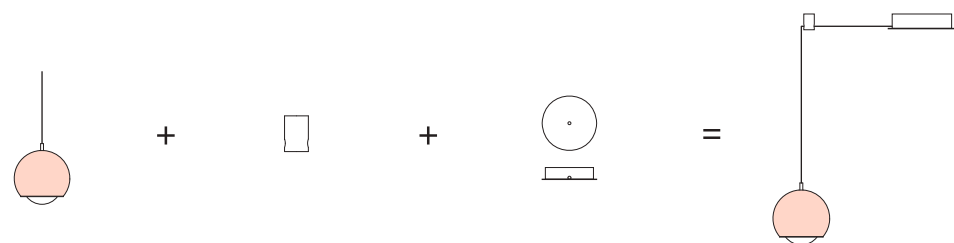

codice | code 1 x 160004 1 x 130009 1 x 154026

[Ex: 2] Cluster 3 Lights Composition | Composizione 3 Luci

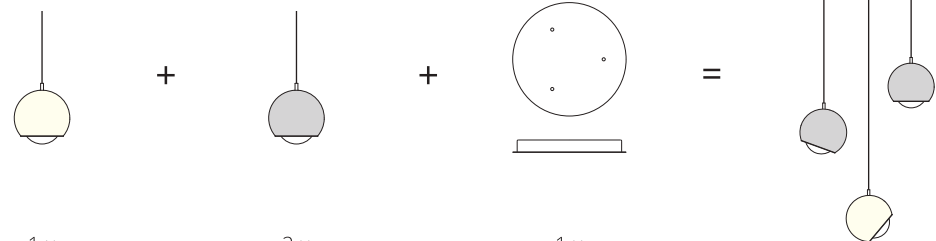

codice | code 1 x 160001 2 x 160002 1 x 154014

[Ex: 3] Radial 4 Lights Composition | Composizione 6 Luci Radiali

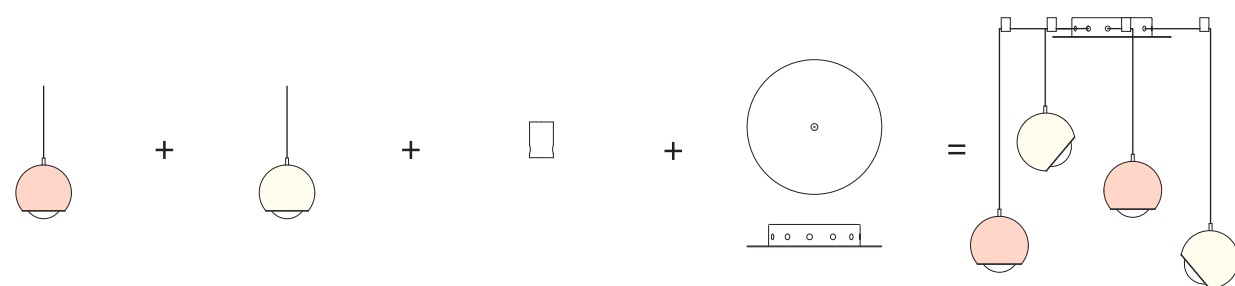

codice | code 2 x 160004 2 x 160001 4 x 130009 1 x 154027

[Ex: 4] Short Track with 4 Lights | Binario Lineare Multiplo Corto 4 Luci

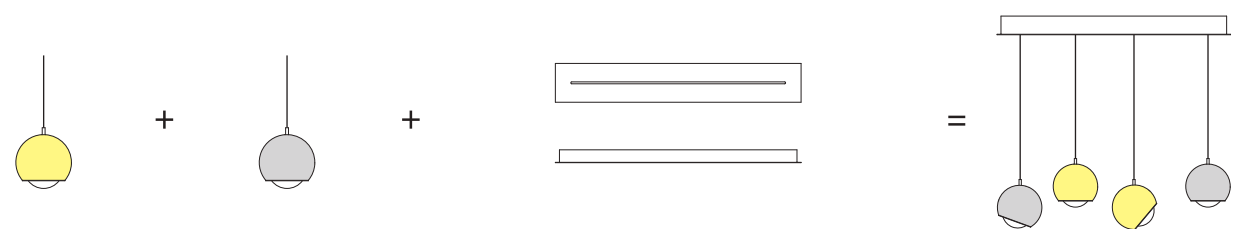

codice | code 2 x 160003 2 x 160002 1 x 154029

Note | Notes:

SPIDER

MODELLO | MODEL LAMPADINA | LAMP MONTATURA | FRAME DIFFUSORE | DIFFUSER CODICE | CODE

Spider Pendant | Sospensione

	<p>2700K 10W 850 lm LED COB 220-240V CRI 90 MacAdam 3-Step</p>	<p>OR</p> <p> Cromo Chrome</p>	<p> Bianco Opaco 9010 Matte White 9010</p> <p> Nero Opaco Matte Black</p> <p> Cromo Chrome</p> <p> Oro Gold</p> <p> Oro Rosa Rose Gold</p>	<p>160006</p> <p>160007</p> <p>160008</p> <p>160009</p> <p>160010</p>
	<p>3000K 10W 900 lm LED COB 220-240V CRI 90 MacAdam 3-Step</p>		<p> Bianco Opaco 9010 Matte White 9010</p> <p> Nero Opaco Matte Black</p> <p> Cromo Chrome</p> <p> Oro Gold</p> <p> Oro Rosa Rose Gold</p>	<p>160011</p> <p>160012</p> <p>160013</p> <p>160014</p> <p>160015</p>
<p>LED included</p>		<p>Metallo Metal</p>	<p>Metallo Metal</p>	<p>Peso netto: 0.8 Kg Confezione Packaging Peso Lordo: 1.1 Kg n. Colli: 2 Volume m³: 0.014 Net Weight: Gross Weight: n. Pack: Volume m³:</p>

Le sospensioni devono essere installate sui **rosoni** presenti alle pagine 360 - 365
The pendants must be installed with one of the **canopy** options listed on page 360 - 365
Les suspensions doivent être installées sur les **patères** présentées dans les pages 360 - 365
Die Hängeleuchten sollen auf die **Rosetten** auf Seiten 360 - 365 montiert werden
Las lámparas de suspensión se deben instalar en los **rósetones** a pagina 360 - 365

Note | Notes: LED con alimentazione diretta a tensione di rete (non necessita di driver LED). Dimmerabile con varialuce a taglio di fase.
LED with direct power supply to the AC line voltage (LED driver not required). Dimmable with phase cut dimming.

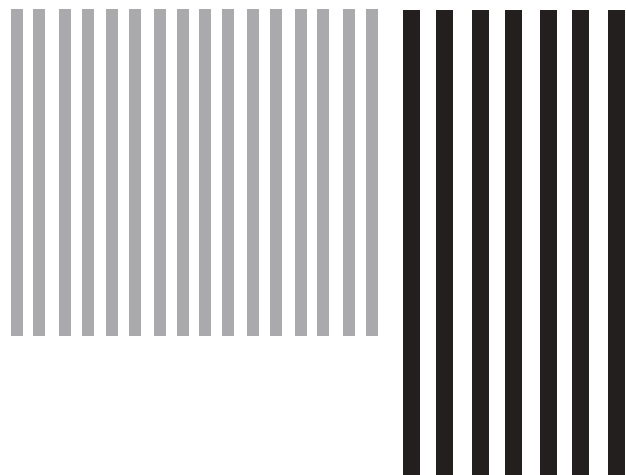

RAIN

design: Andrea Tosetto 2015

THE RAIN IS INSPIRED BY THE SPRING RAIN THAT FALLS SILENT AND LIGHT AND CAPTURES A MOMENT IN TIME TO BRING THE MAJESTY OF THE EVENT INSIDE YOUR SPACE IN ITS SIMPLICITY. THE CHROME DIFFUSER IS TAPERED OFF TO THE TOP INTO A SLENDER STEM AVAILABLE IN THE FOLLOWING FINISHES: MATTE WHITE, MATTE BLACK, COPPERY BRONZE, BRUSHED CHROME, GOLD AND ROSE GOLD. AT THE BASE OF EACH SHADE IS THE ROUNDED, GLASS DIFFUSER THAT CONCEALS THE LED LIGHT SOURCE. WHEN ILLUMINATED THIS DECORATIVE PENDANT LIGHT CASTS DIRECT DOWNWARD LIGHT. THE MODULARITY OF THE RAIN OFFERS A MULTITUDE OF STANDARD AS WELL AS CUSTOM COMPOSITIONS.

ISPIRATA ALLA PIOGGIA DI PRIMAVERA CHE CADE SILENZIOSA E LEGGERA, NE CATTURA UN ATTIMO PORTANDO LA MAESTOSITÀ DELL'EVENTO ALL'INTERNO DEGLI AMBIENTI NELLA SUA SEMPLICITÀ. LINEE MINIMALISTE IMPREZIOSITE DAI DETTAGLI COLORATI LA RENDONO UNICA E SEMPRE DIVERSA.



RAIN
STUDIO
ITALIA
DESIGN



THE
LIGHTING
MAKERS
2018





RAIN
STUDIO
ITALIA
DESIGN



RAIN composition

Rain example of composition

[Ex: 1] Double Opposed Suspensions | Sospensioni Contrapposte



[Ex: 2] Wall Light Composition | Composizione a Parete

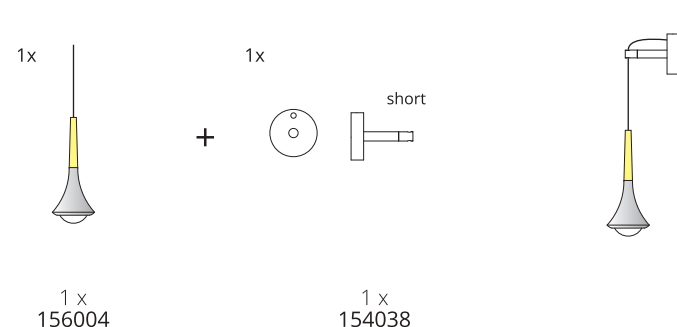

[Ex: 3] Cluster Rectangular 7 Lights Composition | Composizione 7 Rettangolare Luci

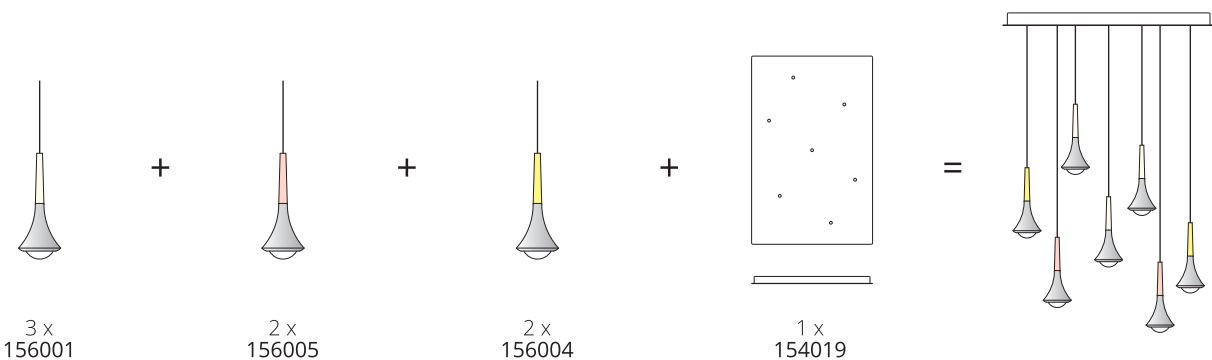

[Ex: 4] Short Track with 7 Lights | Binario Lineare Multiplo Corto 7 Luci

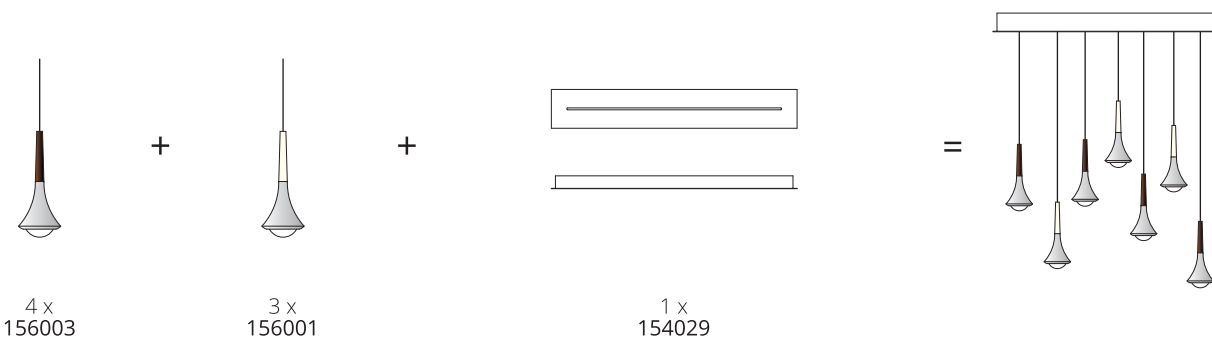

Note | Notes:

RAIN

MODELLO | MODEL LAMPADINA | LAMP MONTATURA | FRAME DECORO | DECOR CODICE | CODE

Rain Pendant | Sospensione

<p>Ø cm 8.5 3.34"</p> <p>max cm 400 157.48"</p> <p>cm 10 3.93"</p> <p>cm 21 8.26"</p> <p>Ø cm 8.5 3.34"</p>	<p>LED</p> <p>2700K 9W 900 lm 210-250V CRI 92 MacAdam 3-Step</p>	<p>OR</p> <p> Cromo Chrome</p>	<p> Bianco Opaco 9010 Matte White 9010</p> <p>156001</p> <p> Nero Opaco Matte Black</p> <p>156012</p> <p> Bronzo Ramato Coppery Bronze</p> <p>156003</p> <p> Cromo Chrome</p> <p>156002</p> <p>156004</p> <p> Oro Gold</p> <p>156005</p> <p> Oro Rosa Rose Gold</p>
	<p>LED</p> <p>3000K 9W 950 lm 210-250V CRI 92 MacAdam 3-Step</p>		<p> Bianco Opaco 9010 Matte White 9010</p> <p>156013</p> <p> Nero Opaco Matte Black</p> <p>156014</p> <p> Bronzo Ramato Coppery Bronze</p> <p>156015</p> <p> Cromo Chrome</p> <p>156016</p> <p> Oro Gold</p> <p>156018</p> <p> Oro Rosa Rose Gold</p> <p>156017</p>
<p>CE</p> <p>ip 40</p> <p>Energy saving</p> <p>DIM TRIAC</p> <p>PC</p>	<p>LED included</p> <p>Peso netto: 0.34 Kg Net Weight:</p> <p>Confezione Packaging</p>	<p>Metallo Metal</p> <p>Peso Lordo: 0.61 Kg Gross Weight:</p> <p>n. Colli: 2 n. Pack:</p> <p>Volume m³: 0.006 Volume m³:</p>	

Le sospensioni devono essere installate sui **rosoni** presenti alle pagine 360 - 365
 The pendants must be installed with one of the **canopy** options listed on page 360 - 365
 Les suspensions doivent être installées sur les **patères** présentées dans les pages 360 - 365
 Die Hängeleuchten sollen auf die **Rosetten** auf Seiten 360 - 365 montiert werden
 Las lámparas de suspensión se deben instalar en los **rósetones** a pagina 360 - 365

Note | Notes: LED con alimentazione diretta a tensione di rete (non necessita di driver LED). Dimmerabile con varialuce a taglio di fase.
 LED with direct power supply to the AC line voltage (LED driver not required). Dimmable with phase cut dimming.

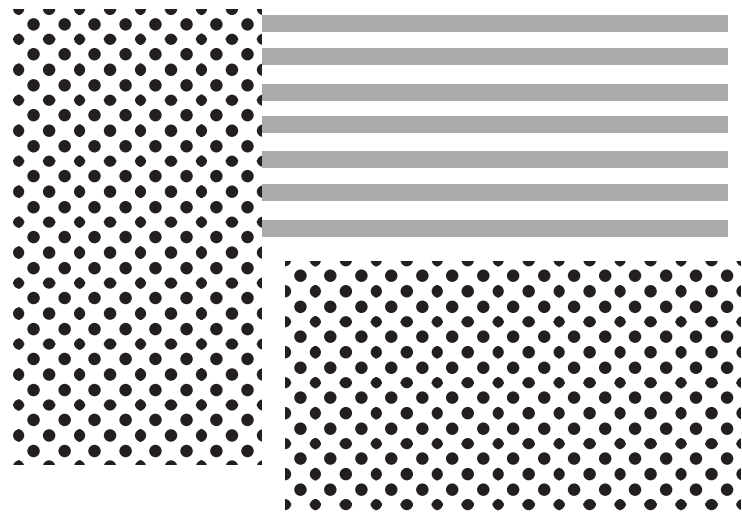

PINUP

design: Andrea Tosetto 2015

THE NIFTY LITTLE PIN-UP WALL AND CEILING LAMP CONSISTS OF TWO PARTS: THE BASE, WHICH IS FIXED TO THE WALL OR CEILING, AND A SMALL "COVER", WHICH HOUSES THE LIGHT SOURCE. THAT COVER IS MOVABLE AND CAN BE SET UP TO AN ANGLE OF 90 DEGREES. THUS, THE BRIGHTNESS CAN BE ADJUSTED CONTINUOUSLY. DEPENDING ON HOW THE PIN-UP IS APPLIED, THE LIGHT CAN RADIATE UPWARDS OR DOWNWARDS, OR BE KEPT FOLDED TO A MINIMUM. BY DESIGN, A CONE OF LIGHT IS GENERATED DEPENDING ON THE SETTING, WHICH CAN VARY FROM A NARROW CRESCENT, A LUSH CRESCENT TO AN OPEN CONE. THE LED LIGHT SOURCE IS SURROUNDED BY A GLASS LENS, WHICH CONTRIBUTES TO THE BEAUTIFUL LIGHTING EFFECTS.

ACCENTI DI LUCE RACCHIUSI IN UN DESIGN ORGANICO CHE UNA VOLTA DISCHIUSI E LASCIATI LIBERI DI ILLUMINARE CIÒ CHE CI INTERESSA STUPISCONO PER LA LORO SEMPLICITÀ E BELLEZZA GRAZIE A CALDO LED.







THE
LIGHTING
MAKERS
2018



PIN-UP
STUDIO
ITALIA
DESIGN

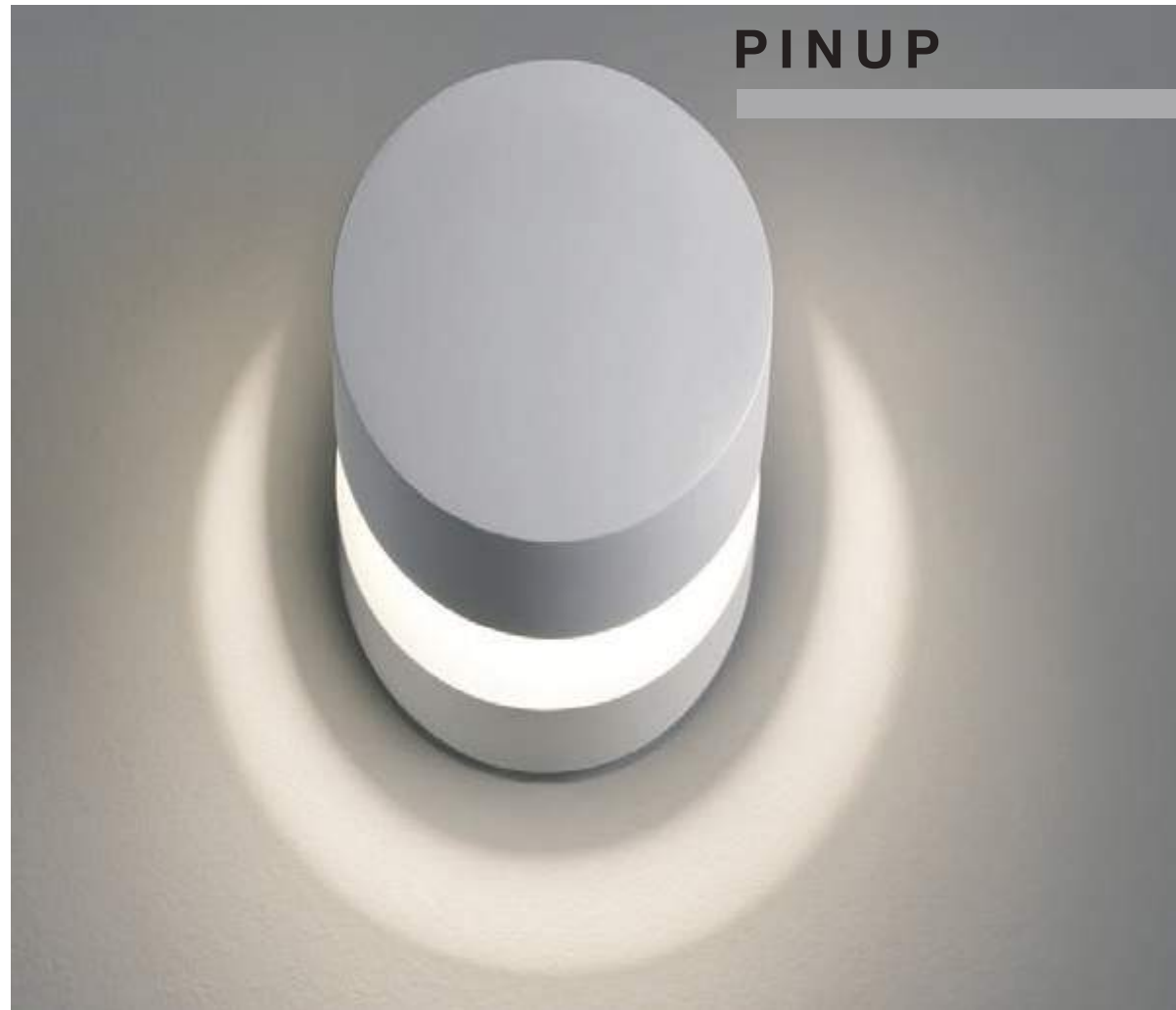

PIN-UP

MODELLO | MODEL LAMPADINA | LAMP MONTATURA | FRAME DIFFUSORE | DIFFUSER CODICE | CODE

Pin-Up Wall & Ceiling | Parete & Plafoniera

	<p>2700K 9W 900 lm LED 210-250V CRI 92 MacAdam 3-Step</p>	<p>● Bianco Opaco 9016 Matte White 9016</p> <p>● Bronzo Ramato Coppery Bronze</p> <p>● Cromo Chrome</p>	<p>NO NONE</p>	<p>155001</p> <p>155002</p> <p>155003</p>	
	<p>OR</p> <p>3000K 9W 950 lm LED 210-250V CRI 92 MacAdam 3-Step</p> <p>LED included</p>	<p>● Bianco Opaco 9016 Matte White 9016</p> <p>● Bronzo Ramato Coppery Bronze</p> <p>● Cromo Chrome</p> <p>Metallo Metal</p>		<p>155004</p> <p>155005</p> <p>155006</p>	
<p>CE</p> <p>ip 40</p> <p>Energy saving</p> <p>DIM TRIAC</p> <p>PC</p>	<p>Peso netto: Net Weight: 1.15 Kg</p>	<p>Confezione Packaging</p>	<p>Peso Lordo: Gross Weight: 1.4 Kg</p>	<p>n. Colli: n. Pack: 1</p>	<p>Volume m³: Volume m³: 0.008</p>

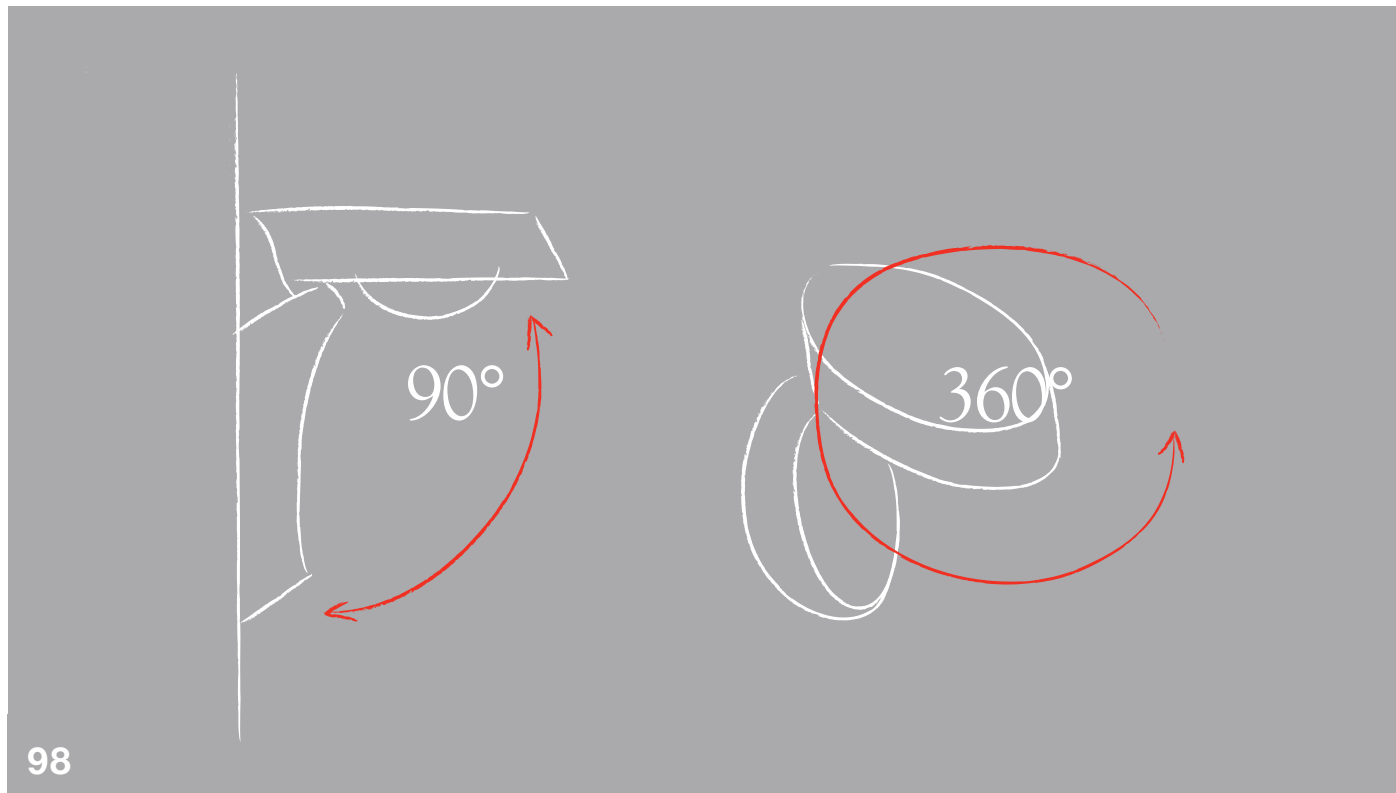

Note | Notes: LED con alimentazione diretta a tensione di rete (non necessita di driver LED). Dimmerabile con varialuce a taglio di fase.
LED with direct power supply to the AC line voltage (LED driver not required). Dimmable with phase cut dimming.

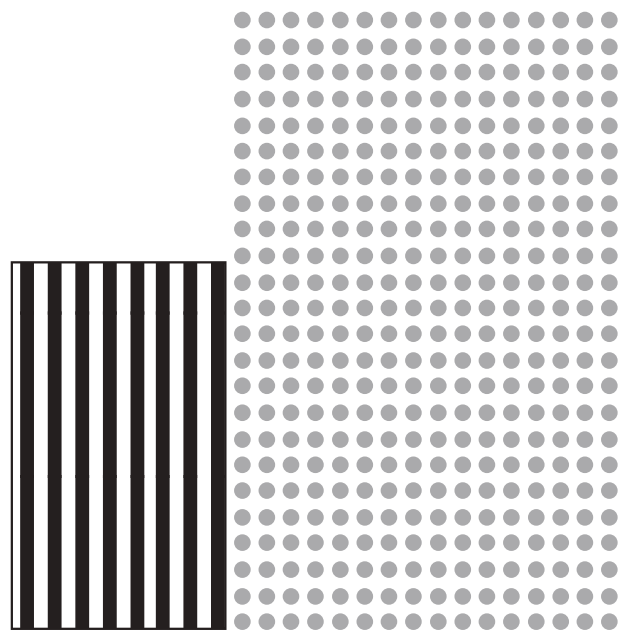

SHELF

design: Studio Italia Design 2015

WE HAVE PUT LIGHT ON A SHELF AND THROUGH ITS EYES, PURE CRYSTAL LENSES, WE CREATE FANTASTIC LIGHT EFFECTS ON YOUR WALLS.

SOPRA LA MENSOLA NOI CI ABBIAMO MESSO LA LUCE , FACENDO INTRAVEDERE I SUOI OCCHI, LENTI IN PURO CRISTALLO CHE CREERANNO FANTASTICI GIOCHI DI LUCE SULLE VOSTRE PARETI.



SHELF
STUDIO
ITALIA
DESIGN



SHELF



MODELLO | MODEL

LAMPADINA | LAMP

MONTATURA | FRAME

DIFFUSORE | DIFFUSER

CODICE | CODE

Shelf Single Wall | Parete

	<p>LED 2700K 17W 1700 lm 210-250V CRI 92 MacAdam 3-Step</p>	<p>○ Bianco Opaco 9016 Matte White 9016</p>	<p>NO NONE</p>	151005			
	<p>OR</p> <p>LED 3000K 17W 1800 lm 210-250V CRI 92 MacAdam 3-Step</p>			151003			
<p>CE ip40 Energy saving DIM TRIAC PG</p>		<p>Metallo Metal</p>	<p>Peso netto: 0.9 Kg Net Weight:</p>	<p>Confezione Packaging</p>	<p>Peso Lordo: 1.06 Kg Gross Weight:</p>	<p>n. Colli: 1 n. Pack:</p>	<p>Volume m³: 0.004 Volume m³:</p>

Shelf Double Wall | Parete

	<p>LED 2700K 2x17W 3400 lm 210-250V CRI 92 MacAdam 3-Step</p>	<p>○ Bianco Opaco 9016 Matte White 9016</p>	<p>NO NONE</p>	151004			
	<p>OR</p> <p>LED 3000K 2x17W 3600 lm 210-250V CRI 92 MacAdam 3-Step</p>			151002			
<p>CE ip40 Energy saving DIM TRIAC PG</p>		<p>Metallo Metal</p>	<p>Peso netto: 1.9 Kg Net Weight:</p>	<p>Confezione Packaging</p>	<p>Peso Lordo: 2.29 Kg Gross Weight:</p>	<p>n. Colli: 1 n. Pack:</p>	<p>Volume m³: 0.012 Volume m³:</p>

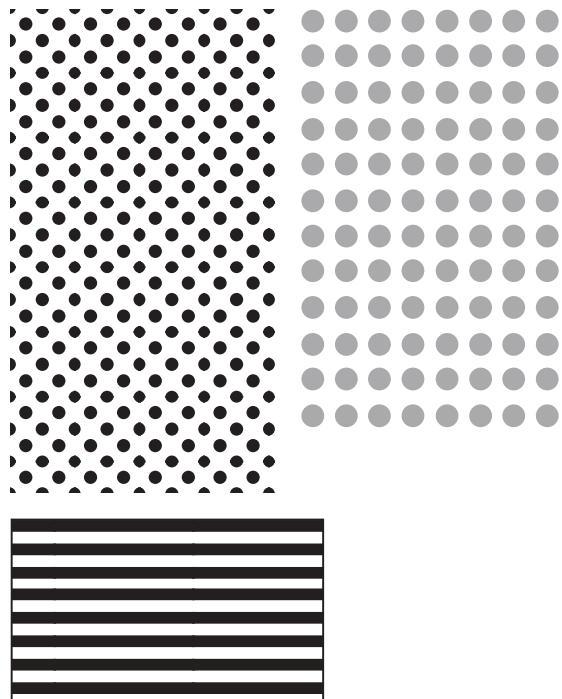

FROZEN

design: Studio Italia Design 2015

FLAT LIKE A SHEET OF PAPER WITH A MINIMALIST DESIGN THAT ALLOWS YOU TO SEE ITS EYES, LENSES MADE OF PURE CRYSTAL SIMILAR TO ICICLES WHICH WILL BRING ANY ENVIRONMENT TO LIFE THANKS TO THE EFFECTS THE LENSES CREATE.

PIATTA COME UN FOGLIO, DAL DESIGN MINIMALISTA LASCIA INTRAVEDERE I SUOI OCCHI, LENTI IN PURO CRISTALLO SIMILI A GHIACCIOLI CHE SAPRANNO DARE VITA, ATTRAVERSO EFFETTI LUMINOSI, A TUTTI GLI AMBIENTI.







FROZEN

MODELLO | MODEL LAMPADINA | LAMP MONTATURA | FRAME DIFFUSORE | DIFFUSER CODICE | CODE

Frozen Small Ceiling | Plafoniera

	<p>2700K 17W 1700 lm 210-250V CRI 92 MacAdam 3-Step</p> <p>LED</p>	<p>● Bianco Opaco 9016 Matte White 9016</p> <p>● Bronzo Ramato Coppery Bronze</p>	NO NONE	149019		
	<p>OR</p> <p>3000K 17W 1800 lm 210-250V CRI 92 MacAdam 3-Step</p> <p>LED</p>	<p>● Bianco Opaco 9016 Matte White 9016</p> <p>● Bronzo Ramato Coppery Bronze</p>		149003	149007	
<p>LED included</p>		<p>Metallo Metal</p>				
<p>CE </p>		<p>Peso netto: 1.77 Kg Net Weight:</p>	<p>Confezione Packaging</p>	<p>Peso Lordo: 2.23 Kg Gross Weight:</p>	<p>n. Colli: 1 n. Pack:</p>	<p>Volume m³: 0.015 Volume m³:</p>

Frozen Medium Ceiling | Plafoniera

	<p>2700K 2 x 17W 3400 lm 210-250V CRI 92 MacAdam 3-Step</p> <p>LED</p>	<p>● Bianco Opaco 9016 Matte White 9016</p> <p>● Bronzo Ramato Coppery Bronze</p>	NO NONE	149017		
	<p>OR</p> <p>3000K 2 x 17W 3600 lm 210-250V CRI 92 MacAdam 3-Step</p> <p>LED</p>	<p>● Bianco Opaco 9016 Matte White 9016</p> <p>● Bronzo Ramato Coppery Bronze</p>		149002	149006	
<p>LED included</p>		<p>Metallo Metal</p>				
<p>CE </p>		<p>Peso netto: 3.27 Kg Net Weight:</p>	<p>Confezione Packaging</p>	<p>Peso Lordo: 4.01 Kg Gross Weight:</p>	<p>n. Colli: 1 n. Pack:</p>	<p>Volume m³: 0.028 Volume m³:</p>

Frozen Large Ceiling | Plafoniera

	<p>2700K 4 x 17W 6800 lm 210-250V CRI 92 MacAdam 3-Step</p> <p>LED</p>	<p>● Bianco Opaco 9016 Matte White 9016</p> <p>● Bronzo Ramato Coppery Bronze</p>	NO NONE	149015		
	<p>OR</p> <p>3000K 4 x 17W 7200 lm 210-250V CRI 92 MacAdam 3-Step</p> <p>LED</p>	<p>● Bianco Opaco 9016 Matte White 9016</p> <p>● Bronzo Ramato Coppery Bronze</p>		149001	149005	
<p>LED included</p>		<p>Metallo Metal</p>				
<p>CE </p>		<p>Peso netto: 7.78 Kg Net Weight:</p>	<p>Confezione Packaging</p>	<p>Peso Lordo: 10.04 Kg Gross Weight:</p>	<p>n. Colli: 1 n. Pack:</p>	<p>Volume m³: 0.115 Volume m³:</p>

Note | Notes: LED con alimentazione diretta a tensione di rete (non necessita di driver LED). Dimmerabile con varialuce a taglio di fase.
LED with direct power supply to the AC line voltage (LED driver not required). Dimmable with phase cut dimming.

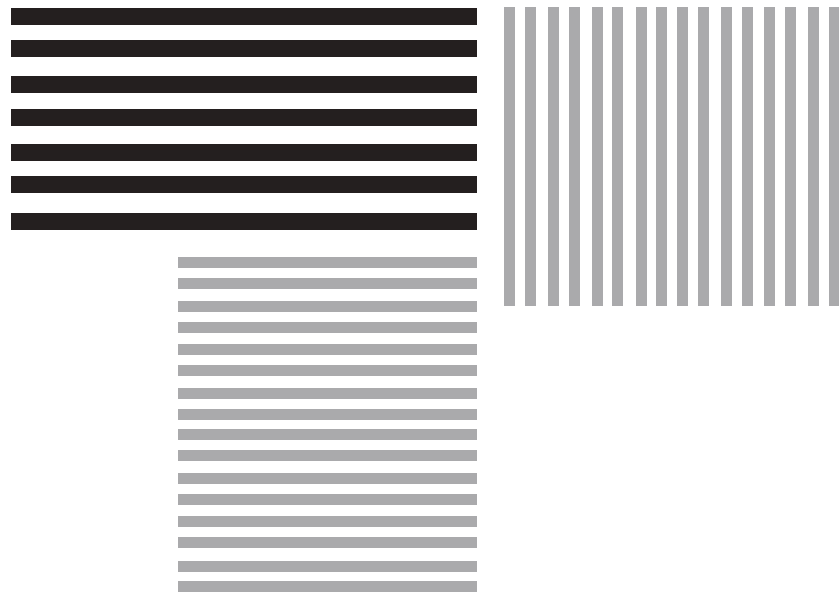

A-TUBE NANO

design: Studio Italia Design 2016

A-TUBE NANO, IT'S LIKE A PRECIOUS PIN WITH A TRANSPARENT GLASS DETAIL AT THE END THAT SHINES LIKE MORNING DEW IN THE SUNSHINE ON A SPRING MORNING. WHEN USED INDIVIDUALLY IS PERFECT FOR MINIMALISTIC SPACES HOWEVER THANKS TO ALL THE OPTIONAL CANOPIES BEING OFFERED ONE CAN CREATE BEAUTIFUL CLUSTERS VARYING HARMONICALLY IN VARIOUS HEIGHTS.

LINEE SOTTILI CHE VENGONO IMPREZIOSITE DAL DETTAGLIO CRISTALLO TRASPARENTE CHE QUANDO ILLUMINATO RISALTA COME LA RUGIADA IN PRIMAVERA. GRAZIE ALLA SUA MODULARITÀ CREA BELLISSIME COMPOSIZIONI CLUSTER.





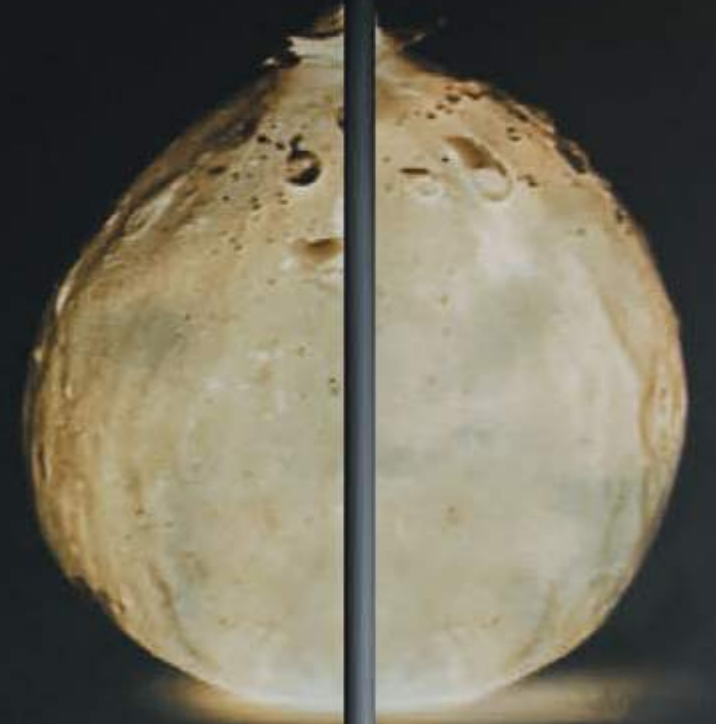
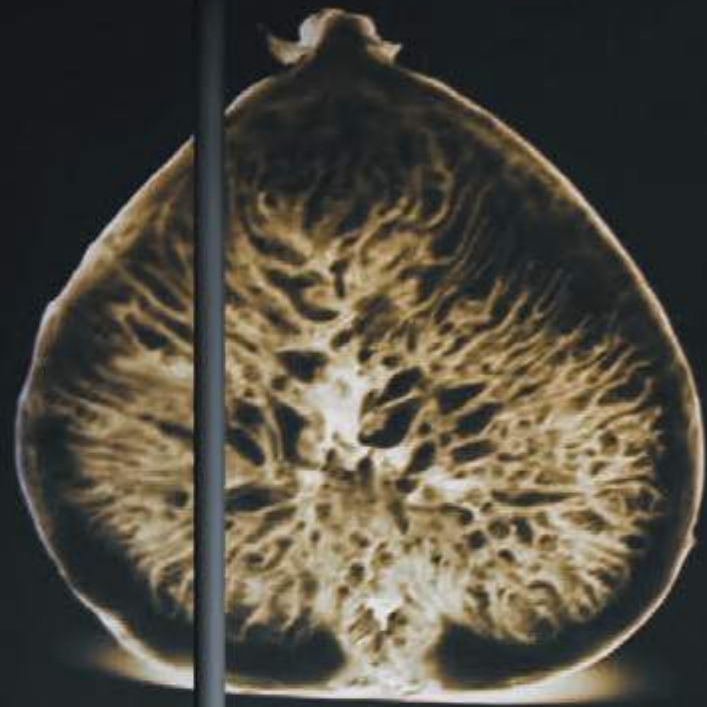

A-TUBE
NANO
STUDIO
ITALIA
DESIGN





A-TUBE
NANO
STUDIO
ITALIA
DESIGN



A-TUBE NANO

composition

A-Tube Nano example of composition

[Ex: 1] Single Mini Suspensions | Sospensione Singola Mini

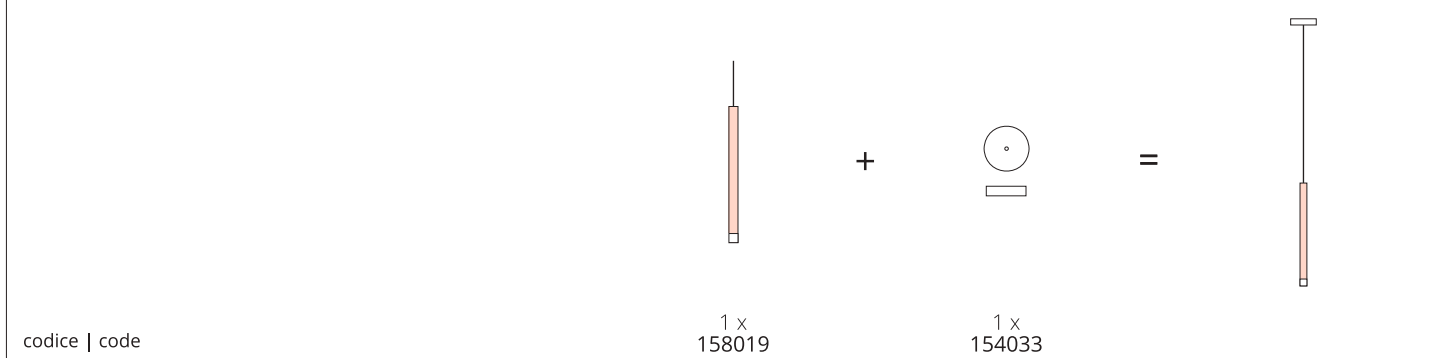

[Ex: 2] Cluster 3 Lights Composition | Composizione 3 Luci

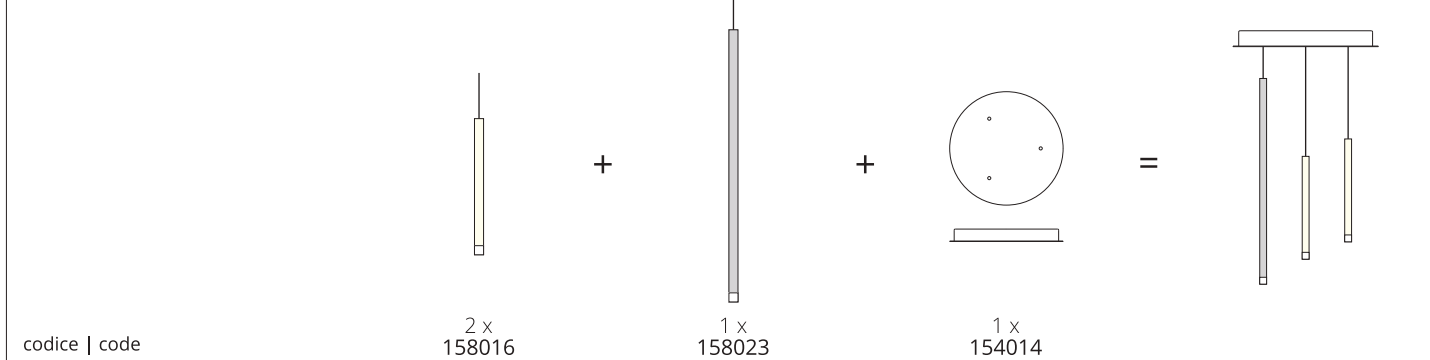

[Ex: 3] Recessed Lights Composition | Composizione Lampade Incassate

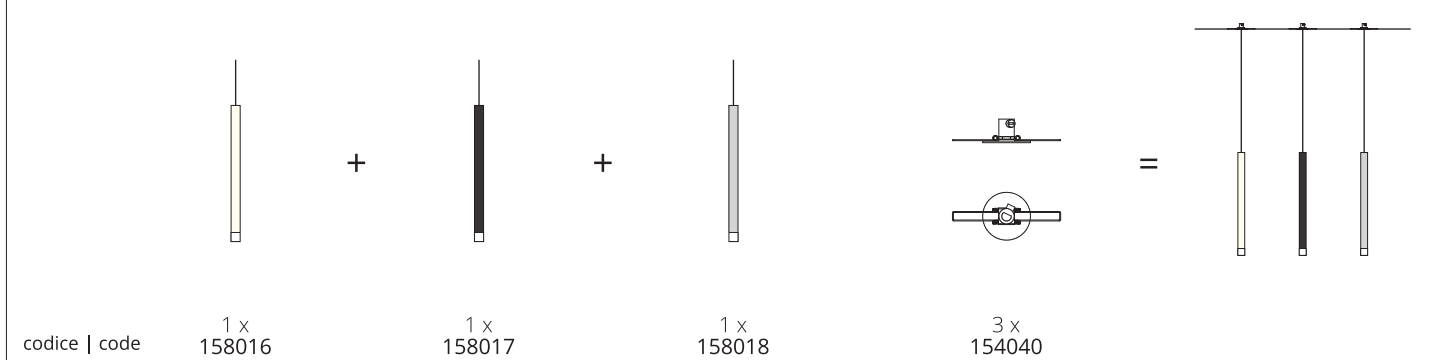

[Ex: 4] Short Track with 7 Lights | Binario Lineare Multiplo Corto 7 Luci

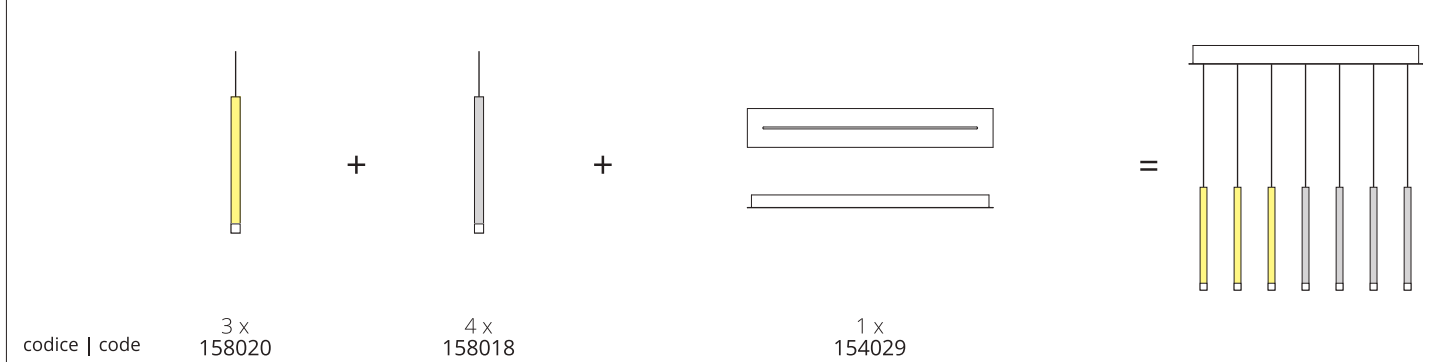

Note | Notes: Le sospensioni A-Tube Nano non sono utilizzabili sul Radial system
The A-Tube Nano pendants are not compatible with the Radial system

A-TUBE NANO

MODELLO | MODEL LAMPADINA | LAMP MONTATURA | FRAME DIFFUSORE | DIFFUSER CODICE | CODE

A-Tube Nano Small Pendant | Sospensione

	LED 2700K 3W 400 lm 350mA CRI 90 MacAdam 3-Step LED and DRIVER included	Bianco Opaco 9010 Matte White 9010	Trasparente Clear	158016	
		Nero Opaco Matte Black		158017	
		Cromo Chrome		158018	
		Oro Rosa Rose Gold		158019	
		Oro Gold		158020	
Peso netto: 0.25 Kg Net Weight:		Confezione Packaging	Peso Lordo: 0.35 Kg Gross Weight:	n. Colli: 2 n. Pack:	Volume m³: 0.003 Volume m³:

A-Tube Nano Medium Pendant | Sospensione

	LED 2700K 3W 400 lm 350mA CRI 90 MacAdam 3-Step LED and DRIVER included	Bianco Opaco 9010 Matte White 9010	Trasparente Clear	158021	
		Nero Opaco Matte Black		158022	
		Cromo Chrome		158023	
		Oro Rosa Rose Gold		158024	
		Oro Gold		158025	
Peso netto: 0.3 Kg Net Weight:		Confezione Packaging	Peso Lordo: 0.4 Kg Gross Weight:	n. Colli: 2 n. Pack:	Volume m³: 0.003 Volume m³:

A-Tube Nano Large Pendant | Sospensione

	LED 2700K 3W 400 lm 350mA CRI 90 MacAdam 3-Step LED and DRIVER included	Bianco Opaco 9010 Matte White 9010	Trasparente Clear	158026	
		Nero Opaco Matte Black		158027	
		Cromo Chrome		158028	
		Oro Rosa Rose Gold		158029	
		Oro Gold		158030	
Peso netto: 0.4 Kg Net Weight:		Confezione Packaging	Peso Lordo: 0.5 Kg Gross Weight:	n. Colli: 2 n. Pack:	Volume m³: 0.004 Volume m³:

Le sospensioni devono essere installate sui **rosoni** presenti alle pagine 360 - 364 - **Non utilizzabile sul Radial system**
 The pendants must be installed with one of the **canopy** options listed on page 360 - 364 - **Not compatible with the Radial system**
 Les suspensions doivent être installées sur les **patères** présentées dans les pages 360 - 364 - **Ne pas utiliser avec le système Radial**
 Die Hängeleuchten sollen auf die **Rosetten** auf Seiten 360 - 364 montiert werden - **Nicht verwendbar mit radialem System**
 Las lámparas de suspensión se deben instalar en los **rósetones** a pagina 360 - 364 - **No se puede utilizar con sistema Radial**

Note | Notes: Modello 2018 disponibile da Marzo 2018
Model 2018 available from March 2018

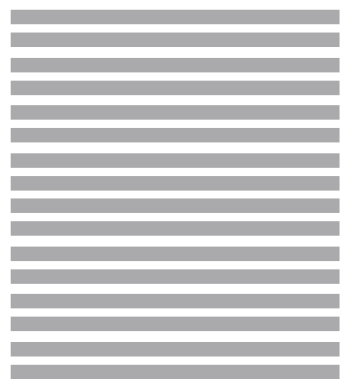
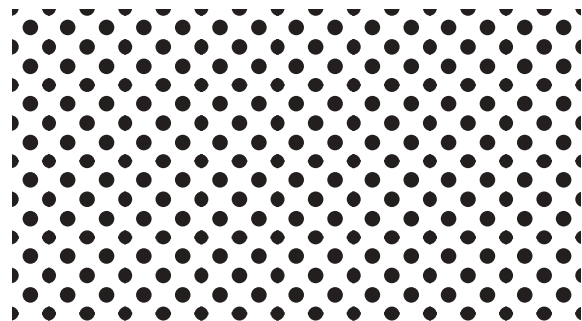

A-TUBE NANO DUO

design: Studio Italia Design 2017

THE A-TUBE DUO IS AN OFFSHOOT OF THE A-TUBE NANO BUT WITH AN LED LIGHT SOURCE ON BOTH ENDS OF THE SLIM METAL DIFFUSER. THESE PRECIOUS PINS ARE SUSPENDED TO THE CANOPY WITH A THIN CABLE GIVING A MAGICAL EFFECT TO THESE CRYSTAL LIGHTS TO BE FLOATING IN TIME AND SPACE. USED INDIVIDUALLY FOR A CLEAN AND MINIMALIST APPLICATION OR ONE CAN CREATE ENDLESS COMPOSITIONS TO REACH THE MAXIMUM SPECTACULAR EFFECT.

SPILLI IMPREZIOSITI DA PUNTE DI CRISTALLO SOSPESI NEL TEMPO E NELLO SPAZIO. L'ELEGANZA LI CONTRADDISTINGUE SINGOLARMENTE, MA SE UTILIZZATE IN COMPOSIZIONI LUMINOSE DI FORTE IMPATTO RAGGIUNGONO IL MASSIMO EFFETTO SCENOGRAFICO



**A-TUBE
NANO DUO
STUDIO
ITALIA
DESIGN**









A-TUBE NANO DUO

composition

MODELLO | MODEL LAMPADINA | LAMP MONTATURA | FRAME DIFFUSORE | DIFFUSER CODICE | CODE

A-Tube Nano Duo example of composition

[Ex: 1] Single Mini Suspensions | Sospensione Singola Mini

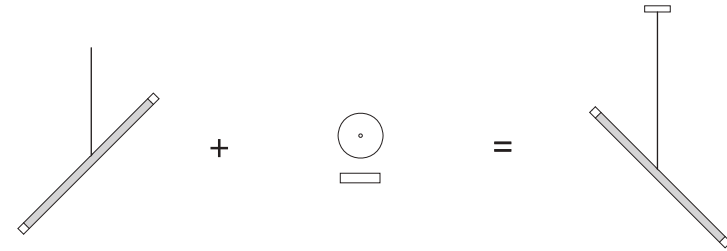

codice | code 1 x 158033 1 x 154033

[Ex: 2] Cluster 3 Lights Composition | Composizione 3 Luci

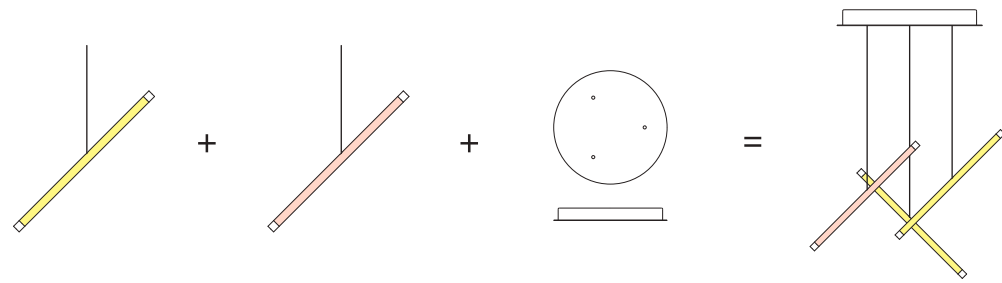

codice | code 2 x 158035 1 x 158034 1 x 154014

[Ex: 3] Cluster Rectangular 7 Lights Composition | Composizione 7 Rettangolare Luci

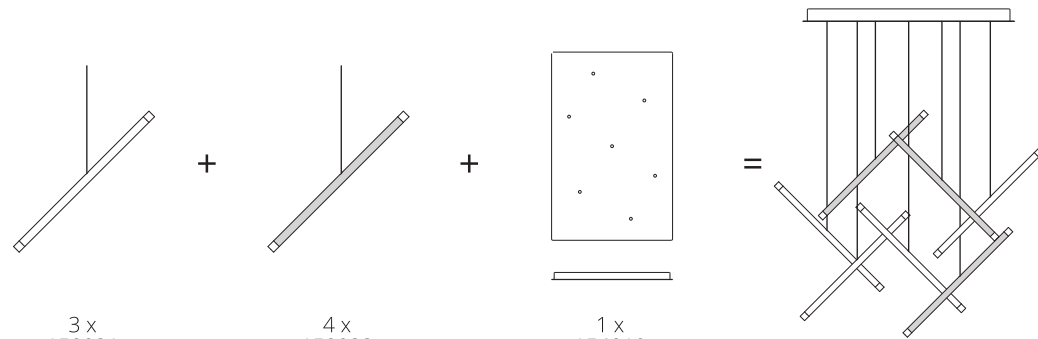

codice | code 3 x 158031 4 x 158033 1 x 154019

[Ex: 4] Short Track with 4 Lights | Binario Lineare Multiplo Corto 4 Luci

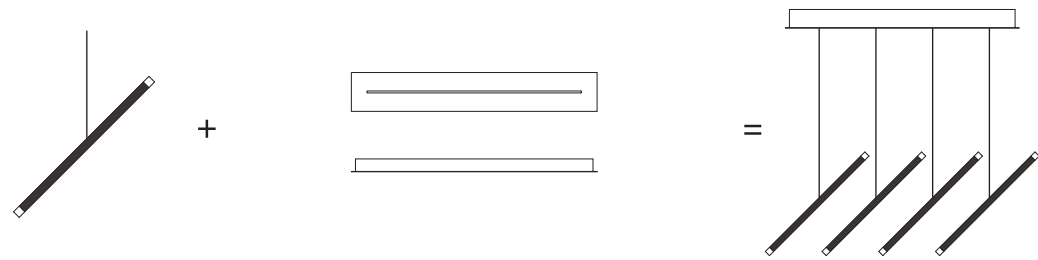

codice | code 4 x 158032 1 x 154029

Note | Notes: Le sospensioni A-Tube Nano Duo non sono utilizzabili sul Radial system
The A-Tube Nano Duo pendants are not compatible with the Radial system

A-TUBE NANO DUO

MODELLO | MODEL LAMPADINA | LAMP MONTATURA | FRAME DIFFUSORE | DIFFUSER CODICE | CODE

A-Tube Nano Duo Pendant | Sospensione

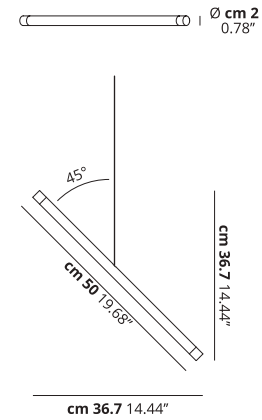

LED
2700K
2 x 1W | 300 lm
350mA
CRI 90
MacAdam 3-Step

- Bianco Opaco 9010
Matte White 9010
- Nero Opaco
Matte Black
- Cromo
Chrome
- Oro Rosa
Rose Gold
- Oro
Gold

Trasparente
Clear

158031

158032

158033

158034

158035

LED and DRIVER included

Metallo
Metal

Polycarbonato
Polycarbonate



Peso netto: 0.21 Kg
Net Weight:

Confezione Packaging

Peso Lordo: 0.31 Kg
Gross Weight:

n. Colli: 1
n. Pack:

Volume m³: 0.002
Volume m³:

Le sospensioni devono essere installate sui **rosoni** presenti alle pagine 360 - 364 - Non utilizzabile sul Radial system
The pendants must be installed with one of the **canopy** options listed on page 360 - 364 - Not compatible with the Radial system
Les suspensions doivent être installées sur les **patères** présentées dans les pages 360 - 364 - Ne pas utiliser avec le système Radial
Die Hängeleuchten sollen auf die **Rosetten** auf Seiten 360 - 364 montiert werden - Nicht verwendbar mit radialem System
Las lámparas de suspensión se deben instalar en los **rósetones** a pagina 360 - 364 - No se puede utilizar con sistema Radial

Note | Notes:



A-TUBE

design: Studio Italia Design 2013

THE A-TUBE FAMILY FEATURES SEVERAL MINIMALISTIC CEILING AND PENDANT LIGHT FIXTURES MADE OF METAL SHAPED LIKE CYLINDERS AND AVAILABLE IN VARIOUS LENGTHS AND FINISHES. THIS SLIM, CYLINDRICAL PENDANT AND CEILING LIGHT IS PERFECT FOR USE BY ITSELF OR WHEN ARRANGED IN CLUSTERS OR ROWS. THIS MODERN FIXTURE PROVIDES DIRECT ILLUMINATION.

UNA LUCE CHE PUNTA DIRETTA ALL'OBIETTIVO. UNA LINEA SEMPLICE CHE NON SMETTE DI RINNOVARSI. SEMPRE PIÙ MODERNA E ALLA MODA.

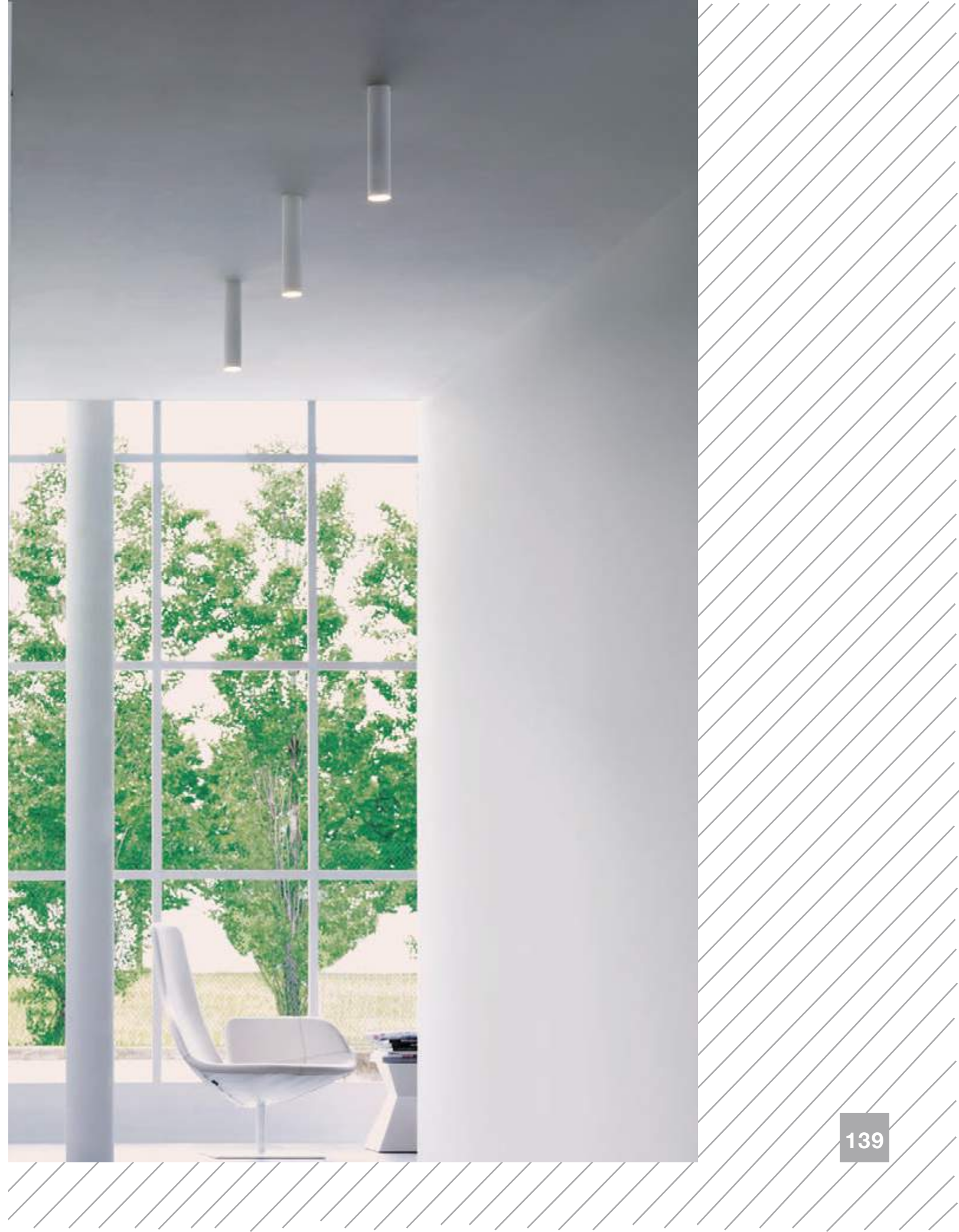

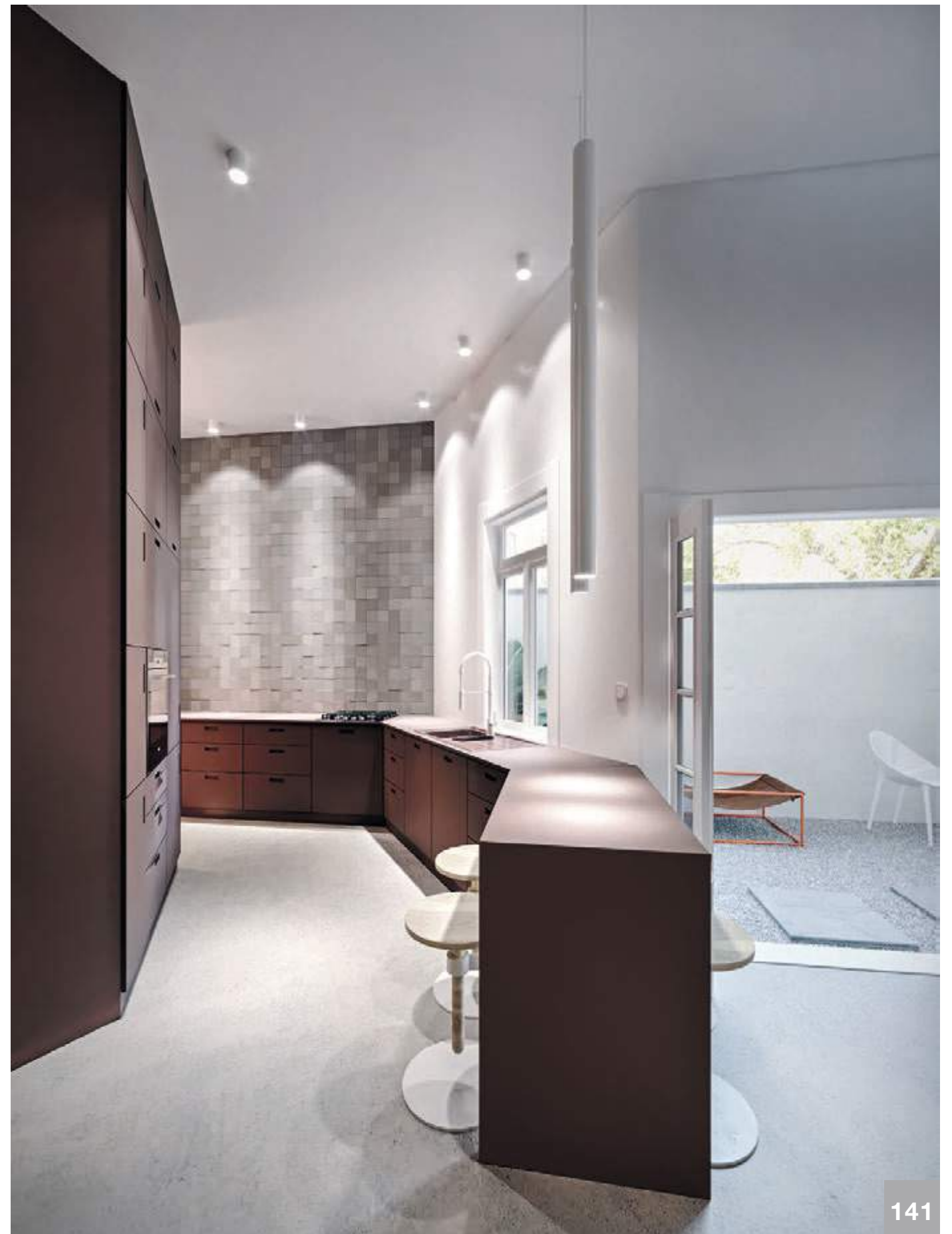

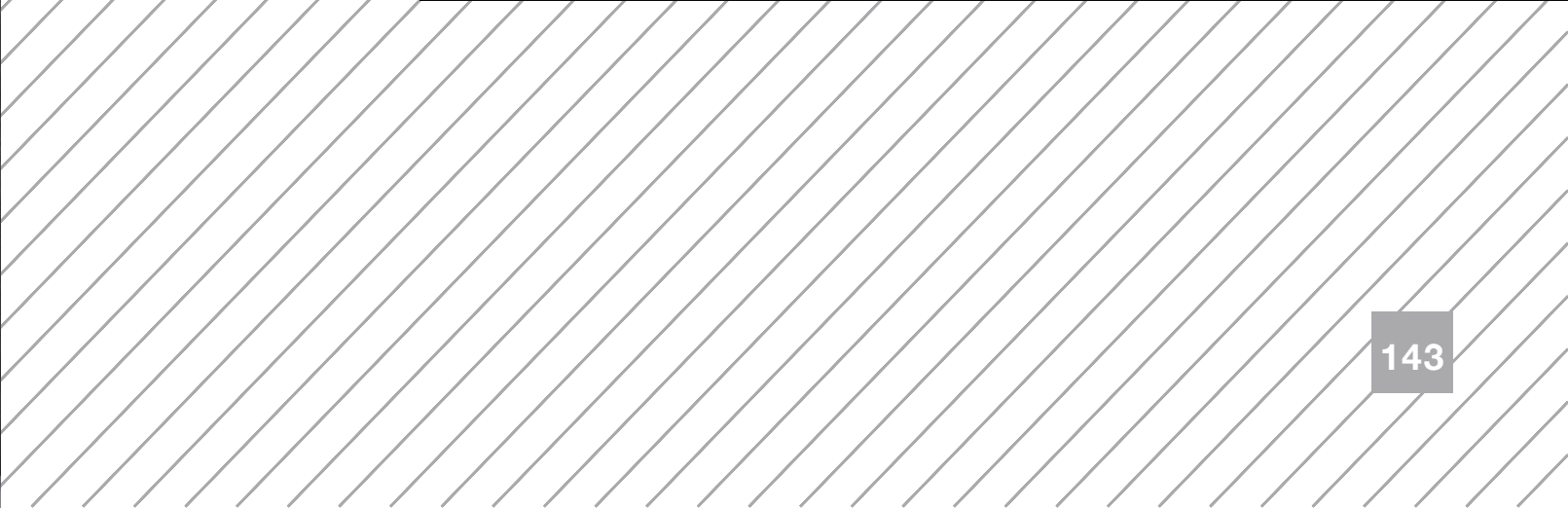
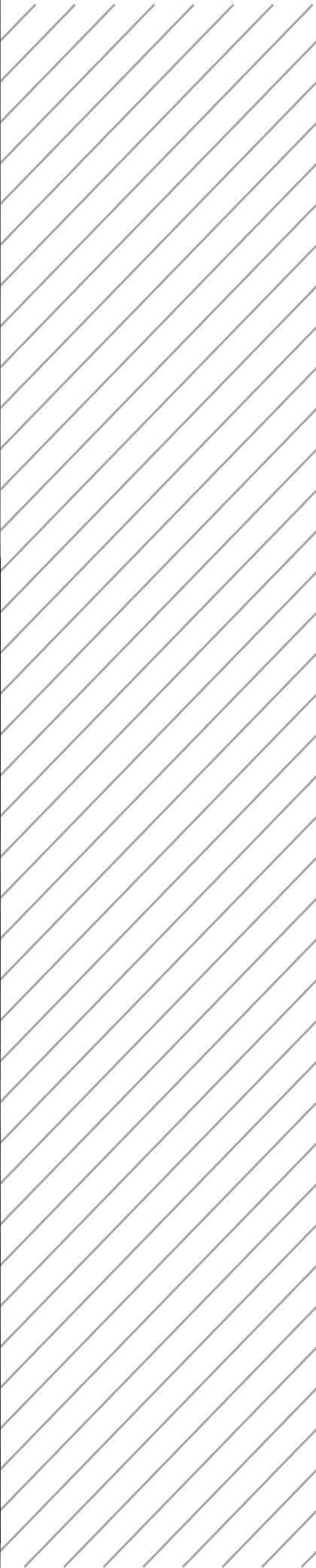

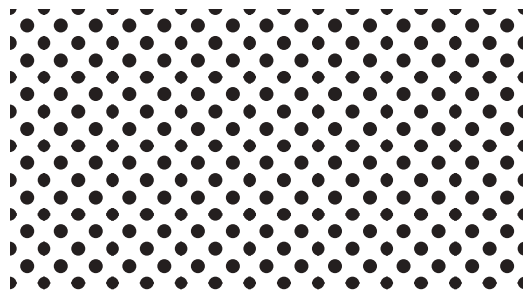
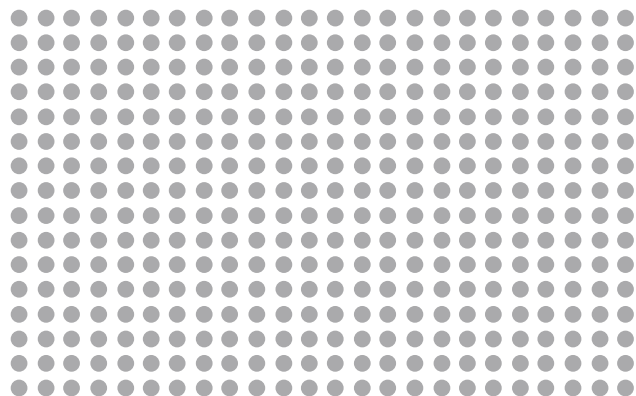

PUZZLE

design: Studio Italia Design 2014

THIS ELEGANT WALL AND CEILING LIGHT IS MADE OF METAL. THE LIGHT-FIXTURE IS COMPOSED OF SQUARE AND RECTILINEAR METALLIC PLATES AND PRODUCES A MINIMALIST MODERN ACCENT LIGHTING WHICH DISAPPEARS WHEN INSTALLED ON THE CEILING AND/OR WALL AND GIVES SPACE TO A LIGHT THAT, WITH ITS PLAYS AND WHIMS GIVES SHAPE TO AN ENCHANTING LIGHTING EFFECTS.

LAMPADE CHE SCOMPAIONO NEI NOSTRI SOFFITTI E NELLE NOSTRE PARETI LASCIANDO SPAZIO ALLA LUCE CON I SUOI GIOCHI E I SUOI CAPRICCI DANDO FORMA A SUGGESTIVI GIOCHI DI LUCE.



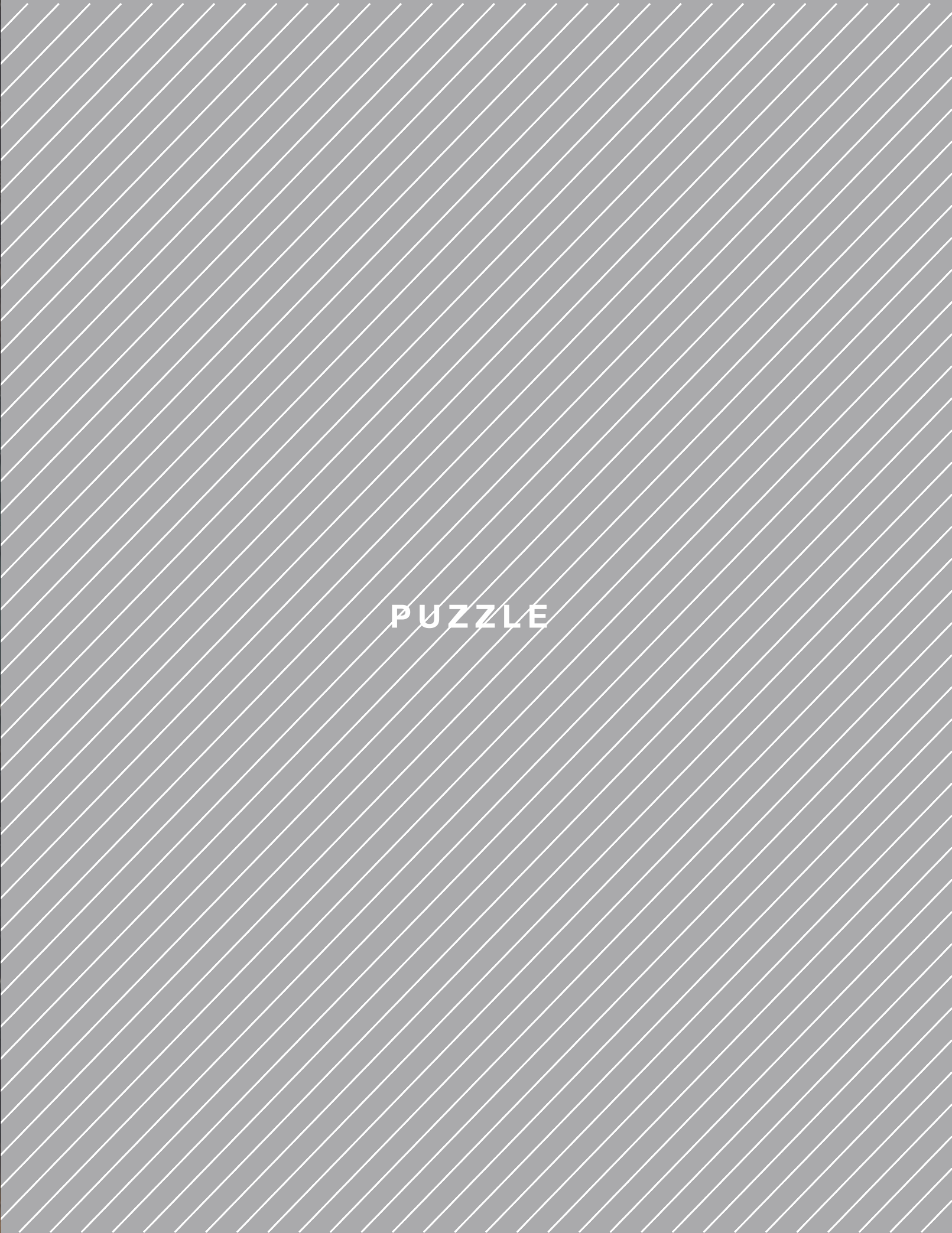

PUZZLE

PUZZLE
STUDIO
ITALIA
DESIGN





PUZZLE

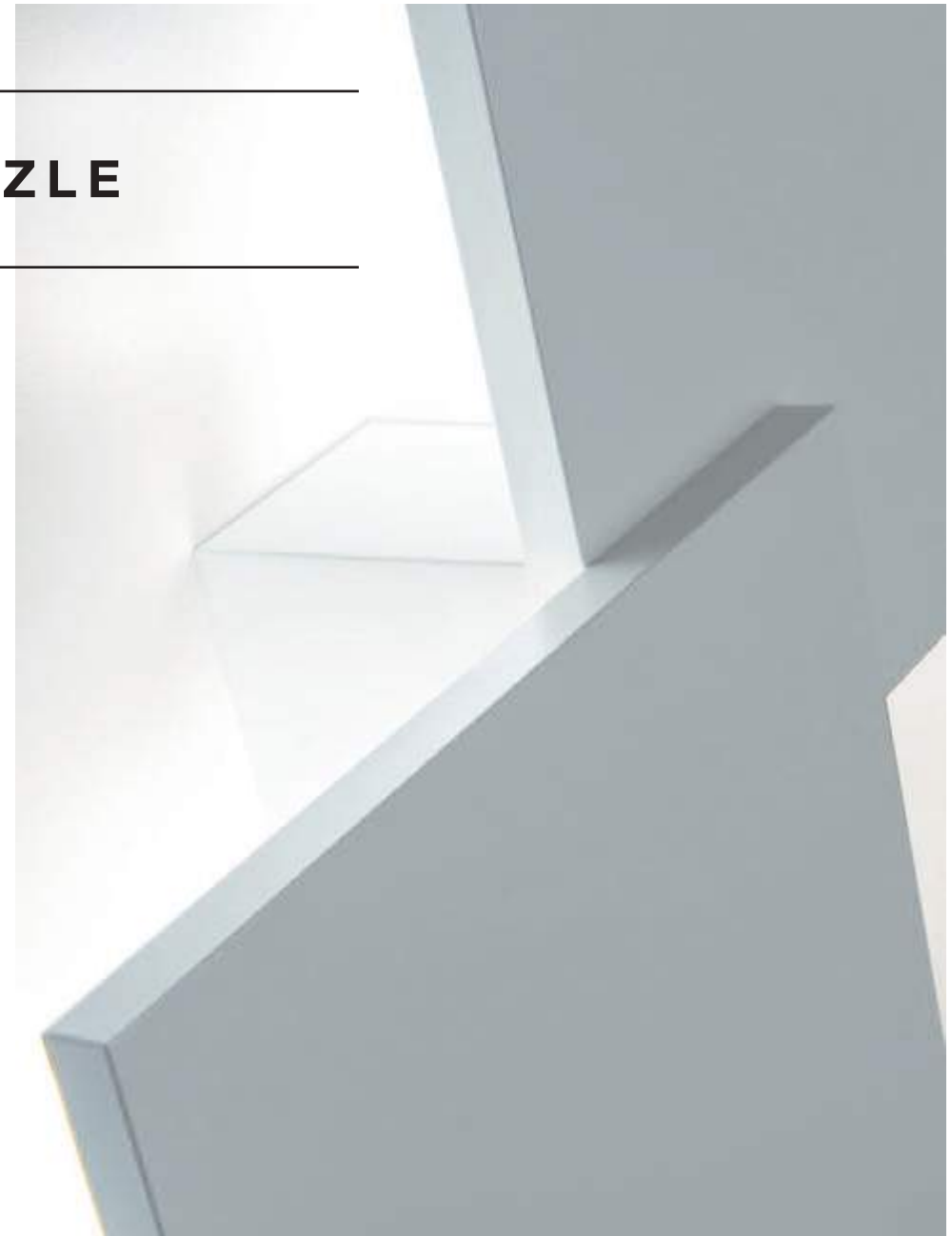

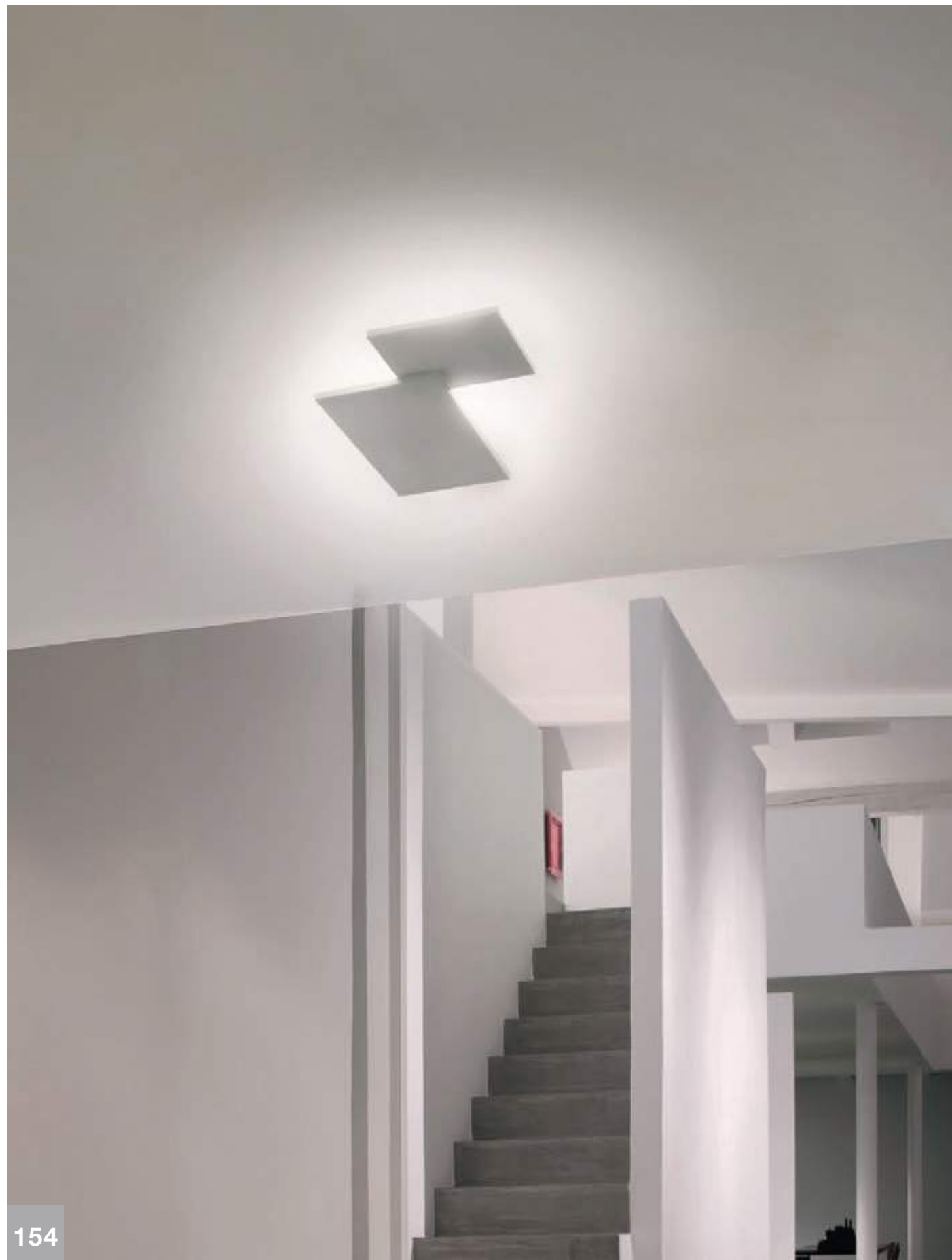







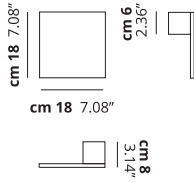





PUZZLE

MODELLO | MODEL LAMPADINA | LAMP MONTATURA | FRAME DIFFUSORE | DIFFUSER CODICE | CODE

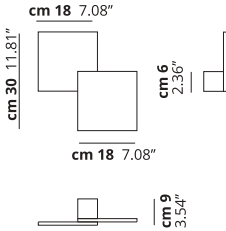





Puzzle Single Square Wall & Ceiling | Parete & Plafoniera

	LED 2700K 17W 1700 lm 210-250V CRI 92 MacAdam 3-Step	 Bianco Opaco 9016 Matte White 9016	NO NONE	146008		
	OR LED 3000K 17W 1800 lm 210-250V CRI 92 MacAdam 3-Step LED included			146004		
CE    		Peso netto: 1.16 Kg Net Weight:	Confezione Packaging	Peso Lordo: 1.67 Kg Gross Weight:	n. Colli: 1 n. Pack:	Volume m³: 0.013 Volume m³:

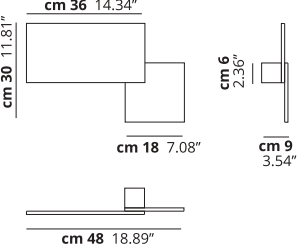





Puzzle Double Square Wall & Ceiling | Parete & Plafoniera

	LED 2700K 2x17W 3400 lm 210-250V CRI 92 MacAdam 3-Step	 Bianco Opaco 9016 Matte White 9016	NO NONE	146007		
	OR LED 3000K 2x17W 3600 lm 210-250V CRI 92 MacAdam 3-Step LED included			146003		
CE    		Peso netto: 2 Kg Net Weight:	Confezione Packaging	Peso Lordo: 2.68 Kg Gross Weight:	n. Colli: 1 n. Pack:	Volume m³: 0.015 Volume m³:

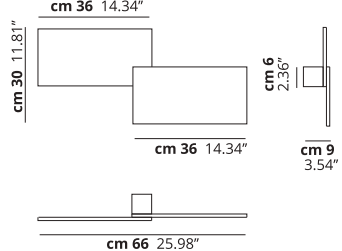
Puzzle Square & Rectangle Wall & Ceiling | Parete & Plafoniera

	LED 2700K 2x17W 3400 lm 210-250V CRI 92 MacAdam 3-Step	 Bianco Opaco 9016 Matte White 9016	NO NONE	146006		
	OR LED 3000K 2x17W 3600 lm 210-250V CRI 92 MacAdam 3-Step LED included			146002		
CE    		Peso netto: 2.85 Kg Net Weight:	Confezione Packaging	Peso Lordo: 3.64 Kg Gross Weight:	n. Colli: 1 n. Pack:	Volume m³: 0.021 Volume m³:

Puzzle Double Rectangle Wall & Ceiling | Parete & Plafoniera

	LED 2700K 2x17W 3400 lm 210-250V CRI 92 MacAdam 3-Step	 Bianco Opaco 9016 Matte White 9016	NO NONE	146005		
	OR LED 3000K 2x17W 3600 lm 210-250V CRI 92 MacAdam 3-Step LED included			146001		
CE    		Peso netto: 3.69 Kg Net Weight:	Confezione Packaging	Peso Lordo: 4.61 Kg Gross Weight:	n. Colli: 1 n. Pack:	Volume m³: 0.028 Volume m³:

Note | Notes: LED con alimentazione diretta a tensione di rete (non necessita di driver LED). Dimmerabile con varialuce a taglio di fase.
 LED with direct power supply to the AC line voltage (LED driver not required). Dimmable with phase cut dimming.

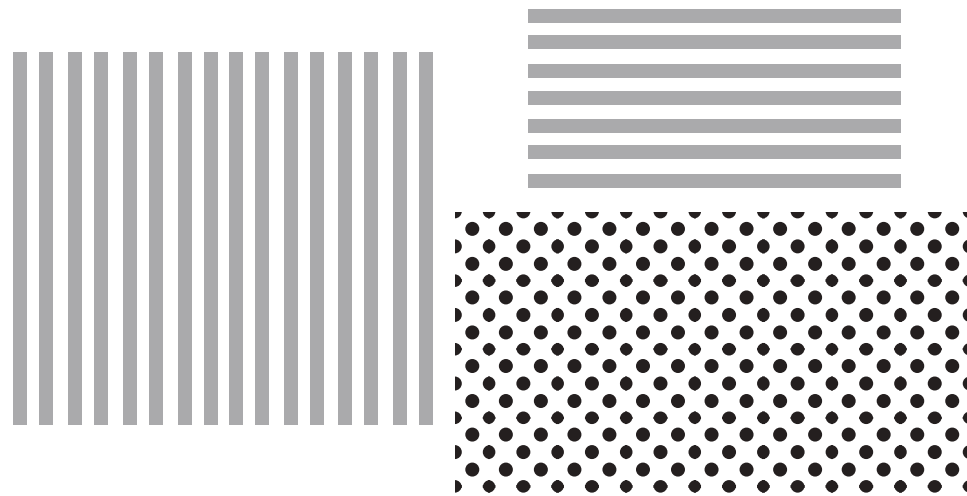

PUZZLE TWIST

design: Studio Italia Design 2014

AS THE NAME SUGGESTS, PUZZLE TWIST LED CEILING LIGHT ALLOWS YOU TO TWIST AND ALTER THE LIGHT WITH TWO ADJUSTABLE REFLECTORS. SUSPENDED JUST BELOW THE CEILING, THE LED LIGHT SOURCES ARE HIDDEN WITHIN THE FIXTURE, SENDING BRIGHT LIGHT ABOVE THE FIXTURE. THE TWO METAL REFLECTORS BREAK AWAY FROM THE CENTRAL SQUARE, SWIVELING WITH 40 DEGREES OF MOVEMENT, CREATING A UNIQUE LIGHT SOLUTION OF SHADOW PLAY AND GEOMETRIC SILHOUETTES.

DESIGN TECNICO, ESSENZIALE E RICERCATO DONA ALL'ILLUMINAZIONE LA PARTE DA PROTAGONISTA FORMANDO SUGGESTIVI E MAGICI GIOCHI DI LUCE.





PUZZLE
TWIST
STUDIO
ITALIA
DESIGN

THE
LIGHTING
MAKERS
2018

PUZZLE TWIST

MODELLO | MODEL LAMPADINA | LAMP MONTATURA | FRAME DIFFUSORE | DIFFUSER CODICE | CODE

Puzzle Twist Wall | Parete

	<p>2700K 17W 1700 lm LED 210-250V CRI 92 MacAdam 3-Step</p>	<p>● Bianco Opaco 9016 Matte White 9016</p>	<p>NO NONE</p>	146009		
	<p>OR</p> <p>3000K 17W 1800 lm LED 210-250V CRI 92 MacAdam 3-Step</p>			146010		
<p>CE ip20 Energy saving DIM TRIAC PG</p>		<p>Peso netto: 0.88 Kg Net Weight:</p>	<p>Confezione Packaging</p>	<p>Peso Lordo: 1.39 Kg Gross Weight:</p>	<p>n. Colli: 1 n. Pack:</p>	<p>Volume m³: 0.013 Volume m³:</p>

Puzzle Twist Ceiling | Plafoniera

	<p>2700K 2x17W 3400 lm LED 210-250V CRI 92 MacAdam 3-Step</p>	<p>● Bianco Opaco 9016 Matte White 9016</p>	<p>NO NONE</p>	146011		
	<p>OR</p> <p>3000K 2x17W 3600 lm LED 210-250V CRI 92 MacAdam 3-Step</p>			146012		
<p>CE ip20 Energy saving DIM TRIAC PG</p>		<p>Peso netto: 2.47 Kg Net Weight:</p>	<p>Confezione Packaging</p>	<p>Peso Lordo: 3.28 Kg Gross Weight:</p>	<p>n. Colli: 1 n. Pack:</p>	<p>Volume m³: 0.031 Volume m³:</p>

Note | Notes: LED con alimentazione diretta a tensione di rete (non necessita di driver LED). Dimmerabile con varialuce a taglio di fase.
LED with direct power supply to the AC line voltage (LED driver not required). Dimmable with phase cut dimming.

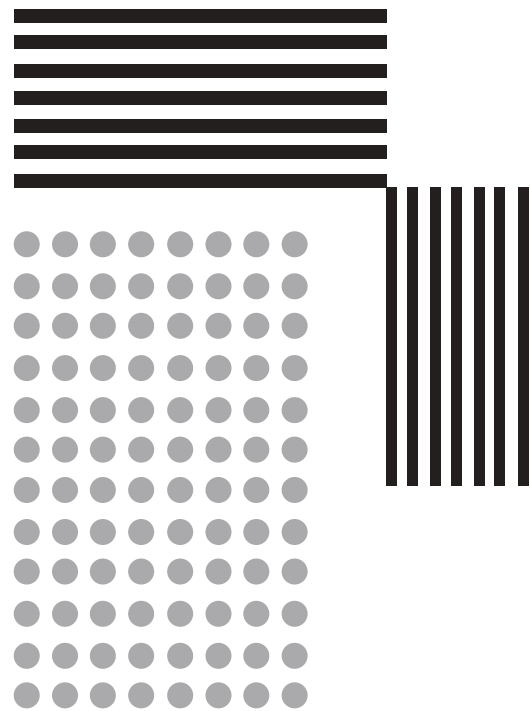

PUZZLE ROUND

design: Studio Italia Design 2016

THIS SINGLE AND DOUBLE PUZZLE ROUND WALL AND CEILING FIXTURE IS ENHANCED BY THE CHANCE TO PLAY WITH THE DISKS OF THE PUZZLE WITH FLEXIBLE JOINTS THAT CAN BE ADJUSTED IN VARIOUS WAYS TO CREATE A WONDERFUL LIGHTING EFFECTS FOR TURNING 355 DEGREES AND TILT UP TO 85 DEGREES. THE LED LIGHT SOURCE IS CONCEALED BEHIND THE ROUND REFLECTOR AND CASTS LIGHT AGAINST THE WALL.

PER CHI PREDILIGE LE FORME MORBIDE ABBIAMO RICREATO LA NOSTRA PUZZLE SENZA SPIGOLI, ESALTANDOLA CON LA POSSIBILITÀ DI GIOCARE CON GLI EFFETTI LUMINOSI.











PUZZLE ROUND

MODELLO | MODEL

LAMPADINA | LAMP

MONTATURA | FRAME

DIFFUSORE | DIFFUSER

CODICE | CODE

Puzzle Single Round Wall & Ceiling | Parete & Plafoniera

	2700K 17W 1700 lm LED 210-250V CRI 92 MacAdam 3-Step	● Bianco Opaco 9016 Matte White 9016 ● Bronzo Ramato Coppery Bronze	NO NONE	159001		
	OR 3000K 17W 1800 lm LED 210-250V CRI 92 MacAdam 3-Step LED included	● Bianco Opaco 9016 Matte White 9016 ● Bronzo Ramato Coppery Bronze Metallo Metal		159002		
CE ip20 Energy saving DIM TRIAC PG		Peso netto: 0.6 Kg Net Weight:	Confezione Packaging	Peso Lordo: 0.92 Kg Gross Weight:	n. Colli: 1 n. Pack:	Volume m³: 0.013 Volume m³:

Puzzle Double Round Wall & Ceiling | Parete & Plafoniera

	2700K 2x17W 3400 lm LED 210-250V CRI 92 MacAdam 3-Step	● Bianco Opaco 9016 Matte White 9016 ● Bronzo Ramato Coppery Bronze	NO NONE	159003		
	OR 3000K 2x17W 3600 lm LED 210-250V CRI 92 MacAdam 3-Step LED included	● Bianco Opaco 9016 Matte White 9016 ● Bronzo Ramato Coppery Bronze Metallo Metal		159004		
CE ip20 Energy saving DIM TRIAC PG		Peso netto: 1.1 Kg Net Weight:	Confezione Packaging	Peso Lordo: 1.54 Kg Gross Weight:	n. Colli: 1 n. Pack:	Volume m³: 0.023 Volume m³:



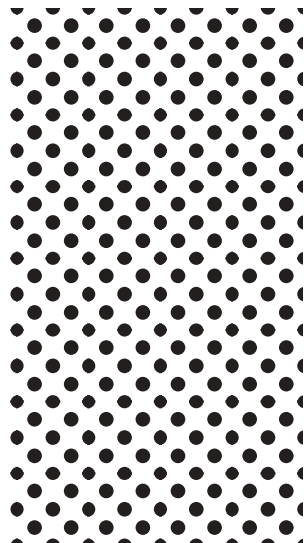

LASER CUBE

design: Studio Italia Design 2004/2015

POWERFUL BEAMS OF LIGHT POUR FROM THIS ELEGANT AND METALLIC WALL SCONCE. A SIMPLE METAL BOX IS LEFT OPEN-ENDED, WITH AN INTERIOR DESIGNED TO PUSH LIGHT STRICTLY AGAINST THE WALL FOR IDEAL INDIRECT LIGHT AVAILABLE AS A PERFECT CUBE OR AN ELONGATED RECTANGLE, THIS ARCHITECTURAL CONSTRUCTION SEEMS SIMPLE BUT IS QUITE TECHNOLOGICALLY SAVVY WITH POWERFUL INTEGRAL LED TECHNOLOGY EMBEDDED AT ITS CORE

STRUTTURA IN METALLO ELEGANTE E RAFFINATA CHE RIPRODUCE ESATTAMENTE LE FATTEZZE DI UN CUBO AL CUI INTERNO LA SUA ANIMA LED PERMETTE DI SPRIGIONARE FASCI DI LUCE INDIRETTA ORIENTATA SIA VERSO L'ALTO CHE VERSO IL BASSO CREANDO MAGNIFICI EFFETTI LUMINOSI CHE AFFASCINANO E VALORIZZANO L'AMBIENTE.



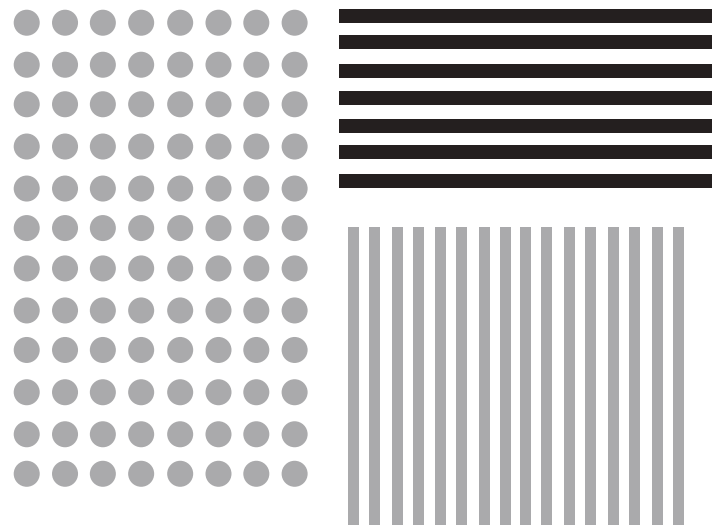

THOR

design: Andrea Tosetto 2015

NAMED AFTER THE MYTHICAL GOD, THE THOR WALL/CEILING LIGHT IS A BOLD LIGHTING FIXTURE THAT CREATES CUSTOMIZABLE LIGHTING EFFECTS THAT ARE SIMILAR TO THE DIFFERENT STAGES OF THE MOON. THE FLAT, ROUND SHADE IS MADE FROM METAL AND ATTACHES TO A GLASS CYLINDRICAL MOUNT. THE SHADE CAN BE MOVED UP AND DOWN THE CYLINDRICAL MOUNT ALLOWING FOR THE INCREASE OR DECREASE OF LIGHT OUTPUT FROM THE LED LIGHT SOURCE. DEPENDING ON THE POSITION OF THE REFLECTOR, DIVERSE LIGHT EFFECTS ARE CREATED.

IL PIACERE DI GOVERNARE LA LUCE PROPRIO COME UN DIO MITOLOGICO, PASSANDO DA UN'ECLISSI AD UNA LUNA PIENA. AGENDO SULLA STRUTTURA STESSA SI POSSONO RICREARE CENTINAIA DI SITUAZIONI LUMINOSE DIFFERENTI.





THE
LIGHTING
MAKERS
2018

THOR
STUDIO
ITALIA
DESIGN



THOR



MODELLO | MODEL

LAMPADINA | LAMP

MONTATURA | FRAME

DIFFUSORE | DIFFUSER

CODICE | CODE

Thor Small Wall & Ceiling | Parete & Plafoniera

<p>Ø cm 30 11.81" Ø cm 12 4.72" max cm 13 5.11" cm 12.5 4.92"</p>	<p>LED 3000K 17W 1800 lm 210-250V CRI 92 MacAdam 3-Step</p>	<p>● Bianco Opaco 9010 Matte White 9010</p>	<p>● Bianco Latte Lucido Glossy Milk White</p>	<p>152002</p>
<p>LED included</p>		<p>Metallo Metal</p>	<p>Policarbonato Polycarbonate</p>	
<p>CE ip40 Energy saving DIM TRIAC PG</p>		<p>Peso netto: 1.45 Kg Net Weight:</p>	<p>Confezione Packaging</p>	<p>Peso Lordo: 1.99 Kg Gross Weight: n. Colli: 1 n. Pack: Volume m³: 0.026</p>

Thor Medium Wall & Ceiling | Parete & Plafoniera

<p>Ø cm 60 23.62" Ø cm 16 6.29" max cm 20 7.87" cm 15.5 6.10"</p>	<p>LED 3000K 2x17W 3600 lm 210-250V CRI 92 MacAdam 3-Step</p>	<p>● Bianco Opaco 9010 Matte White 9010</p>	<p>● Bianco Latte Lucido Glossy Milk White</p>	<p>152001</p>
<p>LED included</p>		<p>Metallo Metal</p>	<p>Policarbonato Polycarbonate</p>	
<p>CE ip40 Energy saving DIM TRIAC PG</p>		<p>Peso netto: 3.7 Kg Net Weight:</p>	<p>Confezione Packaging</p>	<p>Peso Lordo: 5.55 Kg Gross Weight: n. Colli: 1 n. Pack: Volume m³: 0.115</p>

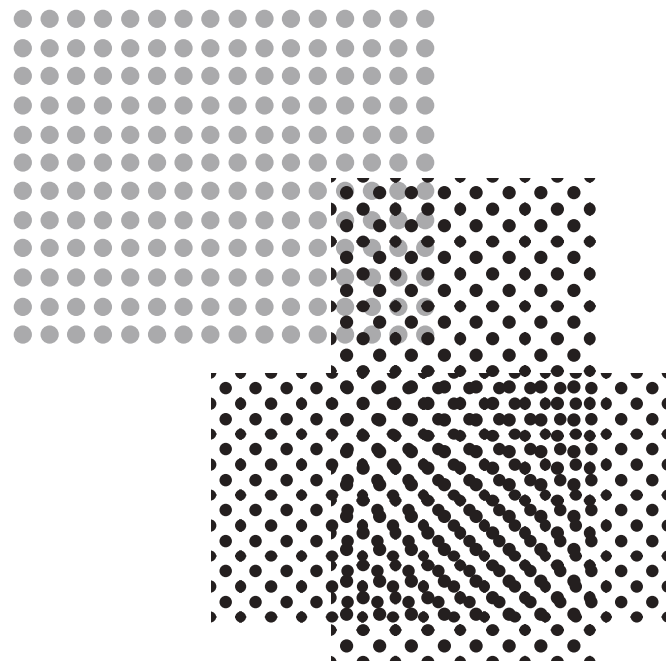

VALENTINA

design: Andrea Tosetto 2018

THE LUMINOUS REFLECTIONS GENERATED BY THE PRISMATIC DIFFUSER INSPIRED BY HIGH FASHION CREATE WONDERFUL PLAYS OF LIGHT, MAKING IT A PRECIOUS OBJECT ,GIVING REFINEMENT TO A UNIQUE AND UNMISTAKABLE COLLECTION.

LE BORCHIE LUMINOSE IMPREZIOSISCONO E VALORIZZANO IL SUO STILE ORIGINALE. VALENTINA LASCIA COSÌ IL SEGNO DI UNA PERSONALITÀ ELEGANTE E RAFFINATA PERMEATA DA QUELL' ALLURE ROMANTICA CHE LA CONTRADDISTINGUE.

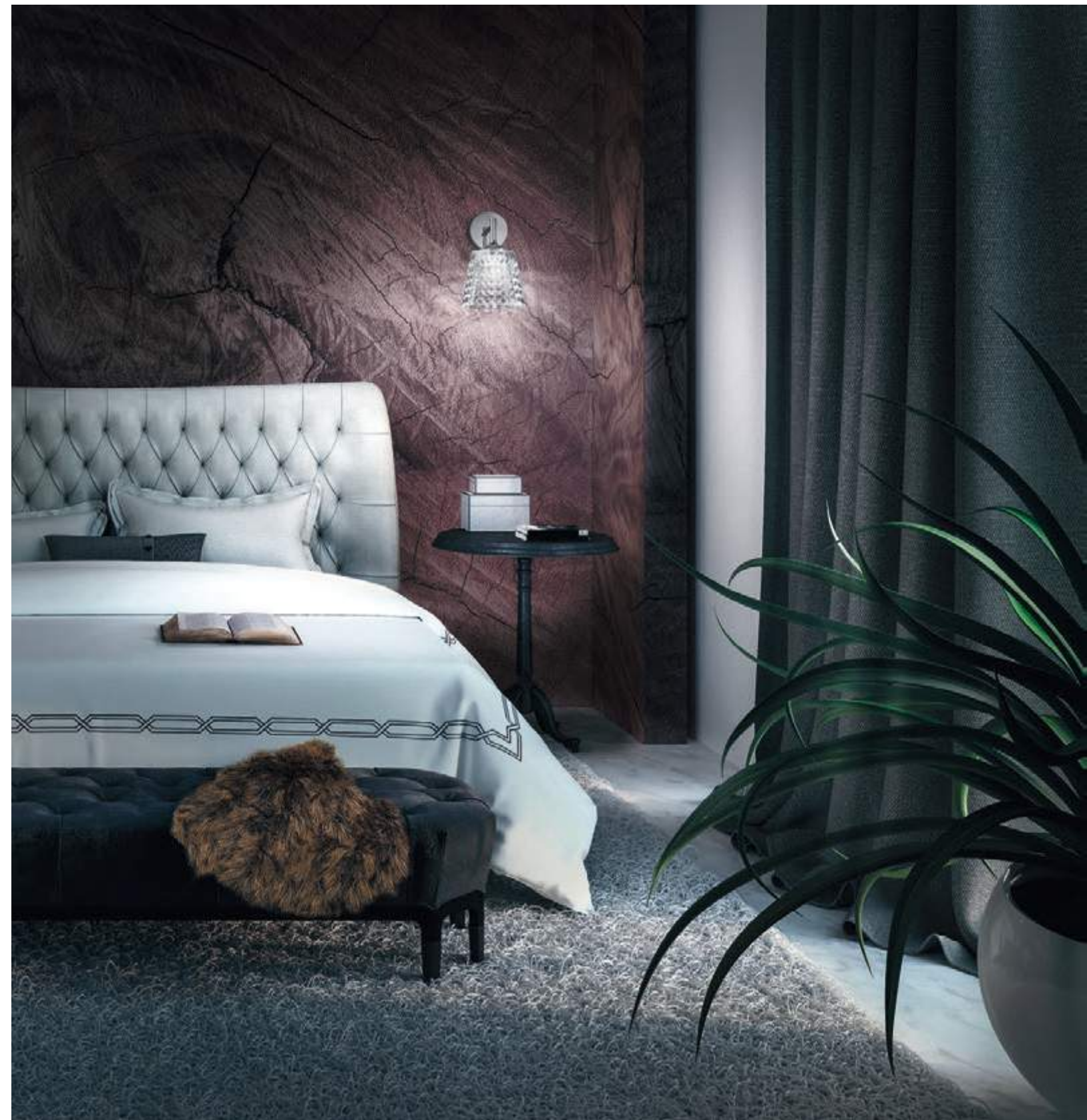





Shopping list

- cheese
- milk
- bread
- yoghurt
- dips
- lemon
- wine
- banana
- olive
- potato

THE LIGHTING MAKERS 2018





VALENTINA
STUDIO
ITALIA
DESIGN





VALENTINA
CORDLESS
AND
TABLE











5 HR FULL POWER
10 HR IN HALF POWER
15 HR IN A QUARTER OF POWER



• **DOUBLE TAP**
ON/OFF WITH MEMORY



• **TAP & HOLD**
CONTINUOUS DIM TO WARM
FROM 3300K TO 2600K



• **TRIPLE TAP**
THREE STEP DIM
3300K / 2950K / 2600K

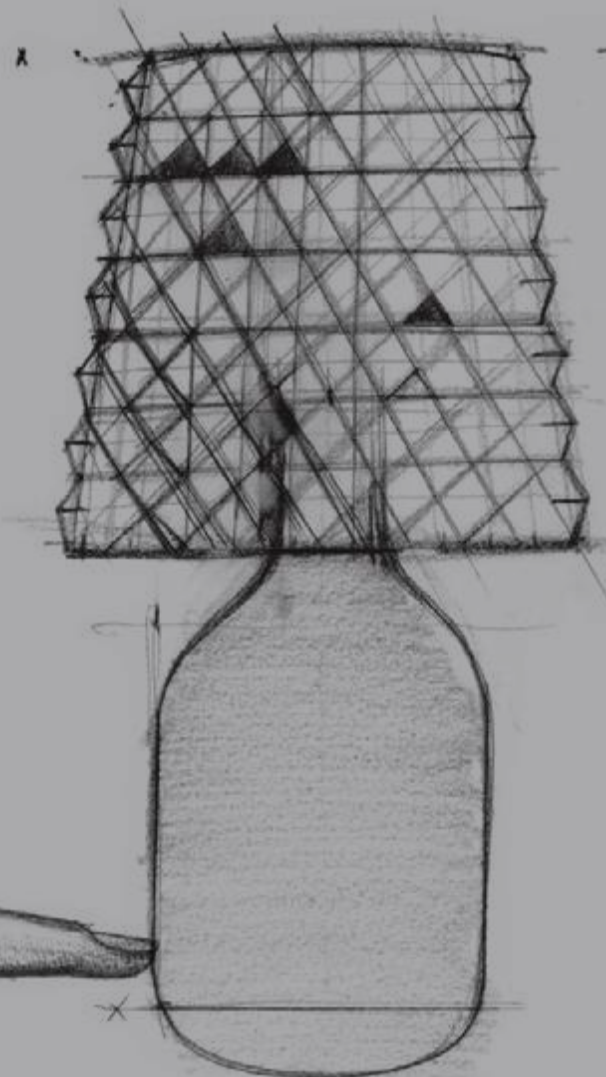

MIDDAY

SUNRISE



SUNSET



THE LIGHTING MAKERS 2018



VALENTINA composition

MODELLO | MODEL LAMPADINA | LAMP MONTATURA | FRAME DIFFUSORE | DIFFUSER CODICE | CODE

Valentina example of composition

[Ex: 1] Single Radial Suspension | Sospensione Singola Decentrata



[Ex: 2] Double Opposed Suspensions | Sospensioni Contrapposte

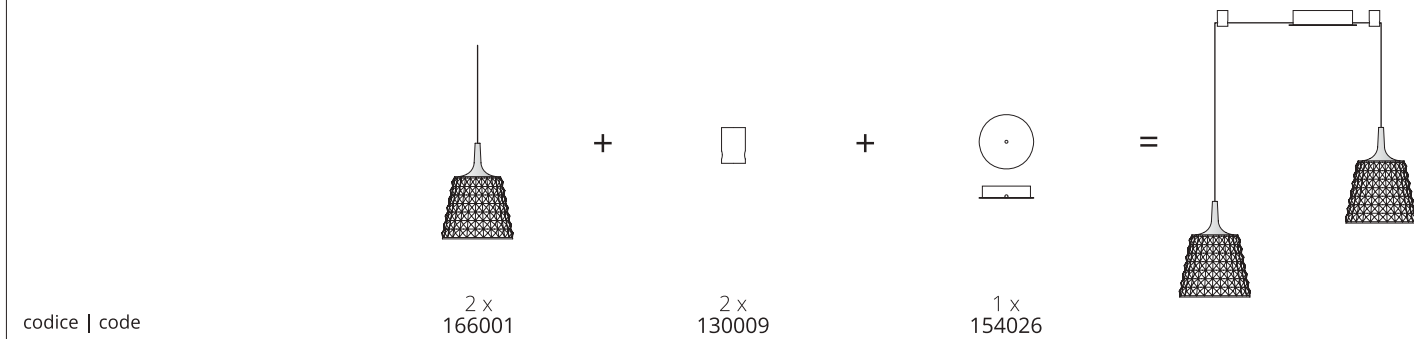

[Ex: 3] Cluster 3 Lights Composition | Composizione 3 Luci

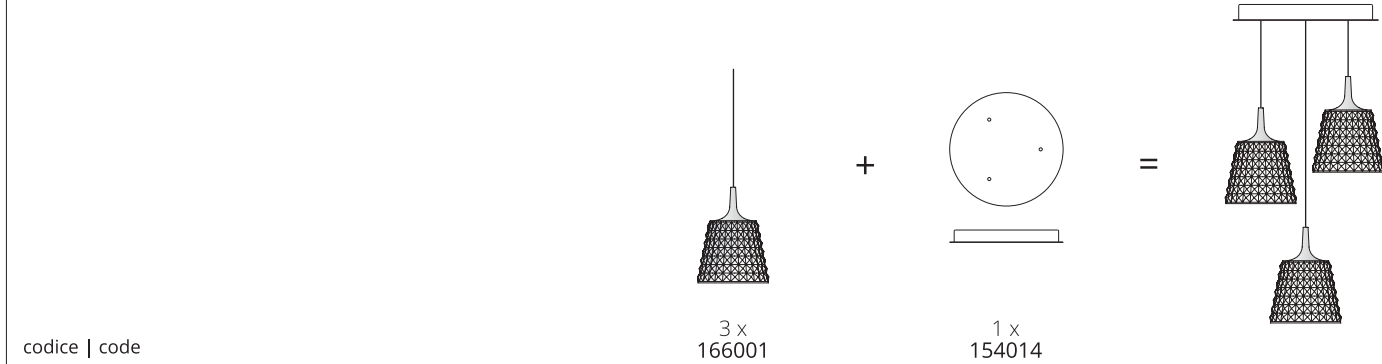

[Ex: 4] Short Track with 4 Lights | Binario Lineare Multiplo Corto 4 Luci

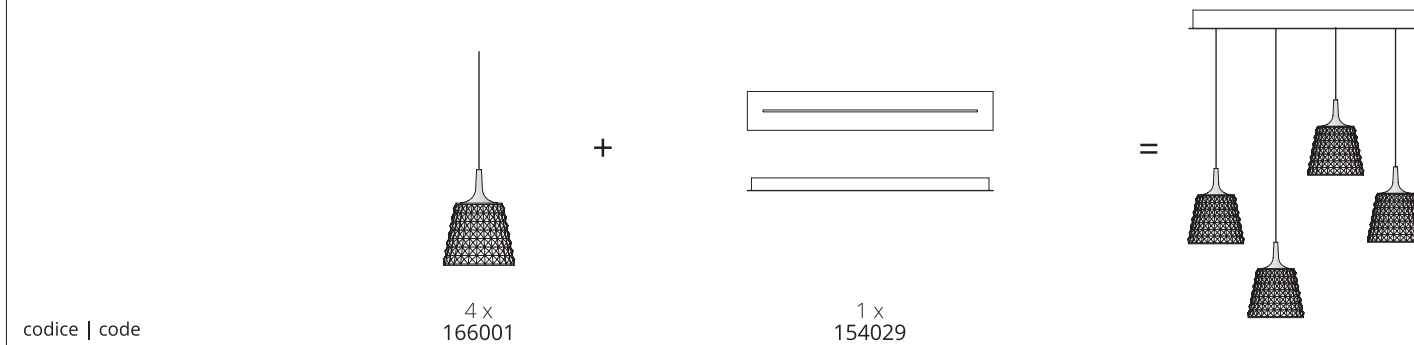

Note | Notes:

VALENTINA

MODELLO | MODEL LAMPADINA | LAMP MONTATURA | FRAME DIFFUSORE | DIFFUSER CODICE | CODE

Valentina Pendant | Sospensione

	<p>LED</p> <p>2700K 6.5W 600 lm 210-250V CRI 80 MacAdam 3-Step</p>	<p>Cromo Chrome</p>	<p>Cristallo Crystal</p>	<p>166001</p>
	<p>OR</p> <p>LED</p> <p>3000K 6.5W 650 lm 210-250V CRI 80 MacAdam 3-Step</p>			
<p>LED included</p>		<p>Metallo Metal</p>	<p>Polimetilmetacrilato PMMA</p>	<p>Peso netto: 0.45 Kg Confezione Packaging Peso Lordo: --- Kg n. Colli: 1 Volume m³: --- Net Weight: Gross Weight: n. Pack: Volume m³: ---</p>

Le sospensioni devono essere installate sui **rosoni** presenti alle pagine 360 - 365
 The pendants must be installed with one of the **canopy** options listed on page 360 - 365
 Les suspensions doivent être installées sur les **patères** présentées dans les pages 360 - 365
 Die Hängeleuchten sollen auf die **Rosetten** auf Seiten 360 - 365 montiert werden
 Las lámparas de suspensión se deben instalar en los **rósetones** a pagina 360 - 365

Note | Notes: LED con alimentazione diretta a tensione di rete (non necessita di driver LED). Dimmerabile con varialuce a taglio di fase.
 LED with direct power supply to the AC line voltage (LED driver not required). Dimmable with phase cut dimming.

VALENTINA

MODELLO | MODEL LAMPADINA | LAMP MONTATURA | FRAME DIFFUSORE | DIFFUSER CODICE | CODE

Valentina Wall | Parete

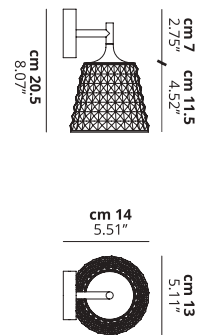
	<p>2700K 6.5W 600 lm 210-250V CRI 80 MacAdam 3-Step</p> <p>LED</p>	<p>OR</p> <p>● Cromo Chrome</p> <p>● Cromo Chrome</p>	<p>● Cristallo Crystal</p> <p>● Cristallo Crystal</p>	166003
	<p>3000K 6.5W 650 lm 210-250V CRI 80 MacAdam 3-Step</p> <p>LED</p>			166004
<p>LED included</p>		<p>Metallo Metal</p>	<p>Polimetilmetacrilato PMMA</p>	<p>Peso netto: 0.42 Kg Confezione Packaging Peso Lordo: -- Kg n. Colli: 1 Volume m³: --- Net Weight: Gross Weight: n. Pack: Volume m³: ---</p>



Note | Notes: LED con alimentazione diretta a tensione di rete (non necessita di driver LED). Dimmerabile con varialuce a taglio di fase.
LED with direct power supply to the AC line voltage (LED driver not required). Dimmable with phase cut dimming.

VALENTINA

MODELLO | MODEL LAMPADINA | LAMP MONTATURA | FRAME DIFFUSORE | DIFFUSER CODICE | CODE

Valentina Cordless Table | Tavolo

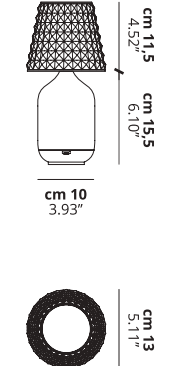
	<p>3300K to 2600K 3.5W 450 lm 210-250V CRI 80 MacAdam 3-Step 3400 mAh Battery</p> <p>LED</p>	<p>● Bianco Lucido 9010 Polished White 9010</p> <p>● Nero Lucido 9005 Polished Black 9005</p> <p>● Cromo Chrome</p> <p>● Oro Gold</p> <p>● Oro Rosa Rose Gold</p>	<p>● Cristallo Crystal</p> <p>● Cristallo Crystal</p>	166005
	<p>Memory Touch ON/OFF</p> <p>Continuous Touch DIM to WARM 3300K to 2600K</p> <p>Touch 3 Step DIM 3300K / 2950K / 2600K</p> <p>LED and BATTERY included</p>			166006
<p>LED and BATTERY included</p>		<p>Polimetilmetacrilato PMMA</p>	<p>Polimetilmetacrilato PMMA</p>	<p>Peso netto: 0.85 Kg Confezione Packaging Peso Lordo: 1.40 Kg n. Colli: 1 Volume m³: 0.01 Net Weight: Gross Weight: n. Pack: Volume m³: 0.01</p>

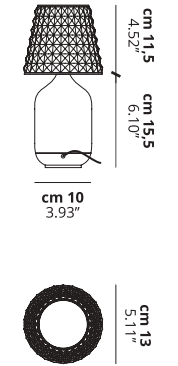

Valentina Table | Tavolo

	<p>2700K 6.5W 600 lm 210-250V CRI 80 MacAdam 3-Step</p> <p>LED</p>	<p>● Bianco Lucido 9010 Polished White 9010</p> <p>● Nero Lucido 9005 Polished Black 9005</p> <p>● Cromo Chrome</p> <p>● Oro Gold</p> <p>● Oro Rosa Rose Gold</p>	<p>● Cristallo Crystal</p> <p>● Cristallo Crystal</p>	166010
	<p>LED included</p>			166011
<p>DIMMER not included</p>		<p>Polimetilmetacrilato PMMA</p>	<p>Polimetilmetacrilato PMMA</p>	<p>Peso netto: 0.80 Kg Confezione Packaging Peso Lordo: 1.4 Kg n. Colli: 1 Volume m³: 0.01 Net Weight: Gross Weight: n. Pack: Volume m³: 0.01</p>



Note | Notes:

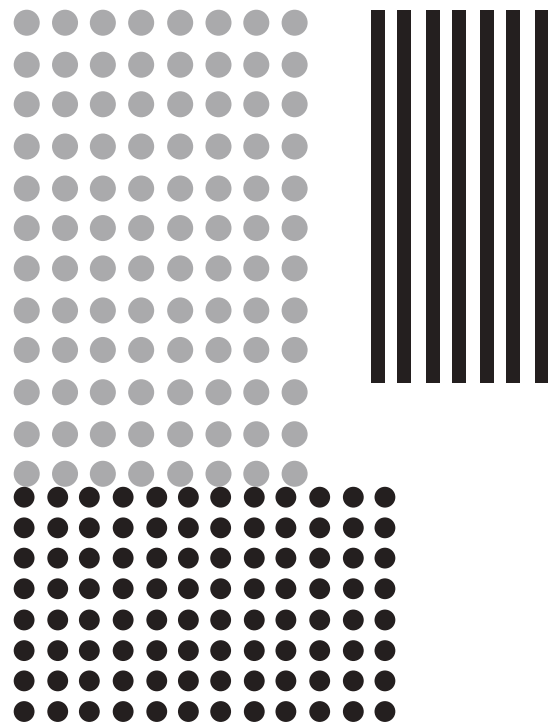

SUGEGASA

design: Andrea Tosetto 2017

THE NAME AND SHAPE OF THIS DESIGN REFERS TO A HEADGEAR OF THE SOUTHEAST ASIAN FARMERS WHO WORK THE LAND. THE LARGE-SCALE DIFFUSER IS MADE OF POLYCARBONATE WHEREAS THE CRYSTAL-LIKE SURFACE DIFFRACTS THE LIGHT IN A MAGICAL AND PRECIOUS MANNER. BECAUSE THE SYNTHETIC MATERIAL IS TRANSPARENT AND SLIGHTLY COLORED, SUGEGASA ALSO PROVIDES A SPECIAL TOUCH.

LA PERFEZIONE NELLA SEMPLICITÀ DELLE COSE. L'ARMONIA E L'EQUILIBRIO DELLE LINEE SEMPLICI E LEGGEREZZA DEL POLICARBONATO VENGONO COMBinate DA UNA SUPERFICIE PREZIOSA RENDENDOLA AFFASCINANTE SIA QUANDO È ILLUMINATA SIA QUANDO È SPENTA.







SUGE-
GASA



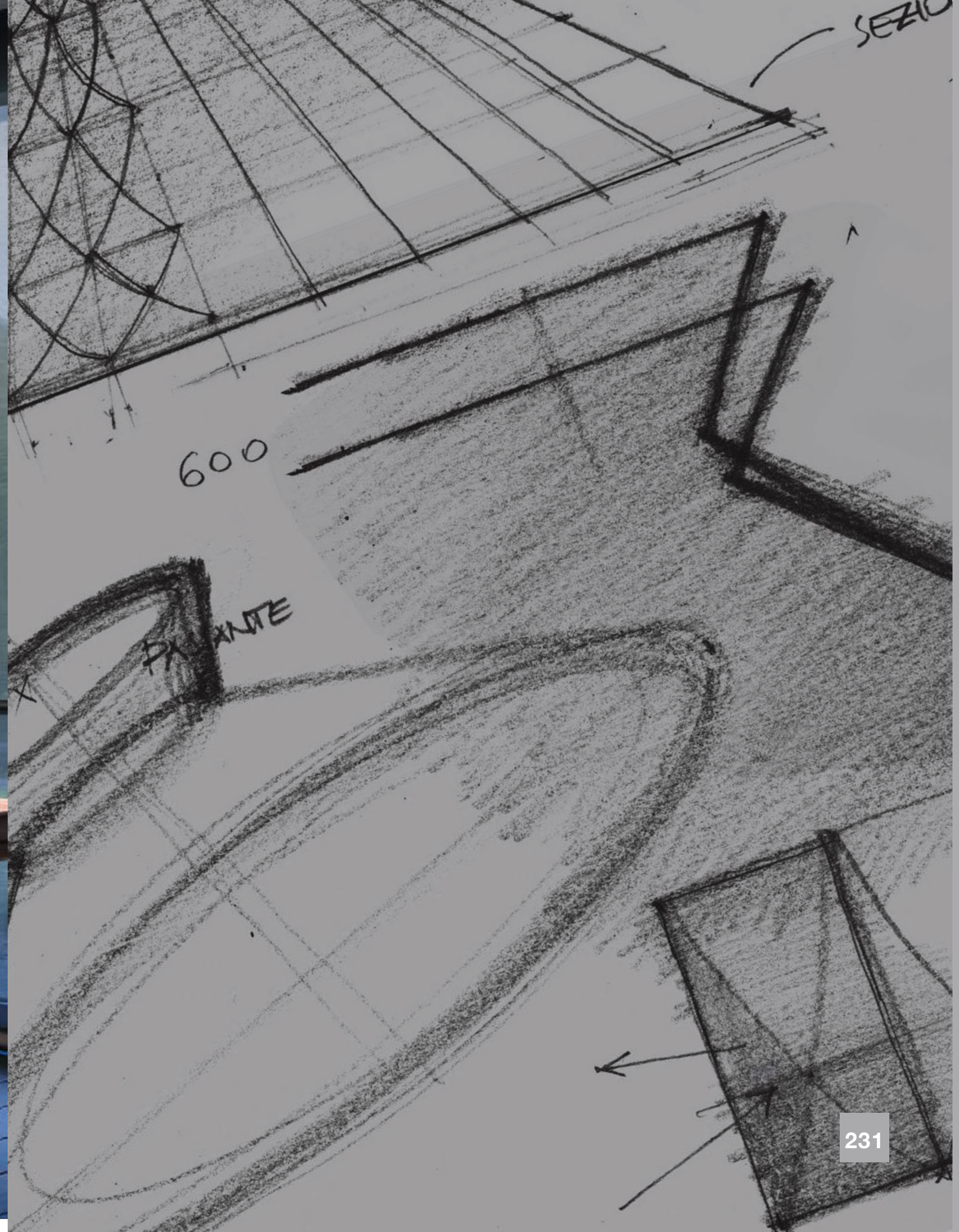



SUGEGASA

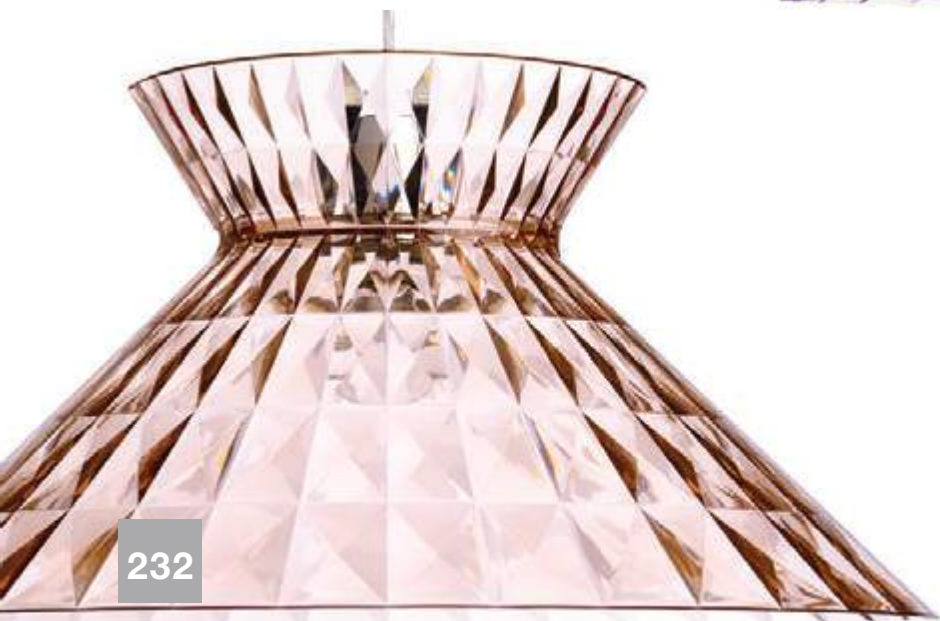



SUGEGASA

MODELLO | MODEL

LAMPADINA | LAMP

MONTATURA | FRAME

DIFFUSORE | DIFFUSER

CODICE | CODE

Sugegasa Pendant | Sospensione

<p>Ø cm 60 23.62"</p> <p>Ø cm 8 3.15"</p> <p>max cm 400 157.48"</p> <p>cm 29 11.41"</p>	<p>E27 G95 CFL 1 x max 23W</p> <p>OR</p> <p>E27 G95 LED 1 x max available</p> <p>Lampadine non incluse Bulbs not included</p>	<p>Cromo Chrome</p> <p>Metallo Metal</p>	<p>Cristallo Crystal</p> <p>Fumé Trasparente Clear Fumé</p> <p>Rosé Trasparente Clear Rosé</p> <p>Azzurro Trasparente Clear Azure</p> <p>Polimetilmetacrilato PMMA</p>	<p>163001</p> <p>163002</p> <p>163003</p> <p>163004</p>
<p>CE ip20 Energy saving DIM PG</p>		<p>Peso netto: 2.7 Kg Net Weight:</p>	<p>Confezione Packaging</p> <p>Peso Lordo: 5.80 Kg Gross Weight:</p> <p>n. Colli: 1 n. Pack:</p>	<p>Volume m³: 0.17 Volume m³:</p>

Note | Notes:

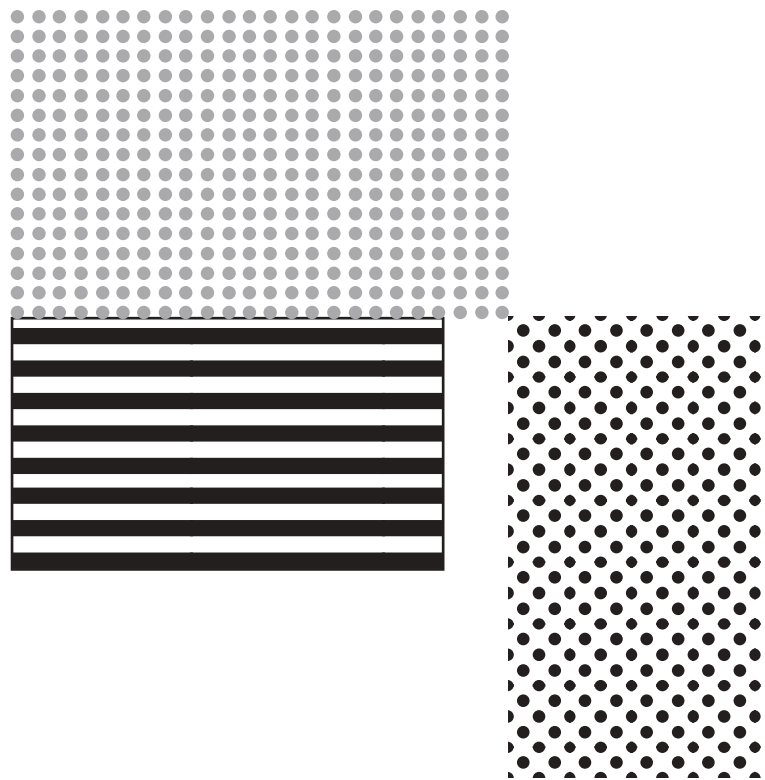

KELLY

design: Andrea Tosetto 2012/2013

SEDUCTIVE BEAUTY WITH CHARACTER THANKS TO A PERFECT LASER CUT OPENINGS THAT CREATES A PLAY OF LIGHT AND SHADOW. THE KELLY DESIGN IS A UNIQUE, LARGE SCALE PENDANT AVAILABLE IN VARIOUS SIZES. THE INNER GLASS DIFFUSER HIDES THE LIGHT SOURCE.

SEDUCENTE BELLEZZA INTRISA DI CARATTERE GRAZIE AI TAGLI A LASER DECISI E PRECISI, I QUALI CREANO GIOCHI DI LUCE ED OMBRE INTRIGANTI E PREZIOSI. CON IL SUO DESIGN SEMPLICE E SENZA TEMPO È GIÀ DIVENTATA UN MUST DI STUDIO ITALIA DESIGN.



BLACK
KELLY











KELLY
STUDIO
ITALIA
DESIGN



KELLY





KELLY

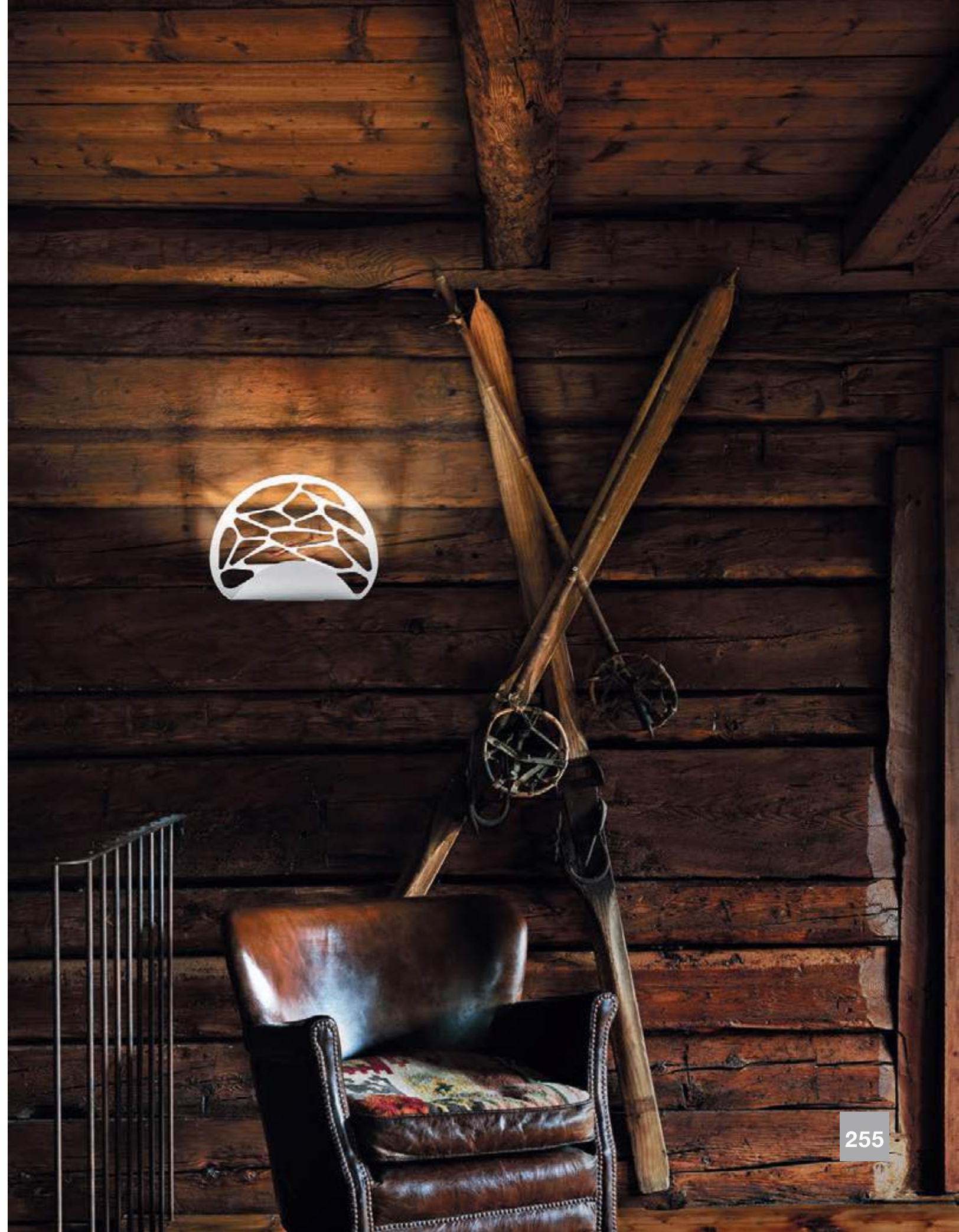

KELLY

MODELLO | MODEL LAMPADINA | LAMP MONTATURA | FRAME DIFFUSORE | DIFFUSER CODICE | CODE

Kelly Mini Sphere Standing | Appoggio

<p>cm 18 7.08" cm 7 2.75" Ø cm 18 7.08"</p>	<p>LED</p> <p>2700K 9W 900 lm 210-250V CRI 92 MacAdam 3-Step</p>	<p>● Bianco Opaco 9010 Matte White 9010</p> <p>● Bronzo Ramato Coppery Bronze</p>	<p>● Bianco Latte Lucido Glossy Milk White</p>	141006		
				141015		
<p>LED included</p>		<p>Metallo Metal</p>	<p>Vetro Glass</p>			
<p>CE, Energy saving, DIM TRIAC, DIMMER not included</p>		<p>Peso netto: 3 Kg Net Weight:</p>	<p>Confezione Packaging</p>	<p>Peso Lordo: 3.66 Kg Gross Weight:</p>	<p>n. Colli: 1 n. Pack:</p>	<p>Volume m³: 0.023 Volume m³:</p>

Kelly Small Sphere Standing | Appoggio

<p>cm 40 15.74" cm 17 6.69" Ø cm 40 15.74"</p>	<p>E27 Classic A60 3x max 46W eco</p> <p>OR</p> <p>E27 CFL [compact] 3x max 23W [L max cm 12]</p> <p>OR</p> <p>E27 LED 3x max available [L max cm 12]</p> <p>Lampadine non include Bulbs not included</p>	<p>● Bianco Opaco 9010 Matte White 9010</p>	<p>● Bianco Latte Lucido Glossy Milk White</p>	141007		
				141007		
<p>LED included</p>		<p>Metallo Metal</p>	<p>Vetro Glass</p>			
<p>CE, Energy saving, DIM, DIMMER included</p>		<p>Peso netto: 6 Kg Net Weight:</p>	<p>Confezione Packaging</p>	<p>Peso Lordo: 8.86 Kg Gross Weight:</p>	<p>n. Colli: 2 n. Pack:</p>	<p>Volume m³: 0.16 Volume m³:</p>

Kelly Large Sphere Standing | Appoggio

<p>cm 80 31.49" cm 30.5 12" Ø cm 80 31.49"</p>	<p>E27 Classic A60 4x max 46W eco</p> <p>OR</p> <p>E27 CFL [compact] 4x max 23W [L max cm 12]</p> <p>OR</p> <p>E27 LED 4x max available [L max cm 12]</p> <p>Lampadine non include Bulbs not included</p>	<p>● Bianco Opaco 9010 Matte White 9010</p>	<p>● Bianco Latte Lucido Glossy Milk White</p>	141008		
				141008		
<p>LED included</p>		<p>Metallo Metal</p>	<p>Vetro Glass</p>			
<p>CE, Energy saving, DIM, DIMMER included</p>		<p>Peso netto: 18 Kg Net Weight:</p>	<p>Confezione Packaging</p>	<p>Peso Lordo: 25.11 Kg Gross Weight:</p>	<p>n. Colli: 2 n. Pack:</p>	<p>Volume m³: 0.672 Volume m³:</p>

THE
LIGHTING
MAKERS
2018

Note | Notes: **Kelly Mini Sphere** - LED con alimentazione diretta a tensione di rete (non necessita di driver LED). Dimmerabile con varialuce a taglio di fase.
Kelly Mini Sphere - LED with direct power supply to the AC line voltage (LED driver not required). Dimmable with phase cut dimming.

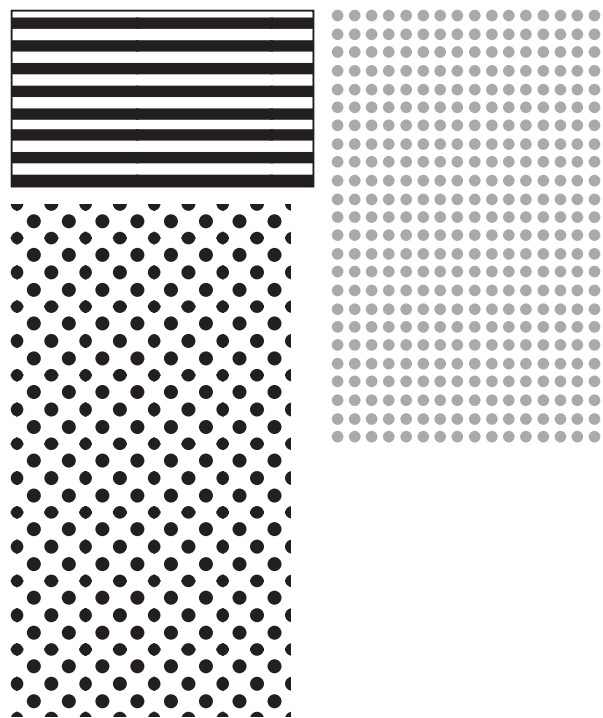

KELLY CLUSTER

design: Andrea Tosetto 2014

AS AN OFFSHOOT OF THE LARGE KELLY, THIS SMALL SCULPTED PIECE ALLOWS YOU TO CREATE CLUSTERS ABLE TO SATISFY THE MOST DEMANDING DESIGNS BY CREATING FASCINATING COMPOSITIONS FULL OF PERSONALITY. SHOWCASING A UNIQUE LASER PATTERN, THE SHADE HOUSES AN LED MODULE WHICH WHEN ILLUMINATED, CASTS LIGHT THROUGH A GLASS DIFFUSER CREATING DIFFUSED AMBIENT LIGHTING.

NATA DA KELLY, QUESTA PICCOLA PALLINA INTAGLIATA PERMETTE DI CREARE DEI CLUSTER CAPACI DI SODDISFARE QUALSIASI TIPO DI ESIGENZA CREANDO DELLE COMPOSIZIONI AFFASCINANTI E DI GRANDE PERSONALITÀ.







BLACK
KELLY
CLU-
STER



KELLY
CLUSTER
STUDIO
ITALIA
DESIGN

THE
LIGHTING
MAKERS
2018



STUDIO
ITALIA DESIGN
LIGHTING MAKERS



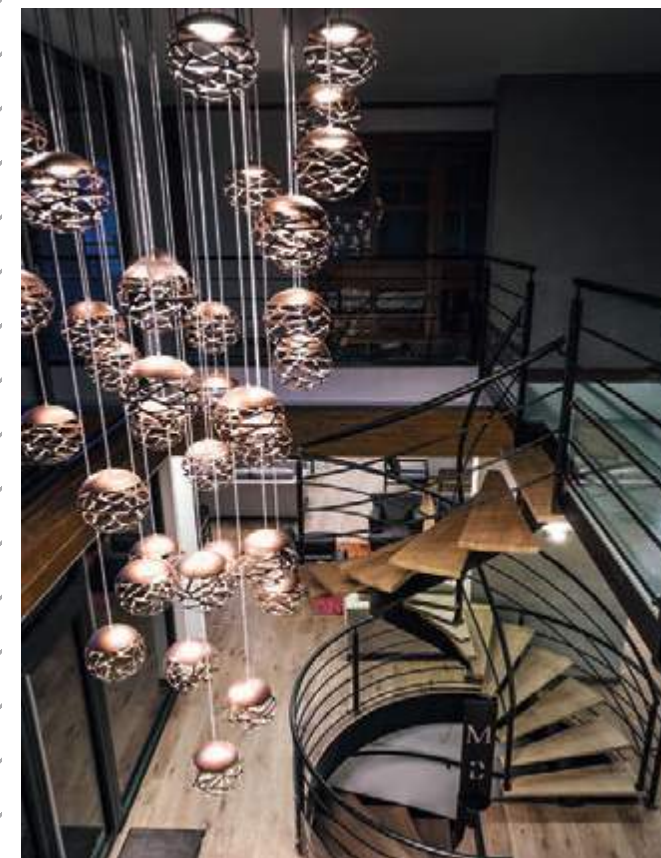

KELLY CLUSTER



KELLY CLUSTER

composition

MODELLO | MODEL LAMPADINA | LAMP MONTATURA | FRAME DIFFUSORE | DIFFUSER CODICE | CODE

Kelly Cluster example of composition

[Ex: 1] Single Mini Suspension | Sospensione Singola Mini

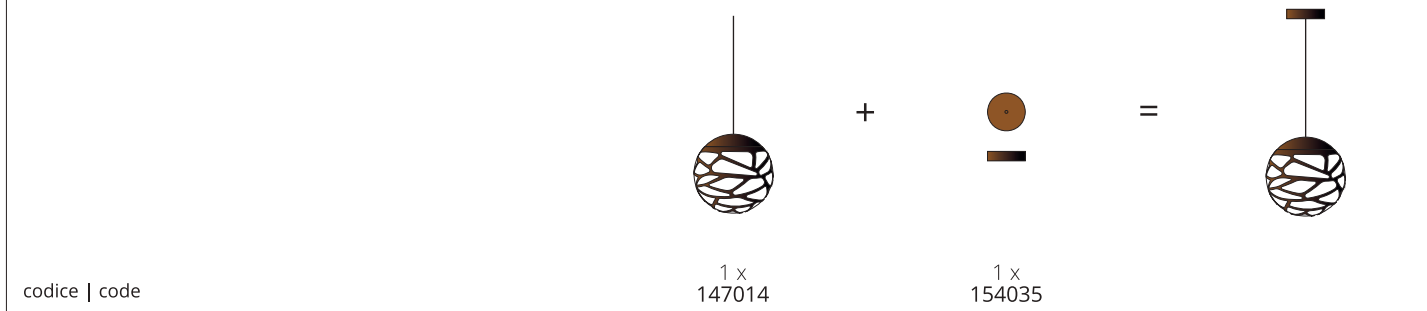

[Ex: 2] Double Opposed Suspensions | Sospensioni Contrapposte



[Ex: 3] Cluster 3 Lights Composition | Composizione 3 Luci



[Ex: 4] Short Track with 4 Lights | Binario Lineare Multiplo Corto 4 Luci

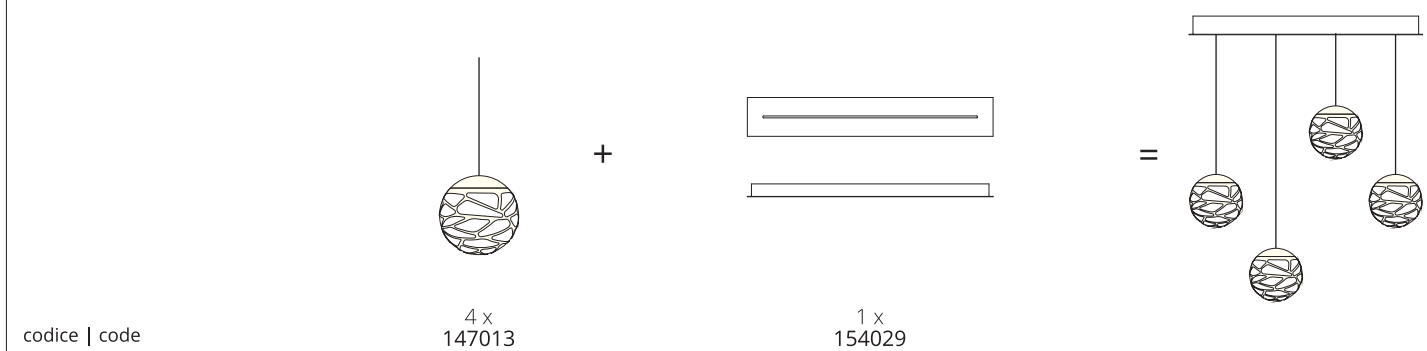

Note | Notes:

KELLY CLUSTER

MODELLO | MODEL LAMPADINA | LAMP MONTATURA | FRAME DIFFUSORE | DIFFUSER CODICE | CODE

Kelly Cluster Sphere Pendant | Sospensione

<p>LED 2700K 9W 900 lm 210-250V CRI 92 MacAdam 3-Step</p> <p>LED included</p>	<p>Bianco Opaco 9010 Matte White 9010</p> <p>Nero Opaco Matte Black</p> <p>Bronzo Ramato Coppery Bronze</p> <p>Metallo Metal</p>	<p>Bianco Latte Lucido Glossy Milk White</p> <p>Vetro Glass</p>	<p>147013</p> <p>147015</p> <p>147014</p>
<p>CE ip40 Energy saving DIM TRIAC PG</p>	<p>Peso netto: 0.8 Kg Net Weight:</p>	<p>Confezione Packaging</p>	<p>Peso Lordo: 1.46 Kg Gross Weight: n. Colli: 1 n. Pack: 1 Volume m³: 0.023</p>

Le sospensioni devono essere installate sui **rosoni** presenti alle pagine 360 - 365
 The pendants must be installed with one of the **canopy** options listed on page 360 - 365
 Les suspensions doivent être installées sur les **patères** présentées dans les pages 360 - 365
 Die Hängeleuchten sollen auf die **Rosetten** auf Seiten 360 - 365 montiert werden
 Las lámparas de suspensión se deben instalar en los **rosetones** a pagina 360 - 365

Note | Notes: LED con alimentazione diretta a tensione di rete (non necessita di driver LED). Dimmerabile con varialuce a taglio di fase.
 LED with direct power supply to the AC line voltage (LED driver not required). Dimmable with phase cut dimming.

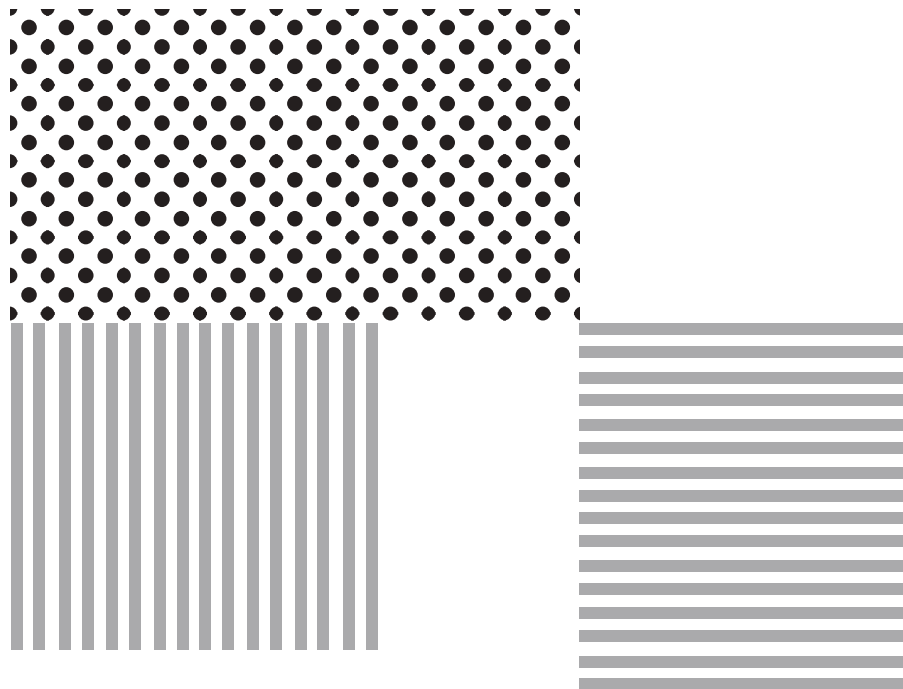

MAGGIO

design: Marta Sansoni 2016

FROM THE HALLMARK OF MARTHA SANSONI WAS BORN MAGGIO – A SYMBOL OF INTENSE AND SEDUCTIVE SPRING EVOCATION WITH MAGICAL AND SUGGESTIVE LIGHT EFFECTS, ACHIEVED BY ITS CARVINGS COMBINED WITH SPREAD (DIFFUSED) AND INDIRECT LIGHT. ITS LASER CUTTED METAL STRUCTURE WITH DECORATIVE PERFORATIONS GIVES LIGHT AND ELEGANT LOOK THANKS ALSO TO ITS SOFT SURFACE, RESEMBLING BRANCHES INTERSECTED WITH EACH OTHER, LIKE SYMBOL OF A SPONTANEOUS AND LUSH VEGETATION, BRINGS ORGANIC AND DETERMINED DESIGN WITHOUT BEING INTRUSIVE IN THE INTERIOR.

LE DECORAZIONI CHE SI INTERSECANO TRA LORO RICORDANO RAMI, EVOCANDO LA PRIMAVERA CON GIOCHI DI LUCE MAGICI E SUGGESTIVI. DONA AGLI INTERNI UN DESIGN ORGANICO DI CARATTERE, MA MAI INVADENTE.



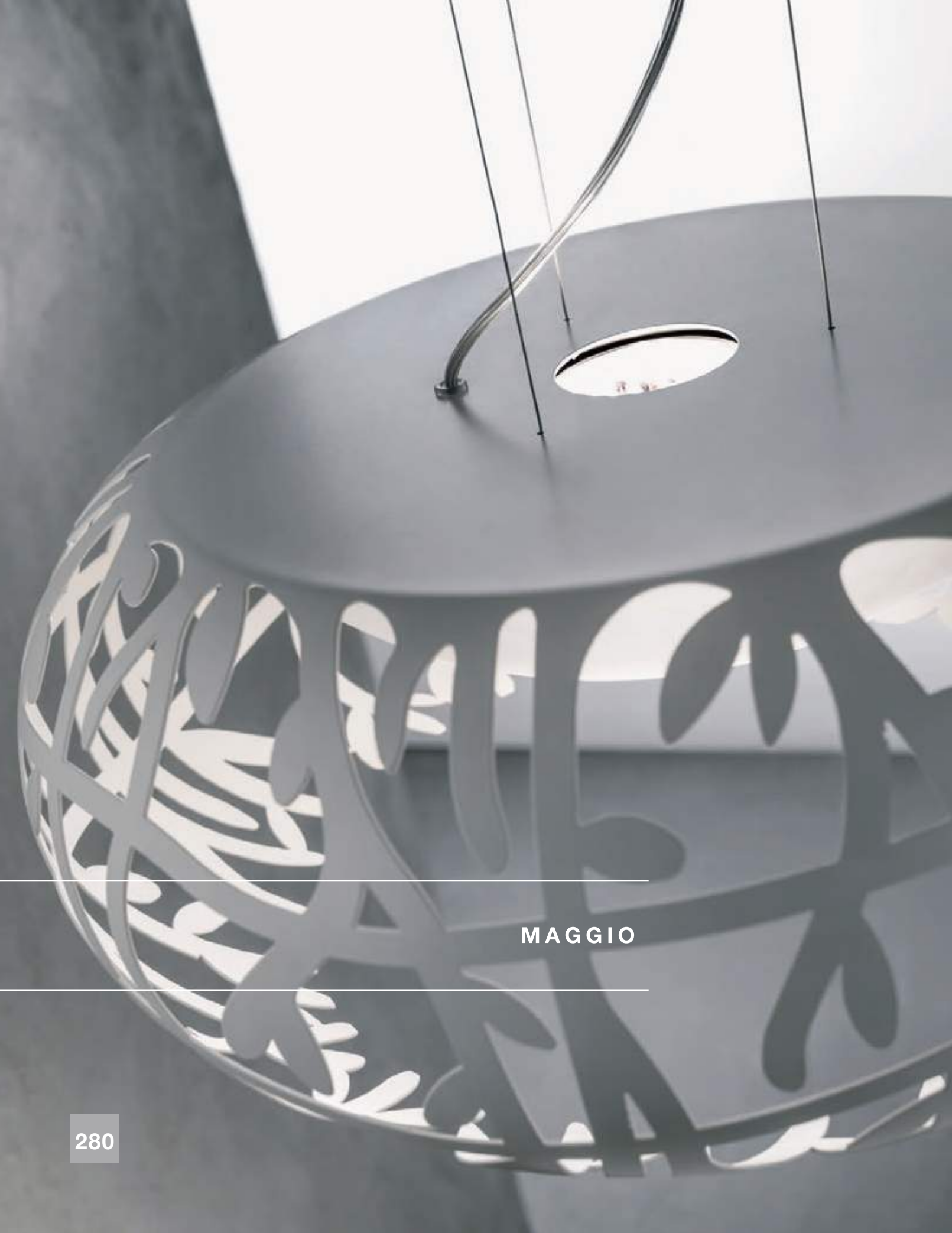

MAGGIO







MAGGIO

MODELLO | MODEL LAMPADINA | LAMP MONTATURA | FRAME DIFFUSORE | DIFFUSER CODICE | CODE

Maggio Pendant | Sospensione

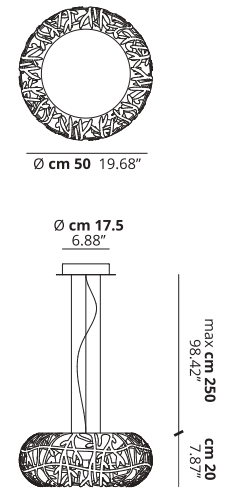
	<p>LED</p> <p>2700K ▲ 17W 1700 lm ▼ 17W 1700 lm 210-250V CRI 92 MacAdam 3-Step</p>	<p>● Bianco Opaco 9010 Matte White 9010</p> <p>● Bronzo Ramato Coppery Bronze</p>	<p>○ Bianco Satinato Matte White</p>	<p>162001</p> <p>162002</p>
<p>LED included</p>		<p>Metallo Metal</p>	<p>Polycarbonato Polycarbonate</p>	<p>Peso netto: 6 Kg Confezione Packaging Peso Lordo: 8.27 Kg n. Colli: 1 Volume m³: 0.09 Net Weight: Gross Weight: n. Pack: Volume m³:</p>

Note | Notes: LED con alimentazione diretta a tensione di rete (non necessita di driver LED). Dimmerabile con varialuce a taglio di fase.
 LED with direct power supply to the AC line voltage (LED driver not required). Dimmable with phase cut dimming.

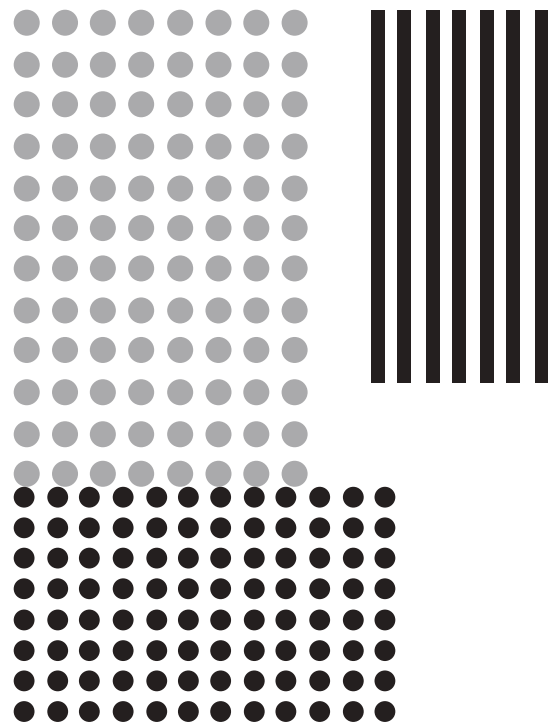

NOSTALGIA

design: Dima Loginoff 2015

A PERFECT BLEND OF RETRO AND MODERN, THIS DECORATIVE PENDANT DESIGN IS MADE FROM BLOWN GLASS AND UTILIZES THE MOST ADVANCED LED TECHNOLOGY. SMALL, MEDIUM, LARGE IN FOUR DIFFERENT RICH COLORS: GOLD, SILVER, ROSE GOLD AND CLEAR GLASS GIVES THE POSSIBILITY TO CREATE AND PLAY WITH THE FIXTURES, CREATING A CONTACT WITH THE SAME AND ALLOWING CUSTOMIZATION OF THE COMPOSITIONS. THESE DETAILS AND MATERIALS, USED IN THEIR CREATION, CHARACTERIZES THE INFLUENCE OF THE VENETIAN CONTEXT WHERE THE COMPANY RESIDES, CAREFUL AND HIGH-QUALITY WORKMANSHIP OF THE GLASS REFLECTS THE ANCIENT TRADITION OF GLASS. THE CHROME METAL STRUCTURE HOLDS THE LED LIGHT SOURCE, WHICH PRODUCES A WARM LIGHT THAT BECOMES SLIGHTLY VISIBLE ONCE LIT. THE REFLECTIVE ELEMENT OF THE GLASS REMAINS CONSTANT, YET CHANGES WITH THE ADVENT OF THE LIGHT THAT PEERS THROUGH THE GLASS.

FORMA RETRÒ CHE SI FONDE CON L'ATTUALITÀ. SI UNISCONO COSÌ LA MAESTRIA NELL'ARTE DEL VETRO CON LA PIÙ AVANZATA TECNOLOGIA LED PERMETTENDO COMPOSIZIONI AMPIE ED ARMONIOSE PER ILLUMINARE DAL TAVOLO DA PRANZO ALLA LUSSUOSA HALL DI UN GRANDE ALBERGO. AFFASCINA CON LE SUE DIVERSE E PREZIOSE FINITURE.





NOSTALGIA

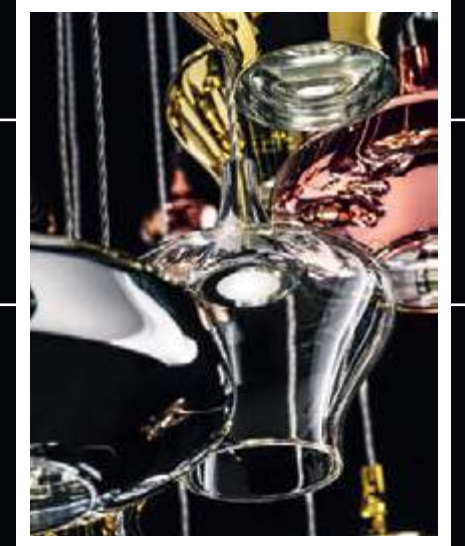





NOSTALGIA
STUDIO
ITALIA
DESIGN



NOSTALGIA

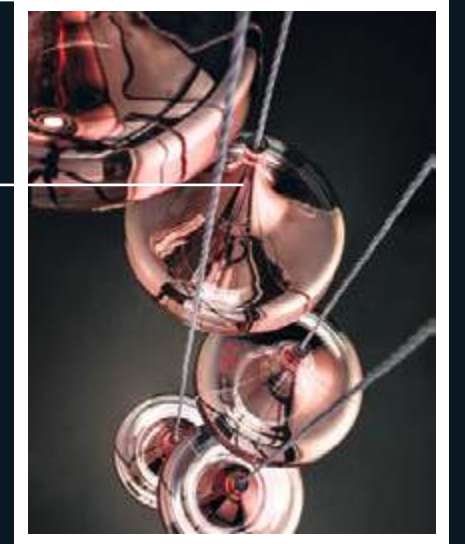











NOSTALGIA composition

MODELLO | MODEL LAMPADINA | LAMP MONTATURA | FRAME DIFFUSORE | DIFFUSER CODICE | CODE

Nostalgia example of composition

[Ex: 1] Single Radial Suspension | Sospensione Singola Decentrata

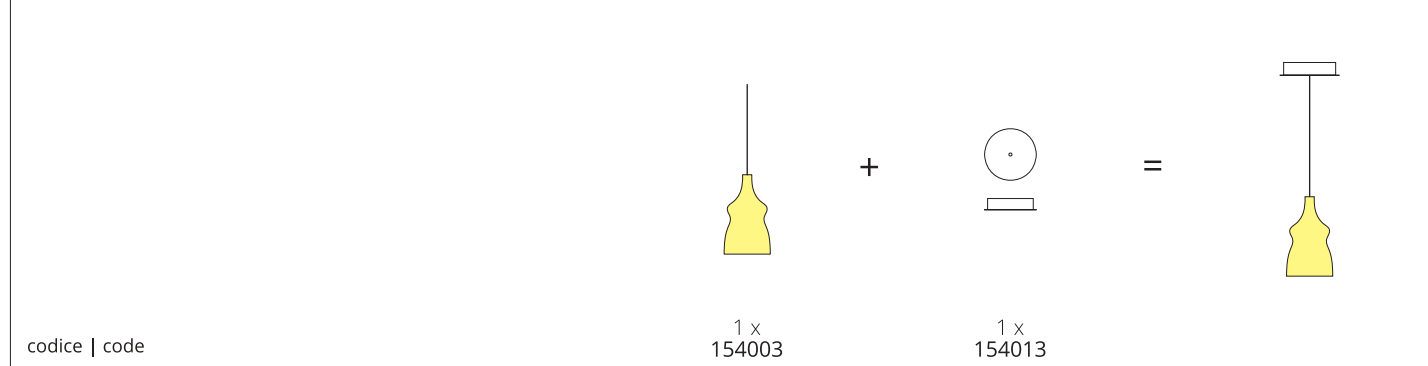

[Ex: 2] Double Opposed Suspensions | Sospensioni Contrapposte

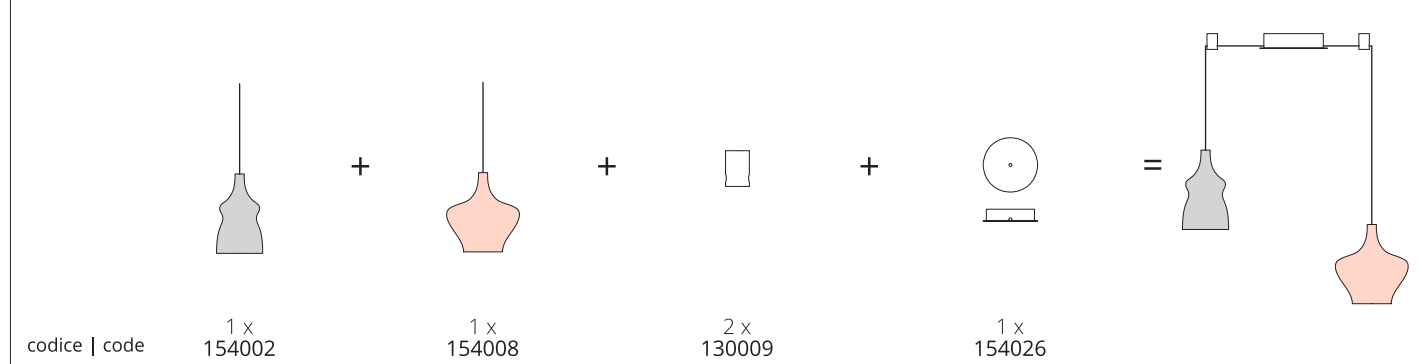

[Ex: 3] Cluster Rectangular 7 Lights Composition | Composizione 7 Rettangolare Luci

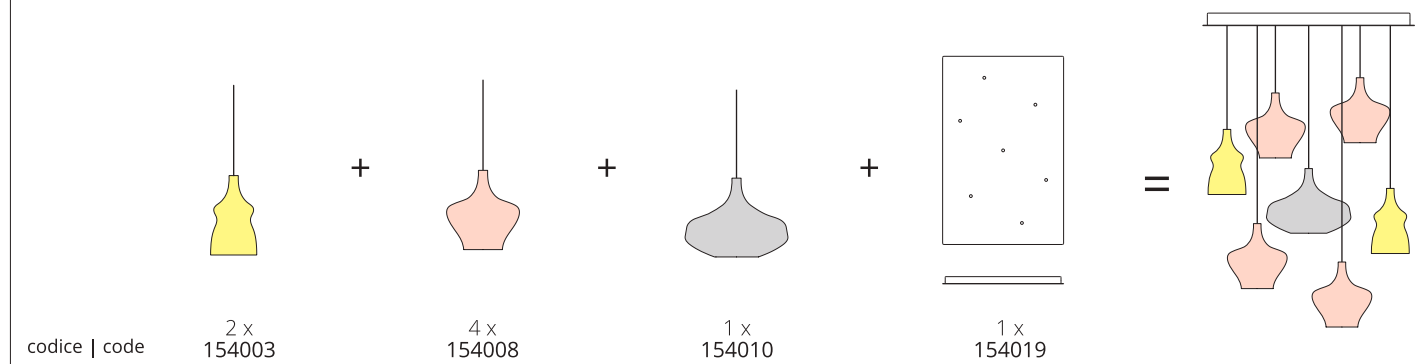

[Ex: 4] Short Track with 4 Lights | Binario Lineare Multiplo Corto 4 Luci

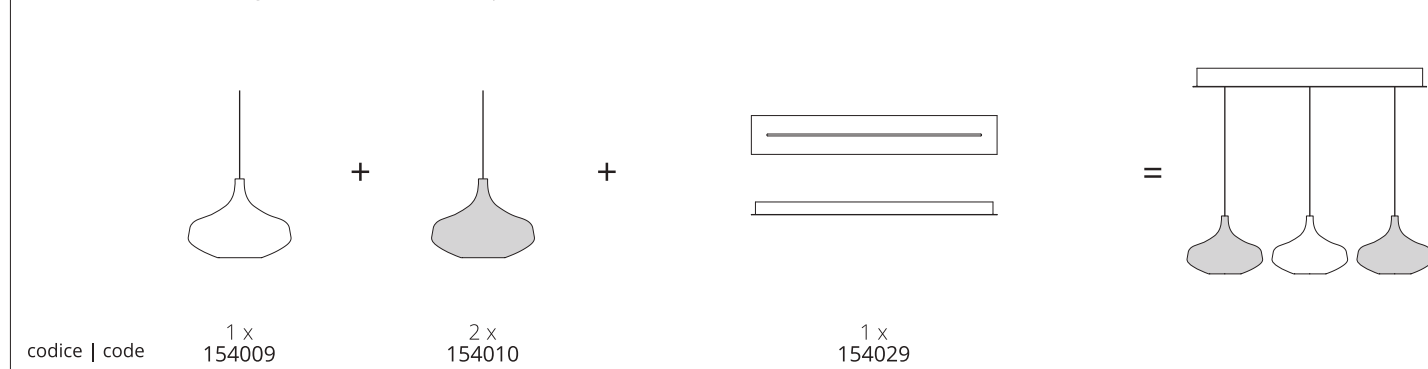

Note | Notes:

NOSTALGIA

MODELLO | MODEL LAMPADINA | LAMP MONTATURA | FRAME DIFFUSORE | DIFFUSER CODICE | CODE

Nostalgia Glass Small Pendant | Sospensione

	<p>LED</p> <p>2700K 9W 900 lm 210-250V CRI 92 MacAdam 3-Step</p>	<p>LED included</p>	<p>Metallo Metal</p>	<p>○ Cristallo Crystal</p>	154001
				<p>○ Cromo Chrome</p>	154002
				<p>● Oro Gold</p>	154003
				<p>● Oro Rosa Rose Gold</p>	154004
<p>CE ip40 Energy saving DIM TRIAC PG</p>		<p>Peso netto: 0.66 Kg Net Weight:</p>	<p>Confezione Packaging</p>	<p>Peso Lordo: 1.56 Kg Gross Weight:</p>	<p>n. Colli: 2 n. Pack: 2</p>
				<p>Vetro Glass</p>	<p>Volume m³: 0.02 Volume m³:</p>

Nostalgia Glass Medium Pendant | Sospensione

	<p>LED</p> <p>2700K 9W 900 lm 210-250V CRI 92 MacAdam 3-Step</p>	<p>LED included</p>	<p>Metallo Metal</p>	<p>○ Cristallo Crystal</p>	154005
				<p>○ Cromo Chrome</p>	154006
				<p>● Oro Gold</p>	154007
				<p>● Oro Rosa Rose Gold</p>	154008
<p>CE ip40 Energy saving DIM TRIAC PG</p>		<p>Peso netto: 0.75 Kg Net Weight:</p>	<p>Confezione Packaging</p>	<p>Peso Lordo: 1.81 Kg Gross Weight:</p>	<p>n. Colli: 2 n. Pack: 2</p>
				<p>Vetro Glass</p>	<p>Volume m³: 0.027 Volume m³:</p>

Nostalgia Glass Large Pendant | Sospensione

	<p>LED</p> <p>2700K 9W 900 lm 210-250V CRI 92 MacAdam 3-Step</p>	<p>LED included</p>	<p>Metallo Metal</p>	<p>○ Cristallo Crystal</p>	154009
				<p>○ Cromo Chrome</p>	154010
				<p>● Oro Gold</p>	154011
				<p>● Oro Rosa Rose Gold</p>	154012
<p>CE ip40 Energy saving DIM TRIAC PG</p>		<p>Peso netto: 1.02 Kg Net Weight:</p>	<p>Confezione Packaging</p>	<p>Peso Lordo: 2.9 Kg Gross Weight:</p>	<p>n. Colli: 2 n. Pack: 2</p>
				<p>Vetro Glass</p>	<p>Volume m³: 0.035 Volume m³:</p>

Le sospensioni devono essere installate sui **rosoni** presenti alle pagine 360 - 365
 The pendants must be installed with one of the **canopy** options listed on page 360 - 365
 Les suspensions doivent être installées sur les **patères** présentées dans les pages 360 - 365
 Die Hängeleuchten sollen auf die **Rosetten** auf Seiten 360 - 365 montiert werden
 Las lámparas de suspensión se deben instalar en los **rosetones** a pagina 360 - 365

Note | Notes: LED con alimentazione diretta a tensione di rete (non necessita di driver LED). Dimmerabile con varialuce a taglio di fase.
 LED with direct power supply to the AC line voltage (LED driver not required). Dimmable with phase cut dimming.

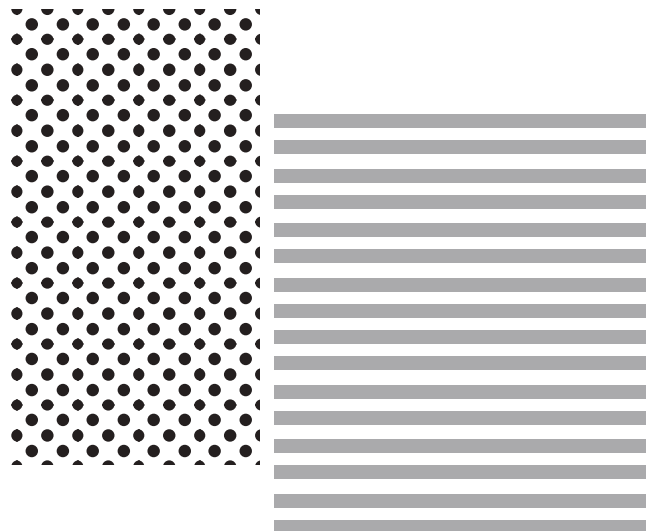

RANDOM

design: Chia-Ying Lee 2017

RANDOM IS A MAGIC SUSPENSION WHICH CONSISTS OF THREE SPHERICAL BLOWN GLASS DIFFUSERS, WHICH FORM A LIVELY AND SEEMINGLY RANDOMLY ACHIEVED ENTITY. EACH GLASS DIFFUSER IS EQUIPPED WITH AN EMBEDDED LED LIGHT SOURCE, WHICH PROVIDES WARM WHITE LIGHT. THE THREE GLASS SPHERES FORMING THE LIGHT ARE OF DIFFERENT SIZES AND EACH SUSPEND FROM A THIN CABLE. THE DIFFERENT SIZES, THE SUSPENSION'S HEIGHTS AND THE WAY THAT THE SPHERES CLING TO EACH OTHER CONFER RANDOM A LIVELY RANDOM CHARACTER. THE MODULARITY OF THE RANGE ALLOWS YOU TO CREATE AN INFINITE VARIETY OF CLUSTERS.

VETRO SOFFIATO FUSO IN UN DESIGN NON CONVENZIONALE, CREANDO LUMINOSITÀ UNICHE ED EMOZIONALI GRAZIE ALLA PREZIOSITÀ DEI DETTAGLI E DEI MATERIALI. LA SUA MODULARITÀ PERMETTE DI RICREARE COMPOSIZIONI SEMPRE NUOVE.







RANDOM
STUDIO
ITALIA
DESIGN





THE
LIGHTING
MAKERS
2018



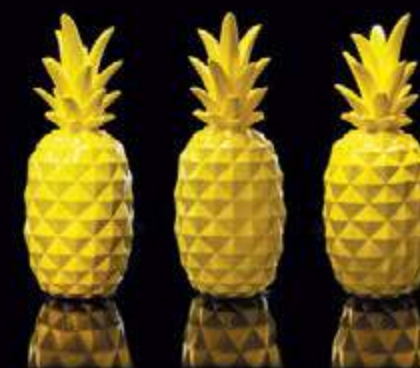

RANDOM
STUDIO
ITALIA
DESIGN





RANDOM
STUDIO
ITALIA
DESIGN



RANDOM composition

Random example of composition

[Ex: 1] Single Mini Suspensions | Sospensione Singola Mini

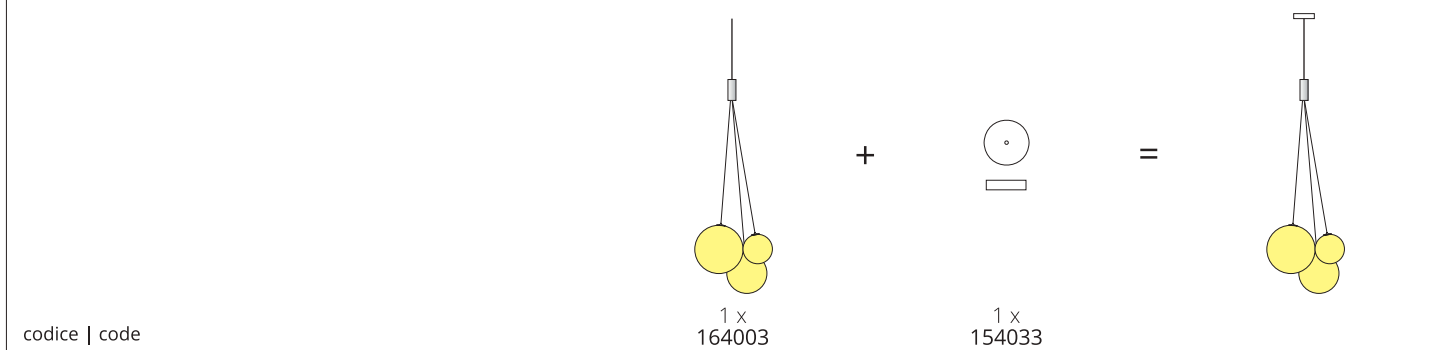

[Ex: 2] Cluster 3 Lights Composition | Composizione 3 Luci

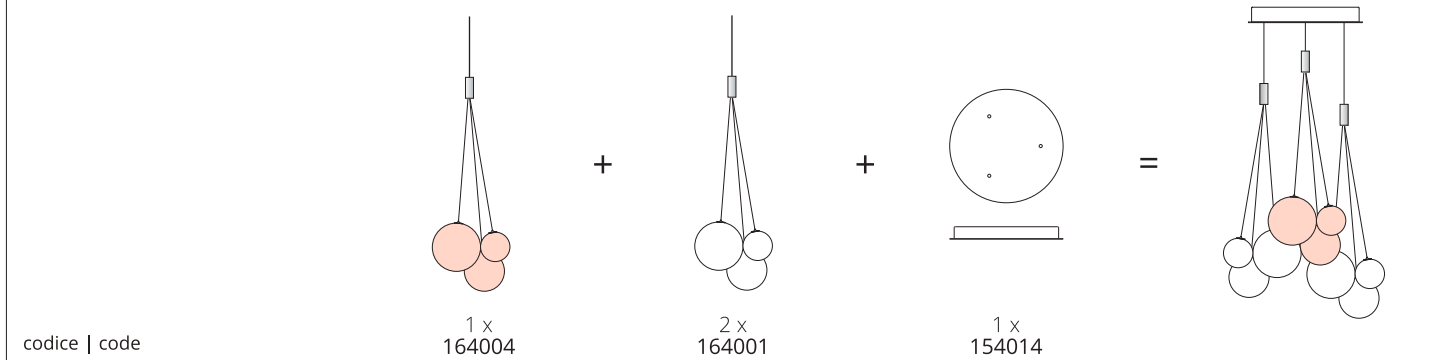

[Ex: 3] Recessed Lights Composition | Composizione Lampade Incassate

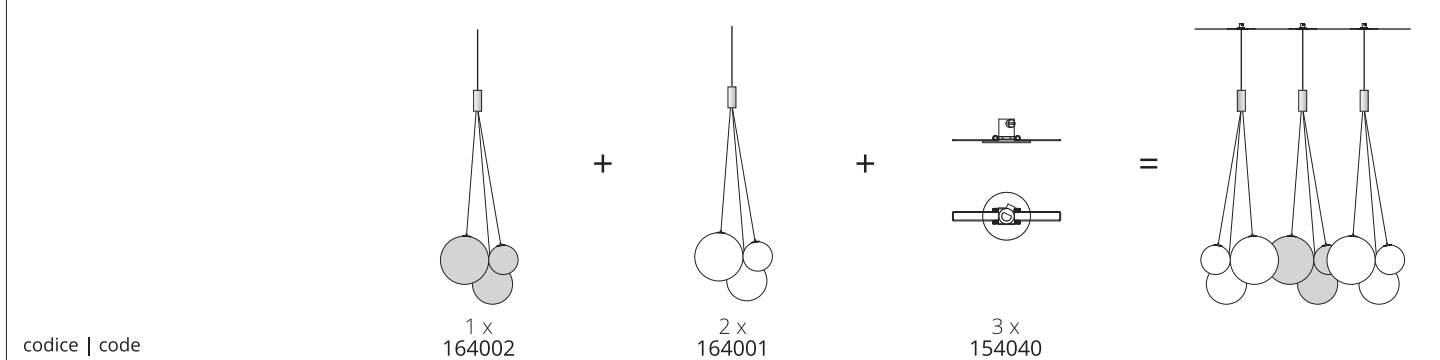

[Ex: 4] Cluster Rectangular 7 Lights Composition | Composizione 7 Rettangolare Luci

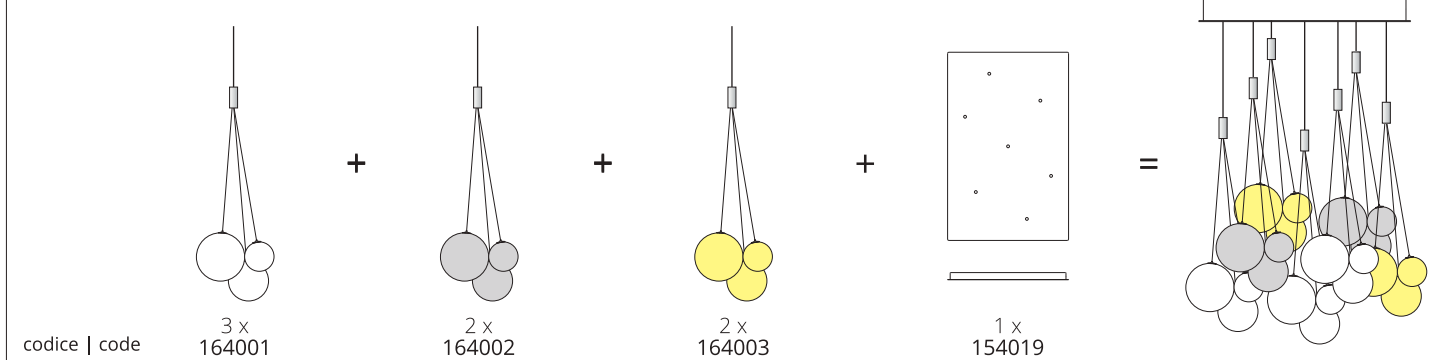

Note | Notes:

RANDOM

MODELLO | MODEL

LAMPADINA | LAMP

MONTATURA | FRAME

DIFFUSORE | DIFFUSER

CODICE | CODE

Random Pendant | Sospensione

	<p>LED</p> <p>2700K 3 x 1W 450 lm 350mA CRI 90 MacAdam 3-Step</p> <p>LED and DRIVER included</p>	<p>metallo Metal</p> <p>chromo Chrome</p>	<p>crystallo Crystal</p> <p>chromo Chrome</p> <p>oro Gold</p> <p>oro rosa Rose Gold</p> <p>vetro soffiato Blown Glass</p>	<p>164001</p> <p>164002</p> <p>164003</p> <p>164004</p>
<p>CE ip20 energy saving DIM TRIAC PG</p>		<p>Peso netto: 1.0 Kg Net Weight:</p>	<p>Confezione Packaging</p> <p>Peso Lordo: 1.98 Kg Gross Weight:</p>	<p>n. Colli: 2 n. Pack:</p> <p>Volume m³: 0.04 Volume m³:</p>

Le sospensioni devono essere installate sui **rosoni** presenti alle pagine 360 - 365
 The pendants must be installed with one of the **canopy** options listed on page 360 - 365
 Les suspensions doivent être installées sur les **patères** présentées dans les pages 360 - 365
 Die Hängeleuchten sollen auf die **Rosetten** auf Seiten 360 - 365 montiert werden
 Las lámparas de suspensión se deben instalar en los **rósetones** a pagina 360 - 365

Note | Notes:

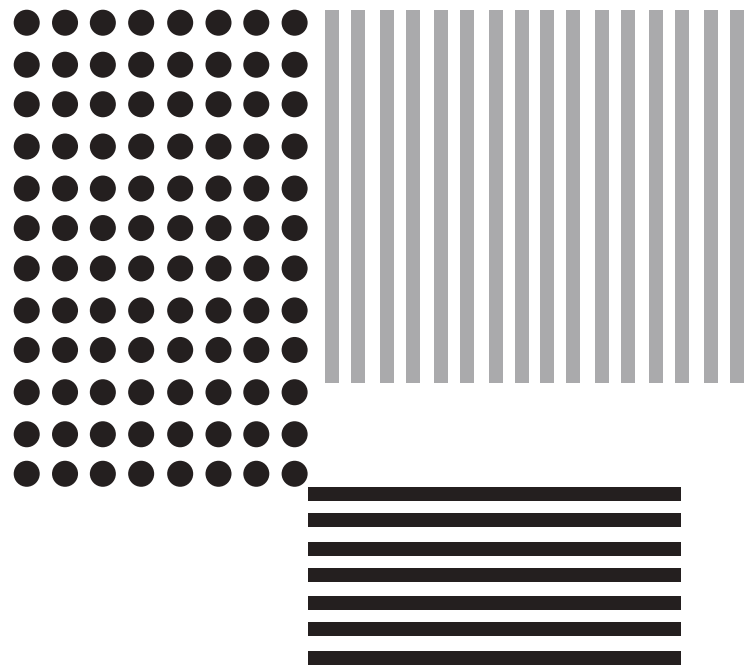

BLOW

design: Pio e Tito Toso 2005

TABLE OR FLOOR LUMINAIRE FOR DIRECT ILLUMINATION. THIS MAGICAL AND ETHEREAL “BLOW” SOAP BUBBLE ALLOWS THE LIGHT TO “BREATH” THROUGH A BLOWN GLASS DIFFUSER CREATING WONDERFUL EFFECTS. . FRAME IN CHROMED METAL WITH BRUSHED ALUMINUM ACCENT PIECES. THE LIGHT SOURCE CAN BE DIRECTED FROM THE OUTSIDE THROUGH A MAGNET PLACED ON TOP OF THE DIFFUSER.

UNA BOLLA DI SAPONE MAGICA E LEGGERA GRAZIE ALLA TRASPARENZA DEL VETRO SOFFIATO PERMETTENDO ALLA LUCE AL SUO INTERNO DI RESPIRARE E ILLUMINARE L'AMBIENTE CREANDO MERAVIGLIOSI FASCI DI LUCE.





BLOW

MODELLO | MODEL LAMPADINA | LAMP MONTATURA | FRAME DIFFUSORE | DIFFUSER CODICE | CODE

Blow Led Table | Tavolo

<p>Ø cm 26 10.23"</p> <p>cm 41 16.14"</p> <p>Ø cm 10 3.93"</p>	<p>LED</p> <p>2700K 4.5W 500 lm 500 mA CRI 90 MacAdam 3-Step</p> <p>LED and DRIVER included</p>	<p>● Cromo Chrome</p> <p>Metallo Metal</p>	<p>● Cristallo Crystal</p> <p>Vetro Soffiato Blown Glass</p>	<p>008004</p>
<p>CE ip40 energy saving PG</p>	<p>Peso netto: Net Weight: 4 Kg</p>	<p>Confezione Packaging</p>	<p>Peso Lordo: Gross Weight: 5.81 Kg</p>	<p>n. Colli: n. Pack: 1</p> <p>Volume m³: Volume m³: 0.113</p>

Note | Notes:

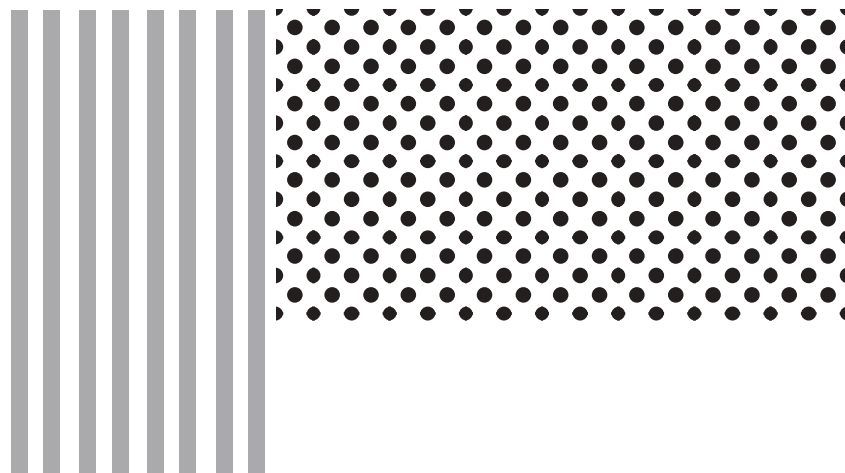

MAKE-UP

design: Studio Italia Design 2015

THE MAKE-UP WALL/CEILING FIXTURE WAS DESIGNED TO “MAKE UP” WALLS OR CEILINGS IN AN VERSATILE WAY TO CREATE COMPOSITIONS THAT ARE EASILY ADAPTED TO THEIR OWN SPACES. ONE CAN DESIGN ALMOST ENDLESS COMPOSITIONS THANKS TO THE ASSEMBLY MADE IN SUCH A WAY AS TO ALLOW UP TO 50 LIGHTS CONNECTED TO ONE ANOTHER WITHOUT VISIBLE CORDS TO A SINGLE J-BOX. EACH LED LIGHT IS COMPOSED OF A METAL WHITE STRUCTURE AND THE DIFFUSER ALLOWS A UNIFORM REFINED LIGHT.

INSPIRATE AL MONDO DEL MAKE-UP DELL'ALTA MODA QUESTE LAMPADRE COMPONIBILI E MODULARI IN VETRO SOFFIATO CHE RACCHIUDONO UN CUORE A LED TRASPORTANO LA LUCE CREANDO INFINITE COMPOSIZIONI.



MAKE-UP
STUDIO
ITALIA
DESIGN





MAKEUP

MODELLO | MODEL LAMPADINA | LAMP MONTATURA | FRAME DIFFUSORE | DIFFUSER CODICE | CODE

Makeup Small Wall & Ceiling | Parete & Plafoniera

	<p>LED</p> <p>3000K 9W 950 lm 210-250V CRI 92 MacAdam 3-Step</p>	<p>● Bianco Opaco 9016 Matte White 9016</p>	<p>● Bianco latte satinato Matte Milk White</p>	<p>150003</p>		
<p>LED included</p>		<p>Metallo Metal</p>	<p>Vetro Glass</p>			
<p>CE </p>		<p>Peso netto: 1.3 Kg Net Weight:</p>	<p>Confezione Packaging</p>	<p>Peso Lordo: 1.89 Kg Gross Weight:</p>	<p>n. Colli: 1 n. Pack:</p>	<p>Volume m³: 0.026 Volume m³:</p>

Makeup Medium Wall & Ceiling | Parete & Plafoniera

	<p>LED</p> <p>3000K 17W 1800 lm 210-250V CRI 92 MacAdam 3-Step</p>	<p>● Bianco Opaco 9016 Matte White 9016</p>	<p>● Bianco latte satinato Matte Milk White</p>	<p>150002</p>		
<p>LED included</p>		<p>Metallo Metal</p>	<p>Vetro Glass</p>			
<p>CE </p>		<p>Peso netto: 2.32 Kg Net Weight:</p>	<p>Confezione Packaging</p>	<p>Peso Lordo: 2.89 Kg Gross Weight:</p>	<p>n. Colli: 1 n. Pack:</p>	<p>Volume m³: 0.026 Volume m³:</p>

Makeup Large Wall & Ceiling | Parete & Plafoniera

	<p>LED</p> <p>3000K 17W 1800 lm 210-250V CRI 92 MacAdam 3-Step</p>	<p>● Bianco Opaco 9016 Matte White 9016</p>	<p>● Bianco latte satinato Matte Milk White</p>	<p>150001</p>		
<p>LED included</p>		<p>Metallo Metal</p>	<p>Vetro Glass</p>			
<p>CE </p>		<p>Peso netto: 3.88 Kg Net Weight:</p>	<p>Confezione Packaging</p>	<p>Peso Lordo: 5.04 Kg Gross Weight:</p>	<p>n. Colli: 1 n. Pack:</p>	<p>Volume m³: 0.057 Volume m³:</p>

Note | Notes: LED con alimentazione diretta a tensione di rete (non necessita di driver LED). Dimmerabile con varialuce a taglio di fase.
LED with direct power supply to the AC line voltage (LED driver not required). Dimmable with phase cut dimming.

Le lampade sono collegabili tra di loro fino ad un massimo di 50 apparecchi per ogni singolo punto di alimentazione elettrica.
Lamps can be daisy chained up to a maximum of 50 devices for each point of power supply.

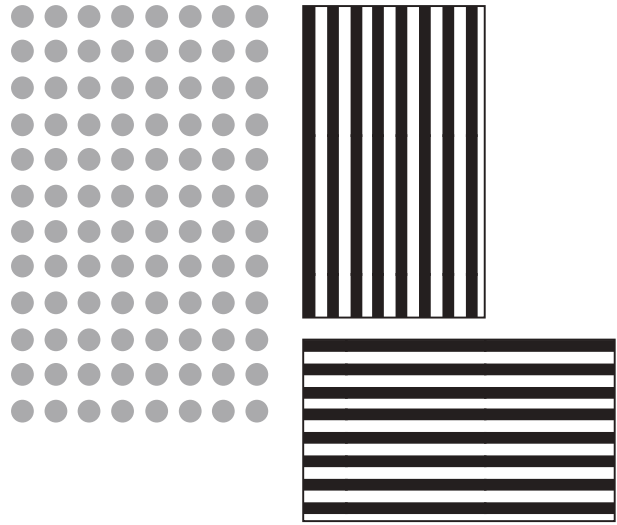

BEETLE

design: Studio Italia Design 2014

THE BEETLE WALL AND CEILING LIGHT IS SIMPLE, MODERN, AND GEOMETRIC. WITH A WHITE DIFFUSER IN FRONT AND CLEAR RIBBED SIDES, THE LIGHT CAN EXUDE FROM EVERY ANGLE OF THIS FIXTURE, WASHING ONTO THE WALL AND INTO YOUR SPACE. USE ALONE OR PAIR WITH OTHER BEETLE FIXTURES FOR VARIATION IN SIZE AND SHAPE. A SLIM WHITE METAL FRAME HOLDS THE POLYCARBONATE SIDES TOGETHER. FEATURES ECO-FRIENDLY LED LIGHTS. DIMMABLE WITH A PHASE CUT DIMMER.

UNA SINTESI GEOMETRICA TRA MATERIALI DUREVOLI E SORGENTI LUMINOSE MODERNE. RACCHIUDE IN SÉ LA LUCE ALLO STATO PURO E LA DIFFONDE IN OGNI AMBIENTE.



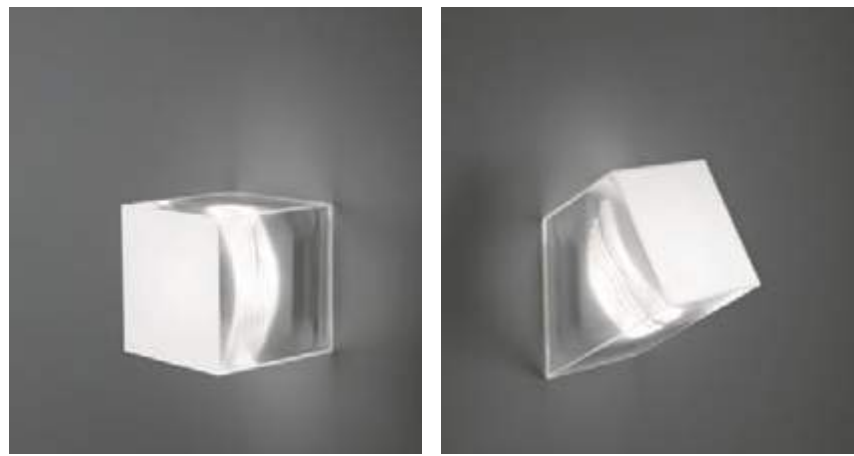

BEETLE









BEETLE

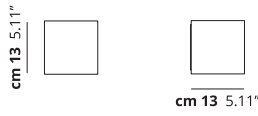

BEETLE

MODELLO | MODEL LAMPADINA | LAMP MONTATURA | FRAME DIFFUSORE | DIFFUSER CODICE | CODE

Beetle Mini Cube Wall & Ceiling | Parete & Plafoniera

	3000K 17W 1800 lm LED 210-250V CRI 92 MacAdam 3-Step	 Bianco Opaco 9016 Matte White 9016	 Bianco + Trasparente Rigato White + Clear Ribbed	145001		
			 Bianco White	145009		
LED included		Metallo Metal	Policarbonato Polycarbonate			
CE    		Peso netto: 0.64 Kg Net Weight:	Confezione Packaging	Peso Lordo: 1.1 Kg Gross Weight:	n. Colli: 2 n. Pack:	Volume m³: 0.009 Volume m³:







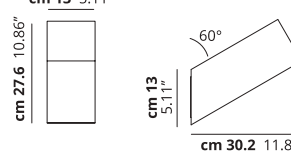

Beetle Medium Cube Wall & Ceiling | Parete & Plafoniera

	3000K 17W 1800 lm LED 210-250V CRI 92 MacAdam 3-Step	 Bianco Opaco 9016 Matte White 9016	 Bianco + Trasparente Rigato White + Clear Ribbed	145002		
			 Bianco White			
LED included		Metallo Metal	Policarbonato Polycarbonate			
CE    		Peso netto: 0.67 Kg Net Weight:	Confezione Packaging	Peso Lordo: 1.6 Kg Gross Weight:	n. Colli: 2 n. Pack:	Volume m³: 0.017 Volume m³:

Beetle Mini 60° Cube Wall & Ceiling | Parete & Plafoniera

	3000K 17W 1800 lm LED 210-250V CRI 92 MacAdam 3-Step	 Bianco Opaco 9016 Matte White 9016	 Bianco + Trasparente Rigato White + Clear Ribbed	145003		
			 Bianco White			
LED included		Metallo Metal	Policarbonato Polycarbonate			
CE    		Peso netto: 0.88 Kg Net Weight:	Confezione Packaging	Peso Lordo: 1 Kg Gross Weight:	n. Colli: 2 n. Pack:	Volume m³: 0.009 Volume m³:

Beetle Medium 60° Cube Wall & Ceiling | Parete & Plafoniera

	3000K 17W 1800 lm LED 210-250V CRI 92 MacAdam 3-Step	 Bianco Opaco 9016 Matte White 9016	 Bianco + Trasparente Rigato White + Clear Ribbed	145004		
			 Bianco White			
LED included		Metallo Metal	Policarbonato Polycarbonate			
CE    		Peso netto: 0.97 Kg Net Weight:	Confezione Packaging	Peso Lordo: 1.48 Kg Gross Weight:	n. Colli: 2 n. Pack:	Volume m³: 0.020 Volume m³:

Beetle Small Pyramid Wall & Ceiling | Parete & Plafoniera

	3000K 17W 1800 lm LED 210-250V CRI 92 MacAdam 3-Step	 Bianco Opaco 9016 Matte White 9016	 Bianco + Trasparente Rigato White + Clear Ribbed	145005		
			 Bianco White			
LED included		Metallo Metal	Policarbonato Polycarbonate			
CE    		Peso netto: 1.17 Kg Net Weight:	Confezione Packaging	Peso Lordo: 2.5 Kg Gross Weight:	n. Colli: 2 n. Pack:	Volume m³: 0.027 Volume m³:

Note | Notes: LED con alimentazione diretta a tensione di rete (non necessita di driver LED). Dimmerabile con varialuce a taglio di fase.
 LED with direct power supply to the AC line voltage (LED driver not required). Dimmable with phase cut dimming.

BEETLE

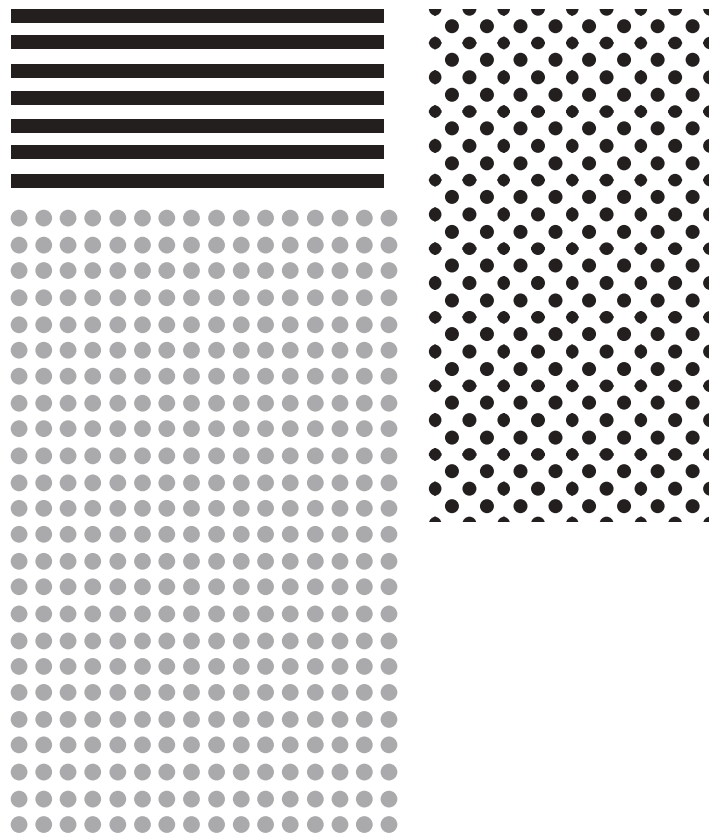

MILLO

design: Marta Sansoni 2016

DEFINED BY ITS ORGANIC SHAPE AND CRISP WHITE COLOR, THE MILLO WALL/CEILING IS A VERSATILE LIGHT FIXTURE THAT ADDS A UNIQUE DESIGN DETAIL TO ANY SPACE. THE FRAME OF THIS MODERN LAMP IS MADE FROM METAL THAT IS FORMED AND MOLDED TO CREATE EGG-LIKE SHAPE. SURROUNDING THE FRAME IS THE WHITE FABRIC SHADE WHICH CONCEALS THE LIGHT SOURCES. WHEN ILLUMINATED, THIS DECORATIVE LIGHT PROVIDES DIFFUSED, AMBIENT LIGHT THAT IS PERFECT FOR ILLUMINATING BOTH RESIDENTIAL AND COMMERCIAL SETTINGS. AVAILABLE IN THREE SIZES, THE MILLO CAN BE USED AS A SOLO FIXTURE OR ARRANGED IN A GROUPING TO CREATE A DYNAMIC INSTALLATION ON THE WALL OR CEILING.

E' UNA LAMPADA DI GRANDI DIMENSIONI IN TESSUTO DALLE FORME MORBIDE ED ORGANICHE CHE DIFFONDE LA LUCE DALLE NOSTRE PARETI E SOFFITTI, UN OGGETTO D'ARREDO CHE RENDE L'AMBIENTE ESCLUSIVO.











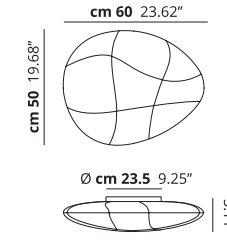

MILLO

MODELLO | MODEL LAMPADINA | LAMP MONTATURA | FRAME DIFFUSORE | DIFFUSER CODICE | CODE



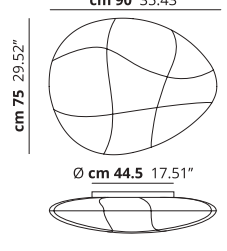

Millo Small Wall & Ceiling | Parete & Plafoniera

	<p>E27 CFL 2 x max 30W</p> <p>OR</p> <p>E27 LED 2 x max available</p> <p>Lampadine non incluse Bulbs not included</p>	<p>Bianco Opaco 9010 Matte White 9010</p>	<p>Bianco White</p>	<p>157001</p>
<p>CE    </p>		<p>Peso netto: 1.1 Kg Net Weight:</p>	<p>Confezione Packaging</p>	<p>Peso Lordo: 1.73 Kg Gross Weight: n. Colli: 1 n. Pack: Volume m³: 0.031</p>

Millo Medium Wall & Ceiling | Parete & Plafoniera

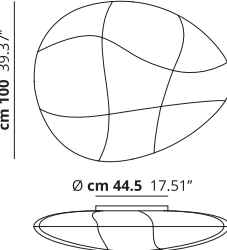
	<p>E27 CFL 4 x max 30W</p> <p>OR</p> <p>E27 LED 4 x max available</p> <p>Lampadine non incluse Bulbs not included</p>	<p>Bianco Opaco 9010 Matte White 9010</p>	<p>Bianco White</p>	<p>157002</p>
<p>CE    </p>		<p>Peso netto: 2.25 Kg Net Weight:</p>	<p>Confezione Packaging</p>	<p>Peso Lordo: 5.41 Kg Gross Weight: n. Colli: 1 n. Pack: Volume m³: 0.122</p>

Millo Large Wall & Ceiling | Parete & Plafoniera

	<p>E27 CFL 4 x max 30W</p> <p>OR</p> <p>E27 LED 4 x max available</p> <p>Lampadine non incluse Bulbs not included</p>	<p>Bianco Opaco 9010 Matte White 9010</p>	<p>Bianco White</p>	<p>157003</p>
<p>CE    </p>		<p>Peso netto: 2.7 Kg Net Weight:</p>	<p>Confezione Packaging</p>	<p>Peso Lordo: 7.49 Kg Gross Weight: n. Colli: 1 n. Pack: Volume m³: 0.22</p>

Note | Notes:

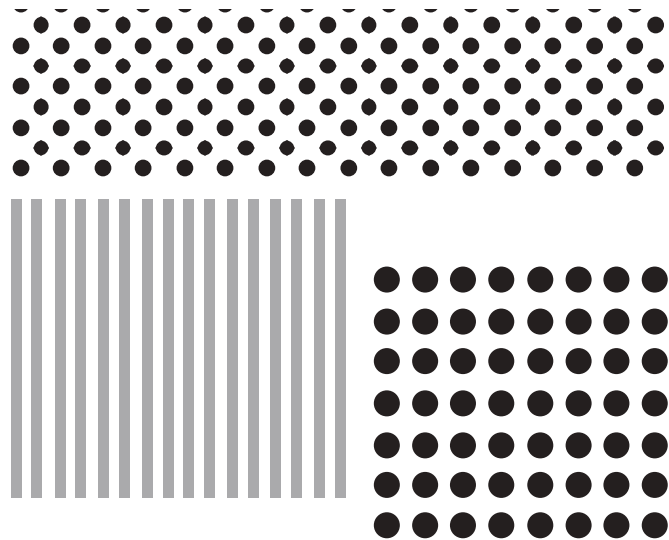

VAPOR

design: Karim Rashid 2012

A PLAYFUL FLOURISH CAPTURES THE SPIRIT OF THE VAPOR FLOOR LAMP, A TALL AND CURVACEOUS FIXTURE ACTUALIZED BY FAMED DESIGNER KARIM RASHID. THE SOFT UNDULATING LINES CARRY OUT THE WARM DIFFUSED LIGHT, CREATING NATURAL SHADOWS THROUGH THE PLEATED AND RIPPLING PROFILE. FOUR STACKED WHITE ACRYLIC DIFFUSERS MAKE UP THE TOWERING FIXTURE, SIMULATING A FIGURATIVE FORM THAT IS PLEASING TO THE EYE. THE SHEER MAGNITUDE AND STURDINESS OF THE MATERIAL MAKES THE VAPOR A FINE COMPANION TO LIVING SPACES THAT DEMAND COMFORTING LIGHT AND SHARP DESIGN SENSIBILITIES. THE SIZE AND QUALITY MATERIALS USED IN THE VAPOR COLLECTION MAKES THIS FLOOR LAMP A MASTER PIECE OF MODERN DESIGN. THE LIGHT SOURCE CAN BE REGULATED BY AN INTEGRAL DIMMER.

SINUOSA COME UN CORPO FEMMINILE COMPOSTA DAL SUO DIFFUSORE IN POLICARBONATO AD ONDE, È UN ELEMENTO IRRINUNCIABILE PER TUTTI GLI AMBIENTI DOVE È RICERCATO UN DESIGN ESCLUSIVO.



VAPOR STUDIO ITALIA DESIGN



THE
LIGHTING
MAKERS
2018

356

VAPOR

MODELLO | MODEL





LAMPADINA | LAMP

MONTATURA | FRAME

DIFFUSORE | DIFFUSER

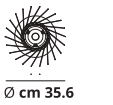
CODICE | CODE

Vapor Floor | Terra

 <p>cm 196 77,16"</p> <p>Ø cm 35,6 14,01"</p>  <p>Ø cm 35,6 14,01"</p>	<p>R7s QT-DE12 short 1x max 80W eco</p> <p>AND _____</p> <p>E27 Classic A60 6x max 77W eco</p> <p>OR _____</p> <p>E27 CFL 6x max 30W</p> <p>OR _____</p> <p>E27 LED 6x max available</p> <p>Lampadine non incluse Bulbs not included</p>	<p>Bianco Opaco 9010 Matte White 9010</p>	<p>Bianco Opaco 9010 Matte White 9010</p>	<p>129009</p>
<p>CE  Energy saving   DIMMER included</p>		<p>Peso netto: 24 Kg Net Weight:</p>	<p>Confezione Packaging</p>	<p>Peso Lordo: 32.55 Kg Gross Weight: n. Colli: 2 n. Pack: Volume m³: 0.414</p>





Note | Notes:

COMPO- SITIONS

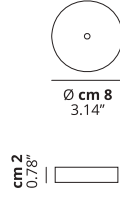

SINGLE system

MODELLO | MODEL INFO | INFO COLORE | COLOR SISTEMA | SYSTEM CODICE | CODE

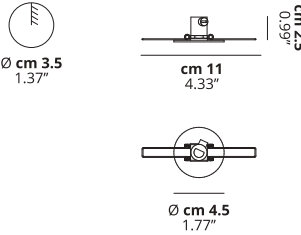

Single Mini Canopy | Rosone

	<p>Rosone per lampada singola dimensioni ridotte</p> <p>Single ceiling bracket small size</p>	 Bianco Opaco 9010 Matte White 9010	Single	154033
		 Nero Opaco Matte Black		154034
		 Bronzo Ramato Coppery Bronze		154035
		 Cromo Chrome		154036
<p>Peso netto: 0.2 Kg Confezione Packaging Peso Lordo: 0.3 Kg n. Colli: 1 Volume m³: 0.002</p> <p>Net Weight: 0.2 Kg Gross Weight: 0.3 Kg n. Pack: 1 Volume m³: 0.002</p>				

Recessed Micro Canopy | Rosone

	<p>Rosone da incasso per lampada singola</p> <p>Recessed bracket for single lamp</p>	 Bianco Opaco 9010 Matte White 9010	Recessed system	154037		
		 Cromo Chrome		154040		
		<p>Peso netto: 0.032 Kg Confezione Packaging Peso Lordo: 0.2 Kg n. Colli: 1 Volume m³: 0.002</p> <p>Net Weight: 0.032 Kg Gross Weight: 0.2 Kg n. Pack: 1 Volume m³: 0.002</p>				

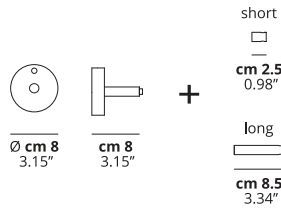
Wall Standard Wall Bracket | Rosone Parete

	<p>Rosone a parete per sospensioni sistema componibile</p> <p>Wall bracket for pendant suspension modular system</p>	 Cromo Chrome	Wall system	154038		
		<p>Peso netto: 0.8 Kg Confezione Packaging Peso Lordo: 1.1 Kg n. Colli: 1 Volume m³: 0.002</p> <p>Net Weight: 0.8 Kg Gross Weight: 1.1 Kg n. Pack: 1 Volume m³: 0.002</p>				

Single Standard Canopy | Rosone



	<p>Rosone per lampada singola versione standard</p> <p>Single ceiling bracket standard size</p>	 Bianco Opaco 9010 Matte White 9010	Single	154013		
		<p>Peso netto: 0.4 Kg Confezione Packaging Peso Lordo: 0.48 Kg n. Colli: 1 Volume m³: 0.002</p> <p>Net Weight: 0.4 Kg Gross Weight: 0.48 Kg n. Pack: 1 Volume m³: 0.002</p>				

Note | Notes: **Wall Standard** - Entrambi gli accessori nelle due diverse lunghezze sono inclusi nella confezione con il supporto a parete.
Wall Standard - Both accessories in the two available lengths are supplied in the box with the wall bracket.

TRACK system

MODELLO | MODEL INFO | INFO COLORE | COLOR SISTEMA | SYSTEM CODICE | CODE

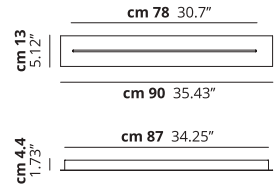

Linear Track Short Track | Binario

	<p>Binario lineare multiplo modello standard massimo 7 sospensioni</p> <p>Multiple linear track standard version max 7 suspensions</p>	 Bianco Opaco 9010 Matte White 9010	Track system	154029		
		<p>Peso netto: 5.5 Kg Confezione Packaging Peso Lordo: 6.37 Kg n. Colli: 1 Volume m³: 0.019</p> <p>Net Weight: 5.5 Kg Gross Weight: 6.37 Kg n. Pack: 1 Volume m³: 0.019</p>				

Track System List Short Maximum Quantity | Quantità Installabili

pendenti allineati pendants aligned	pendenti sfalsati staggered pendants
in line TTTT	up&down TTTT
max 7 mod. A-Tube max 7 mod. A-Tube Nano max 7 mod. A-Tube Nano Duo max 4 mod. Kelly Cluster max 7 mod. Nostalgia Small max 4 mod. Nostalgia Medium max 3 mod. Nostalgia Large max 7 mod. Rain max 3 mod. Random max 7 mod. Spider max 7 mod. Valentina	max 7 mod. A-Tube max 7 mod. A-Tube Nano max 7 mod. A-Tube Nano Duo max 7 mod. Kelly Cluster max 7 mod. Nostalgia Small max 7 mod. Nostalgia Medium max 5 mod. Nostalgia Large max 7 mod. Rain max 5 mod. Random max 7 mod. Spider max 7 mod. Valentina

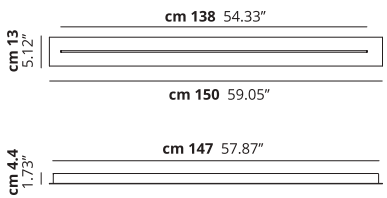
Linear Track Long Track | Binario

	<p>Binario lineare multiplo modello standard massimo 11 sospensioni</p> <p>Multiple linear track standard version max 11 suspensions</p>	 Bianco Opaco 9010 Matte White 9010	Track system	154030		
		<p>Peso netto: 8.8 Kg Confezione Packaging Peso Lordo: 10.15 Kg n. Colli: 1 Volume m³: 0.031</p> <p>Net Weight: 8.8 Kg Gross Weight: 10.15 Kg n. Pack: 1 Volume m³: 0.031</p>				

Track System List Long Maximum Quantity | Quantità Installabili

pendenti allineati pendants aligned	pendenti sfalsati staggered pendants
in line TTTT	up&down TTTT
max 11 mod. A-Tube max 11 mod. A-Tube Nano max 11 mod. A-Tube Nano Duo max 8 mod. Kelly Cluster max 11 mod. Nostalgia Small max 7 mod. Nostalgia Medium max 5 mod. Nostalgia Large max 11 mod. Rain max 5 mod. Random max 11 mod. Spider max 11 mod. Valentina	max 11 mod. A-Tube max 11 mod. A-Tube Nano max 11 mod. A-Tube Nano Duo max 11 mod. Kelly Cluster max 11 mod. Nostalgia Small max 11 mod. Nostalgia Medium max 9 mod. Nostalgia Large max 11 mod. Rain max 9 mod. Random max 11 mod. Spider max 11 mod. Valentina

Note | Notes: Le sospensioni **Sky-Fall** non possono essere installate su questi binari. Vedere alla pagina 23
The **Sky-Fall** suspensions can not be installed on this track light. Shown page 23

CLUSTER system

MODELLO | MODEL INFO | INFO COLORE | COLOR SISTEMA | SYSTEM CODICE | CODE



Cluster 3 Lights Round Cluster Canopy | Rosone Cluster

	<p>Rosone circolare per 3 sospensioni Ceiling bracket for 3 suspensions</p>	<p>Bianco Opaco 9010 Matte White 9010</p>	<p>Cluster system</p>	<p>154014</p>
<p>CE </p>		<p>Peso netto: 3.55 Kg Net Weight:</p>	<p>Confezione Packaging</p>	<p>Peso Lordo: 4.3 Kg Gross Weight: n. Colli: 1 n. Pack: Volume m³: 0.025 Volume m³:</p>

Cluster 5 Lights Round Cluster Canopy | Rosone Cluster

	<p>Rosone circolare per 5 sospensioni Ceiling bracket for 5 suspensions</p>	<p>Bianco Opaco 9010 Matte White 9010</p>	<p>Cluster system</p>	<p>154015</p>
<p>CE </p>		<p>Peso netto: 3.55 Kg Net Weight:</p>	<p>Confezione Packaging</p>	<p>Peso Lordo: 4.3 Kg Gross Weight: n. Colli: 1 n. Pack: Volume m³: 0.025 Volume m³:</p>

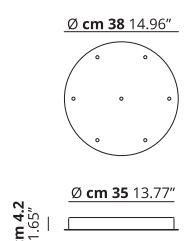
Cluster 7 Lights Round Cluster Canopy | Rosone Cluster



	<p>Rosone circolare per 7 sospensioni Ceiling bracket for 7 suspensions</p>	<p>Bianco Opaco 9010 Matte White 9010</p>	<p>Cluster system</p>	<p>154016</p>
<p>CE </p>		<p>Peso netto: 3.55 Kg Net Weight:</p>	<p>Confezione Packaging</p>	<p>Peso Lordo: 4.3 Kg Gross Weight: n. Colli: 1 n. Pack: Volume m³: 0.025 Volume m³:</p>

Note | Notes:

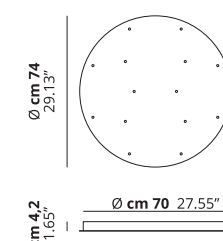

CLUSTER system

MODELLO | MODEL INFO | INFO COLORE | COLOR SISTEMA | SYSTEM CODICE | CODE

Cluster 14 Lights Round Cluster Canopy | Rosone Cluster

	<p>Rosone circolare per 14 sospensioni Ceiling bracket for 14 suspensions</p>	<p>Bianco Opaco 9010 Matte White 9010</p>	<p>Cluster system</p>	<p>154017</p>
<p>CE </p>		<p>Peso netto: 14.14 Kg Net Weight:</p>	<p>Confezione Packaging</p>	<p>Peso Lordo: 18.04 Kg Gross Weight: n. Colli: 1 n. Pack: Volume m³: 0.122 Volume m³:</p>

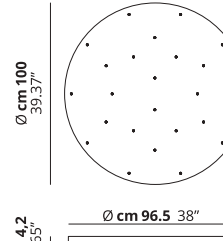
Cluster 24 Lights Round Cluster Canopy | Rosone Cluster

	<p>Rosone circolare per 24 sospensioni Ceiling bracket for 24 suspensions</p>	<p>Bianco Opaco 9010 Matte White 9010</p>	<p>Cluster system</p>	<p>154025</p>
<p>CE </p>		<p>Peso netto: 23.5 Kg Net Weight:</p>	<p>Confezione Packaging</p>	<p>Peso Lordo: 28.91 Kg Gross Weight: n. Colli: 1 n. Pack: Volume m³: 0.22 Volume m³:</p>

Cluster 36 Lights Round Cluster Canopy | Rosone Cluster

	<p>Rosone circolare per 36 sospensioni Ceiling bracket for 36 suspensions</p>	<p>Bianco Opaco 9010 Matte White 9010</p>	<p>Cluster system</p>	<p>154018</p>
<p>CE </p>		<p>Peso netto: 32.7 Kg Net Weight:</p>	<p>Confezione Packaging</p>	<p>Peso Lordo: 38.59 Kg Gross Weight: n. Colli: 1 n. Pack: Volume m³: 0.19 Volume m³:</p>

Note | Notes:

CLUSTER system

MODELLO | MODEL INFO | INFO COLORE | COLOR SISTEMA | SYSTEM CODICE | CODE

Cluster 7 Lights Rectangular Cluster Canopy | Rosone Cluster

	<p>Rosone rettangolare per 7 sospensioni Rectangular Canopy for 7 suspensions</p>	<p>Bianco Opaco 9010 Matte White 9010</p>	<p>Cluster system</p>	<p>154019</p>
<p>CE </p>		<p>Peso netto: 9.89 Kg Net Weight:</p>	<p>Confezione Packaging</p>	<p>Peso Lordo: 11.37 Kg Gross Weight:</p>
		<p>n. Colli: 1 n. Pack:</p>	<p>Volume m³: 0.052 Volume m³:</p>	

Cluster 14 Lights Rectangular Cluster Canopy | Rosone Cluster

	<p>Rosone rettangolare per 14 sospensioni Rectangular Canopy for 14 suspensions</p>	<p>Bianco Opaco 9010 Matte White 9010</p>	<p>Cluster system</p>	<p>154020</p>
<p>CE </p>		<p>Peso netto: 17.1 Kg Net Weight:</p>	<p>Confezione Packaging</p>	<p>Peso Lordo: 20.10 Kg Gross Weight:</p>
		<p>n. Colli: 1 n. Pack:</p>	<p>Volume m³: 0.098 Volume m³:</p>	

Cluster 28 Lights Rectangular Cluster Canopy | Rosone Cluster

	<p>Rosone rettangolare per 28 sospensioni Rectangular Canopy for 28 suspensions</p>	<p>Bianco Opaco 9010 Matte White 9010</p>	<p>Cluster system</p>	<p>154021</p>
<p>CE </p>		<p>Peso netto: 31.1 Kg Net Weight:</p>	<p>Confezione Packaging</p>	<p>Peso Lordo: 36.39 Kg Gross Weight:</p>
		<p>n. Colli: 1 n. Pack:</p>	<p>Volume m³: 0.165 Volume m³:</p>	

RADIAL system

MODELLO | MODEL INFO | INFO COLORE | COLOR SISTEMA | SYSTEM CODICE | CODE

Radial Single or Double Radial Canopy | Rosone a Raggiera

	<p>Rosone circolare per pendente singolo decentrato o doppi contrapposti Ceiling bracket single decentralized pendant or double opposed</p>	<p>Bianco Opaco 9010 Matte White 9010</p>	<p>Radial system</p>	<p>154026</p>
<p>CE </p>		<p>Peso netto: 0.35 Kg Net Weight:</p>	<p>Confezione Packaging</p>	<p>Peso Lordo: 0.41 Kg Gross Weight:</p>
		<p>n. Colli: 1 n. Pack:</p>	<p>Volume m³: 0.002 Volume m³:</p>	

Radial 4 Lights Round Radial Canopy | Rosone a Raggiera

	<p>Rosone circolare massimo 4 sospensioni a raggiera Ceiling bracket max 4 suspensions radially</p>	<p>Bianco Opaco 9010 Matte White 9010</p>	<p>Radial system</p>	<p>154041</p>
<p>CE </p>		<p>Peso netto: 0.35 Kg Net Weight:</p>	<p>Confezione Packaging</p>	<p>Peso Lordo: 0.41 Kg Gross Weight:</p>
		<p>n. Colli: 1 n. Pack:</p>	<p>Volume m³: 0.002 Volume m³:</p>	

Radial 12 Lights Round Radial Canopy | Rosone a Raggiera

	<p>Rosone circolare massimo 12 sospensioni a raggiera Ceiling bracket max 12 suspensions radially</p>	<p>Bianco Opaco 9010 Matte White 9010</p>	<p>Radial system</p>	<p>154027</p>
<p>CE </p>		<p>Peso netto: 1.05 Kg Net Weight:</p>	<p>Confezione Packaging</p>	<p>Peso Lordo: 1.41 Kg Gross Weight:</p>
		<p>n. Colli: 1 n. Pack:</p>	<p>Volume m³: 0.013 Volume m³:</p>	

Radial 28 Lights Round Radial Canopy | Rosone a Raggiera

	<p>Rosone circolare massimo 28 sospensioni a raggiera Ceiling bracket max 28 suspensions radially</p>	<p>Bianco Opaco 9010 Matte White 9010</p>	<p>Radial system</p>	<p>154028</p>
<p>CE </p>		<p>Peso netto: 3.35 Kg Net Weight:</p>	<p>Confezione Packaging</p>	<p>Peso Lordo: 4.19 Kg Gross Weight:</p>
		<p>n. Colli: 1 n. Pack:</p>	<p>Volume m³: 0.031 Volume m³:</p>	

ACCESSORY

MODELLO | MODEL INFO | INFO COLORE | COLOR SISTEMA | SYSTEM CODICE | CODE

Decentralization Cylinder | Cilindro

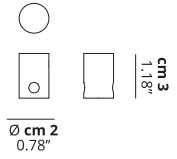
	<p>Cilindro di decentramento per RADIAL system Cavo elettrico max Ø 7 mm</p> <p>Wall & Ceiling anchor for RADIAL system Power cable max Ø 7 mm</p>	<p>Trasparente Clear</p> <p>Polycarbonato Polycarbonate</p>	<p>Radial system</p>	<p>130009</p>
<p>CE</p>		<p>Peso netto: 0.02 Kg Net Weight:</p>	<p>Confezione Packaging</p>	<p>Peso Lordo: 0.08 Kg Gross Weight: n. Colli: 1 n. Pack: Volume m³: 0.002</p>

Back Plate Puzzle Accessory | Accessorio

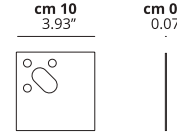
	<p>Piastra a muro opzionale per Puzzle e Puzzle Twist parete e plafoniera</p> <p>Optional backplate for Puzzle and Puzzle Twist Wall and Ceiling</p>	<p>Bianco Opaco 9016 Matte White 9016</p>	<p>Puzzle series Puzzle Twist series</p>	<p>146013</p>
<p>CE</p>		<p>Peso netto: 0.07 Kg Net Weight:</p>	<p>Confezione Packaging</p>	<p>Peso Lordo: 0.13 Kg Gross Weight: n. Colli: 1 n. Pack: Volume m³: 0.002</p>

Kit Cable

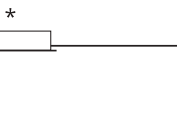
	<p>Kit extra per decentrare sospensioni con <u>cavo elettrico portante</u></p> <p>Extra kit for decentralizing suspension with <u>single power cable</u></p>	<p>* Bianco Opaco 9010 Matte White 9010</p> <p>AND</p> <p>** Trasparente Clear</p>	<p>A-Tube series Sugegasa series</p>	<p>130010</p>
<p>CE</p>		<p>Peso netto: 0.37 Kg Net Weight:</p>	<p>Confezione Packaging</p>	<p>Peso Lordo: 0.43 Kg Gross Weight: n. Colli: 1 n. Pack: Volume m³: 0.002</p>

Kit Steel

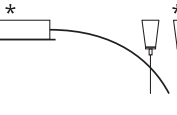
	<p>Kit extra per decentrare sospensioni con <u>funi d'acciaio</u></p> <p>Extra kit for decentralizing suspension with <u>steel cable</u></p>	<p>* Bianco Opaco 9010 Matte White 9010</p> <p>AND</p> <p>** Cromo Chrome</p>	<p>Kelly series Maggio series</p>	<p>130011</p>
<p>CE</p>		<p>Peso netto: 0.5 Kg Net Weight:</p>	<p>Confezione Packaging</p>	<p>Peso Lordo: 0.56 Kg Gross Weight: n. Colli: 1 n. Pack: Volume m³: 0.002</p>

Note | Notes:

THE
LIGHTING
MAKERS
2018

CONDIZIONI GENERALI DI VENDITA



Art. 1 - Premessa - Salvo deroga risultante da apposito accordo scritto tra le parti, ogni compravendita di prodotti di Studio Italia Design S.r.l., PIVA 02992370276 (di seguito: "SID") è regolata dalle seguenti Condizioni Generali di Vendita che costituiscono parte essenziale del contratto e che si intendono pertanto accettate dal Compratore ancorché dallo stesso non sottoscritte. Qualsiasi clausola unilateralmente apposta dal Compratore nei documenti da lui sottoscritti e/o nella sua corrispondenza, che sia contraria o comunque in aggiunta alle seguenti condizioni generali od a quelle speciali espressamente approvate per iscritto dal Venditore, si intende come non scritta ed è priva di ogni effetto.

Art. 2 - Perfezionamento della compravendita, quantitativi e prezzi - La compravendita si intende perfezionata con la conferma d'ordine scritta del Venditore anche a mezzo fax e/o posta elettronica o con l'inizio delle consegne per i casi in cui è stata richiesta l'immediata consegna della fornitura anche in presenza di modifiche intervenute e quindi accettate dal cliente. I prezzi concordati si intendono per prodotti consegnati franco stabilimento del Venditore e non comprendono prestazioni ed oneri accessori (quali IVA, imballo speciale, spese di trasporto, di installazione e/o montaggi e così via).

Art. 3 - Consegna, trasferimento del rischio e trasporto - La merce viene consegnata al Compratore presso lo stabilimento del Venditore o in altro sito dallo stesso indicato per iscritto, ed il trasferimento del rischio avviene con la consegna della stessa al primo vettore o al Compratore nelle ipotesi di ritiro della merce da quest'ultimo direttamente eseguita. La merce viaggia sempre a rischio esclusivo del Compratore anche quando il vettore dovesse essere scelto ed incaricato dal Venditore, essendo quest'ultimo liberato da ogni responsabilità con la consegna dei prodotti al vettore, che ad ogni effetto si intende eseguita a mani dallo stesso Compratore. I termini di consegna pattuiti si intendono indicativi. In caso di ritardo nella consegna imputabile al Venditore per un periodo fino a 60 gg il Compratore non ha il diritto di rifiutare la fornitura, né di richiedere la risoluzione del contratto e/o il risarcimento di alcun danno. Se il ritardo nella consegna supera il termine di 60 gg il Compratore ha la facoltà di richiedere - con lettera raccomandata - l'annullamento dell'ordine e la restituzione degli anticipi eventualmente versati. Resta in ogni caso escluso qualsivoglia obbligo del Venditore di risarcimento danni diretti e/o indiretti di qualsiasi natura e per qualsiasi ragione, in dipendenza del ritardo ovvero della mancata esecuzione della fornitura.

Art. 4 - Riserva di proprietà - Il Compratore acquista la proprietà della merce solo con il pagamento integrale del prezzo fatturato delle forniture ma ne assume i rischi dal momento della consegna.

Art. 5 - Caratteristiche dei prodotti e condizioni di utilizzo - Salvo diverso ed espresso accordo scritto tra le parti, i parametri funzionali dei prodotti sono quelli espressi comunicati o comunque risultanti nei disegni e specifiche tecniche del Venditore se esistenti o su quanto indicato sul sito web www.studioitaliadesign.com relativamente ai prodotti. I livelli di qualità dei prodotti forniti sono quelli standard del Venditore, evidenziati nelle relative specifiche o su quanto indicato e desumibile sul sito web del Venditore. E' onere del Compratore individuare e comunicare al Venditore le condizioni di utilizzo dei prodotti prima della relativa definizione tecnica. In mancanza di indicazioni da parte del Compratore il Venditore considera condizioni di utilizzo quelle di prassi dallo stesso considerate o esplicitate nei propri disegni e documentazione tecnica.

Art. 6 - Garanzie - I prodotti forniti sono coperti da garanzia per difetti di materiale e/o fabbricazione per un periodo di 24 mesi dalla consegna se il Compratore risulta essere una persona fisica, diversamente il periodo di garanzia sarà di 12 mesi dalla consegna. Il Venditore sostituisce i prodotti resi in detto periodo di garanzia e riconosciuti difettosi per vizi d'origine ovvero in alternativa ed a sua scelta accredita al Compratore una somma pari al prezzo già fatturato dei prodotti stessi, restando espressamente escluso e rinunciato qualsiasi diverso diritto o pretesa del Compratore anche a titolo di risarcimento danni diretti e/o indiretti o di rimborso di costi dallo stesso sostenuti (quali costo di riprese, di assistenza tecnica, di richiamo, ecc.). Eventuali difettosità o non conformità dei prodotti devono essere segnalate dal Compratore per iscritto al Venditore - a pena di decadenza - entro e non oltre 8 gg dalla data di ricevimento della merce; eventuali difetti occulti devono essere segnalati dal Compratore per iscritto al Venditore - sempre a pena di decadenza- entro 8 gg dalla relativa scoperta. Resta inteso che SID non sarà responsabile per alcun vizio ancorché occulto, comunicato per iscritto, oltre 24 mesi dalla consegna della merce. La garanzia non opera ove i difetti rilevati siano imputabili a negligenza del Compratore e/o ad impiego dei prodotti non conforme con le informazioni e le spiegazioni in ogni caso fornite dal Venditore, alle prescrizioni tecniche, ad errata progettazione, applicazione, montaggio o fabbricazione delle strutture ove sono installati, ad errata manutenzione operata da personale non autorizzato, a pulizia impropria in quanto effettuata con modalità o materiali non idonei, ad errato magazzinaggio, movimentazione e trasporto, ad uso improprio od incauto, anche in caso di impianto elettrico e portata dello stesso non idonea, ovvero a circostanze che comunque non possono ricollegarsi a difettosità di produzione da parte del Venditore. Ogni singolo prodotto SID è conforme alla marcatura richiesta dalla Comunità Europea con la direttiva 93/68 (ampliamento della direttiva 73/23) per confermare con una marcatura riconosciuta in tutta Europa, che le lampade sono state sottoposte alle prove di sicurezza elettrica richieste dalle norme Europee EN-60598-1-2 II ed. + CEI EN 60598-1 IV ed. corrispondenti norme italiane CEI 34-21 + CEI 34-23, norme per la sicurezza elettrica a cui fanno riferimento tutti gli istituti, compreso l'IMQ. I prodotti indicati con il marchio UL e/o ETL sono conformi alla normativa UL 1598/CAN/USA C22.2 No.250.0 o UL 153.

Art. 7 - Obblighi del Compratore - Il Compratore è tenuto a prendere immediatamente in consegna i prodotti affidati dal Venditore al vettore, ovvero - se diversamente concordato - a puntualmente ritirarli presso lo stabilimento del Venditore alla data di comunicazione di merce pronta che potrà avvenire con ogni mezzo da parte del Venditore. Ove il Compratore ritardi il ritiro dei prodotti per un periodo superiore a 10 gg, oltre al pagamento del prezzo deve corrispondere al Venditore un adeguato compenso pari al 2% al giorno dell'importo fatturato per il magazzinaggio degli stessi. Il Compratore deve effettuare i pagamenti normalmente, con le modalità e nei termini precisati in fattura. Sui ritardati pagamenti decorreranno, di pieno diritto e senza necessità di costituzione in mora, gli interessi di cui al D.lgs. n. 231/2002. In caso di ritardo dei pagamenti il Venditore ha diritto a sospendere immediatamente ogni fornitura, anche se dipendente da altri contratti con lo stesso Compratore. Il mancato pagamento nei termini pattuiti comporta in ogni caso la decadenza del Compratore dal beneficio del termine.

Art. 8 - Forza maggiore - Qualora il Venditore sia impossibilitato a rispettare il contratto per cause di forza maggiore o comunque indipendenti dalla sua volontà, i termini previsti per l'esecuzione della fornitura sono automaticamente prorogati per un periodo equivalente al perdurare degli effetti di tali cause. Qualora la causa impeditiva continui per più di 6 mesi entrambe le parti possono chiedere la risoluzione del contratto ed in tal caso il Venditore restituisce al Compratore gli anticipi eventualmente ricevuti, con esclusione di ogni e qualsiasi onere ulteriore a suo carico.

Art. 9 - Contratto - In caso di sottoscrizione di apposito contratto lo stesso con i suoi allegati contiene e riassume le obbligazioni validamente assunte dalle parti e per esse vincolanti. L'adempimento delle parti sarà oggetto di valutazione dell'effettiva esecuzione dei compiti e doveri contrattuali, da effettuarsi in buona fede, onestà e con equità. Le presenti Condizioni Generali di Vendita si applicheranno al contratto salvo deroga risultante da atto scritto o in esso contratto esplicitamente prevista.

Art. 10 - Controversie - Qualora dovesse verificarsi una qualsivoglia controversia avente ad oggetto la formazione, validità, interpretazione, esecuzione, modifica e risoluzione del contratto o delle presenti Condizioni Generali di Vendita, questa sarà risolta secondo i principi e le regole indicate nell'articolo 11 che segue.

Art. 11 - Foro competente e legge applicabile - Foro esclusivamente competente sarà quello di Venezia con esplicita esclusione di ogni altro foro alternativamente competente, e la legge applicabile quella italiana.

Art. 12 - Sito Web - Le presenti Condizioni Generali di Vendita, sono quelle risultanti sul sito web www.studioitaliadesign.com e sono stampabili e riproducibili su supporto cartaceo. SID si impegna ad aggiornare il sito web www.studioitaliadesign.com mediante la pubblicazione sullo stesso della versione di Condizioni Generali di Vendita di volta in volta modificata.

GENERAL CONDITIONS OF SALE



Art. 1 - Recital - Unless otherwise provided for in a separate written agreement between the parties, every sale of products of Studio Italia Design S.r.l., VAT 02992370276 (hereinafter, "SID") is governed by the following General Conditions of Sale that must be considered as an essential part of this agreement and shall be deemed to have been accepted by the Buyer even though the latter has not signed them. Any clause unilaterally added by the Buyer in the documentation signed by it and/or in its correspondence, being against or in any case in addition to the general conditions or to those specific expressly approved in writing by the Seller, shall be deemed as not written and shall be of no effect.

Art. 2 - Completion of the sale, quantities and prices - The sale is deemed to be completed once the Seller gives the written order confirmation also by fax and/or email or when deliveries are commenced in cases where the immediate delivery of the supply is requested, also in consideration of changes occurred and then accepted by the customer. The prices agreed are understood for products delivered ex works of the Seller and do not include services and accessory charges (such as VAT, special packaging, transport and installation costs, and/or assemblages and so on).

Art. 3 - Delivery, risk transfer and transport - Products are delivered to the Buyer at the Seller's plant or at another place indicated in writing by the Seller, and the risk transfer takes place with the delivery of the goods to the first carrier or Buyer in the events of collection of goods directly carried out by the latter. The products always travel at the Buyer's sole risk also when the carrier is selected and appointed by the Seller, being the latter freed from all responsibilities after having delivered the products to the carrier, this delivery is deemed to all effects being carried out directly by the said Buyer. The delivery terms agreed are to be understood as indicative. If the Seller is responsible for delay of delivery for a period of up to 60 days, the Buyer is not entitled either to refuse the supply or to request the termination of the agreement and/or the compensation for any damages. If the delay in delivery exceeds 60 days, the Buyer is entitled to request - by registered letter- the cancellation of the order and the reimbursement of the advances if paid. In any event, the Seller shall not be liable for and/or direct and indirect damages of any nature and for any reason due to the delay or the failure to carry out the supply.

Art. 4 - Reservation of title - The Buyer acquires property rights over the goods with the full payment of the price invoiced of the supplies but it takes the risks thereof as of the delivery.

Art. 5 - Products features and conditions of use - Unless otherwise expressly agreed in writing by the parties, the conditions for using of the products are those communicated or in any case resulting from the drawings and technical specifications of the Seller, if any, or as described in the website www.studioitaliadesign.com in relation to products. The quality levels of products are the standard quality levels of the Sellers, indicated in the relevant specifications as described on the Seller's website. It is always the Buyer's responsibility to identify and notify the Seller of the conditions of use of products before technically defining them. Failing any particular instructions from the Buyer, the Seller considers as usual conditions of use those it considered or described in its designs and technical documentation.

Art. 6 - Warranties - The products delivered are covered by a warranty for defects in material and manufacture for a period of 24 months as of the delivery if the Buyer is a natural person, otherwise the warranty period will be of 12 months as of the delivery. The Seller shall replace the products delivered in this warranty period being faulty due to factory defects or in alternative, at its discretion, pay the Buyer an amount equal to the price already invoiced of the said products, being expressly excluded and waived any other right or claim by the Buyer also as compensation for direct and/or indirect damages or cost repayment borne by it (such as recovery, technical assistance, recalling costs, etc.). Any defectiveness or non-compliance of products shall be reported by the Buyer by writing to the Seller - in order to be valid - within 8 days from receipt of goods; any hidden defects shall be reported by the Buyer by writing to the Seller - always in order to be valid - within 8 days as of the relevant discovery. It being understood that SID will not be responsible for any defect even though hidden, being notified in writing, after 24 months of the delivery of goods. The warranty does not apply where the defects identified are due to the Buyer's negligence and/or to the use of products being not compliant with the information and explanations in any case gave by the Seller, technical provisions, to incorrect design, application, assembly or manufacture of the facilities in which they are installed, to incorrect maintenance carried out by unauthorized personnel, to improper cleaning since it is made with materials and manners being not suitable, to incorrect storage, handling and transport, to improper or imprudent use, also in the event of electrical system and its capacity being not suitable, or to circumstances that in any case cannot be related to the production defectiveness by the Seller. Every single product of SID corresponds to the mark laid down by the European Community with Directive 93/68 (extension of Directive 73/23) to confirm, with a mark recognized all over Europe, that the lights have undergone the electrical safety test required by European standards EN-60598-1-2 II ed. + CEI EN 60598-1 IV ed. corresponding to Italian standards CEI 34-21 + CEI 34-23, electrical safety standards referred to by all institutions, including the IMQ. The products indicated with the logo UL and/or ETL corresponds to the standards UL 1598/CAN/USA C22.2 No.250.0 o UL 153.

Art. 7 - Buyer's Obligations - The Buyer is required to immediately take delivery of the goods given by the Seller to the carrier, or - where otherwise agreed - to timely collect them at the Seller's plant on the date on which the Seller communicates, by any means, that the goods are ready. Where the Buyer delays the collection of the production for a period exceeding 10 days, in addition to the payment of price it shall pay the Seller a proper compensation equal to 2% per day of the price invoiced for storing such products. The Buyer shall carry out the payments normally, in accordance with the terms and conditions specified in the invoice. For late payments it will be accrued by default without need of further notification interest under Legislative Decree no. 231/2002. In the event of payment delays, the Seller is entitled to immediately suspend any supply, even though it has concluded other agreements with the same Buyer. The failure to pay within the terms agreed will cause in any event the loss of favourable terms for the Buyer.

Art. 8 - Force majeure - If the Seller is unable to comply with the agreement due to force majeure or beyond its control events, the deadlines set for the supply are automatically extended for a period in which these effects continue. Where the obstacle to comply with the agreement is longer than 6 months, both parties may request the termination of the agreement and, in such event, the Seller repay the Buyer the advances received, if any, releasing itself from any additional obligation on it.

Art. 9 - Agreement - In the event of execution of a specific agreement signed by the parties, the said agreement together with its Annexes provides for and summarizes the obligations validly undertaken by the parties and being binding for them. The fulfilment by the parties will be subject to effective evaluation of the actual performance of the contractual tasks and duties to be carried out in good faith, with honesty and fairness. These General Conditions of Sale shall apply to the agreement, unless otherwise provided in writing by the parties or expressly provided in the said agreement.

Art. 10 - Disputes - Any dispute which may arise concerning the signing, validity, interpretation, performance, amendment and termination of the agreement or of these General Conditions of Sale will be settled according to principles and rule set forth in Article 11 below.

Art. 11 - Jurisdiction and Applicable Law - The Court of Venice shall be held exclusively competent, being any other court of competent jurisdiction expressly excluded, and the Italian Law shall be applicable.

Art. 12 - Website - These General Conditions of Sale are those indicated on the website www.studioitaliadesign.com and may be printed and reproduced on paper. SID undertakes to update the website www.studioitaliadesign.com by publishing on it the version of the General Conditions of Sale as amended from time to time.

THE
LIGHTING
MAKERS
2018

STUDIO
ITALIA DESIGN
LIGHTING MAKERS

THE
LIGHTING
MAKERS
2018

STUDIO
ITALIA DESIGN
LIGHTING MAKERS

Art Direction and set design:
Raimondo Sandri

Photos:
Studio Pointer
Stefano Scatà
Andrea Pancino

Printer:
Grafiche Tintoretto

Special thanks to:
Renzo Tortato
Loris Casonato
Gatti VilleVenete Treviso
Enrico
Ometto Arredamenti
Solinfo
Glamora

DK Interiors
By Sandra Interior Design
Spectra Design
Interior Design Studio
Licht Impulse in Fuerth
Kastner Brillen Haus in Fuerth

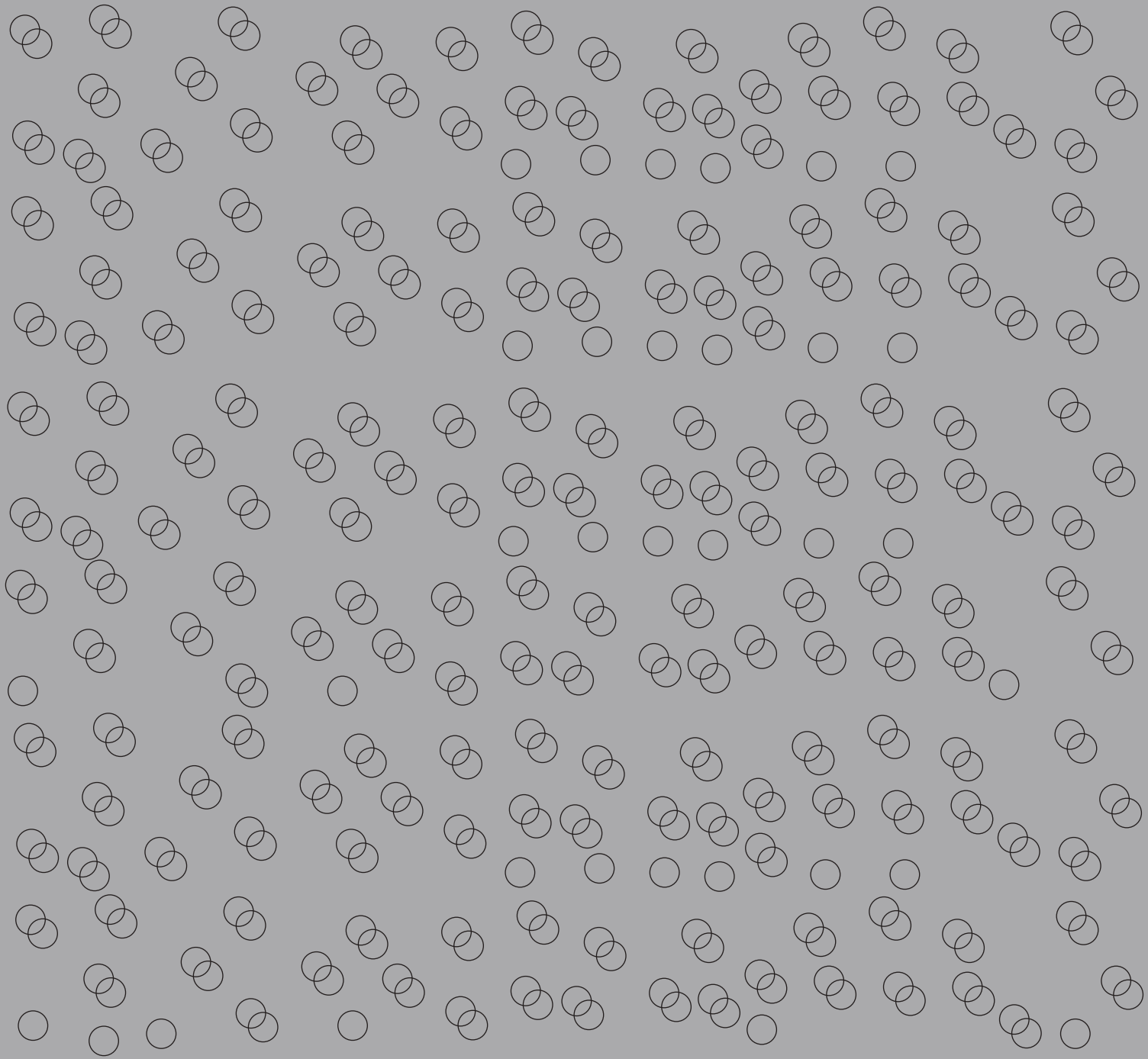

STUDIO ITALIA DESIGN
Via Pialoi, 32
30020 Marcon - Venezia - ITALY
tel +39 041 4569266
fax +39 041 4567337
info@studioitaliadesign.com
www.studioitaliadesign.com