

lifeAGLOW®

# HINKLEY

L I G H T I N G

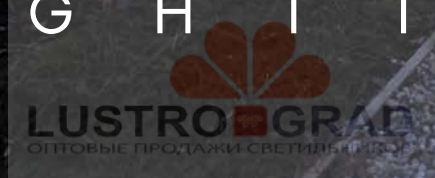



# HINKLEY

L I G H T I N G

CLASSIC, CHIC COLLECTIONS | [HINKLEYLIGHTING.COM](http://HINKLEYLIGHTING.COM)



## FREDRICK RAMOND

ESTABLISHED 1965

HINKLEY'S LUXURY LINE | [FREDRICKRAMOND.COM](http://FREDRICKRAMOND.COM)

THIS CATALOG INCLUDES THE FULL LINE OF HINKLEY LANDSCAPE LIGHTING.  
FOR HINKLEY INTERIOR, BATH, EXTERIOR AND FREDRICK RAMOND,  
PLEASE SEE THE HINKLEY LIGHTING 2015-2016 CATALOG.

HINKLEY LIGHTING, INC. | 2016

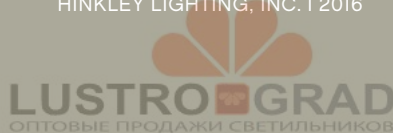

# LANDSCAPE CONTENTS

## expand **YOUR** **HORIZONS**

Hinkley Landscape Lighting allows you to creatively illuminate all types of exterior environments and increase enjoyment of your favorite natural spaces throughout the evening hours. Explore all we have to offer: from inspiration to installation, we've got you covered.

“Landscape lighting is essential to safety and appearance. Proper outdoor lighting can transform a space at night into a work of art.”

**CHRISTINA FLUEGGE**  
GREIGE DESIGN  
SAN JOSE, CA

COVER PHOTO:  
PETER FRANK EDWARDS / COASTAL LIVING

## WELCOME TO HINKLEY LANDSCAPE LIGHTING

Coordinating Lanterns	05
Hinkley Resources	02
Idea Center	03
Lighting Techniques	08
LED Details	14

### 12 VOLT LANDSCAPE LIGHTING

<b>ACCENT LIGHTING</b>	15
Spot + Flood Lights	16
Well Lights	22

<b>DECK, STEP AND PATIO LIGHTING</b>	49
Brick Lights	57
Deck Lights	52
Luna Step Light	51
Nuvi Hardscape	50

### NEXUS COLLECTION

<b>PATH + AREA LIGHTING</b>	25
Bollards	26
Path Lights	30

### 120 VOLT LANDSCAPE LIGHTING

Luna Step Light	64
Path Lights	61
Spot + Flood Lights	61
Step + Brick Lights	68
Well Lights	70

### CARSON OUTDOOR CHANDELIERS

58

### ACCESSORIES

12 Volt	73
120 Volt	71

### LIGHT BULBS

1536 Series Photometrics	78
Halogen	82
LED	80

### TRANSFORMERS

76

### DESIGN + INSTALLATION GUIDES

Incandescent	86
LED	84

Index	89
-------	----

## LANDSCAPE LIGHTING 101™



A COMPLETE GUIDE TO PLANNING AND PLACING LANDSCAPE LIGHTING FIXTURES TO ACCENT YOUR PROPERTY AND HIGHLIGHT YOUR HOME.

**SEE PAGE 10.**

# RESOURCES *for* STYLE

## designer DNA

AS A PART OF OUR 'LIFE AGLOW' CAMPAIGN, HINKLEY INTERVIEWED ACCLAIMED DESIGNERS, STYLISTS AND BLOGGERS TO BRING YOU INVALUABLE IDEAS ON SELECTING THE RIGHT LIGHTING. LOOK FOR THEIR INSIDE SECRETS THAT OFFER INFORMATIVE AND ENTERTAINING RECOMMENDATIONS THROUGHOUT THIS CATALOG AND IN OUR ONLINE IDEA CENTER.

*For full bios on each contributor, visit [hinkleylighting.com](http://hinkleylighting.com)*

DISCOVER **HINKLEYLIGHTING.COM**

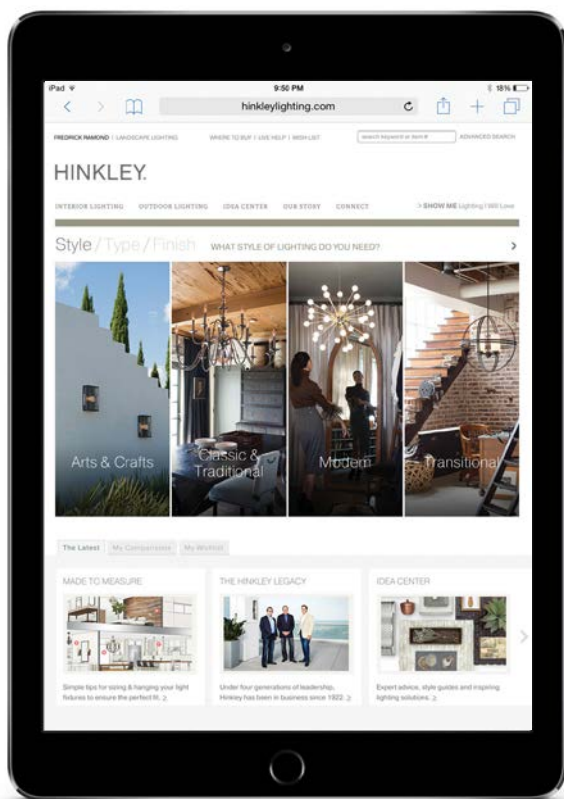

## FIND LIGHTING *love* YOU WILL

Explore the digital version of our catalogs and be inspired by the home décor tips, style guides and product videos in our online Idea Center. Enjoy shopping by style, application and finish to find lighting you will love.



DISCOVER THE BENEFITS OF HINKLEY LANDSCAPE LIGHTING ON OUR YOUTUBE CHANNEL

## TALK IS CHIC

JOIN OUR SOCIAL CIRCLE TO KEEP UP WITH HINKLEY HAPPENINGS

*#hinkleylighting #lifeaglow*

**f FACEBOOK**  
FACEBOOK.COM/HINKLEYLIGHTING  
Keep up with current Hinkley activity.

**t TWITTER**  
TWITTER.COM/HINKLEYLIGHTING  
Join the conversation and hear what Hinkley has to say.

**YouTube**  
YOUTUBE.COM/HINKLEYLIGHTINGINC  
Watch our informative product and engaging brand videos.

**houzz**  
HOZZ.COM/HINKLEYLIGHTING  
Discover our products in all types of places and spaces.

**Instagram**  
INSTAGRAM.COM/HINKLEYLIGHTING  
See what's happening around Hinkley.

**PINTEREST**  
PINTEREST.COM/HINKLEYLIGHTING  
Find out what inspires us.



# IDEACENTER

## LANDSCAPE



SATURN 1579SS, PAGE 34

### EXPAND YOUR ENVIRONMENT

Balance creature comforts with the call of the wild! Enjoy your property in its entirety by unifying the relationship between your home and your natural surroundings. Integrating decorative fixtures with the essential landscape lighting techniques on pages 8-9 will tastefully illuminate everything from lush walkways to chic chaises and cozy eating alcoves.

Let the outdoors in by creating layered exterior living spaces that blend the best of both worlds. By adding elements of outdoor and landscape lighting, you can craft defined areas to lounge and linger, day or night.

“Being able to see outside at night is a wonderful way to enlarge the feeling of the size of the property. The exterior becomes an extension of the interior and helps create the multi-dimensional home.”

**KATIE LYDON** | KATIE LYDON INTERIORS  
NEW YORK, NY

THE BEST OUTDOOR LIGHTING PLANS EXPAND YOUR LIVING ENVIRONMENT, HEIGHTEN CURB APPEAL AND ADD SAFETY TO YOUR OUTDOOR SPACE. HINKLEY RECOMMENDS TAKING A SMART AND MEASURED APPROACH TO ENSURE YOUR LIGHTING DESIGN IS PURE PERFECTION:

## HINKLEY LANDSCAPE LIGHTING PLAN-O-GRAM

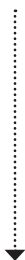

1

ASSESS YOUR EXTERIOR AND SELECT THE AREAS YOU WANT TO ILLUMINATE

2

CHOOSE DECORATIVE FIXTURES THAT COMPLEMENT ARCHITECTURE AND ELEMENTS OF LANDSCAPING

3

CHOOSE FROM A VARIETY OF DISTINCTIVE LIGHTING TECHNIQUES SHOWN ON PAGES 8-9

4

RESEARCH ENERGY-EFFICIENT LED FIXTURE OPTIONS FOR LONG-TERM SAVINGS

5

BASED ON INSTALLATION REQUIREMENTS AND YOUR LANDSCAPING NEEDS, SELECT YOUR FIXTURES AND ACCESSORIES

6

TAKE INTO ACCOUNT THE APPROPRIATE LAMPING BASED ON LIGHT INTENSITY AND BEAM SPREAD

7

SELECT THE PROPER TRANSFORMER TO PROVIDE THE CORRECT POWER SUPPLY

8

CHOOSE CONTROLS TO TURN THE LIGHTS ON AND OFF, ADDING AN ADDITIONAL MAINTENANCE-FREE AMENITY

## TAKE CONTROL

INSTALLING A DIMMER FOR LANDSCAPE LIGHTING gives you the flexibility to control the ambiance of your outdoor areas and adjust your exterior lighting based on its use—from a brighter light surrounding a lively social gathering on the deck or a softer glow for intimate evening dinners al fresco. Utilizing a dimmer for the exterior lighting of your home is simple: just ensure the outlet that the transformer plugs into is dedicated and offers that functionality, and it automatically increases the luxury quotient of your property. Installation by a professional will ensure the dimmer system functions properly and that local code requirements are followed. Rapid advances in technology also allow certain home lighting control systems to work from your smart phone, so you can reduce power usage when not in use or adjust the lighting to create different moods... all at the touch of a finger. Visit Hinkley Landscape Lighting online and use our showroom locator to find a knowledgeable distributor in your area that can answer questions about lighting control systems.



# COORDINATE & Complement

To help you complete your lighting vision in style, Hinkley offers a wide variety of **OUTDOOR LANTERN FAMILIES** that coordinate with our landscape lighting designs. See Hinkley's full line catalog or visit us online at **HINKLEYLIGHTING.COM**

## ATLANTIS

ATLANTIS BOLLARDS, PAGE 28  
ATLANTIS PATH LIGHTS, PAGES 32-33  
COORDINATING LANTERNS, PAGES 582-585  
IN HINKLEY'S FULL-LINE CATALOG

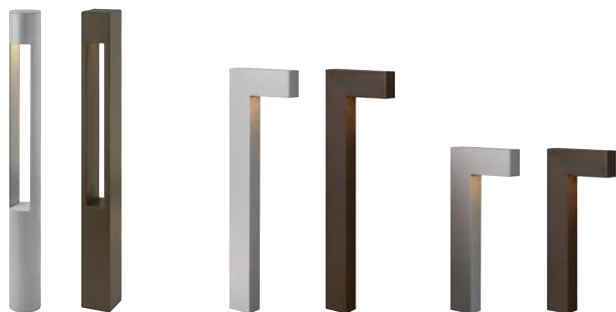



## HIGH PERFORMANCE BOLLARDS

BEGINNING ON PAGE 26

PERFECT FOR PUBLIC AND COMMERCIAL APPLICATIONS

- + STREAMLINED DESIGN
- + DURABILITY
- + MAXIMUM LIGHT OUTPUT

## SHELTER

SHELTER BOLLARDS, PAGE 27 | SHELTER PATH LIGHTS, PAGE 34

COORDINATING LANTERNS, PAGES 604-609 IN HINKLEY'S FULL LINE CATALOG



## LUNA

LUNA BOLLARDS, PAGE 27

COORDINATING LANTERNS, PAGES 578-581 IN HINKLEY'S FULL LINE CATALOG



## DORIAN

DORIAN BOLLARDS, PAGE 29

COORDINATING LANTERNS, PAGES 614-615 IN HINKLEY'S FULL LINE CATALOG



## SOLARA

SOLARA BOLLARDS, PAGE 29

COORDINATING LANTERNS, PAGES 612-613 IN HINKLEY'S FULL LINE CATALOG



**MAKE A COHESIVE STYLE STATEMENT!**

SEE HINKLEY'S FULL LINE CATALOG FOR COORDINATING OUTDOOR LANTERNS



## SATURN

SATURN PATH LIGHTS, PAGE 34  
COORDINATING LANTERNS, PAGES 574-577  
IN HINKLEY'S FULL LINE CATALOG



## TRELLIS

TRELLIS PATH LIGHT, PAGE 43  
COORDINATING LANTERNS, PAGES 684-686  
IN HINKLEY'S FULL LINE CATALOG



## LEDGEWOOD

LEDGEWOOD PATH LIGHT, PAGE 44  
COORDINATING LANTERNS, PG 624-625  
IN HINKLEY'S FULL LINE CATALOG



## RALEY

RALEY PATH LIGHT, PAGE 43  
COORDINATING LANTERNS, PAGES 700-701  
IN HINKLEY'S FULL LINE CATALOG



## HARBOR

HARBOR PATH LIGHTS, PAGE 35  
COORDINATING LANTERNS, PAGES 560-565  
IN HINKLEY'S FULL LINE CATALOG



## PLANTATION

PLANTATION PATH LIGHT, PAGE 43  
COORDINATING LANTERNS, PAGES 696-697  
IN HINKLEY'S FULL LINE CATALOG



## BOLLA

BOLLA PATH LIGHT, PAGE 41  
COORDINATING LANTERNS, PAGES 650-653  
IN HINKLEY'S FULL LINE CATALOG



## MONTICELLO

MONTICELLO PATH LIGHT, PAGE 40  
COORDINATING LANTERNS, PAGES 736-737  
IN HINKLEY'S FULL LINE CATALOG



# LANDSCAPE LIGHTING TECHNIQUES

EVERY NEED-TO-KNOW METHOD FOR LIGHTING UP THE NIGHT



1536MZ-3WLEDFL

## UPLIGHTING ^

Uplighting is illuminating an area, surface or object from below to create a focal point in the landscape.

**CREATING THIS EFFECT :** A spot light is aimed at the tree in the foreground while the front of the home remains relatively dark.

## < WALL WASHING

Wall washing is a technique that refers to the general illumination of a wall or surface.

**CREATING THIS EFFECT :** Spot lights are placed along the front of the home to create a soft wash of light.



16571MZ-LED

## SILHOUETTING v

Also called backlighting, silhouetting is used to dramatize an interesting shaped object.

**CREATING THIS EFFECT :** A spot light is placed between the tree and the front of the home. The spot light is aimed at the front of the home creating a dramatic silhouette of the tree.



16571MZ-LED



1536MZ-3WLEDFL

## SHADOWING ^

Shadowing is an effect created by placing a light source in front of an object and projecting a shadow onto a surface behind the object.

**CREATING THIS EFFECT :** Spot lights are placed directly in front of the tall bushes, producing shadows which are projected on the home's face, creating an interesting and inviting façade.





### GRAZING ^

Grazing emphasizes a textured surface (such as a tree trunk, a stone wall, climbing ivy, etc.) by placing a light source within one foot of that surface and aiming the light beam parallel to that surface.

**CREATING THIS EFFECT :** Spot lights are placed beneath each stone pillar to create dimension, complementing the home's entryway.

### STEP LIGHTING v

Step and brick lights can be used in masonry and wood constructions. These fixtures are designed to safely illuminate stairways and walkways.

**CREATING THIS EFFECT :** The steps are gently illuminated leading up to the doorway to ensure safety.



### < PATH LIGHTING

Path and area lighting is used to enhance dynamic landscaping elements such as flower beds, shrubbery and borders while safely illuminating pathways.

**CREATING THIS EFFECT :** Path lights are staggered around the walkway to create pools of light that illuminate a safe passage to the home's entrance.

### DECK LIGHTING >

Step, brick and hardscape lighting can be used in masonry and wood constructions. These fixtures are specifically designed to provide safety and accent lighting while creating a warm atmosphere.

**CREATING THIS EFFECT :** A surface mounted deck sconce is placed on the wall above each step to illuminate a safe entryway to the deck. A hardscape fixture under the bench, coupled with deck sconces mounted to the corner posts create a soft glow.



# LANDSCAPE LIGHTING 101™

A COMPLETE GUIDE TO PLANNING AND PLACING LANDSCAPE LIGHTING FIXTURES TO ACCENT YOUR PROPERTY AND HIGHLIGHT YOUR HOME.

[FOLD OUT FOR A FULL VIEW >](#)

## 1 SPOT LIGHTS

Spot lights are the go-to fixture to highlight elements of your landscape that add the most visual appeal, such as foliage, trees and architectural elements. Hinkley offers a wide range of spot lights to fit any need.

## 2 LUNA STEP LIGHT

Available in 12V and 120V and a variety of colors (both double and single gang), the Luna Step Light is a versatile way to safely illuminate areas of foot traffic both indoors and out. Also fully dimmable, these fixtures allow customization of light output with only 4w of power consumption.

## 3 HARDSCAPE LIGHTING

Hardscape lighting is the perfect light source to use on retaining walls of all types, brick or stone columns and under all types of steps including wood, stone, brick and composite. It can also be used on the underside of a wide variety of outdoor surfaces including built in seating, pergolas, hand railing and fence rails. The Nexus collection of hardscape lighting is available in white and bronze to blend with all exterior styles.

## 4 GRAZING

Grazing is a technique used to emphasize a textured surface or architectural element (such as a tree trunk, a stone wall, climbing ivy, etc.) by placing a light source within one foot of the surface and aiming the light beam parallel to that surface. This technique can be accomplished with different types of Hinkley Landscape Lighting, like spot lights, well lights and Nexus fixtures.

## 5 STEP LIGHTING

Step lighting is a safety must for any outdoor zones with elevation elements, especially in areas without overhead illumination. Take the traffic pattern of your space into account to cover commonly used areas.

**STAIRWAY WIDTH** step lights should be installed on the horizontal center of each riser, taking the fixture's louver angle into account for light reach.

**WIDE AREA WIDTH** step lights are generally installed 4'-6' apart, depending on fixture width.

## 6 DECK LIGHTING

Installing deck lights adds safety and illumination to your favorite outdoor entertaining space. Fixtures are most often installed into the posts of a deck to provide proper light output around the perimeter of the space.

## 7 OUTDOOR PENDANTS

Exterior pendants and hanging lanterns can be used as a lighting source to illuminate and accent an outdoor dining space. A general guideline to follow is the same as interior pendants, which is for the bottom of the fixture to sit 28"-34" above the table.

## 8 OUTDOOR FLUSH MOUNTS

Flush mounts are the perfect lighting selection for second story balconies or overhangs to provide a nighttime glow for outdoor seating and activity.

## 9 OUTDOOR LANTERNS

Lanterns mounted at a point of entry to the home provide safety, security, and a welcoming decorative element.

**ONE LANTERN** should measure about 1/3 the height of your door.

**TWO LANTERNS** should measure about 1/4 the height of the door. In all cases, the center of the light source should rest about 66" above the threshold.

## 10 PATH LIGHTING

Path lighting is the perfect way to add style and safety to a walkway. Lights should be placed about 6' apart from one another, and staggered on either side of the path. Consider the light output of your fixtures to determine spacing that keeps the light from overlapping.

## 11 SHADOWING

Shadowing is an effect created by placing a light source, often a spot light, in front of an object and projecting a shadow onto a surface behind the object, such as the shadow of a tree onto a home's façade.

## 12 UPLIGHTING

Uplighting is illuminating an area, surface or object from below to create a focal point in the landscape. Spot lights and well lights are the most common fixtures to use in this application. Consider the width of the area you will be illuminating when choosing the beam spread of the fixture or bulb.

## 13 TRANSFORMER

Transformers convert your 120-volt household current to 12-volt. Calculate the total lamp wattage, or VA for LED, that your system requires and choose a transformer powerful enough to handle the total wattage/VA with extra capacity.

**EXTERIOR INSTALLATION** on the side or back of the home must be mounted 12" from the ground next to an outlet.

**INTERIOR INSTALLATION** such as in a basement, garage or shed must be listed for that application. UL code also requires an additional plate to guard against fire and conduit must be used when running wiring through an interior wall.

*illuminating interiors*

VISIT [HINKLEYLIGHTING.COM](http://HINKLEYLIGHTING.COM) TO VIEW THE ORIGINAL LIGHTING 101, YOUR GUIDE TO SELECTING AND SIZING A HOME FULL OF FIXTURES.





# THE MAKINGS OF A *fabulous* FAÇADE

EMBARK ON YOUR STYLE SEARCH

Entryway lighting is the optimal accessory to the front of your home, serving as a welcoming feature for your family and guests. Keep in mind that when selecting decorative outdoor lighting, it is best to stay true to the period and architectural style of your home's exterior. Choose path lights and outdoor lanterns that are complementary to one another and the style of your home, as well as the natural environment that surrounds it.

## *If your home is* **TRADITIONAL** >

Look for elegant lighting with design details such as beveled glass, stately scrollwork and rich, dark finishes in shades of bronze.



HARDY ISLAND 16007MZ-LED, PAGE 38  
TRELIS 1435RB, HINKLEY FULL LINE CATALOG



ATLANTIS 1518HE-LED, PAGE 32  
ATLANTIS 1641TT-LED,  
HINKLEY FULL LINE CATALOG

## *If your home is* **TRANSITIONAL**

Take architectural details into account. Does your home radiate a refined rustic vibe? Weathered finishes could be your go-to. If your property has coastal character, nautical-inspired cast brass fixtures are a must for design and durability.

## < *If your home is* **MODERN**

Your space will shine with chic, minimalist styles that showcase clean, contemporary lines. Try a titanium or hematite finish to complement cooler-toned stonework or concrete. To enhance your modern decor, consider path lights and lanterns with seeded glass, which will produce a subtle yet stylish pattern of light.

**NO MATTER THE LOOK OF YOUR PROPERTY,  
ENERGY-EFFICIENCY IS ALWAYS ON TREND.**

Hinkley offers the widest range of decorative LED designs in the industry to illuminate your home's exterior, ranging from traditional to modern and every style in between.





**1**  
**SPOT LIGHTS**  
Accent Lighting  
Page 15

**2**  
**LUNA  
STEP LIGHT**  
12V, Page 51  
120V, Page 64

**3**  
**HARDSCAPE  
LIGHTING**  
Nexus Hardscape  
Page 48

**4**  
**GRAZING**  
Landscape  
Lighting  
Techniques  
Pages 8-9

**5**  
**STEP LIGHTING**  
Deck, Step and  
Patio Lighting  
Page 49

**6**  
**DECK LIGHTING**  
Deck, Step and  
Patio Lighting  
Page 49

**7**  
**OUTDOOR  
PENDANTS**  
Full Line Catalog  
[hinkleylighting.com](http://hinkleylighting.com)





8

**OUTDOOR  
FLUSH MOUNTS**

Full Line Catalog  
[hinkleylighting.com](http://hinkleylighting.com)

9

**LANTERNS**

Full Line Catalog  
[hinkleylighting.com](http://hinkleylighting.com)

10

**PATH  
LIGHTING**

Page 25

11

**SHADOWING**

Landscape  
Lighting  
Techniques  
Pages 8-9

12

**UPLIGHTING**

Landscape  
Lighting  
Techniques  
Pages 8-9

13

**TRANSFORMERS**

Pages 76-77

# ReTHINK LED

What's the big deal about the alternatives to traditional lighting? There are many reasons to be excited about new illumination methods like solid state lighting. The most popular form, LED, benefits both the user and our planet, and who doesn't like win/win scenarios? Let's take a look at a few of its advantages:

## LONG LIFE

A long service life is one of the most thrilling aspects of LED lighting. It can have an operational life of up to 100,000 hours! That's equal to about 20 years of traditional use. And since they don't automatically "burn out," LEDs will simply become less bright near the end of their life span.

## ENERGY EFFICIENT

Energy efficiency is top of mind when thinking about lighting consumption. LEDs offer stellar efficacy, or lumens of light output per watt of electrical input. Since it also decreases the amount of needed maintenance, these benefits can apply to both residential or urban applications.

## ECO-FRIENDLY

Completely free of toxic materials, LEDs are ecologically friendly and 100% recyclable. With a longer life span and less replacement needed, this will also save on overall materials and that is always good news for our planet!

## DURABILITY

Built to withstand extreme weather conditions and temperature variations, don't let the compact size of an LED fool you. They are optimal for outdoor lighting systems and don't have the more fragile filament or arc tube, which can break.

## REDUCED UV EMISSIONS

LEDs produce extremely minimal infrared light and UV emissions during the light transmission. This means few limitations while considering the illumination of heat-sensitive objects or materials, allowing extreme flexibility in design applications.

## LOW VOLTAGE POWER SUPPLY

Since this is sufficient for LED, landscape lighting is a breeze and allows this amazing technology to enhance and benefit your outdoor lighting plans.

## LIGHT DISPERSION

LED is designed to focus its light and brighten up immediately while being directed to a specific location without the need for an external reflector, making this little guy a bundle of efficiency.

## HINKLEY INTEGRATED LED

See page 14 for the technical specifications associated with Hinkley's integrated technology. Visit [hinkleylighting.com](http://hinkleylighting.com) to view the patents held by Hinkley products.



NEXUS 15471BZ AND 15472BZ, PAGE 46



## BRAVING *the* ELEMENTS

“The salt air in the low-country can be brutal, so it's crucial to consider lighting, furniture and fabrics that are going to withstand the different climates.”

GINGER BREWTON  
GINGER BREWTON INTERIORS  
CHARLESTON, SC



# HARDY ISLAND

HARDY ISLAND 1536MZ, PAGE 16, AND 16022MZ-LED, PAGE 39

Named for the ruggedly beautiful island off the coast of British Columbia that bears its name, Hardy Island is designed to defy the harshest environments in style. Hardy Island offers fully enclosed lamps, features a weathered brass finish that will mature naturally over time and is backed by a lifetime warranty.



**HARDY ISLAND** IS A HEAVY DUTY SOLID CAST BRASS COLLECTION, THE PERFECT COLLABORATION OF FORM AND FUNCTION.

 look for Hardy Island fixtures throughout the catalog

PATH

SPOT

DECK & STEP

ACCENT

# LED-ING *the way*

HINKLEY'S GUIDE TO  
OUR INDUSTRY LEADING,  
ENERGY-EFFICIENT  
LED LIGHT SOURCES

**INTELLIGENT LIGHTING** HINKLEY IS DEDICATED TO PROVIDING STATE-OF-THE-ART PRODUCTS BY UTILIZING THE LATEST TECHNOLOGY AND CUTTING EDGE COMPONENTS. BELOW ARE THE ENGINES AND SPECIFICATIONS FOR HINKLEY'S INTEGRATED LED.

## INTEGRATED LED

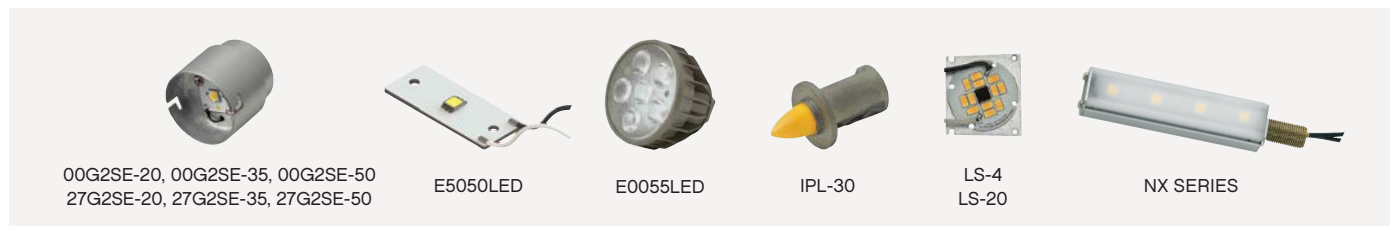

## LED ENGINES *Not Available to Purchase*

ITEM	DESCRIPTION	ENGINE LUMENS	COLOR TEMP.	CRI	WATTS CONSUMED	VA	INCANDESCENT EQUIVALENCY	LIFESPAN	DIMMABLE
00G2SE-20	Integrated MR Lamp Engine	See pages 78-79	80	3W	3.2VA	20W	60,000	-	
00G2SE-35	Integrated MR Lamp Engine	See pages 78-79	80	5W	5.3VA	35W	60,000	-	
00G2SE-50	Integrated MR Lamp Engine	See pages 78-79	80	7.5W	7.8VA	50W	60,000	-	
27G2SE-20	Integrated MR Lamp Engine	See pages 78-79	80	3W	3.2VA	20W	60,000	-	
27G2SE-35	Integrated MR Lamp Engine	See pages 78-79	80	5W	5.3VA	35W	60,000	-	
27G2SE-50	Integrated MR Lamp Engine	See pages 78-79	80	7.5W	7.8VA	50W	60,000	-	
E0055LED	Integrated R Lamp Engine	450	3000	80	7.0W	-	50W	35,000	-
E5050LED	Integrated Deck Light Engine	120	2700	80	1.5W	2.4VA	12W	40,000	MLV*
IPL-30	Integrated Path Light Engine	120	2700	80	2.3W	3.9VA	12W	60,000	MLV*
LS-4	Integrated Low Voltage Step Light Engine	200	2700	90	3.8W	6.5VA	20W	40,000	MLV*
LS-20	Integrated Line Voltage Step Light Engine	240	2700	90	4W	-	20W	40,000	ANY**
NX3	Integrated Linear Engine	250	2700	80	3.8W	5.7VA	25W	40,000	MLV*
NX4	Integrated Linear Engine	140	2700	80	1.9W	2.8VA	20W	40,000	MLV*
NX6	Integrated Linear Engine	250	2700	80	3.8W	5.7VA	25W	40,000	MLV*
NX12	Integrated Linear Engine	500	2700	80	7.3W	10.8VA	50W	40,000	MLV*

\*MLV: Magnetic Low Voltage control on primary (120VAC) side of transformer. \*\*ANY: Any phase cut incandescent dimmer control. Values are subject to change, so be sure to reference hinkleylighting.com for the most up-to-date energy-efficient specs.

VIEW PAGES 80-81 FOR LED BULBS AVAILABLE FOR PURCHASE

## ICON GUIDE

Throughout this catalog we have utilized a variety of important icons to assist with your lighting selections. This key describes each icon in detail for easy reference.



**INTEGRATED LED**  
Each energy-efficient fixture is equipped with a fully integrated LED panel and built-in driver.



**120 VOLT**  
Indicates a line voltage fixture that is able to accommodate lamps with a higher wattage and light output. Ideal for commercial and public spaces.



**HARDY ISLAND**  
Fixture is constructed from heavy duty solid cast brass and features a weathered brass finish. Designed for harsh environments. See page 13 for more information.



**COASTAL SERIES**  
Coastal Series fixtures are constructed from sturdy copper and brass. Designed for harsh environments.



# ACCENT LIGHTING



PHOTOGRAPHY BY PETER FRANK EDWARDS | COASTAL LIVING  
HARDY ISLAND 1536MZ-5W27FL, PAGE 16



# THE ONLY SPOT LIGHT YOU WILL EVER NEED

THE 1536 SERIES IS A CUTTING EDGE MODULAR LED LIGHT ENGINE SYSTEM DESIGNED TO MEET ANY SPOT LIGHT NEED.



FROM LEFT:  
**1536 MZ**  
HARDY ISLAND™ SPOT LIGHT  
2 1/2" DIA. SHROUD, 5 3/4" L, 3/4" H  
**1536 BZ**  
SPOT LIGHT  
2 1/2" DIA. SHROUD, 5 3/4" L, 3/4" H

**3 LENS OPTIONS** OFFER VERSATILITY IN BEAM SPREAD via an easy to remove and insert optic assembly

**LED ENGINES** AVAILABLE IN 3W, 5W AND 7.5W NOW IN BOTH 2700K AND 3000K



00G2FO-FLOOD  
FLOOD SPREAD LENS



00G2FO-MEDIUM  
MEDIUM SPREAD LENS



00G2FO-SPOT  
SPOT LENS



27G2SE-20, 27G2SE-35, 27G2SE-50  
CREE 2700K 3W, 5W, 7.5W LED  
00G2SE-20, 00G2SE-35, 00G2SE-50  
CREE 3000K 3W, 5W, 7.5W LED



Incorporates CREE LEDs with application performance tested by CREE.



**HARDY ISLAND**  **CAST BRASS SPOT LIGHTS**

 LED ITEM	DESCRIPTION	LED ENGINE (INCLUDED)	COLOR TEMP.	POWER SUPPLY REQUIREMENT	INCANDESCENT EQUIVALENCY	FINISH	CONSTRUCTION	GLASS LENS
<b>1536 MZ-3W27FL</b> <b>1536 MZ-3W27MD</b> <b>1536 MZ-3W27SP</b>	60° LED Flood Light 40° LED Medium Light 25° LED Spot Light	27G2SE-20	2700K	3w / 3.2VA	20w	Matte Bronze	Cast Brass	Clear*
<b>1536 MZ-5W27FL</b> <b>1536 MZ-5W27MD</b> <b>1536 MZ-5W27SP</b>	60° LED Flood Light 40° LED Medium Light 25° LED Spot Light	27G2SE-35	2700K	5w / 5.3VA	35w	Matte Bronze	Cast Brass	Clear*
<b>1536 MZ-8W27FL</b> <b>1536 MZ-8W27MD</b> <b>1536 MZ-8W27SP</b>	60° LED Flood Light 40° LED Medium Light 25° LED Spot Light	27G2SE-50	2700K	7.5w / 7.8VA	50w	Matte Bronze	Cast Brass	Clear*
<b>1536 MZ-3WLEDL</b> <b>1536 MZ-3WLEDMD</b> <b>1536 MZ-3WLEDSP</b>	60° LED Flood Light 40° LED Medium Light 25° LED Spot Light	00G2SE-20	3000K	3w / 3.2VA	20w	Matte Bronze	Cast Brass	Clear*
<b>1536 MZ-5WLEDL</b> <b>1536 MZ-5WLEDMD</b> <b>1536 MZ-5WLEDSP</b>	60° LED Flood Light 40° LED Medium Light 25° LED Spot Light	00G2SE-35	3000K	5w / 5.3VA	35w	Matte Bronze	Cast Brass	Clear*
<b>1536 MZ-8WLEDL</b> <b>1536 MZ-8WLEDMD</b> <b>1536 MZ-8WLEDSP</b>	60° LED Flood Light 40° LED Medium Light 25° LED Spot Light	00G2SE-50	3000K	7.5w / 7.8VA	50w	Matte Bronze	Cast Brass	Clear*

**CAST ALUMINUM SPOT LIGHTS**

 LED ITEM	DESCRIPTION	LED ENGINE (INCLUDED)	COLOR TEMP.	POWER SUPPLY REQUIREMENT	INCANDESCENT EQUIVALENCY	FINISH	CONSTRUCTION	GLASS LENS
<b>1536 BZ-3W27FL</b> <b>1536 BZ-3W27MD</b> <b>1536 BZ-3W27SP</b>	60° LED Flood Light 40° LED Medium Light 25° LED Spot Light	27G2SE-20	2700K	3w / 3.2VA	20w	Bronze	Cast Aluminum	Clear*
<b>1536 BZ-5W27FL</b> <b>1536 BZ-5W27MD</b> <b>1536 BZ-5W27SP</b>	60° LED Flood Light 40° LED Medium Light 25° LED Spot Light	27G2SE-35	2700K	5w / 5.3VA	35w	Bronze	Cast Aluminum	Clear*
<b>1536 BZ-8W27FL</b> <b>1536 BZ-8W27MD</b> <b>1536 BZ-8W27SP</b>	60° LED Flood Light 40° LED Medium Light 25° LED Spot Light	27G2SE-50	2700K	7.5w / 7.8VA	50w	Bronze	Cast Aluminum	Clear*
<b>1536 BZ-3WLEDL</b> <b>1536 BZ-3WLEDMD</b> <b>1536 BZ-3WLEDSP</b>	60° LED Flood Light 40° LED Medium Light 25° LED Spot Light	00G2SE-20	3000K	3w / 3.2VA	20w	Bronze	Cast Aluminum	Clear*
<b>1536 BZ-5WLEDL</b> <b>1536 BZ-5WLEDMD</b> <b>1536 BZ-5WLEDSP</b>	60° LED Flood Light 40° LED Medium Light 25° LED Spot Light	00G2SE-35	3000K	5w / 5.3VA	35w	Bronze	Cast Aluminum	Clear*
<b>1536 BZ-8WLEDL</b> <b>1536 BZ-8WLEDMD</b> <b>1536 BZ-8WLEDSP</b>	60° LED Flood Light 40° LED Medium Light 25° LED Spot Light	00G2SE-50	3000K	7.5w / 7.8VA	50w	Bronze	Cast Aluminum	Clear*

\*Optional performance lenses available, see page 75. A wiring kit and ground spike (0014 BZ, page 75) are supplied. Photometrics for 1536 spot lights are available on pages 78-79.

**LED MODULES**  
FOR 1536 SERIES  
SPOT LIGHTS

ITEM	DESCRIPTION	COLOR TEMP.	POWER SUPPLY REQUIREMENT	LUMEN OUTPUT	CRI	LIFESPAN (HOURS)	CONSTRUCTION
<b>27G2SE-20</b>	CREE 3 Watt LED	2700K	3w / 3.2VA	225	80	60,000	Cast Aluminum
<b>27G2SE-35</b>	CREE 5 Watt LED	2700K	5w / 5.3VA	325	80	60,000	Cast Aluminum
<b>27G2SE-50</b>	CREE 8 Watt LED	2700K	7.5w / 7.8VA	450	80	60,000	Cast Aluminum
<b>00G2SE-20</b>	CREE 3 Watt LED	3000K	3w / 3.2VA	250	80	60,000	Cast Aluminum
<b>00G2SE-35</b>	CREE 5 Watt LED	3000K	5w / 5.3VA	350	80	60,000	Cast Aluminum
<b>00G2SE-50</b>	CREE 8 Watt LED	3000K	7.5w / 7.8VA	475	80	60,000	Cast Aluminum

**LED LENS FOR**  
00G2SE & 27G2SE  
ENGINES

ITEM	DESCRIPTION	FINISH	BEAM SPREAD	CONSTRUCTION
<b>00G2FO-FLOOD</b>	Flood Spread Lens	Black	60°	Composite
<b>00G2FO-MEDIUM</b>	Medium Spread Lens	Gray	40°	Composite
<b>00G2FO-SPOT</b>	Spot Lens	White	25°	Composite

ACCENT LIGHTING

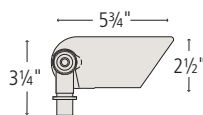

**1536 MZ**  
HARDY ISLAND™  
50W MR16 SPOT LIGHT  
2½" DIA. SHROUD  
5¾" L, ¾" H



**1536 BZ**  
50W MR16 SPOT LIGHT  
2½" DIA. SHROUD  
5¾" L, ¾" H

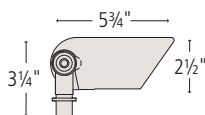

Lens View

**1536 BZ-DN**  
50W MR16 DOWN LIGHT  
2½" DIA. SHROUD  
5¾" L, ¾" H

ITEM	LAMP (NOT INCLUDED)	WATTAGE	BULB FOR LED CONVERSION (NOT INCLUDED)	FINISH	CONSTRUCTION	LENS
<b>1536 BZ</b>	MR16	up to 50w	MR16 LED	Bronze	Cast Aluminum	Clear
<b>1536 BZ-DN</b>	MR16	up to 50w	MR16 LED	Bronze	Cast Aluminum	Hex Louver*
<b>1536 MZ</b>	MR16	up to 50w	MR16 LED	Brass	Solid Brass	Clear

\*Includes Hex Louver lens for down light use only. Optional performance lenses available, see page 75. Photometrics for spot lights are based off bulb photometrics. See pages 80-83. See pages 80-81 for LED conversion lamps. A wiring kit and ground spike (0014 BZ, page 75) are supplied. 1536 BZ-DN mounting hardware not included. For accessories, see pages 74-75. For transformers, see pages 76-77.





**16501 MZ**  
**16501 MZ-27K60**  
 HARDY ISLAND™  
 SPOT LIGHT  
 1 3/4" DIA. SHROUD  
 4 3/4" L, 2 1/2" H



**DESIGN NOTE** ..... 16571 is oval in shape.

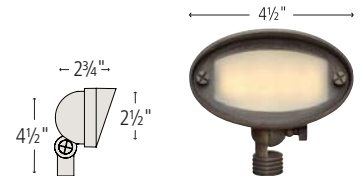

**16507 MZ**  
**16507 MZ-27K60**  
 HARDY ISLAND™  
 SPOT LIGHT & STEM  
 1 3/4" DIA. SHROUD  
 4 3/4" L, 26 1/2" H



**16571 MZ**  
**16571 MZ-LED**  
 HARDY ISLAND™ SMALL  
 WALL WASH FLOOD LIGHT  
 4 1/2" W, 2 1/2" H SHROUD  
 2 3/4" L, 4 1/2" H



LED ITEM	LED ENGINE (INCLUDED)	POWER SUPPLY REQUIREMENT	INCANDESCENT EQUIVALENCY	ITEM	LAMP (NOT INCLUDED)	WATTAGE	BULB FOR LED CONVERSION (NOT INCLUDED)	FINISH	CONSTRUCTION	LENS
<b>16501 MZ-27K60</b>	MR8LED60	2.5w	10w	<b>16501 MZ</b>	MR11	up to 20w	MR8LED60	Matte Bronze	Cast Brass	Clear
<b>16507 MZ-27K60</b>	MR8LED60	2.5w	10w	<b>16507 MZ</b>	MR11	up to 20w	MR8LED60	Matte Bronze	Cast Brass	Clear
<b>16571 MZ-LED</b>	NX3	3.8w / 5.7VA	25w	<b>16571 MZ</b>	T4	up to 35w		Matte Bronze	Cast Brass	Frosted

Photometrics for spot lights are based off bulb photometrics. See pages 80-83. See pages 80-81 for LED conversion lamps. A wiring kit and ground spike (0014 BZ, page 75) are supplied. For accessories, see pages 74-75. For transformers, see pages 76-77.

**PHOTOMETRICS (BASED ON VARIOUS MOUNTING DISTANCES AT 22° ANGLE)**

HORIZONTAL DISTANCE FROM CENTER		LED ITEM / ITEM	1'	2'	3'	4'	5'	6'	7'	8'
FOOT CANDLES	3' From Object	16571 MZ-LED	10.55	6.53	3.88	1.63	0.66	0.43	0.30	0.13
	6' From Object		6.96	4.31	2.56	1.08	0.44	0.28	0.20	0.09
	3' From Object	16571 MZ	8.44	5.22	3.10	1.30	0.53	0.34	0.24	0.10
	6' From Object		5.57	3.45	2.05	0.86	0.35	0.23	0.16	0.07

ACCENT LIGHTING

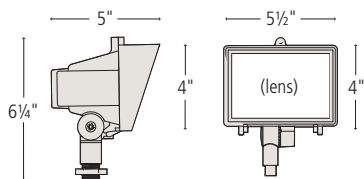

**1520 BZ**  
50W FLOOD LIGHT  
WITH CLEAR LENS  
5 1/2" W, 4" H SHROUD  
5" L, 6 1/4" H

**1521 BZ**  
50W FLOOD LIGHT  
WITH FROSTED LENS  
5 1/2" W, 4" H SHROUD  
5" L, 6 1/4" H

ITEM	LAMP (NOT INCLUDED)	WATTAGE	BULB FOR LED CONVERSION (NOT INCLUDED)	FINISH	CONSTRUCTION	LENS
<b>1520 BZ</b>	T4	up to 50w	T3 LED	Bronze	Cast Aluminum	Clear
<b>1521 BZ</b>	T4	up to 50w	T3 LED	Bronze	Cast Aluminum	Frosted

See pages 80-81 for LED conversion lamps. A wiring kit and ground spike (0014 BZ, page 75) are supplied. For accessories, see pages 74-75. For transformers, see pages 76-77.

**PHOTOMETRICS** (BASED ON VARIOUS MOUNTING DISTANCES AT 22° ANGLE USING T4 LAMP)

HORIZONTAL LIGHT SPREAD		ITEM	1'	2'	3'	4'	5'	6'	7'	8'	9'
FOOT CANDLES	3' From Object	1520 BZ	14.21	7.04	4.08	2.59	1.36	0.86	0.62	0.37	0.12
	6' From Object		4.87	4.58	3.59	2.71	1.82	1.13	0.74	0.64	0.54
	9' From Object		2.24	2.15	2.10	1.83	1.56	1.29	0.93	0.75	0.57
	3' From Object	1521 BZ	14.98	9.56	4.75	2.35	1.14	0.53	0.30	0.18	0.06
	6' From Object		4.48	3.90	3.27	2.51	1.90	1.32	0.93	0.68	0.44
	9' From Object		1.96	1.72	1.56	1.35	1.14	0.93	0.73	0.56	0.35



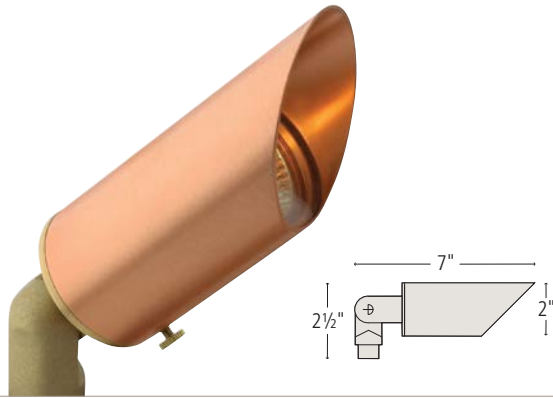

**1583 NC**  
50W MR16 COPPER SPOT LIGHT  
2" DIA. SHROUD  
5 3/4" L, 3 1/4" H



**1530 BZ**  
20W MR11 SPOT LIGHT  
1 3/4" DIA. SHROUD  
3 1/2" L, 2 1/2" H

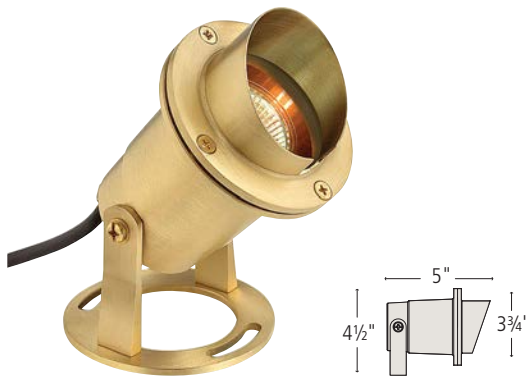

**1539 BS**  
50W MR16 BRASS SUBMERSIBLE  
POND LIGHT  
3 3/4" DIA. SHROUD  
5" L, 4 1/2" H



**1538 BZ**  
50W MR16 SPOT LIGHT  
3" DIA. SHROUD  
5 1/2" L, 4 1/4" H

ITEM	LAMP (NOT INCLUDED)	WATTAGE	BULB FOR LED CONVERSION (NOT INCLUDED)	FINISH	CONSTRUCTION	LENS
1530 BZ	MR11	up to 20w	MR8LED60	Bronze	Cast Aluminum	Clear
1538 BZ	MR16	up to 50w	MR16 LED	Bronze	PPS Composite	Clear*
1539 BS	MR16	up to 50w	MR16 LED	Brass	Solid Brass	Clear
1583 NC	MR16	up to 50w	MR16 LED	Natural Copper	Copper and Brass	Clear

\*Optional performance lenses available, see page 75. Photometrics for spot lights are based off bulb photometrics. See pages 80-83. See pages 80-81 for LED conversion lamps. A wiring kit and ground spike (0014 BZ, page 75) are supplied. For accessories, see pages 74-75. For transformers, see pages 76-77.

ACCENT LIGHTING

Well lights come with an easy installation, anti-corrosion PVC burial sleeve. (Can install into concrete)

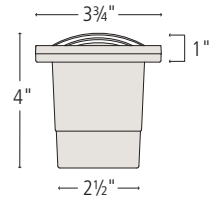
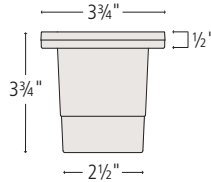

4 1/8" DIA., 5" H  
3" DIA. BASE

16701 MZ  
16701 MZ-27K25, 16701 MZ-27K60  
16701 MZ-3K25, 16701 MZ-3K60  
HARDY ISLAND™ FLAT TOP WELL LIGHT  
3 3/4" DIA., 3 3/4" H, 1/2" H TOP  
2 1/2" DIA. BASE



16704 MZ  
16704 MZ-27K25, 16704 MZ-27K60  
16704 MZ-3K25, 16704 MZ-3K60  
HARDY ISLAND™ GRILL TOP WELL LIGHT  
3 3/4" DIA., 4" H, 1" H TOP  
2 1/2" DIA. BASE



LED ITEM	LED LAMP (INCLUDED)	WATTAGE	INCANDESCENT EQUIVALENCY	ITEM	LAMP (NOT INCLUDED)	WATTAGE	BULB FOR LED CONVERSION (NOT INCLUDED)	FINISH	CONSTRUCTION	LENS
16701 MZ-27K25	25° 2700K MR16	2w	20w	16701 MZ	MR16	up to 20w	MR16 LED	Matte Bronze	Cast Brass	Clear
16701 MZ-27K60	60° 2700K MR16	2w	20w							
16701 MZ-3K25	25° 3000K MR16	2w	20w							
16701 MZ-3K60	60° 3000K MR16	2w	20w							
16704 MZ-27K25	25° 2700K MR16	2w	20w	16704 MZ	MR16	up to 20w	MR16 LED	Matte Bronze	Cast Brass	Clear
16704 MZ-27K60	60° 2700K MR16	2w	20w							
16704 MZ-3K25	25° 3000K MR16	2w	20w							
16704 MZ-3K60	60° 3000K MR16	2w	20w							

A wiring kit is supplied. Photometrics for spot lights are based off bulb photometrics. See pages 80-83. See pages 80-81 for LED conversion lamps. For accessories, see pages 74-75. For transformers, see pages 76-77.





**16710 MZ**  
**16710 MZ-3K60**  
 HARDY ISLAND™ DIRECTIONAL WELL LIGHT  
 3 3/4" DIA., 4 1/4" H, 1" H TOP  
 2 1/2" DIA. BASE



**16707 MZ**  
**16707 MZ-3K25**  
 HARDY ISLAND™ EYEBROW WELL LIGHT  
 3 3/4" DIA., 4 3/4" H, 1 1/2" H TOP  
 2 1/2" DIA. BASE



LED ITEM	LED LAMP (INCLUDED)	WATTAGE	INCANDESCENT EQUIVALENCY	ITEM	LAMP (NOT INCLUDED)	WATTAGE	BULB FOR LED CONVERSION (NOT INCLUDED)	FINISH	CONSTRUCTION	LENS
<b>16707 MZ-3K25</b>	25° 3000K MR16	2w	20w	<b>16707 MZ</b>	MR16	up to 20w	T3 LED	Matte Bronze	Cast Brass	Frosted
<b>16710 MZ-3K60</b>	60° 3000K MR16	2w	20w	<b>16710 MZ</b>	MR16	up to 20w	T3 LED	Matte Bronze	Cast Brass	Clear

A wiring kit is supplied. Photometrics for spot lights are based off bulb photometrics. See pages 80-83. See pages 80-81 for LED conversion lamps. For accessories, see pages 74-75. For transformers, see pages 76-77.

ACCENT LIGHTING

1599BS comes with an easy installation, anti-corrosion PVC burial sleeve.



3 3/4" DIA., 5" H

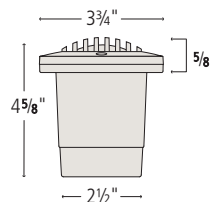

**1599 BS**  
50W MR16 BRASS WELL LIGHT  
3 3/4" DIA., 4 5/8" H, 5/8" H TOP  
2 1/2" DIA. BASE

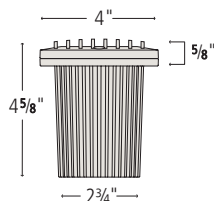

**1590 BZ**  
50W MR16 WELL LIGHT  
4" DIA., 4 5/8" H, 5/8" H TOP  
2 3/4" DIA. BASE

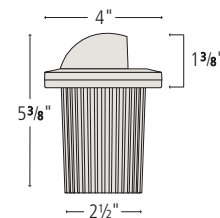

**1595 BZ**  
SHIELDED 50W MR16 WELL LIGHT  
4" DIA., 5 3/8" H, 1 3/8" H TOP  
2 1/2" DIA. BASE

ITEM	LAMP (NOT INCLUDED)	WATTAGE	BULB FOR LED CONVERSION (NOT INCLUDED)	FINISH	CONSTRUCTION	LENS
1590 BZ	MR16	up to 50w	MR16 LED	Bronze	Cast Aluminum	Clear Domed
1595 BZ	MR16	up to 50w	MR16 LED	Bronze	Cast Aluminum	Clear Domed
1599 BS	MR16	up to 50w	MR16 LED	Brass	Solid Brass with PVC Burial Sleeve	Clear

A wiring kit is supplied. Photometrics for spot lights are based off bulb photometrics. See pages 80-83. See pages 80-81 for LED conversion lamps. For accessories, see pages 74-75. For transformers, see pages 76-77.



# PATH / AREA LIGHTING



HARBOR 1561SK-LED, PAGE 35  
ANCHORAGE 1858DZ, HINKLEY FULL LINE CATALOG



---

# HIGH PERFORMANCE BOLLARDS

---

STREAMLINED DESIGN + DURABILITY + EFFICIENT LIGHT OUTPUT



COORDINATING OUTDOOR LANTERN  
COLLECTIONS ARE AVAILABLE FOR  
ALL BOLLARDS.

---

LUNA BOLLARD IN  
BRONZE AND TITANIUM,  
SEE PAGE 27





15609 BZ  
15609 BZ-LED  
LUNA™ BOLLARD  
3" DIA., 30" H



15609 TT  
15609 TT-LED  
LUNA™ BOLLARD  
3" DIA., 30" H



15607 KZ  
15607 KZ-LED  
SHELTER™ BOLLARD  
4" W, 30" H



15607 HE  
15607 HE-LED  
SHELTER™ BOLLARD  
4" W, 30" H



15607 BK  
15607 BK-LED  
SHELTER™ BOLLARD  
4" W, 30" H



LED ITEM	LED ENGINE (INCLUDED)	POWER SUPPLY REQUIREMENT	INCANDESCENT EQUIVALENCY	ITEM	LAMP (NOT INCLUDED)	MAX. WATTAGE	FINISH	CONSTRUCTION	LENS
15607 BK-LED	27G2SE-35	5w / 5.3VA	35w	15607 BK	MR16	35w	Black	Aluminum	Clear Acrylic Outside Cylinder Seedy Glass Inside Panel
15607 HE-LED	27G2SE-35	5w / 5.3VA	35w	15607 HE	MR16	35w	Hematite	Aluminum	Clear Acrylic Outside Cylinder Seedy Glass Inside Panel
15607 KZ-LED	27G2SE-35	5w / 5.3VA	35w	15607 KZ	MR16	35w	Buckeye Bronze	Aluminum	Clear Acrylic Outside Cylinder Seedy Glass Inside Panel
15609 BZ-LED	27G2SE-35	5w / 5.3VA	35w	15609 BZ	MR16	50w	Bronze	Aluminum	Etched Glass
15609 TT-LED	27G2SE-35	5w / 5.3VA	35w	15609 TT	MR16	50w	Titanium	Aluminum	Etched Glass

See pages 80-83 for lamping options (not included). A wiring kit and universal bollard mount with 2" diameter power post are supplied. For accessories, see pages 74-75. For transformers, see pages 76-77.



15601 BZ  
15601 BZ-LED  
ATLANTIS™  
ROUND BOLLARD  
3" DIA., 30" H



15601 TT  
15601 TT-LED  
ATLANTIS™  
ROUND BOLLARD  
3" DIA., 30" H



15602 BZ  
15602 BZ-LED  
ATLANTIS™  
SQUARE BOLLARD  
3" SQ., 30" H



15602 TT  
15602 TT-LED  
ATLANTIS™  
SQUARE BOLLARD  
3" SQ., 30" H



LED ITEM	LED ENGINE (INCLUDED)	POWER SUPPLY REQUIREMENT	INCANDESCENT EQUIVALENCY	ITEM	LAMP (NOT INCLUDED)	MAX. WATTAGE	FINISH	CONSTRUCTION	LENS
15601 BZ-LED	27G2SE-35	5w / 5.3VA	35w	15601 BZ	MR16	50w	Bronze	Aluminum	Etched Glass
15601 TT-LED	27G2SE-35	5w / 5.3VA	35w	15601 TT	MR16	50w	Titanium	Aluminum	Etched Glass
15602 BZ-LED	27G2SE-35	5w / 5.3VA	35w	15602 BZ	MR16	50w	Bronze	Aluminum	Etched Glass
15602 TT-LED	27G2SE-35	5w / 5.3VA	35w	15602 TT	MR16	50w	Titanium	Aluminum	Etched Glass

See pages 80-83 for lamping options (not included). A wiring kit and universal bollard mount with 2" diameter power post are supplied. For accessories, see pages 74-75. For transformers, see pages 76-77.





15604 BZ  
15604 BZ-LED  
SOLARA™ BOLLARD  
3" DIA., 30" H



15604 TT  
15604 TT-LED  
SOLARA™ BOLLARD  
3" DIA., 30" H



15612 BZ  
15612 BZ-LED  
DORIAN™ BOLLARD  
3" SQ., 30" H



15612 TT  
15612 TT-LED  
DORIAN™ BOLLARD  
3" SQ., 30" H



LED ITEM	LED ENGINE (INCLUDED)	POWER SUPPLY REQUIREMENT	INCANDESCENT EQUIVALENCY	ITEM	LAMP (NOT INCLUDED)	MAX. WATTAGE	FINISH	CONSTRUCTION	LENS
15604 BZ-LED	27G2SE-35	5w / 5.3VA	35w	15604 BZ	MR16	35w	Bronze	Aluminum	White Acrylic
15604 TT-LED	27G2SE-35	5w / 5.3VA	35w	15604 TT	MR16	35w	Titanium	Aluminum	White Acrylic
15612 BZ-LED	27G2SE-35	5w / 5.3VA	35w	15612 BZ	MR16	50w	Bronze	Aluminum	Etched Glass
15612 TT-LED	27G2SE-35	5w / 5.3VA	35w	15612 TT	MR16	50w	Titanium	Aluminum	Etched Glass

See pages 80-83 for lamping options (not included). A wiring kit and universal bollard mount with 2" diameter power post are supplied. For accessories, see pages 74-75. For transformers, see pages 76-77.

PATH | AREA



**15714 BZ**  
ARC™ PATH LIGHT  
1½" W, 23" H  
17" EXT.



**15711 BZ**  
ARC™ PATH LIGHT  
1½" W, 14½" H  
7¼" EXT.



**15714 TT**  
ARC™ PATH LIGHT  
1½" W, 23" H  
17" EXT.



**15711 TT**  
ARC™ PATH LIGHT  
1½" W, 14½" H  
7¼" EXT.



 LED ITEM	LED ENGINE (INCLUDED)	POWER SUPPLY REQUIREMENT	INCANDESCENT EQUIVALENCY	FINISH	CONSTRUCTION	LENS
<b>15711 BZ</b>	E5050LED	1.5w / 2.4VA	12w	Bronze	Aluminum	Etched Acrylic
<b>15711 TT</b>	E5050LED	1.5w / 2.4VA	12w	Titanium	Aluminum	Etched Acrylic
<b>15714 BZ</b>	E5050LED	1.5w / 2.4VA	12w	Bronze	Aluminum	Etched Acrylic
<b>15714 TT</b>	E5050LED	1.5w / 2.4VA	12w	Titanium	Aluminum	Etched Acrylic

A wiring kit and ground spike (0014BZ, page 75) are supplied. For accessories, see pages 74-75. For transformers, see pages 76-77.

**PHOTOMETRICS**

DISTANCE FROM LIGHT	LED ITEM	1'	2'	3'	4'	5'	6'	7'
FOOT CANDLES	15711 BZ, 15711 TT	11.40	5.53	2.20	1.18	0.74	0.48	0.13
	15714 BZ, 15714 TT	7.02	2.52	1.06	0.35	0.16	0.12	





**1548 BZ**  
**1548 BZ-LED**  
PIZA™ PATH LIGHT  
1¾" W, 15" H, 2¾" D  
10" EXT.



**1548 TT**  
**1548 TT-LED**  
PIZA™ PATH LIGHT  
1¾" W, 15" H, 2¾" D  
10" EXT.



**1502 BZ**  
**1502 BZ-LED**  
CONTEMPO™ PATH LIGHT  
8" W, 22" H



LED ITEM	LED ENGINE (INCLUDED)	POWER SUPPLY REQUIREMENT	INCANDESCENT EQUIVALENCY	ITEM	LAMP INCLUDED	WATTAGE	FINISH	CONSTRUCTION	GLASS LENS
<b>1502 BZ-LED</b>	NX3	3.8w / 5.7VA	25w	<b>1502 BZ</b>	921	18w	Bronze	Cast Aluminum	Etched Opal
<b>1548 BZ-LED</b>	NX3	3.8w / 5.7VA	25w	<b>1548 BZ</b>	921	18w	Bronze	Aluminum	Etched
<b>1548 TT-LED</b>	NX3	3.8w / 5.7VA	25w	<b>1548 TT</b>	921	18w	Titanium	Aluminum	Etched

See pages 80-81 for LED conversion lamps. A wiring kit and ground spike (0014BZ, page 75) are supplied. For accessories, see pages 74-75. For transformers, see pages 76-77.

**PHOTOMETRICS**

DISTANCE FROM LIGHT	LED ITEM	1'	2'	3'	4'	5'	6'	7'	8'	ITEM	1'	2'	3'	4'	5'
FOOT CANDLES	1502 BZ-LED	6.8	2.72	1.18	0.6	0.36	0.23	0.16	0.11	1502 BZ	4.03	3.03	0.81	0.12	
	1548 BZ-LED 1548 TT-LED	12.91	2.21	0.81	0.22	0.09				1548 BZ 1548 TT	6.76	2.25	0.88	0.49	0.10

PATH | AREA



**1518 CD-LED**  
ATLANTIS™ PATH LIGHT  
6½" W, 22" H, 1¼" EXT.



**1518 BZ**  
**1518 BZ-LED**  
ATLANTIS™ PATH LIGHT  
6½" W, 22" H, 1¼" EXT.



**1518 HE**  
**1518 HE-LED**  
ATLANTIS™ PATH LIGHT  
6½" W, 22" H, 1¼" EXT.

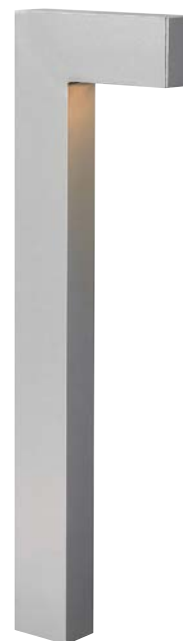

**1518 TT**  
**1518 TT-LED**  
ATLANTIS™ PATH LIGHT  
6½" W, 22" H, 1¼" EXT.



LED ITEM	LED ENGINE (INCLUDED)	POWER SUPPLY REQUIREMENT	INCANDESCENT EQUIVALENCY	ITEM	LAMP (INCLUDED)	WATTAGE	BULB FOR LED CONVERSION (NOT INCLUDED)	FINISH	CONSTRUCTION	GLASS LENS
<b>1518 BZ-LED</b>	NX3	3.8w / 5.7VA	25w	<b>1594 BZ</b>	T3	20w	T3 LED	Bronze	Aluminum	Etched
<b>1518 CD-LED</b>	NX3	3.8w / 5.7VA	25w					Cedar	Natural Cedar and Aluminum	Etched
<b>1518 HE-LED</b>	NX3	3.8w / 5.7VA	25w	<b>1594 HE</b>	T3	20w	T3 LED	Hematite	Aluminum	Etched
<b>1518 TT-LED</b>	NX3	3.8w / 5.7VA	25w	<b>1594 TT</b>	T3	20w	T3 LED	Titanium	Aluminum	Etched

See pages 80-81 for LED conversion lamps. A wiring kit and ground spike (0014BZ, page 75) are supplied. For accessories, see pages 74-75. For transformers, see pages 76-77.

**PHOTOMETRICS**

DISTANCE FROM LIGHT	LED ITEM	1'	2'	3'	4'	5'	ITEM	1'	2'	3'	4'
FOOT CANDLES	1518 BZ-LED, 1518 CD-LED, 1518 HE-LED, 1518 TT-LED	8.73	2.62	1.64	0.22	0.07	1518 BZ, 1518 HE, 1518 TT	5.00	1.13	0.27	0.16





**15014 BZ**  
ATLANTIS™ SMALL  
PATH LIGHT  
6½" W, 15" H, 1¼" EXT.



**15014 HE**  
ATLANTIS™ SMALL  
PATH LIGHT  
6½" W, 15" H, 1¼" EXT.

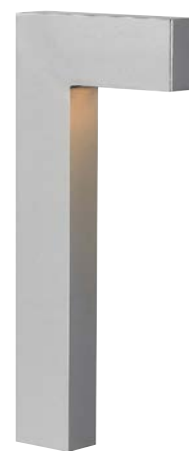

**15014 TT**  
ATLANTIS™ SMALL  
PATH LIGHT  
6½" W, 15" H, 1¼" EXT.



 LED ITEM	LED ENGINE (INCLUDED)	POWER SUPPLY REQUIREMENT	INCANDESCENT EQUIVALENCY	FINISH	CONSTRUCTION	GLASS LENS
<b>15014 BZ</b>	NX3	3.8w / 5.7VA	25w	Bronze	Aluminum	Etched
<b>15014 HE</b>	NX3	3.8w / 5.7VA	25w	Hematite	Aluminum	Etched
<b>15014 TT</b>	NX3	3.8w / 5.7VA	25w	Titanium	Aluminum	Etched

A wiring kit and ground spike (0014BZ, page 75) are supplied. For accessories, see pages 74-75. For transformers, see pages 76-77.

**PHOTOMETRICS**

DISTANCE FROM LIGHT	LED ITEM	1'	2'	3'	4'	5'
FOOT CANDLES	15014 BZ, 15014 HE, 15014 TT	16.20	3.50	1.30	0.11	0.05

PATH | AREA



1547 HE  
SHELTER™ PATH LIGHT  
4½" W, 22¼" H



1547 KZ  
SHELTER™ PATH LIGHT  
4½" W, 22¼" H



1579 MT  
SATURN™ PATH LIGHT  
4½" W, 22¼" H



1579 SS  
SATURN™ PATH LIGHT  
4½" W, 22¼" H

ITEM	LAMP (INCLUDED)	WATTAGE	BULB FOR LED CONVERSION (NOT INCLUDED)	FINISH	CONSTRUCTION	GLASS
1547 HE	921	18w	T5 LED	Hematite	Aluminum	Clear Seedy
1547 KZ	921	18w	T5 LED	Bronze	Aluminum	Clear Seedy
1579 MT	921	18w	T5 LED	Metro Bronze	Solid Brass	Etched Opal
1579 SS	921	18w	T5 LED	Stainless Steel	Solid Brass	Etched Opal

See pages 80-81 for LED conversion lamps. A wiring kit and ground spike (0014BZ, page 75) are supplied. For accessories, see pages 74-75. For transformers, see pages 76-77.

PHOTOMETRICS

DISTANCE FROM LIGHT	ITEM	1'	2'	3'	4'	5'	6'
FOOT CANDLES	1547 HE, 1547 KZ	4.90	3.35	1.31	0.74	0.33	.060
	1579 MT, 1579 SS	0.89	0.85	0.33	0.11	0.02	



1560 AR  
HARBOR™ PATH LIGHT  
7" W, 24" H

1561 AR  
1561 AR-LED  
HARBOR™ PATH LIGHT  
7½" W, 21" H



1561 SK  
1561 SK-LED  
HARBOR™ PATH LIGHT  
7½" W, 21" H



1561 TT  
1561 TT-LED  
HARBOR™ PATH LIGHT  
7½" W, 21" H



LED ITEM	LED ENGINE (INCLUDED)	POWER SUPPLY REQUIREMENT	INCANDESCENT EQUIVALENCY	ITEM	LAMP (INCLUDED)	WATTAGE	BULB FOR LED CONVERSION (NOT INCLUDED)	FINISH	CONSTRUCTION	GLASS OR LENS
				1560 AR	921	18w	T5 LED	Anchor Bronze	Aluminum	Etched Amber Bound Seedy
1561 AR-LED	NX3	3.8w / 5.7VA	25w	1561 AR	921	18w	T5 LED	Anchor Bronze	Aluminum	Etched Lens
1561 SK-LED	NX3	3.8w / 5.7VA	25w	1561 SK	921	18w	T5 LED	Satin Black	Aluminum	Etched Lens
1561 TT-LED	NX3	3.8w / 5.7VA	25w	1561 TT	921	18w	T5 LED	Titanium	Aluminum	Etched Lens

See pages 80-81 for LED conversion lamps. A wiring kit and ground spike (0014BZ, page 75) are supplied. For accessories, see pages 74-75. For transformers, see pages 76-77.

PHOTOMETRICS

DISTANCE FROM LIGHT	LED ITEM	1'	2'	3'	4'	5'	6'	7'	ITEM	1'	2'	3'	4'	5'	6'	7'
FOOT CANDLES									1560 AR	4.96	2.22	0.50	0.28	0.17	0.09	0.05
	1561 AR-LED, 1561 SK-LED, 1561 TT-LED	19.92	4.84	1.26	0.43	0.16	0.07	0.04	1561 AR, 1561 SK, 1561 TT	8.90	2.78	0.78	0.36	0.07	0.03	



PATH | AREA



**1544 BK**  
**1544 BK-LED**  
ELLIPSE™ PATH LIGHT  
5¾" W, 14½"-20½" H



**1544 SC**  
**1544 SC-LED**  
ELLIPSE™ PATH LIGHT  
5¾" W, 14½"-20½" H



**1573 BK**  
**1573 BK-LED**  
SAUCER™ PATH LIGHT  
8" W, 15½"-21½" H



**1573 SC**  
**1573 SC-LED**  
SAUCER™ PATH LIGHT  
8" W, 15½"-21½" H



LED ITEM	LED ENGINE (INCLUDED)	POWER SUPPLY REQUIREMENT	INCANDESCENT EQUIVALENCY	ITEM	LAMP (INCLUDED)	WATTAGE	BULB FOR LED CONVERSION (NOT INCLUDED)	FINISH	CONSTRUCTION
<b>1544 BK-LED</b>	IPL-30	2.3w / 3.9VA	12w	<b>1544 BK</b>	912	12w	T5 LED	Black	Cast Aluminum
<b>1544 SC-LED</b>	IPL-30	2.3w / 3.9VA	12w	<b>1544 SC</b>	912	12w	T5 LED	Southern Clay	Cast Aluminum
<b>1573 BK-LED</b>	IPL-30	2.3w / 3.9VA	12w	<b>1573 BK</b>	912	12w	T5 LED	Black	Cast Aluminum
<b>1573 SC-LED</b>	IPL-30	2.3w / 3.9VA	12w	<b>1573 SC</b>	912	12w	T5 LED	Southern Clay	Cast Aluminum

See pages 80-81 for LED conversion lamps. A wiring kit and ground spike (0014BZ, page 75) are supplied. For accessories, see pages 74-75. For transformers, see pages 76-77.

PHOTOMETRICS

DISTANCE FROM LIGHT	LED ITEM	1'	2'	3'	4'	5'	6'	ITEM	1'	2'	3'	4'	5'	6'	7'
FOOT CANDLES	1544 BK-LED 1544 SC-LED	3.64	1.18	0.44	0.28	0.13	0.06	1544 BK 1544 SC	3.88	1.13	0.38	0.16	0.10	0.03	
	1573 BK-LED 1573 SC-LED	3.62	1.19	0.43	0.22	0.16	0.07	1573 BK 1573 SC	4.00	1.26	0.61	0.38	0.20	0.09	0.03



1558 BK/SC: 180° swiveling head allows for maximum flexibility, and can be used for wall wash applications.

**FORM & FUNCTION**

1570FS: decorative 120° rotating head allows for flexible precision to illuminate a variety of spaces.

1558 SC  
1558 SC-LED  
SHELL™ PATH LIGHT  
6" W, 15½"-21½" H



1558 BK  
1558 BK-LED  
SHELL™ PATH LIGHT  
6" W, 15½"-21½" H



1570 FS  
LEAF™ PATH LIGHT  
7" W, 20" H, 11" EXT.



LED ITEM	LED ENGINE (INCLUDED)	POWER SUPPLY REQUIREMENT	INCANDESCENT EQUIVALENCY	ITEM	LAMP (INCLUDED)	WATTAGE	BULB FOR LED CONVERSION (NOT INCLUDED)	FINISH	CONSTRUCTION	GLASS LENS
1558 BK-LED	IPL-30	2.3w / 3.9VA	12w	1558 BK	912	12w	T5 LED	Black	Cast Aluminum	Frosted
1558 SC-LED	IPL-30	2.3w / 3.9VA	12w	1558 SC	912	12w	T5 LED	Southern Clay	Cast Aluminum	Frosted
1570 FS	NX3	3.8w / 5.7VA	25w					Forest	Aluminum	Frosted

See pages 80-81 for LED conversion lamps. A wiring kit and ground spike (0014BZ, page 75) are supplied. For accessories, see pages 74-75. For transformers, see pages 76-77.

**PHOTOMETRICS**

DISTANCE FROM LIGHT	LED ITEM	1'	2'	3'	4'	5'	ITEM	1'	2'	3'	4'	5'	6'
FOOT CANDLES	1558 BK-LED 1558 SC-LED	14.73	4.84	1.13	0.31	0.10	1558 BK 1558 SC	9.48	2.99	0.58	0.16	0.05	0.01
	1570 FS	12.36	1.67	0.13	0.07	0.03							

DESIGNED for  
**DURABILITY**

Hardy Island path lights are backed by a lifetime warranty, ensuring long-lasting performance in any environment.



**16007 MZ**  
16007 MZ-LED  
HARDY ISLAND™  
LARGE HAMMERED  
PATH LIGHT  
6¾" W, 23½" H



**16010 MZ**  
16010 MZ-LED  
HARDY ISLAND™  
SMALL HAMMERED  
PATH LIGHT  
6¾" W, 15½" H



**16004 MZ**  
16004 MZ-LED  
HARDY ISLAND™  
SMALL TRADITIONAL  
PATH LIGHT  
7" W, 15½" H



**16050 MZ**  
HARDY ISLAND™  
SMALL STANDARD  
PATH LIGHT  
4½" W, 15" H



**16055 MZ**  
HARDY ISLAND™  
LARGE STANDARD  
PATH LIGHT  
4½" W, 15" H



LED ITEM	LED ENGINE (INCLUDED)	POWER SUPPLY REQUIREMENT	INCANDESCENT EQUIVALENCY	ITEM	LAMP (INCLUDED)	WATTAGE	BULB FOR LED CONVERSION (NOT INCLUDED)	FINISH	CONSTRUCTION	GLASS OR LENS
<b>16004 MZ-LED</b>	IPL-30	2.3w / 3.9VA	20w	<b>16004 MZ</b>	T3	20w	T3 LED	Matte Bronze	Cast Brass	Clear Dome
<b>16007 MZ-LED</b>	IPL-30	2.3w / 3.9VA	20w	<b>16007 MZ</b>	T3	20w	T3 LED	Matte Bronze	Cast Brass	Clear Dome
<b>16010 MZ-LED</b>	IPL-30	2.3w / 3.9VA	20w	<b>16010 MZ</b>	T3	20w	T3 LED	Matte Bronze	Cast Brass	Clear Dome
				<b>16050 MZ</b>	T3	20w	T3 LED	Matte Bronze	Cast Brass	Frosted Acrylic
				<b>16055 MZ</b>	T3	20w	T3 LED	Matte Bronze	Cast Brass	Frosted Acrylic

See pages 80-81 for LED conversion lamps. A wiring kit and ground spike (0014BZ, page 75) are supplied. For accessories, see pages 74-75. For transformers, see pages 76-77.

**PHOTOMETRICS**

DISTANCE FROM LIGHT	LED ITEM	1'	2'	3'	4'	5'	6'	7'	8'	ITEM	1'	2'	3'	4'	5'	6'	7'
FOOT CANDLES	16004 MZ-LED	4.78	2.88	1.33	0.59	0.18	0.11	0.05		16004 MZ	14.01	3.91	1.43	0.67	0.29	0.10	
	16007 MZ-LED	5.08	2.41	1.45	0.64	0.35	0.19	0.11	0.08	16007 MZ	9.62	3.21	1.38	0.72	0.46	0.33	0.20
	16010 MZ-LED	4.81	3.01	1.21	0.67	0.23	0.14	0.06		16010 MZ	14.37	3.83	1.28	0.43	0.09		
										16050 MZ	13.03	4.10	0.82	0.09			
										16055 MZ	12.97	6.69	2.82	1.05	0.56	0.40	0.24





16024 MZ  
16024 MZ-LED  
HARDY ISLAND™  
LARGE HEXAGON  
PATH LIGHT  
9½" W, 23½" H

16012 MZ  
16012 MZ-LED  
HARDY ISLAND™  
ROUND SIDE MOUNT  
PATH LIGHT  
7½" W, 18½" H

16016 MZ  
16016 MZ-LED  
HARDY ISLAND™  
MINI CLASSIC  
PATH LIGHT  
5¼" W, 15½" H

16022 MZ  
16022 MZ-LED  
HARDY ISLAND™  
SMALL CLASSIC  
PATH LIGHT  
8" W, 16" H

16019 MZ  
16019 MZ-LED  
HARDY ISLAND™  
LARGE CLASSIC  
PATH LIGHT  
8" W, 24" H

LED ITEM	LED ENGINE (INCLUDED)	POWER SUPPLY REQUIREMENT	INCANDESCENT EQUIVALENCY	ITEM	LAMP (INCLUDED)	WATTAGE	BULB FOR LED CONVERSION (NOT INCLUDED)	FINISH	CONSTRUCTION	GLASS OR LENS
16012 MZ-LED	NX3	3.8w / 5.7VA	25w	16012 MZ	T3	20w	T3 LED	Matte Bronze	Cast Brass	Etched Lens
16016 MZ-LED	IPL-30	2.3w / 3.9VA	20w	16016 MZ	T3	20w	T3 LED	Matte Bronze	Cast Brass	Clear Dome
16019 MZ-LED	IPL-30	2.3w / 3.9VA	20w	16019 MZ	T3	20w	T3 LED	Matte Bronze	Cast Brass	Clear Dome
16022 MZ-LED	IPL-30	2.3w / 3.9VA	20w	16022 MZ	T3	20w	T3 LED	Matte Bronze	Cast Brass	Clear Dome
16024 MZ-LED	IPL-30	2.3w / 3.9VA	20w	16024 MZ	T3	20w	T3 LED	Matte Bronze	Cast Brass	Clear Dome

See pages 80-81 for LED conversion lamps. A wiring kit and ground spike (0014BZ, page 75) are supplied. For accessories, see pages 74-75. For transformers, see pages 76-77.

PHOTOMETRICS

DISTANCE FROM LIGHT	LED ITEM	1'	2'	3'	4'	5'	6'	7'	8'	ITEM	1'	2'	3'	4'	5'	6'	7'
FOOT CANDLES	16012 MZ-LED	5.08	2.65	1.38	0.66	0.29	0.19	0.10		16012 MZ	10.94	3.76	1.92	0.85	0.54	0.41	0.12
	16016 MZ-LED	4.98	2.88	1.38	0.53	0.17	0.11			16016 MZ	13.44	3.46	1.00	0.23	0.08		
	16019 MZ-LED	5.08	2.44	1.40	0.07	0.38	0.20	0.12		16019 MZ	9.10	3.13	1.32	0.77	0.49	0.35	0.21
	16022 MZ-LED	4.96	3.10	1.25	0.69	0.23	0.15			16022 MZ	14.91	3.97	1.32	0.44	0.26		
	16024 MZ-LED	5.51	2.65	1.40	0.67	0.40	0.25	0.13	0.11	16024 MZ	10.81	5.42	1.58	0.85	0.54	0.41	0.12

PATH | AREA



1555 CB  
BRATENAHL™ PATH LIGHT  
8" W, 22" H



1527 CB  
BRATENAHL™ PATH LIGHT  
8" W, 22" H



1540 CB  
MONTICELLO™ PATH LIGHT  
8" W, 22" H



ITEM	LAMP (INCLUDED)	WATTAGE	BULB FOR LED CONVERSION (NOT INCLUDED)	FINISH	CONSTRUCTION	GLASS
1527 CB	921	18w	T5 LED	Copper Bronze	Solid Brass	Etched Shield*
1540 CB	921	18w	T5 LED	Copper Bronze	Solid Brass	Etched Shield*
1555 CB	921	18w	T5 LED	Copper Bronze	Solid Brass	Clear Seedy

\*Equipped with lamp shield. See pages 80-81 for LED conversion lamps. A wiring kit and ground spike (0014BZ, page 75) are supplied. For accessories, see pages 74-75. For transformers, see pages 76-77.

PHOTOMETRICS

DISTANCE FROM LIGHT	ITEM	1'	2'	3'	4'	5'	6'	7'
FOOT CANDLES	1527 CB	4.27	2.59	1.13	.50	0.24	0.08	0.03
	1540 CB	5.16	2.90	1.26	0.58	0.22	0.13	0.04
	1555 CB	3.15	2.51	0.97	0.58	0.32	0.19	0.06



1593 OB  
BOLLA™ PATH LIGHT  
8" W, 22" H



1552 SZ  
PALM™ PATH LIGHT  
6¾" W, 22" H



1403 OC  
ESSENCE™ HAMMERED  
PATH LIGHT  
6" W, 16¾" H



ITEM	LAMP (INCLUDED)	WATTAGE	BULB FOR LED CONVERSION (NOT INCLUDED)	FINISH	CONSTRUCTION	GLASS
1403 OC	921	18w	T5 LED	Old Copper	Solid Brass	Frosted Shield*
1552 SZ	921	18w	T5 LED	Sienna Bronze	Copper & Brass	
1593 OB	921	18w	T5 LED	Olde Bronze	Solid Brass	Etched Shield*

\*Equipped with lamp shield. See pages 80-81 for LED conversion lamps. A wiring kit and ground spike (0014BZ, page 75) are supplied. For accessories, see pages 74-75. For transformers, see pages 76-77.

**PHOTOMETRICS**

DISTANCE FROM LIGHT	ITEM	1'	2'	3'	4'	5'	6'
FOOT CANDLES	1403 OC	12.34	4.73	0.28	0.09	0.03	0.01
	1552 SZ	7.30	4.31	1.67	0.62	0.19	0.09
	1593 OB	8.85	3.46	0.59	0.25	0.06	0.02



## "LIGHTING EVOKES MOOD AND EMOTION

UNLIKE ANY OTHER ELEMENT IN DESIGN, AND ITS ABILITY  
TO TRANSFORM OUR SPACES IS TRULY MAGICAL."

LISA MCDENNON | LISA MCDENNON DESIGN  
LAGUNA BEACH, CA







**1513 MB**  
**RALEY™ PATH LIGHT**  
 5½" W, 22" H



**1515 RB**  
**TRELIS™ PATH LIGHT**  
 7¼" W, 30" H



**1529 CB**  
**PLANTATION™ PATH LIGHT**  
 3¾" W, 22" H



**1567 RY**  
**MIRABELLA™ PATH LIGHT**  
 8" W, 22" H

ITEM	LAMP (INCLUDED)	WATTAGE	BULB FOR LED CONVERSION (NOT INCLUDED)	FINISH	CONSTRUCTION	GLASS
<b>1513 MB</b>	921	18w	T5 LED	Museum Black	Cast Aluminum	Clear Waterglass
<b>1515 RB</b>	921	18w	T5 LED	Regency Bronze	Cast Aluminum	Clear Seedy
<b>1529 CB</b>	921	18w	T5 LED	Copper Bronze	Cast Brass	Clear Optic
<b>1567 RY</b>	921	18w	T5 LED	Royal Bronze	Brass & Aluminum	Light Amber Nuage*

\*Equipped with lamp shield. See pages 80-81 for LED conversion lamps. A wiring kit and ground spike (0014BZ, page 75) are supplied. For accessories, see pages 74-75. For transformers, see pages 76-77.

**PHOTOMETRICS**

DISTANCE FROM LIGHT	ITEM	1'	2'	3'	4'	5'	6'	7'	8'
FOOT CANDLES	1513 MB	1.66	0.46	0.36	0.26	0.16	0.06		
	1515 RB	7.85	2.98	0.75	0.66	0.47	0.26	0.16	0.09
	1529 CB	1.68	1.46	0.79	0.41	0.26	0.07		
	1567 RY	5.01	2.35	1.06	0.51	0.24	0.14	0.10	0.05

PATH | AREA



**1516 MR**  
LEDGEWOOD™ PATH LIGHT  
5" W, 22" H



**1508 CB**  
IVY™ PATH LIGHT  
8" W, 26" H



**1554 SZ**  
ASPEN™ PATH LIGHT  
9½" W, 22" H



**1568 RB**  
SQUIRREL™ PATH LIGHT  
6½" W, 22" H

ITEM	LAMP (INCLUDED)	WATTAGE	BULB FOR LED CONVERSION (NOT INCLUDED)	FINISH	CONSTRUCTION	GLASS
<b>1508 CB</b>	921	18w	00T5-LED	Copper Bronze	Solid Brass	Light Amber*
<b>1516 MR</b>	921	18w	00T5-LED	Museum Bronze	Cast Aluminum	Champagne Inside Etched
<b>1554 SZ</b>	921	18w	00T5-LED	Sienna Bronze	Solid Brass	Honey Art
<b>1568 RB</b>	921	18w	00T5-LED	Regency Bronze	Solid Brass	Champagne Marble

\*Equipped with lamp shield. See pages 80-81 for LED conversion lamps. A wiring kit and ground spike (0014BZ, page 75) are supplied. For accessories, see pages 74-75. For transformers, see pages 76-77.

PHOTOMETRICS

DISTANCE FROM LIGHT	ITEM	1'	2'	3'	4'	5'	6'	7'
FOOT CANDLES	1508 CB	8.09	3.49	1.62	0.77	0.26	0.09	
	1516 MR	0.83	1.07	0.69	0.60	0.26	0.12	0.07
	1554 SZ	7.88	1.01	0.37	0.16	0.10	0.05	
	1568 RB	4.96	2.33	1.05	0.51	0.24	0.15	0.05



# THE NEXUS™ COLLECTION



COMPATIBLE WITH ANY 12VAC LANDSCAPE  
TRANSFORMER

9VAC-15VAC OR VDC INPUT RANGE

VARIETY OF ASSEMBLY OPTIONS WITH  
3", 6", 12", 18" AND 24" STEMS

FLEXIBLE PERFORMANCE CAPABILITIES  
WITH LINEAR HEAD THAT ROTATES 360°

75% LESS ENERGY USE THAN INCANDESCENT

NEXUS FIXTURES ARE FULLY DIMMABLE

2700K COLOR TEMPERATURE

LONG LIFE : 40,000 HOURS

NEXUS 15476BZ, PAGE 46, SURF 2355SS, HINKLEY FULL LINE CATALOG.



NEXUS™



**DESIGN NOTE** Linear heads rotate 360° for precise adjustments

**15476 BZ**  
LARGE T-CONNECTOR  
32" W, 2½" H, 1" TUBE DIA.  
SHOWN WITH 18" STEM



**15472 BZ**  
SMALL T-CONNECTOR  
19½" W, 2½" H, 1" TUBE DIA.  
SHOWN WITH 6" STEM

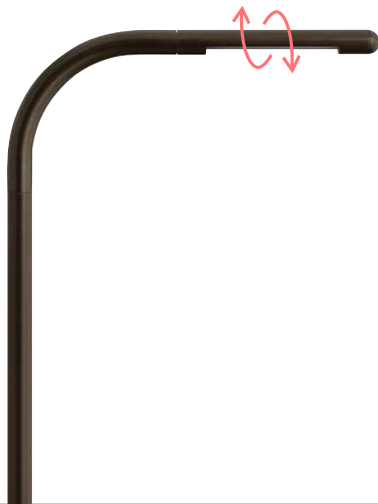

**15471 BZ**  
SMALL PATH LIGHT  
14½" W, 7" H, 1" TUBE DIA.  
INCLUDES 24" STEM



**NEXUS™ STEMS**

- (3") 15903 BZ/SW
- (6") 15906 BZ/SW
- (12") 15912 BZ
- (18") 15918 BZ
- (24") 15924 BZ

**NEXUS™ PATH LIGHTS AND T-CONNECTORS FULFILL A WIDE RANGE OF APPLICATIONS WHEN USED WITH 3", 6", 12", 18" AND 24" STEMS**

LED ITEM	LED ENGINE (INCLUDED)	POWER SUPPLY REQUIREMENT	INCANDESCENT EQUIVALENCY	FINISH	CONSTRUCTION	LENS
<b>15471 BZ</b>	NX6	3.8w / 5.7VA	25w	Bronze	Aluminum	Polycarbonate
<b>15472 BZ</b>	(2) NX6	7.6w / 11.4VA	50w	Bronze	Aluminum	Polycarbonate
<b>15476 BZ</b>	(2) NX12	14.6w / 21.6VA	100w	Bronze	Aluminum	Polycarbonate

A wiring kit and ground spike are supplied. For accessories, see pages 74-75. For transformers, see pages 76-77.



15452 BZ  
LARGE T SIGN LIGHT  
31½" W, 5" H, 1" TUBE DIA.



15450 BZ  
SMALL T SIGN LIGHT  
19½" W, 5" H, 1" TUBE DIA.



15452 SW  
LARGE T SIGN LIGHT  
31½" W, 5" H, 1" TUBE DIA.



15450 SW  
SMALL T SIGN LIGHT  
19½" W, 5" H, 1" TUBE DIA.



A collection of components for the sign light kit: an electronic transformer, a junction box cover, a light engine, and two stems (3" and 6").

THE 120V **SIGN LIGHT KIT**

ELECTRONIC TRANSFORMER + JUNCTION BOX COVER  
+ LIGHT ENGINE + 3" AND 6" STEM

LED ITEM	LED ENGINE (INCLUDED)	ELECTRONIC TRANSFORMER	INCANDESCENT EQUIVALENCY	FINISH	CONSTRUCTION	LENS
15450 BZ	(2) NX6	9w	50w	Bronze	Aluminum	Polycarbonate
15450 SW	(2) NX6	9w	50w	Satin White	Aluminum	Polycarbonate
15452 BZ	(2) NX12	14.6w	100w	Bronze	Aluminum	Polycarbonate
15452 SW	(2) NX12	14.6w	100w	Satin White	Aluminum	Polycarbonate

For accessories, see pages 74-75.





**DESIGN  
NOTE**

Linear head rotates 360°  
for precise adjustments

**15442 BZ**  
LARGE HARDSCAPE DECK LIGHT  
15½" W, 1⅞" H  
3½" BRACKET DEPTH



**15442 SW**  
LARGE HARDSCAPE DECK LIGHT  
15½" W, 1⅞" H  
3½" BRACKET DEPTH



**15440 SW**  
SMALL HARDSCAPE DECK LIGHT  
9½" W, 1⅞" H  
3½" BRACKET DEPTH



**15440 BZ**  
SMALL HARDSCAPE DECK LIGHT  
9½" W, 1⅞" H  
3½" BRACKET DEPTH



**HARDSCAPE SPACING RECOMMENDATIONS**

MOUNTING HEIGHT	15440BZ/SW CENTER TO CENTER	15442BZ/SW CENTER TO CENTER
1'	2'	3'
2'	3'	4'
3'	4'	6'



**NEXUS** HARDSCAPE LIGHTS ARE PROVIDED  
WITH A REMOVABLE MOUNTING PLATE

LED ITEM	LED ENGINE (INCLUDED)	POWER SUPPLY REQUIREMENT	INCANDESCENT EQUIVALENCY	FINISH	CONSTRUCTION	LENS
<b>15440 BZ</b>	NX6	3.8w / 5.7VA	25w	Bronze	Aluminum	Polycarbonate
<b>15440 SW</b>	NX6	3.8w / 5.7VA	25w	Satin White	Aluminum	Polycarbonate
<b>15442 BZ</b>	NX12	7.3w / 10.8VA	50w	Bronze	Aluminum	Polycarbonate
<b>15442 SW</b>	NX12	7.3w / 10.8VA	50w	Satin White	Aluminum	Polycarbonate

A wiring kit and ground spike are supplied. For accessories, see pages 74-75. For transformers, see pages 76-77.



# DECK / STEP / PATIO

## LIGHTING



PHOTOGRAPHY BY PETER FRANK EDWARDS | COASTAL LIVING  
1594 BZ-LED, PAGE 57





15446 BZ  
SHOWN WITHOUT MOUNTING PLATE



15446 BZ  
15446 BZ-10  
5" L, 3" W, 3/4" H  
2 1/8" BRACKET DEPTH



# NUVI HARDSCAPE

- + Exceptional 12v LED horizontal illumination due to innovative composite optic technology
- + Durable, solid vinyl alloy construction tested for 20 years of color life
- + Diverse range of mounting opportunities
- + Easy and efficient installation: fewer fixtures illuminate a more extensive area
- + Suitable for harsh environments
- + ETL rated for indoor/outdoor use
- + Available as single items or packages of 10

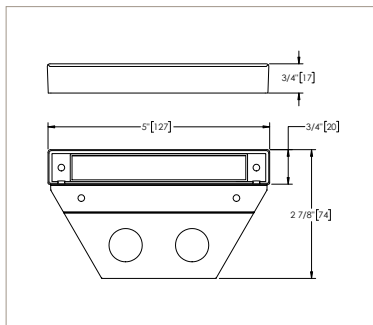

15446 ST  
15446 ST-10  
5" L, 3" W, 3/4" H  
2 1/8" BRACKET DEPTH



15446 TT  
15446 TT-10  
5" L, 3" W, 3/4" H  
2 1/8" BRACKET DEPTH



LED ITEM	LED ENGINE (INCLUDED)	POWER SUPPLY REQUIREMENT	INCANDESCENT EQUIVALENCY	FINISH	CONSTRUCTION	LENS
15446 BZ, 15446 BZ-10	NX4	1.9w / 2.8VA	15w	Bronze	Vinyl Alloy	Composite PC
15446 ST, 15446 ST-10	NX4	1.9w / 2.8VA	15w	Sandstone	Vinyl Alloy	Composite PC
15446 TT, 15446 TT-10	NX4	1.9w / 2.8VA	15w	Titanium	Vinyl Alloy	Composite PC

Nuvi Hardscape carries a 10 year limited warranty. For accessories, see pages 74-75. For transformers, see pages 76-77.

**PHOTOMETRICS (BASED ON VARIOUS MOUNTING HEIGHTS)**

DISTANCE FROM LIGHT		LED ITEM	1'	2'	3'	4'
FOOT CANDLES	12" Mounting	15446 BZ 15446 ST	20.42	10.33	5.35	2.91
	24" Mounting		4.80	4.45	3.61	2.02
	36" Mounting	15446 TT	2.15	2.24	2.03	1.31
	48" Mounting		1.01	1.31	1.26	.82

**HARDSCAPE SPACING RECOMMENDATIONS**

MOUNTING HEIGHT	15446 BZ/ST/TT CENTER TO CENTER
12"	24"
24"	30"
36"	36"
48"	48"



# LUNA STEP LIGHT

- + FULLY DIMMABLE
- + FITS STANDARD GANG JUNCTION BOX
- + 3.8W POWER CONSUMPTION
- + DIE CAST ZINC ALUMINUM ALLOY

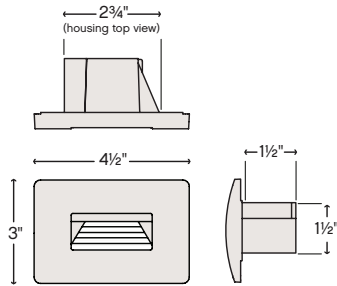

**15508 SW**  
12V LUNA™ STEP LIGHT  
4 1/2" W, 3" H



**15508 MZ**  
12V LUNA™ STEP LIGHT  
4 1/2" W, 3" H



**15508 BZ**  
12V LUNA™ STEP LIGHT  
4 1/2" W, 3" H



**15508 TT**  
12V LUNA™ STEP LIGHT  
4 1/2" W, 3" H



LED ITEM	LED ENGINE (INCLUDED)	POWER SUPPLY REQUIREMENT	INCANDESCENT EQUIVALENCY	FINISH	CONSTRUCTION
<b>15508 BZ</b>	LS-4	3.8w / 6.5VA	20w	Bronze	Zinc Aluminum Alloy
<b>15508 MZ</b>	LS-4	3.8w / 6.5VA	20w	Matte Bronze	Forged Brass Face Plate
<b>15508 SW</b>	LS-4	3.8w / 6.5VA	20w	Satin White	Zinc Aluminum Alloy
<b>15508 TT</b>	LS-4	3.8w / 6.5VA	20w	Titanium	Zinc Aluminum Alloy

For accessories, see pages 74-75. For transformers, see pages 76-77.

**PHOTOMETRICS (BASED ON VARIOUS MOUNTING HEIGHTS)**

DISTANCE FROM LIGHT		LED ITEM	1'	2'	3'	4'	5'	6'	7'	8'	
FOOT CANDLES	8" Mounting	15508 BZ	3.58	0.71	0.2						
	16" Mounting			0.86	0.38	0.15					
	30" Mounting				0.27	0.24	0.13				
	8" Mounting	15508 MZ	3.58	0.71	0.20						
	16" Mounting			0.86	0.38	0.15					
	30" Mounting				0.27	0.24	0.13				
	8" Mounting	15508 SW	7	2.19	0.97	0.57	0.37	0.26	0.19	0.14	
	16" Mounting			0.66	0.158	0.85	0.5	0.32	0.23	0.16	0.12
	30" Mounting				0.32	0.52	0.43	0.3	0.23	0.16	0.12
	8" Mounting	15508 TT	4.5	1.8	0.45	0.25	0.15	0.11			
	16" Mounting				1.03	0.54	0.27	0.15	0.1		
	30" Mounting					0.32	0.29	0.19	0.12		

DECK | STEP | PATIO



**1549 BZ**  
**1549 BZ-LED**  
 ROUND EYEBROW  
 DECK SCONCE  
 3½" DIA., 2¼" EXT.



**1549 MW**  
**1549 MW-LED**  
 ROUND EYEBROW  
 DECK SCONCE  
 3½" DIA., 2¼" EXT.

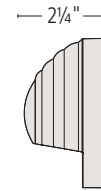

**16801 MZ**  
**16801 MZ-LED**  
 HARDY ISLAND™ ROUND  
 EYEBROW DECK SCONCE  
 3½" DIA., 2¼" EXT.



**16804 MZ**  
**16804 MZ-LED**  
 HARDY ISLAND™ ROUND  
 LOUVERED DECK SCONCE  
 3½" DIA., 2¼" EXT.



LED ITEM	LED ENGINE (INCLUDED)	POWER SUPPLY REQUIREMENT	INCANDESCENT EQUIVALENCY	ITEM	LAMP (INCLUDED)	WATTAGE	FINISH	CONSTRUCTION	GLASS LENS
<b>1549 BZ-LED</b> <b>1549 MW-LED</b>	E5050LED	1.5w / 2.4VA	12w	<b>1549 BZ</b> <b>1549 MW</b>	906	7w	Bronze Matte White	Cast Aluminum	Frosted
<b>16801 MZ-LED</b>	E5050LED	1.5w / 2.4VA	12w	<b>16801 MZ</b>	T3	20w	Matte Bronze	Cast Brass	Frosted
<b>16804 MZ-LED</b>	E5050LED	1.5w / 2.4VA	12w	<b>16804 MZ</b>	T3	20w	Matte Bronze	Cast Brass	Frosted

See pages 80-81 for LED conversion lamps. A wiring kit is supplied. For accessories, see pages 74-75. For transformers, see pages 76-77.

**PHOTOMETRICS (BASED ON VARIOUS MOUNTING HEIGHTS)**

DISTANCE FROM LIGHT		LED ITEM	1'	2'	3'	4'	5'	6'	7'	ITEM	1'	2'	3'	4'	5'	6'	7'	
FOOT CANDLES	6" Mounting	1549 BZ-LED 1549 MW-LED	2.71	1.56	0.43	0.13	0.04			1549 BZ 1549 MW	2.17	1.25	0.34	0.10	0.03			
	18" Mounting		5.41	2.88	1.49	0.21	0.09	0.04			4.33	2.30	1.19	0.17	0.07	0.03		
	30" Mounting		3.40	1.40	0.78	0.38	0.21	0.10	0.05			2.72	1.12	0.62	0.30	0.17	0.08	0.04
	6" Mounting	16801 MZ-LED	2.58	1.48	0.40	0.12	0.04			16801 MZ	1.07	0.64	0.23	0.09	0.03	0.02	0.01	
	18" Mounting		5.14	2.73	1.41	0.20	0.08	0.04			2.03	0.55	0.11	0.05	0.02			
	30" Mounting		3.23	1.33	0.74	0.36	0.20	0.10	0.05			3.56	0.11	0.04				
	6" Mounting	16804 MZ-LED	2.97	1.40	0.47	0.27	0.10			16804 MZ	0.46	0.28	0.14	0.07	0.04	0.03	0.02	
	18" Mounting		1.97	1.64	0.71	0.34	0.21	0.11			0.92	0.33	0.12	0.07	0.04	0.01		
30" Mounting	0.95		0.92	0.63	0.39	0.26	0.16	0.10			2.02	0.17	0.06	0.02				

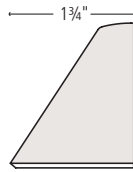

**16805 MZ-LED**  
HARDY ISLAND™ TRIANGULAR  
DECK SCONCE  
3½" W, 2" H, 1¾" EXT.



**1524 BZ**  
**1524 BZ-LED**  
SQUARE DECK SCONCE  
3½" W, 3½" H, 2¼" EXT.

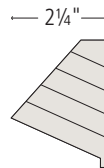

**1524 MW**  
**1524 MW-LED**  
SQUARE DECK SCONCE  
3½" W, 3½" H, 2¼" EXT.



LED ITEM	LED ENGINE (INCLUDED)	POWER SUPPLY REQUIREMENT	INCANDESCENT EQUIVALENCY	ITEM	LAMP (INCLUDED)	WATTAGE	BULB FOR LED CONVERSION (NOT INCLUDED)	FINISH	CONSTRUCTION	GLASS LENS
<b>1524 BZ-LED</b> <b>1524 MW-LED</b>	E5050LED	1.5w / 2.4VA	12w	<b>1524 BZ</b> <b>1524 MW</b>	906	7w	T5 LED	Bronze Matte White	Cast Aluminum	Frosted
<b>16805 MZ-LED</b>	E5050LED	1.5w / 2.4VA	12w					Matte Bronze	Cast Brass	Frosted

See pages 80-81 for LED conversion lamps. A wiring kit is supplied. For accessories, see pages 74-75. For transformers, see pages 76-77.

**PHOTOMETRICS (BASED ON VARIOUS MOUNTING HEIGHTS)**

DISTANCE FROM LIGHT		LED ITEM	1'	2'	3'	4'	5'	6'	7'	ITEM	1'	2'	3'	4'	5'	6'	7'	
FOOT CANDLES	6" Mounting	1524 BZ-LED 1524 MW-LED	4.91	0.75	0.26	0.09	0.01			1524 BZ 1524 MW	3.93	0.60	0.20	0.07	0.01			
	18" Mounting		4.38	1.53	0.55	0.21	0.13	0.08			3.50	1.22	0.44	0.17	0.10	0.06		
	30" Mounting		2.64	1.53	0.75	0.38	0.21	0.10	0.05			2.11	1.22	0.60	0.30	0.17	0.08	0.04
	6" Mounting	16805 MZ-LED	4.40	2.48	0.68	0.10												
	18" Mounting		10.84	5.10	1.64	0.22	0.13	0.04										
	30" Mounting		4.83	3.42	1.93	0.81	0.25	0.12	0.09									



DECK | STEP | PATIO

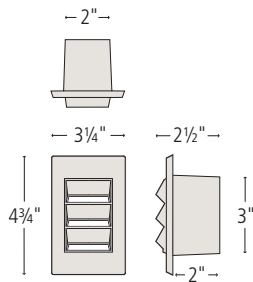

1542 BZ  
1542 BZ-LED  
VERTICAL DECK LIGHT  
3 1/4" W, 4 3/4" H, 2 1/2" D



1542 MZ-LED  
HARDY ISLAND™  
VERTICAL LED DECK LIGHT  
3 1/4" W, 4 3/4" H, 2 1/2" D



LED ITEM	LED ENGINE (INCLUDED)	POWER SUPPLY REQUIREMENT	INCANDESCENT EQUIVALENCY	ITEM	LAMP (INCLUDED)	WATTAGE	BULB FOR LED CONVERSION (NOT INCLUDED)	FINISH	CONSTRUCTION	GLASS LENS
1542 BZ-LED	E5050LED	1.5w / 2.4VA	12w	1542 BZ	912	12w	T5 LED	Bronze	Cast Aluminum	Frosted
1542 MZ-LED	E5050LED	1.5w / 2.4VA	12w					Matte Bronze	Aluminum Housing Cast Brass Faceplate	Frosted

See pages 80-81 for LED conversion lamps. A wiring kit is supplied. For accessories, see pages 74-75. For transformers, see pages 76-77.

PHOTOMETRICS (BASED ON VARIOUS MOUNTING HEIGHTS)

DISTANCE FROM LIGHT		LED ITEM	1'	2'	3'	4'	5'	6'	7'	ITEM	1'	2'	3'	4'	5'	6'	7'	
FOOT CANDLES	6" Mounting	1542 BZ-LED	1.77	0.37	0.12	0.07	0.04			1542 BZ	1.44	0.30	0.10	0.03	0.06			
	18" Mounting		1.02	0.47	0.23	0.11	0.07				0.83	0.38	0.19	0.09	0.06	0.03		
	30" Mounting		0.43	0.34	0.22	0.15	0.09	0.06	0.04		0.35	0.28	0.18	0.12	0.07	0.05	0.03	
	6" Mounting	1542 MZ-LED	2.28	1.08	0.36	0.21	0.07											
	18" Mounting		1.51	1.26	0.55	0.26	0.16	0.09										
	30" Mounting		0.73	0.71	0.48	0.30	0.20	0.12	0.07									



1546 BZ  
1546 BZ-LED  
HORIZONTAL DECK LIGHT  
4¾" W, 3¼" H, 2½" D



1546 CO-LED  
COPPER HORIZONTAL  
LED DECK LIGHT  
4¾" W, 3¼" H, 2½" D



1546 MZ  
1546 MZ-LED  
HARDY ISLAND™  
HORIZONTAL DECK LIGHT  
4¾" W, 3¼" H, 2½" D

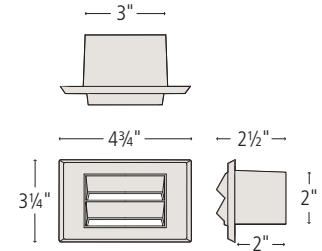

LED ITEM	LED ENGINE (INCLUDED)	POWER SUPPLY REQUIREMENT	INCANDESCENT EQUIVALENCY	ITEM	LAMP (INCLUDED)	WATTAGE	BULB FOR LED CONVERSION (NOT INCLUDED)	FINISH	CONSTRUCTION	GLASS LENS
1546 BZ-LED	E5050LED	1.5w / 2.4VA	12w	1546 BZ	912	12w	T5 LED	Bronze	Cast Aluminum	Frosted
1546 MZ-LED	E5050LED	1.5w / 2.4VA	12w	1546 MZ	912	12w	T5 LED	Matte Bronze	Aluminum Housing Cast Brass Faceplate	Frosted
1546 CO-LED	E5050LED	1.5w / 2.4VA	12w					Copper	Aluminum Housing Solid Copper Faceplate	Frosted

See pages 80-81 for LED conversion lamps. A wiring kit is supplied. For accessories, see pages 74-75. For transformers, see pages 76-77.

**PHOTOMETRICS** (BASED ON VARIOUS MOUNTING HEIGHTS)

DISTANCE FROM LIGHT		LED ITEM	1'	2'	3'	4'	5'	6'	7'	ITEM	1'	2'	3'	4'	5'	6'	7'	
FOOT CANDLES	6" Mounting	1546 BZ-LED	0.30	0.20	0.10	0.04				1546 BZ	0.04	0.06	0.08	0.03				
	18" Mounting		0.77	0.69	0.26	0.10	0.02				0.63	0.56	0.21	0.08	0.02			
	30" Mounting		0.48	0.39	0.27	0.15	0.09	0.04	0.01		0.09	0.32	0.22	0.12	0.07	0.03	0.01	
	6" Mounting	1546 MZ-LED 1546 CO-LED	1.38	0.13	0.05					1546 MZ	1.15	0.11	0.04					
	18" Mounting		0.50	0.28	0.10	0.04	0.01				0.42	0.23	0.08	0.03	0.01			
	30" Mounting		0.22	0.18	0.11	0.06	0.02	0.01			0.14	0.15	0.09	0.05	0.02	0.01		









1594 BZ  
1594 BZ-LED  
LOUVERED BRICK LIGHT  
8¾" W, 3¼" H, 4¼" D

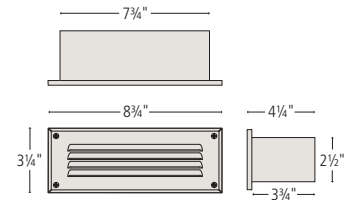

1594 MZ  
1594 MZ-LED  
HARDY ISLAND™  
LOUVERED BRICK LIGHT  
8¾" W, 3¼" H, 4¼" D



LED ITEM	LED ENGINE (INCLUDED)	POWER SUPPLY REQUIREMENT	INCANDESCENT EQUIVALENCY	ITEM	LAMP (INCLUDED)	WATTAGE	BULB FOR LED CONVERSION (NOT INCLUDED)	FINISH	CONSTRUCTION	GLASS LENS
1594 BZ-LED	NX3	3.8w / 5.7VA	25w	1594 BZ	912	12w	T5 LED	Bronze	Galvanized Steel Housing Cast Aluminum Faceplate	Clear
1594 MZ-LED	NX3	3.8w / 5.7VA	25w	1594 MZ	912	12w	T5 LED	Matte Bronze	Galvanized Steel Housing Solid Brass Faceplate	Clear

See pages 80-81 for LED conversion lamps. A wiring kit is supplied. For accessories, see pages 74-75. For transformers, see pages 76-77.

**PHOTOMETRICS** (BASED ON VARIOUS MOUNTING HEIGHTS)

DISTANCE FROM LIGHT		LED ITEM	1'	2'	3'	4'	5'	6'	7'	8'	ITEM	1'	2'	3'	4'	5'	6'	7'	
FOOT CANDLES	6" Mounting	1594 BZ-LED	37.1	11.83	3.06	1.55	1.07	0.85	0.71	0.6	1594 BZ	0.90	0.50	0.23	0.03				
	18" Mounting		0.58	1.19	4.1	2.03	2	1.46	0.87	0.49		0.99	0.73	0.55	0.37	0.17	0.08		
	30" Mounting		0.11	0.27	0.45	0.97	1.55	0.84	0.74	0.74		0.52	0.43	0.36	0.28	0.20	0.16	0.10	
	6" Mounting	1594 MZ-LED	3.07	0.74								1594 MZ	2.19	0.53					
	18" Mounting		1.40	0.32	0.25	0.20							1.00	0.21	0.18	0.14			
	30" Mounting		0.97	0.45	0.42	0.22	0.07						0.69	0.32	0.31	0.05	0.14		

# CARSON

## OUTDOOR CHANDELIERS

GOOD DESIGN NOW EXTENDS BEYOND THE INTERIOR ENVIRONMENT. CONSIDER OUTDOOR CHANDELIERS TO TASTEFULLY ILLUMINATE CHIC CHAISES, DINING SPACES AND COZY ALCOVES, BALANCING CREATURE COMFORTS WITH THE CALL OF THE WILD.

- + WET RATED FOR OUTDOOR USE
- + VINTAGE IRON FINISH
- + CLEAR SEEDY GLASS



29703 VI  
18½" DIA., 18¾" H  
51¾" MAX. H\*



29705 VI  
26½" DIA., 26¼" H  
59¼" MAX. H\*



29700 VI  
10" W, 10½" H



29707 VI  
10" DIA., 10" H  
43" MAX. H\*

ITEM	BULBS	EXT.	TOP TO OUTLET	BACK PLATE/CANOPY	WIRE	STEMS INCLUDED
29700 VI	1-100w Med.	12½"	6"	4¾" Dia. Back Plate		
29703 VI	3-60w Cand.			4¾" Dia. Canopy	10'	1-6", 2-12"
29705 VI	5-60w Cand.			4¾" Dia. Canopy	10'	1-6", 2-12"
29707 VI	1-100w Med.			4¾" Dia. Canopy	10'	1-6", 2-12"

\*Maximum achievable height with stems included. Additional 12" stems available, 6033VI. Ideal for vintage filament bulbs (not included).



# LINE VOLTAGE: 120V

## LIGHTING



51000BZ, PAGE 70



# 120 VOLT

## HINKLEY LIGHTING'S LINE VOLTAGE PRODUCTS OFFER THE LIGHTING PROFESSIONAL A MORE POWERFUL LANDSCAPE LIGHTING OPTION

Line voltage systems operate with more power than their low voltage counterparts and can accommodate larger lamps with much higher wattage, creating significant light output from a small number of fixtures. Line voltage is most commonly used in commercial, security and public use applications. It can also be used in residential applications where extensive up-lighting on large architectural features and mature landscape is required or where a 120v wiring system is already in place.

---

- **LINE VOLTAGE INSTALLATION**

A licensed electrical contractor is required to install Line Voltage landscape lighting systems. When installing 120v systems, the wire must be properly buried at least 18 inches in the ground, placed in a protective conduit and have sealed junction boxes at the connection points. Installation is labor intensive and rigid, which makes line voltage systems a more permanent option than low voltage systems. Installation by a professional will ensure the Line Voltage system functions properly. Local code requirements should be consulted.

- **QUALITY AND DURABILITY**

Hinkley's Line Voltage products are built to last. Constructed of durable aluminum or thermoplastic composite resin, our lighting fixtures stand up to tough weather conditions. Our powder coated finish on all Line Voltage products protects the fixtures from chipping, fading and cracking, which significantly improves the durability and lifespan of our fixtures in even the harshest atmospheric conditions.

- **VALUE AND CONVENIENCE**

Choosing to install a Line Voltage system can be an economical solution in residential situations where a wiring system is already in place. Rather than re-wire a low voltage system, which requires a transformer and a fresh wiring plan, Hinkley Line Voltage fixtures can be put into place with relative ease. A wide variety of lamping options offers convenience when choosing a Line Voltage system. Traditional incandescent lamps can be used and technology advancements have even led to popularity with self-ballasted fluorescent lamps.



**56000 BZ**  
120V MUSHROOM™  
PATH LIGHT  
9½" W, 26" H



**57000 BZ**  
120V 75W MINI-CAN  
FLOOD LIGHT WITH CLEAR LENS  
5½" W, 4" H SHROUD  
5" L, 6¼" H

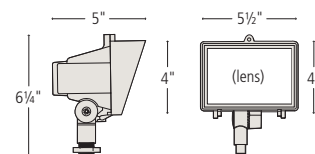

ITEM	56000 BZ	57000 BZ
FINISH	Powder-Coated Bronze (BZ)	Powder-Coated Bronze (BZ)
CONSTRUCTION	Durable Cast Aluminum	Durable Cast Aluminum
LENS	Clear Polycarbonate	Clear Glass: flat, tempered
VOLTAGE	120v	120v
LAMP (Not Included)	A19 (up to 75w)	Mini-Can (up to 75w)
WIRING	6" usable 105°C 18-AWG wire leads	6" usable 200°C 18-AWG wire leads and ground leads
REFLECTOR		Hammertone Finish, High-Performance Aluminum
SHROUD		Cast aluminum housing with silicone o-ring gaskets providing a superior weather-tight seal
SOCKET	Porcelain w/ nickel-plated screw shell	Porcelain mini-can base with spring center contact high temperature leads

For Line Voltage Accessories see page 71.

**PHOTOMETRICS**

DISTANCE FROM LIGHT	ITEM	1'	2'	3'	4'	5'	6'
FOOT CANDLES	56000 BZ	41.67	12.50	4.60	1.39	0.37	0.13

**PHOTOMETRICS (BASED ON VARIOUS MOUNTING DISTANCES AT 22° ANGLE)**

DISTANCE FROM LIGHT		ITEM	1'	2'	3'	4'	5'	6'	7'	8'	9'	10'	11'	12'	13'	14'
FOOT CANDLES	3' From Object	57000 BZ	33.07	23.80	11.98	6.23	2.08	1.12	0.48	0.16	0.06					
	6' From Object		10.69	8.58	7.57	6.47	4.78	3.17	2.49	1.82	0.89	0.55	0.38	0.30	0.21	0.04
	9' From Object		5.00	4.51	4.01	3.55	3.36	2.74	1.90	1.55	1.25	1.02	0.82	0.59	0.36	0.29

120V LANDSCAPE LIGHTING

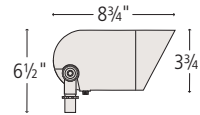

54000 BZ  
54000 BZ-LED30, 54000 BZ-LED60  
3 3/4" DIA. SHROUD, 6 1/2" H  
8 3/4" L SHROUD



55000 BZ  
120V 175W LG. SPOT LIGHT  
(Shown with lens)  
6 1/8" DIA. SHROUD, 8" H  
9 1/4" L WITHOUT SHROUD



55000 BZ  
120V 175W LG. SPOT LIGHT  
(Shown with lens and shroud)  
6 1/8" DIA. SHROUD, 8" H  
17 1/4" L WITH SHROUD

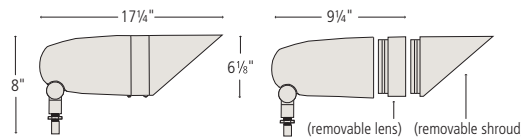





**53000 BZ**  
 BURIAL BALLAST BOX  
 (Ballast Assembly not included)  
 12¼" DIA., 14½" H  
 8" DIA. BASE



ITEM	53000 BZ	54000 BZ	54000 BZ-LED30	54000 BZ-LED60	55000 BZ
NAME	Burial Ballast Box (made for use with 54000 BZ and 55000 BZ)	75w Sm. Spot Light	120v 7w 30° LED Spot Light	120v 7w 60° LED Spot Light	175w Lg. Spot Light (Removable Lens and Shroud)
FINISH	Bronze (BZ)	Powder-Coated Bronze (BZ)	Powder-Coated Bronze (BZ)	Powder-Coated Bronze (BZ)	Powder-Coated Bronze (BZ)
CONSTRUCTION	Thermoplastic composite resin with molded ribbing to prevent ground shifting. Composite cover has ½"-14NPS hub for direct mount.	Durable Cast Aluminum	Durable Cast Aluminum	Durable Cast Aluminum	Durable Cast Aluminum
LENS		Clear, Convex, Tempered	Clear, Convex, Tempered	Clear, Convex, Tempered	Clear, Convex, Tempered
VOLTAGE		120v	120v	120v	120v
LAMP/LED ENGINE	For use with 54000 BZ and 55000 BZ	PAR16 or PAR20 Not Included	E0055LED Included	E0055LED Included	PAR38 Not Included
WATTAGE		up to 75w	7w	7w	up to 175w
WIRING/ WIRING COMPARTMENT	Isolated sealable wiring compartment. Cover has (2) threaded ¼"-14NPS entries for conduit re-attachment. Encapsulant potting compound included.	6" usable 200°C 18-AWG wire leads and ground leads	6" usable 200°C 18-AWG wire leads and ground leads	6" usable 200°C 18-AWG wire leads and ground leads	6" usable 200°C 18-AWG wire leads and ground leads
GASKET	EPDM, 1-piece molded silicone gasket				
SHROUD		Durable cast aluminum housing with silicone o-rings providing a superior weather-tight seal	Durable cast aluminum housing with silicone o-rings providing a superior weather-tight seal	Durable cast aluminum housing with silicone o-rings providing a superior weather-tight seal	Durable cast aluminum housing with silicone o-rings providing a superior weather-tight seal
SOCKET		Porcelain Medium Base	Porcelain Medium Base	Porcelain Medium Base	Porcelain Medium Base

For Line Voltage Accessories, see page 71.



# LUNA STEP LIGHT

THE PERFECT SOLUTION FOR ANY  
INDOOR OR OUTDOOR 120V OUTLET  
OR SWITCH LOCATION

- + FULLY DIMMABLE
- + FITS SINGLE OR DOUBLE STANDARD GANG JUNCTION BOX
- + 4W POWER CONSUMPTION
- + DIE CAST ZINC ALUMINUM ALLOY
- + INDOOR/OUTDOOR ETL RATED





**58504 BZ**  
120V LUNA™ STEP LIGHT  
3" W, 4½" H  
 



**58504 SW**  
120V LUNA™ STEP LIGHT  
3" W, 4½" H  
 





**58504 LA**  
120V LUNA™ STEP LIGHT  
3" W, 4½" H  
 



**58504 TT**  
120V LUNA™ STEP LIGHT  
3" W, 4½" H  
 



**58504 MZ**  
120V LUNA™ STEP LIGHT  
3" W, 4½" H  
 

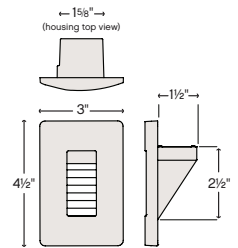

 LED ITEM	LED ENGINE (INCLUDED)	WATTAGE	INCANDESCENT EQUIVALENCY	FINISH	CONSTRUCTION
<b>58504 BZ</b>	LS-20	4w	20w	Bronze	Zinc Aluminum Alloy
<b>58504 LA</b>	LS-20	4w	20w	Light Almond	Zinc Aluminum Alloy
<b>58504 MZ</b>	LS-20	4w	20w	Matte Bronze	Forged Brass Face Plate
<b>58504 SW</b>	LS-20	4w	20w	Satin White	Zinc Aluminum Alloy
<b>58504 TT</b>	LS-20	4w	20w	Titanium	Zinc Aluminum Alloy

For Line Voltage Accessories, see page 71.

**PHOTOMETRICS (BASED ON VARIOUS MOUNTING HEIGHTS)**

DISTANCE FROM LIGHT		LED ITEM	1'	2'	3'	4'	5'	6'	7'	8'
FOOT CANDLES	8" Mounting	58504 BZ	6.36	1.01	0.22					
	16" Mounting		2.6	1.65	0.67	0.3	0.13			
	30" Mounting		0.16	1.1	0.69	0.4	0.23	0.13		
	8" Mounting	58504 LA	8.79	2.0	0.79	0.38	0.21	0.13	0.09	
	16" Mounting		3.03	2.12	0.89	0.43	0.23	0.14	0.06	
	30" Mounting			1.14	0.81	0.45	0.28	0.16	0.11	0.08
	8" Mounting	58504 MZ	6.74	1.12	0.24					
	16" Mounting		2.73	1.82	0.73	0.31	0.14			
	30" Mounting			1.22	0.76	0.40	0.23	0.12		
	8" Mounting	58504 SW	9.29	2.6	1.17	0.64	0.42	0.29	0.21	0.16
	16" Mounting		3.0	2.32	1.17	0.66	0.41	0.28	0.2	0.15
	30" Mounting		0.25	1.19	0.93	0.6	0.4	0.29	0.21	0.16
	8" Mounting	58504 TT	9.05	2.2	0.83	0.4	0.25	0.16	0.11	
	16" Mounting		3.16	2.17	0.97	0.49	0.27	0.16	0.1	
	30" Mounting		0.1	1.29	0.86	0.52	0.33	0.22	0.15	0.1



120V LANDSCAPE LIGHTING



**58508 BZ**  
120V LUNA™ STEP LIGHT  
4½" W, 3" H



**58508 LA**  
120V LUNA™ STEP LIGHT  
4½" W, 3" H



**58508 MZ**  
120V LUNA™ STEP LIGHT  
4½" W, 3" H



**58508 SW**  
120V LUNA™ STEP LIGHT  
4½" W, 3" H



**58508 TT**  
120V LUNA™ STEP LIGHT  
4½" W, 3" H

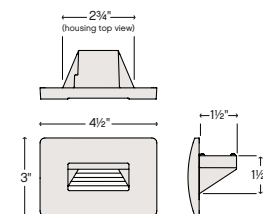

LED ITEM	LED ENGINE (INCLUDED)	POWER SUPPLY REQUIREMENT	INCANDESCENT EQUIVALENCY	FINISH	CONSTRUCTION
58508 BZ	LS-20	4w	20w	Bronze	Zinc Aluminum Alloy
58508 LA	LS-20	4w	20w	Light Almond	Zinc Aluminum Alloy
58508 MZ	LS-20	4w	20w	Matte Bronze	Forged Brass Face Plate
58508 SW	LS-20	4w	20w	Satin White	Zinc Aluminum Alloy
58508 TT	LS-20	4w	20w	Titanium	Zinc Aluminum Alloy

For Line Voltage Accessories, see page 71.

PHOTOMETRICS (BASED ON VARIOUS MOUNTING HEIGHTS)

DISTANCE FROM LIGHT		LED ITEM	1'	2'	3'	4'	5'	6'	7'	8'	
FOOT CANDLES	8" Mounting	58508 BZ	3.58	0.71	0.2						
	16" Mounting			0.86	0.38	0.15					
	30" Mounting				0.27	0.24	0.13				
	8" Mounting	58508 LA	4.41	1.64	0.32	0.24	0.13	0.09			
	16" Mounting			0.97	0.50	0.26	0.14	0.10			
	30" Mounting				0.29	0.27	0.18	0.12			
	8" Mounting	58508 MZ	3.79	0.79	0.23						
	16" Mounting			0.90	0.41	0.17					
	30" Mounting				0.33	0.29	0.14				
	8" Mounting	58508 SW	7.0	2.19	0.97	0.57	0.37	0.26	0.19	0.14	
	16" Mounting			0.66	0.158	0.85	0.5	0.32	0.23	0.16	0.12
	30" Mounting				0.32	0.52	0.43	0.3	0.23	0.16	0.12
	8" Mounting	58508 TT	4.5	1.8	0.45	0.25	0.15	0.11			
	16" Mounting				1.03	0.54	0.27	0.15	0.1		
	30" Mounting					0.32	0.29	0.19	0.12		



**58506 BZ**  
120V LUNA™ STEP LIGHT  
4¾" W, 4½" H



**58506 LA**  
120V LUNA™ STEP LIGHT  
4¾" W, 4½" H



**DOUBLE GANG** configuration



**58506 SW**  
120V LUNA™ STEP LIGHT  
4¾" W, 4½" H

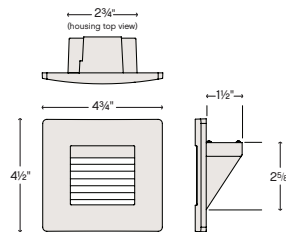

**58506 TT**  
120V LUNA™ STEP LIGHT  
4¾" W, 4½" H



LED ITEM	LED ENGINE	WATTAGE	INCANDESCENT EQUIVALENCY	FINISH	CONSTRUCTION
<b>58506 BZ</b>	LS-20	4w	20w	Bronze	Zinc Aluminum Alloy
<b>58506 LA</b>	LS-20	4w	20w	Light Almond	Zinc Aluminum Alloy
<b>58506 SW</b>	LS-20	4w	20w	Satin White	Zinc Aluminum Alloy
<b>58506 TT</b>	LS-20	4w	20w	Titanium	Zinc Aluminum Alloy

For Line Voltage Accessories, see page 71.

**PHOTOMETRICS** (BASED ON VARIOUS MOUNTING HEIGHTS)

DISTANCE FROM LIGHT		LED ITEM	1'	2'	3'	4'	5'
FOOT CANDLES	8" Mounting	58506 BZ	4.76	0.47	0.08		
	16" Mounting		2.24	0.92	0.17	0.06	
	30" Mounting		1.08	0.65	0.21	0.11	0.03
	8" Mounting	58506 LA	6.33	0.84	0.21	0.08	
	16" Mounting		4.11	1.22	0.34	0.13	0.09
	30" Mounting		2.47	0.83	0.46	0.15	0.06
	8" Mounting	58506 SW	7.15	0.89	0.20	0.08	
	16" Mounting		3.22	0.77	0.31	0.14	0.07
	30" Mounting		2.12	0.81	0.26	0.15	0.06
	8" Mounting	58506 TT	6.86	0.70	0.16	0.06	
	16" Mounting		2.97	1.13	0.39	0.11	0.05
	30" Mounting		1.88	0.95	0.23	0.14	0.06

120V LANDSCAPE LIGHTING

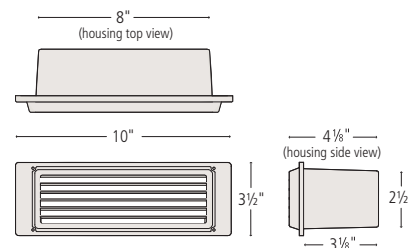

**59009 BZ**  
120V 9W CFL  
BRICK LIGHT  
10" W, 3 1/2" H, 4 1/8" D



**59024 BZ-LED**  
120V LED  
BRICK LIGHT  
10" W, 3 1/2" H, 4 1/8" D



**59040 BZ**  
120V 40W G9  
BRICK LIGHT  
10" W, 3 1/2" H, 4 1/8" D



ITEM	59009 BZ	59024 BZ-LED	59040 BZ
NAME	Brick Light (9w) CFL	120v LED Brick Light	Brick Light (40w) G9
FINISH	Powder-Coated Bronze (BZ)	Powder-Coated Bronze (BZ)	Powder-Coated Bronze (BZ)
CONSTRUCTION	Cast aluminum with a silicone gasket providing a superior weather-tight seal	Cast aluminum with a silicone gasket providing a superior weather-tight seal	Cast aluminum with a silicone gasket providing a superior weather-tight seal
LENS	Frosted, Flat	Clear, Flat	Frosted, Flat
VOLTAGE	120v	120v	120v
LAMP/LED ENGINE	9w CFL GX23-2 Not Included	3.8w NX3 Included	40w G9 Not Included
WIRING/ WIRING COMPARTMENT	6" usable 200°C 18-AWG wire leads and ground leads	6" usable 200°C 18-AWG wire leads and ground leads	6" usable 200°C 18-AWG wire leads and ground leads
SOCKET	Plastic GX23-2		White Porcelain Bi-Pin Base

For Line Voltage Accessories, see page 71.

**PHOTOMETRICS (BASED ON VARIOUS MOUNTING HEIGHTS)**

DISTANCE FROM LIGHT		ITEM/LED ITEM	1'	2'	3'	4'	5'	6'	7'	8'	9'
FOOT CANDLES	6" Mounting	59009 BZ	6.25	2.44	0.97	0.27	0.12	0.04			
	12" Mounting		1.58	1.55	1.51	0.89	0.37	0.19	0.11	0.08	0.06
	18" Mounting		0.70	0.66	0.63	0.59	0.53	0.42	0.26	0.15	0.03
	6" Mounting	59024 BZ-LED	7.65	2.66	1.19	0.51	0.06				
	12" Mounting		3.19	2.71	2.61	1.34	0.40	0.24	0.19	0.14	0.08
	18" Mounting		0.86	0.82	0.68	0.53	0.50	0.44	0.32	0.20	0.11
	6" Mounting	59040 BZ	10.20	3.55	1.58	0.68	0.08				
	12" Mounting		4.25	3.61	3.48	1.79	0.53	0.32	0.25	0.18	0.11
	18" Mounting		1.15	1.06	0.89	0.68	0.64	0.58	0.41	0.25	0.15



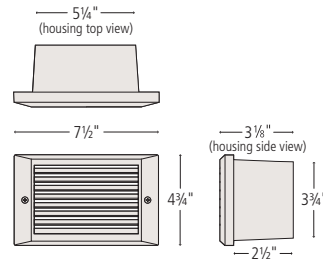

**58009 BZ**  
120V 9W CFL  
STEP LIGHT  
7 1/2" W, 4 3/4" H, 3 1/8" D



**58015 BZ-LED**  
120V LED  
STEP LIGHT  
7 1/2" W, 4 3/4" H, 3 1/8" D



**58025 BZ**  
120V 25W G9  
STEP LIGHT  
7 1/2" W, 4 3/4" H, 3 1/8" D



ITEM	58009 BZ	58015 BZ-LED	58025 BZ
NAME	Step Light (9w) CFL	120v LED Step Light	Step Light (25w) G9
FINISH	Powder-Coated Bronze (BZ)	Powder-Coated Bronze (BZ)	Powder-Coated Bronze (BZ)
CONSTRUCTION	Cast aluminum with a silicone gasket providing a superior weather-tight seal	Cast aluminum with a silicone gasket providing a superior weather-tight seal	Cast aluminum with a silicone gasket providing a superior weather-tight seal
LENS	Frosted, Flat	Frosted, Flat	Frosted, Flat
VOLTAGE	120v	120v	120v
LAMP/LED ENGINE	9w CFL GX23-2 Not Included	3.8w NX3 Included	25w G9 Not Included
WIRING/ WIRING COMPARTMENT	6" usable 200°C 18-AWG wire leads and ground leads	6" usable 200°C 18-AWG wire leads and ground leads	6" usable 200°C 18-AWG wire leads and ground leads
SOCKET	Plastic GX23-2		White Porcelain Bi-Pin Base

For Line Voltage Accessories, see page 71.

**PHOTOMETRICS (BASED ON VARIOUS MOUNTING HEIGHTS)**

DISTANCE FROM LIGHT		ITEM/LED ITEM	1'	2'	3'	4'	5'	6'	7'	8'
FOOT CANDLES	6" Mounting	58009 BZ	9.68	2.01	0.58	0.19	0.06			
	18" Mounting		1.67	1.41	1.07	0.63	0.33	0.18	0.10	
	6" Mounting	58015BZ-LED	15.55	3.65	0.94	0.31	0.10	0.03		
	18" Mounting		3.09	2.25	1.73	1.10	0.49	0.29		
	6" Mounting	58025 BZ	16.37	3.84	0.99	0.33	0.11	0.03	0.20	0.10
	18" Mounting		3.25	2.37	1.82	1.16	0.52	0.30	0.21	0.10

120V LANDSCAPE LIGHTING

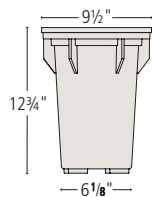

**51000 BZ**  
120V 100W SM.  
IN-GROUND WELL LIGHT  
9 1/2" DIA., 12 3/4" H  
6 1/8" DIA. BASE



**51070 BZ**  
120V 70W SM.  
IN-GROUND WELL LIGHT  
9 1/2" DIA., 12 3/4" H  
6 1/8" DIA. BASE



**52000 BZ**  
120V 100W LG.  
IN-GROUND WELL LIGHT  
12 1/4" DIA., 14 1/2" H  
8" DIA. BASE



ITEM	51000 BZ	51070 BZ	52000 BZ
FINISH	Bronze (BZ)	Bronze (BZ)	Bronze (BZ)
CONSTRUCTION	Thermoplastic composite resin with molded ribbing to prevent ground shifting.	Thermoplastic composite resin with molded ribbing to prevent ground shifting.	Thermoplastic composite resin with molded ribbing to prevent ground shifting.
LENS	Clear, Flat	Clear, Flat	Clear, Flat
VOLTAGE	120v	120v	120v
LAMP Not Included	100w Max. Incandescent	70w Max. Incandescent	100w Max. Incandescent
WIRING/ WIRING COMPARTMENT	6" usable 105°C 18-AWG wire leads and ground leads. Isolated sealable wiring compartment. Cover has (2) threaded 3/4"-14NPS entries for conduit re-attachment. Encapsulant potting compound included.	6" usable 105°C 18-AWG wire leads and ground leads. Isolated sealable wiring compartment. Cover has (2) threaded 3/4"-14NPS entries for conduit attachment. Encapsulant potting compound included.	6" usable 105°C 18-AWG wire leads and ground leads. Isolated sealable wiring compartment. Cover has (2) threaded 3/4"-14NPS entries for conduit attachment. Encapsulant potting compound included.
GASKET	EPDM 1-piece Molded Silicone U-Channel	EPDM 1-piece Molded Silicone U-Channel	EPDM 1-piece Molded Silicone U-Channel
REFLECTOR	120° Hydroformed Alzak-Finished Aluminum	120° Hydroformed Alzak-Finished Aluminum	84° Hydroformed Alzak-Finished Hammered Aluminum
SOCKET	Porcelain Medium Base	Porcelain Medium Base	Porcelain Medium Base
LIVE LOAD CAPACITY	2200 lbs.	2200 lbs.	2600 lbs.
ACCESSORIES	Small Concrete Kit: 51010 CK Small Rock Guard: 51901 BZ	Small Concrete Kit: 51010 CK Small Rock Guard: 51901 BZ	Large Concrete Kit: 52010 CK Large Rock Guard: 52901 BZ

For Line Voltage Accessories, see page 71.



50500 PP  
POWER POST



51901 BZ, 52901 BZ  
SMALL AND LARGE  
ROCK GUARD



50400 HG  
WELL LIGHT  
HIGH GEL



50200 WN  
WIRE CONNECTORS



51010 CK, 52010 CK  
CONCRETE KIT



50300 SF  
SCOTCH-FIL

ITEM	NAME	DESCRIPTION	WIDTH/DIAMETER	HEIGHT	LENGTH	DETAILS
50200 WN	Silicone Wire Connectors	Outdoor Wire Connectors	5/8" Dia.		1 1/4"	Package of 20
50300 SF	Scotch-Fil	Conduit Sealant			2"	Sold in (4) 2" Strips
50400 HG	Well Light High Gel	Encapsulant Potting Compound				82g Pack
50500 PP	Power Post	Landscape Splice Post with Junction Box	3/4" Dia. 7" W (with fins)	20 1/2"		PVC
51010 CK	Concrete Kit (Small)	Pour Kit for Small Well Lights	10 3/4" Dia.	6"		PVC
51901 BZ	Small Rock Guard	For use with 51000 BZ, 51070 BZ	9 1/2" Dia.	1 1/4"		Composite
52010 CK	Concrete Kit (Large)	Pour Kit for Large Well Lights	14" Dia.	6"		PVC
52901 BZ	Large Rock Guard	For use with 52000 BZ, 52175 BZ	12 1/4" Dia.	1 1/4"		Composite



# HINKLEY'S GUIDE TO ILLUMINATING THE OUTDOORS

Dig in to Hinkley's *Landscape Lighting Made Simple™* magazine! Enjoy learning about the best products and planning tools to get a head start on expanding your environment. Helpful how-tos and easy-to-understand LED technology tips will make learning about landscape lighting a breeze!

## ARTICLES INCLUDE:

- + The techniques and terminology common to landscape lighting
- + Selecting the right type of fixtures and developing a plan for your property
- + Understanding power requirements and energy-efficient features
- + Unifying the relationship between your home and its natural surroundings to create a seamless and enjoyable outdoor living space

FOR MORE INFORMATION, VISIT THE  
IDEA CENTER ON [HINKLEYLIGHTING.COM](http://HINKLEYLIGHTING.COM)



## CHECK OUT OTHER EDUCATIONAL TOOLS IN HINKLEY'S LIGHTING MADE SIMPLE SUITE OF MATERIALS:



VIDEO WORKSHOPS available at  
[youtube.com/hinkleylightinginc](http://youtube.com/hinkleylightinginc)



The original *Lighting Made Simple™* publication



LIGHTING 101 INTERACTIVE SHOW HOUSES  
on [hinkleylighting.com](http://hinkleylighting.com)



# ACCESSORIES

12 VOLT



SHELTER I547KZ, PAGE 34

ACCESSORIES



ITEM	NAME	FINISH	CONSTRUCTION
0005 BK, 0005 SC	Coupler	Black, Southern Clay	Aluminum
0006-T BK, 0006-T SC	6" Path Light Stem	Black, Southern Clay	Aluminum
0012-T BK, 0012-T SC	12" Path Light Stem	Black, Southern Clay	Aluminum
0015 BZ	Surface Mount	Bronze	Cast Aluminum
0018-T BK, 0018-T SC	18" Path Light Stem	Black, Southern Clay	Aluminum
0021 BZ	Tree Mount	Bronze	Cast Aluminum
0022 BZ	Junction Box Cover	Bronze	Aluminum
0024-T BK, 0024-T SC	24" Path Light Stem	Black, Southern Clay	Aluminum
0030 BZ	Junction Box Cover	Bronze	Aluminum
0100 FT	100' Wire (12 AWG)	Black	Stranded 2-Wire
0250 FT	250' Wire (12 AWG)	Black	Stranded 2-Wire
0251 FT	250' Wire (10 AWG)	Black	Stranded 2-Wire
0500 FT	500' Wire (12 AWG)	Black	Stranded 2-Wire
0516 FT	500' Wire (16 AWG)	Black	Stranded 2-Wire
1507 QC	Quick Connect	Black	Composite
16807 MZ	Cast Brass Surface Mount	Matte Bronze	Cast Brass
16902 MZ	24" Double Mount T-Stem	Matte Bronze	Cast Brass
16910 MZ	10" Stem Mount	Matte Bronze	Cast Brass
16918 MZ	18" Stem Mount	Matte Bronze	Cast Brass
16990 MZ	24" 90° Mount Stem	Matte Bronze	Cast Brass
50200 WN	Wire Connectors (20 pack)		Silicone



PERFORMANCE LENSES



**0016 CB**  
CORRECTIVE BLUE LENS  
2" DIA., 1/8" D  
Enhances color;  
creates moonlight effect

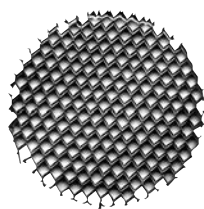

**0016 HL**  
HEX LOUVER LENS  
2" DIA., 1/8" D  
**0037 HL**  
3" DIA., 1/8" D  
Reduces overall glare



**0016 LF**  
LINEAR FILTER LENS  
2" DIA., 1/8" D  
Creates directional beam  
(vertical/horizontal)

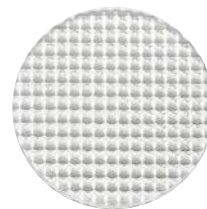

**0016 PF**  
PRISMATIC FILTER LENS  
2" DIA., 1/8" D  
Diffuses lamp  
beam spread

**0016 LENSES**  
are used with the following  
spotlights: 1536 series,  
1538 BZ, 1583 NC

**0037 HEX LOUVER LENS**  
is used with 54000 BZ

Lenses come in packages of 6.



**16814 BZ**  
HEAVY DUTY  
GROUND SPIKE  
2 3/4" DIA., 16" H



**16814 MZ**  
HEAVY DUTY  
GROUND SPIKE  
2 3/4" DIA., 16" H



**0019 BZ**  
GROUND SPIKE  
2" W, 15" H



**0013-JBBZ**  
GROUND SPIKE  
2" W, 9" H



**0017-JBBZ**  
GROUND SPIKE  
4 1/2" W, 11" H



**0014 BZ**  
GROUND SPIKE  
2 3/4" W, 9" H

ITEM	NAME	FINISH	CONSTRUCTION
<b>0013-JBBZ</b>	Ground Spike with Junction Box	Bronze	Cast Aluminum
<b>0014 BZ</b>	Ground Spike	Bronze	Composite
<b>0016 CB</b>	Corrective Blue Lens (6 pack)		Glass
<b>0016 HL</b>	Hex Louver Lens (6 pack)		Aluminum
<b>0016 LF</b>	Linear Filter Lens (6 pack)		Glass
<b>0016 PF</b>	Prismatic Filter Lens (6 pack)		Glass
<b>0017-JBBZ</b>	Ground Spike with Junction Box	Bronze	Composite
<b>0019 BZ</b>	Ground Spike	Bronze	Composite
<b>0037 HL</b>	Hex Louver Lens (6 pack)		Aluminum
<b>16814 BZ</b>	Heavy Duty Ground Spike	Bronze	Aluminum/Composite
<b>16814 MZ</b>	Heavy Duty Ground Spike	Matte Bronze	Brass/Composite

TRANSFORMERS

STANDARD TRANSFORMER



0150 BK  
150W STANDARD TRANSFORMER

For additional information on how to select the proper transformer, view the **DESIGN + INSTALLATION GUIDES** on pages 84-88.

PRO-SERIES TRANSFORMERS



0075W SS  
75W PRO-SERIES™  
TRANSFORMER



0150 SS  
150W PRO-SERIES™  
TRANSFORMER



0300 SS  
300W PRO-SERIES™  
TRANSFORMER



0600 SS  
600W PRO-SERIES™  
TRANSFORMER



0900 SS  
900W PRO-SERIES™  
TRANSFORMER

TRANSFORMER ACCESSORIES



1505 TC  
STANDARD  
TIME CLOCK



1580 DT  
DIGITAL ASTRONOMICAL  
TIME CLOCK









1503 PH  
DIRECT MOUNT  
PHOTOCELL



1510 PH  
PHOTOCELL WITH  
10' LEAD WIRE

ITEM	NAME	CONSTRUCTION	FINISH	WIDTH	HEIGHT	DEPTH	WATTAGE (VA)	TAP
0075W SS	75w Pro-Series Transformer	Stainless Steel		6½"	13¼"	5½"	75w	12v+15v only
0150 BK	150w Standard Transformer	Composite Resin	Black	4¼"	6¼"	3¾"	150w	12v
0150 SS	150w Pro-Series Transformer	Stainless Steel		6½"	13¼"	5½"	150w	12v+15v only
0300 SS	300w Pro-Series Transformer	Stainless Steel		6½"	18"	6"	300w	12v-15v
0600 SS	600w Pro-Series Transformer	Stainless Steel		6½"	18"	6"	600w	12v-15v
0900 SS	900w Pro-Series Transformer	Stainless Steel		8½"	18"	7"	900w	12v-15v
1503 PH	Direct Mount Photocell		Black					
1505 TC	Standard Time Clock		Black	2¾"	3⅞"	2¼"		
1510 PH	Photocell with 10' Lead Wire		Black					
1580 DT	Digital Astronomical Time Clock		White	3⅞"	3¼"	2⅞"		

TRANSFORMER FEATURE GUIDE	STANDARD TRANSFORMER	PRO-SERIES TRANSFORMERS				
						
STYLE	COMPOSITE RESIN	STAINLESS STEEL	STAINLESS STEEL	STAINLESS STEEL	STAINLESS STEEL	STAINLESS STEEL
MODEL	<b>0150 BK</b>	<b>0075W SS</b>	<b>0150 SS</b>	<b>0300 SS</b>	<b>0600 SS</b>	<b>0900 SS</b>
WATTAGE	150	75	150	300	600	900
BLACK COMPOSITE RESIN	✓					
STAINLESS STEEL		✓	✓	✓	✓	✓
12V-15V MULTI-TAP	12v only	12v + 15v only	12v + 15v only	✓	✓	✓
AUTOMATIC TIMER (4H, 6H, 8H)	✓					
MODULAR TIMER AVAILABLE		✓	✓	✓	✓	✓
PHOTOCELL	✓					
MODULAR PHOTOCELL AVAILABLE		✓	✓	✓	✓	✓
AUTO ON/OFF SWITCH	✓					
3' LINE CORD	✓	✓	✓	✓	✓	✓
BOTTOM PLATE		✓	✓	✓	✓	✓
THERMAL CUT-OFF PRIMARY SIDE	✓	✓	✓	✓	✓	✓
THERMAL RESET SECONDARY	✓					
MAGNETIC RESET SECONDARY		✓	✓	✓	✓	✓
STANDARD TERMINAL BLOCK	✓					
HIGH CAPACITY TERMINAL BLOCK		✓	✓	✓	✓	✓
10-YEAR WARRANTY	✓					
LIFETIME WARRANTY		✓	✓	✓	✓	✓



# 1536 PHOTOMETRICS

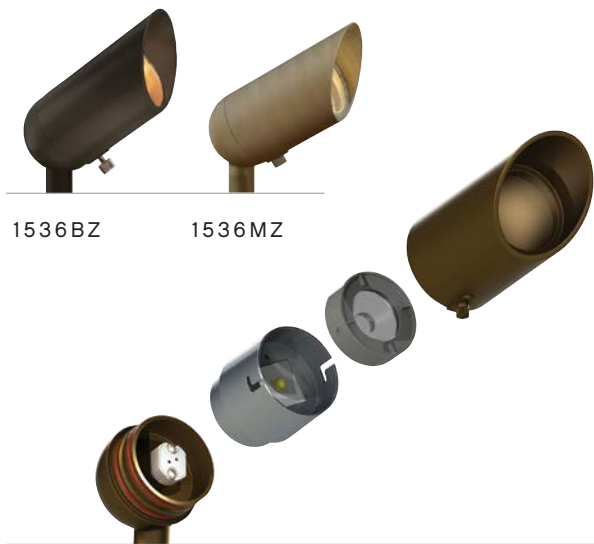

1536BZ

1536MZ

BI-PIN SOCKET + LED ENGINE + CHANGEABLE LENS

The **1536 SERIES** is a cutting edge modular LED light engine system designed to meet any spot light need.

SEE PAGE 16.

## PHOTOMETRIC GUIDE

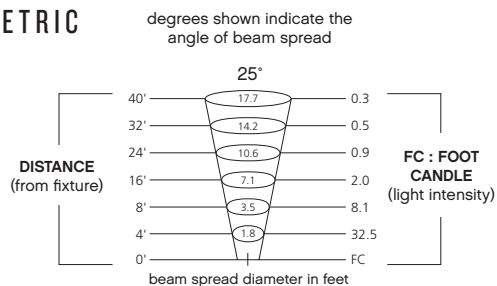

## FIELD CHANGEABLE LENS OPTIONS

25° SPOT LIGHT 2700K	3W   1536XX-3W27SP		5W   1536XX-5W27SP		7.5W   1536XX-8W27SP	
	LUMENS	CANDLE POWER	LUMENS	CANDLE POWER	LUMENS	CANDLE POWER
	224	1447	333	2157	438	2830
25° SPOT LIGHT 3000K	3W   1536XX-3WLEDSP		5W   1536XX-5WLEDSP		7.5W   1536XX-8WLEDSP	
	LUMENS	CANDLE POWER	LUMENS	CANDLE POWER	LUMENS	CANDLE POWER
	239	1546	356	2304	468	3023

40° MEDIUM LIGHT 2700K	3W   1536XX-3W27MD		5W   1536XX-5W27MD		7.5W   1536XX-8W27MD	
	LUMENS	CANDLE POWER	LUMENS	CANDLE POWER	LUMENS	CANDLE POWER
	233	784	354	1194	461	1552

	<p>40°</p>  <p>40' 30.7 0.5 32' 24.6 0.8 24' 18.4 1.4 16' 12.3 3.1 8' 6.1 12.3 4' 3.1 49.0 0' beam spread diameter in feet</p>	<p>40°</p>  <p>40' 30.7 0.7 32' 24.6 1.2 24' 18.4 2.1 16' 12.3 4.7 8' 6.1 18.7 4' 3.1 74.6 0' beam spread diameter in feet</p>	<p>40°</p>  <p>40' 30.7 1.0 32' 24.6 1.5 24' 18.4 2.7 16' 12.3 6.1 8' 6.1 24.3 4' 3.1 97.0 0' beam spread diameter in feet</p>
---	---	--	---

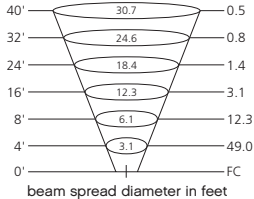
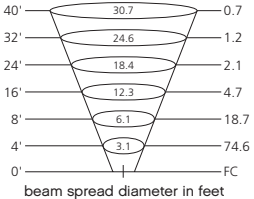
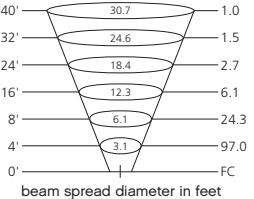
40° MEDIUM LIGHT 3000K	3W   1536XX-3WLEDMD		5W   1536XX-5WLEDMD		7.5W   1536XX-8WLEDMD	
	LUMENS	CANDLE POWER	LUMENS	CANDLE POWER	LUMENS	CANDLE POWER
	249	838	378	1276	493	1658

	<p>40°</p>  <p>40' 30.7 0.5 32' 24.6 0.8 24' 18.4 1.5 16' 12.3 3.3 8' 6.1 13.1 4' 3.1 52.4 0' beam spread diameter in feet</p>	<p>40°</p>  <p>40' 30.7 0.8 32' 24.6 1.2 24' 18.4 2.2 16' 12.3 5.0 8' 6.1 19.9 4' 3.1 79.8 0' beam spread diameter in feet</p>	<p>40°</p>  <p>40' 30.7 1.0 32' 24.6 1.6 24' 18.4 2.9 16' 12.3 6.5 8' 6.1 25.9 4' 3.1 103.6 0' beam spread diameter in feet</p>
---	---	--	--

60° FLOOD LIGHT 2700K	3W   1536XX-3W27FL		5W   1536XX-5W27FL		7.5W   1536XX-8W27FL	
	LUMENS	CANDLE POWER	LUMENS	CANDLE POWER	LUMENS	CANDLE POWER
	237	506	360	765	470	998

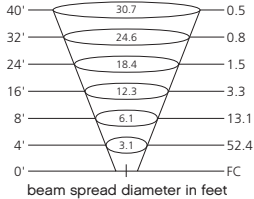
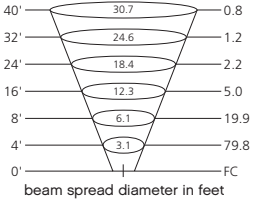
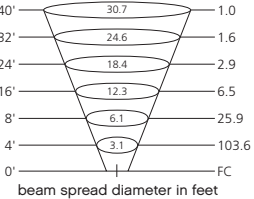
	<p>60°</p>  <p>40' 46.2 0.3 32' 36.9 0.5 24' 27.7 0.9 16' 18.5 2.0 8' 9.2 7.9 4' 4.6 31.6 0' beam spread diameter in feet</p>	<p>60°</p>  <p>40' 46.2 0.5 32' 36.9 0.7 24' 27.7 1.3 16' 18.5 3.0 8' 9.2 12.0 4' 4.6 47.8 0' beam spread diameter in feet</p>	<p>60°</p>  <p>40' 46.2 0.6 32' 36.9 1.0 24' 27.7 1.7 16' 18.5 3.9 8' 9.2 15.6 4' 4.6 62.4 0' beam spread diameter in feet</p>
---	--	--	---

60° FLOOD LIGHT 3000K	3W   1536XX-3WLEDFL		5W   1536XX-5WLEDFL		7.5W   1536XX-8WLEDFL	
	LUMENS	CANDLE POWER	LUMENS	CANDLE POWER	LUMENS	CANDLE POWER
	255	541	385	817	502	1066

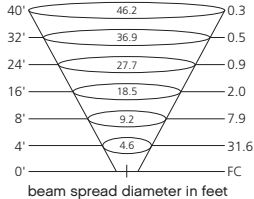
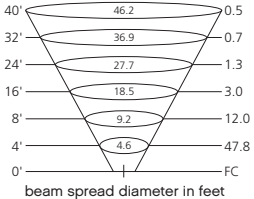
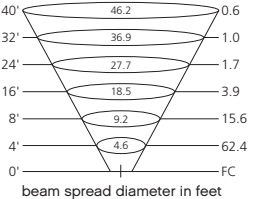

	<p>60°</p>  <p>40' 46.2 0.3 32' 36.9 0.5 24' 27.7 0.9 16' 18.5 2.1 8' 9.2 8.5 4' 4.6 33.8 0' beam spread diameter in feet</p>	<p>60°</p>  <p>40' 46.2 0.5 32' 36.9 0.8 24' 27.7 1.4 16' 18.5 3.2 8' 9.2 12.8 4' 4.6 51.1 0' beam spread diameter in feet</p>	<p>60°</p>  <p>40' 46.2 0.7 32' 36.9 1.0 24' 27.7 1.9 16' 18.5 4.2 8' 9.2 16.7 4' 4.6 66.6 0' beam spread diameter in feet</p>
---	--	--	---

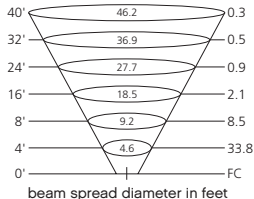
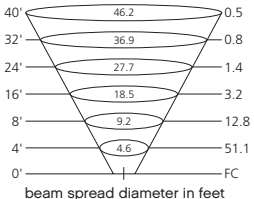
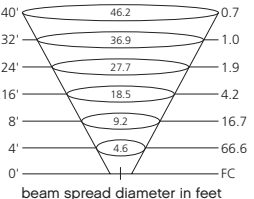
# LED BULBS

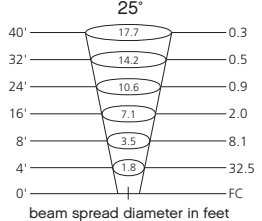
2W27K25		MR16 LED	PHOTOMETRICS
	WATTAGE	2w	 <p>25°</p> <p>beam spread diameter in feet</p>
	BEAM SPREAD	25°	
	COLOR TEMP.	2700K	
	LUMENS	160	
	CANDLE POWER	520	
	BASE	Bi-Pin	
	LIFESPAN	50,000 Hrs.	

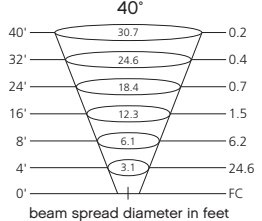
2W27K40		MR16 LED	PHOTOMETRICS
	WATTAGE	2w	 <p>40°</p> <p>beam spread diameter in feet</p>
	BEAM SPREAD	40°	
	COLOR TEMP.	2700K	
	LUMENS	160	
	CANDLE POWER	394	
	BASE	Bi-Pin	
	LIFESPAN	50,000 Hrs.	

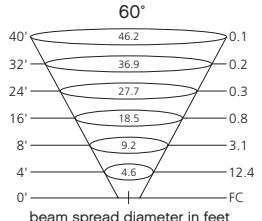
2W27K60		MR16 LED	PHOTOMETRICS
	WATTAGE	2w	 <p>60°</p> <p>beam spread diameter in feet</p>
	BEAM SPREAD	60°	
	COLOR TEMP.	2700K	
	LUMENS	160	
	CANDLE POWER	198	
	BASE	Bi-Pin	
	LIFESPAN	50,000 Hrs.	

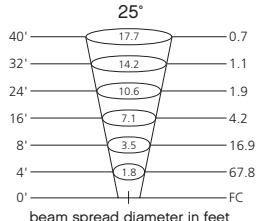
5W27K25		MR16 LED	PHOTOMETRICS
	WATTAGE	5w	 <p>25°</p> <p>beam spread diameter in feet</p>
	BEAM SPREAD	25°	
	COLOR TEMP.	2700K	
	LUMENS	300	
	CANDLE POWER	1084	
	BASE	Bi-Pin	
	LIFESPAN	50,000 Hrs.	

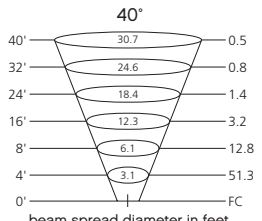
5W27K40		MR16 LED	PHOTOMETRICS
	WATTAGE	5w	 <p>40°</p> <p>beam spread diameter in feet</p>
	BEAM SPREAD	40°	
	COLOR TEMP.	2700K	
	LUMENS	300	
	CANDLE POWER	820	
	BASE	Bi-Pin	
	LIFESPAN	50,000 Hrs.	

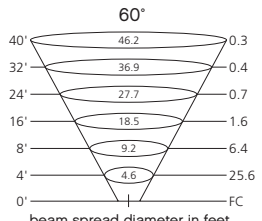
5W27K60		MR16 LED	PHOTOMETRICS
	WATTAGE	5w	 <p>60°</p> <p>beam spread diameter in feet</p>
	BEAM SPREAD	60°	
	COLOR TEMP.	2700K	
	LUMENS	300	
	CANDLE POWER	410	
	BASE	Bi-Pin	
	LIFESPAN	50,000 Hrs.	

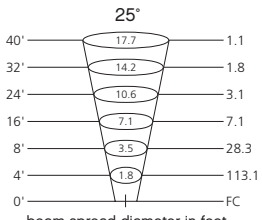
8W27K25		MR16 LED	PHOTOMETRICS
	WATTAGE	8w	 <p>25°</p> <p>beam spread diameter in feet</p>
	BEAM SPREAD	25°	
	COLOR TEMP.	2700K	
	LUMENS	500	
	CANDLE POWER	1810	
	BASE	Bi-Pin	
	LIFESPAN	50,000 Hrs.	

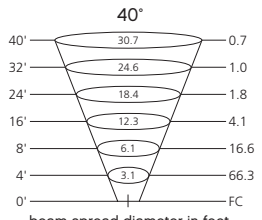
8W27K40		MR16 LED	PHOTOMETRICS
	WATTAGE	8w	 <p>40°</p> <p>beam spread diameter in feet</p>
	BEAM SPREAD	40°	
	COLOR TEMP.	2700K	
	LUMENS	500	
	CANDLE POWER	1060	
	BASE	Bi-Pin	
	LIFESPAN	50,000 Hrs.	

T3 LED REPLACEMENT	00T3-27LED	00T3-LED	
	WATTAGE	1.5w / 1.8VA	1.5w / 1.8VA
	BEAM SPREAD	360°	360°
	COLOR TEMP.	2700K	3000K
	LUMENS	140	140
	BASE	Bi-Pin	Bi-Pin
	LIFESPAN	35,000 Hrs.	35,000 Hrs.

T5 LED REPLACEMENT	00T5-27LED	00T5-LED	
	WATTAGE	1.7w / 2.0VA	1.7w / 2.0VA
	BEAM SPREAD	360°	360°
	COLOR TEMP.	2700K	3000K
	LUMENS	180	180
	BASE	Wedge	Wedge
	LIFESPAN	35,000 Hrs.	35,000 Hrs.



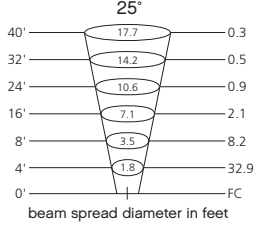

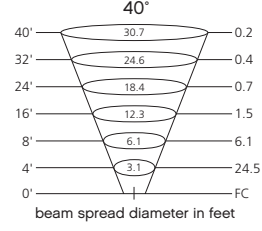
2W3K25		MR16 LED 25°	PHOTOMETRICS
	WATTAGE	2w	 <p>25°</p> <p>beam spread diameter in feet</p>
	BEAM SPREAD	25°	
	COLOR TEMP.	3000K	
	LUMENS	160	
	CANDLE POWER	527	
	BASE	Bi-Pin	
	LIFESPAN	50,000 Hrs.	

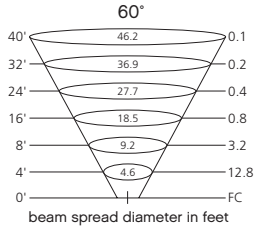
2W3K40		MR16 LED	PHOTOMETRICS
	WATTAGE	2w	 <p>40°</p> <p>beam spread diameter in feet</p>
	BEAM SPREAD	40°	
	COLOR TEMP.	3000K	
	LUMENS	160	
	CANDLE POWER	392	
	BASE	Bi-Pin	
	LIFESPAN	50,000 Hrs.	

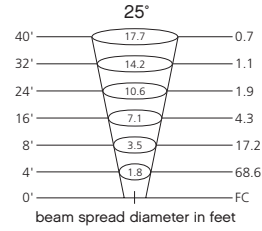
2W3K60		MR16 LED	PHOTOMETRICS
	WATTAGE	2w	 <p>60°</p> <p>beam spread diameter in feet</p>
	BEAM SPREAD	60°	
	COLOR TEMP.	3000K	
	LUMENS	160	
	CANDLE POWER	204	
	BASE	Bi-Pin	
	LIFESPAN	50,000 Hrs.	

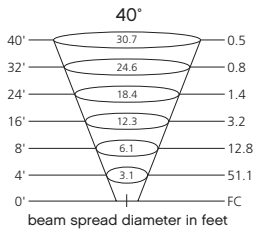
5W3K25		MR16 LED	PHOTOMETRICS
	WATTAGE	5w	 <p>25°</p> <p>beam spread diameter in feet</p>
	BEAM SPREAD	25°	
	COLOR TEMP.	3000K	
	LUMENS	320	
	CANDLE POWER	1098	
	BASE	Bi-Pin	
	LIFESPAN	50,000 Hrs.	

5W3K40		MR16 LED	PHOTOMETRICS
	WATTAGE	5w	 <p>40°</p> <p>beam spread diameter in feet</p>
	BEAM SPREAD	40°	
	COLOR TEMP.	3000K	
	LUMENS	320	
	CANDLE POWER	818	
	BASE	Bi-Pin	
	LIFESPAN	50,000 Hrs.	

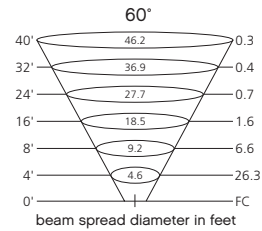
5W3K60		MR16 LED	PHOTOMETRICS
	WATTAGE	5w	 <p>60°</p> <p>beam spread diameter in feet</p>
	BEAM SPREAD	60°	
	COLOR TEMP.	3000K	
	LUMENS	320	
	CANDLE POWER	420	
	BASE	Bi-Pin	
	LIFESPAN	50,000 Hrs.	

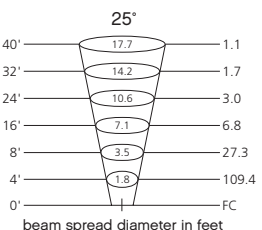
8W3K25		MR16 LED	PHOTOMETRICS
	WATTAGE	8w	 <p>25°</p> <p>beam spread diameter in feet</p>
	BEAM SPREAD	25°	
	COLOR TEMP.	3000K	
	LUMENS	510	
	CANDLE POWER	1750	
	BASE	Bi-Pin	
	LIFESPAN	50,000 Hrs.	

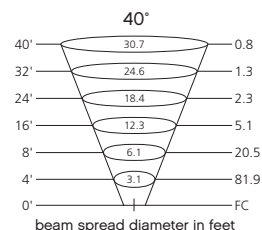
8W3K40		MR16 LED	PHOTOMETRICS
	WATTAGE	8w	 <p>40°</p> <p>beam spread diameter in feet</p>
	BEAM SPREAD	40°	
	COLOR TEMP.	3000K	
	LUMENS	510	
	CANDLE POWER	1310	
	BASE	Bi-Pin	
	LIFESPAN	50,000 Hrs.	

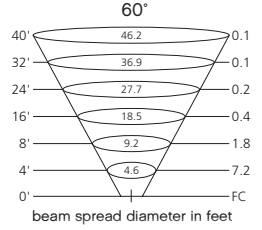
MR8LED60		MR8 LED	PHOTOMETRICS
	WATTAGE	2.5w	 <p>60°</p> <p>beam spread diameter in feet</p>
	BEAM SPREAD	60°	
	COLOR TEMP.	2700K	
	LUMENS	90	
	CANDLE POWER	115	
	BASE	Bi-Pin	
	LIFESPAN	50,000 Hrs.	

# HALOGEN BULBS

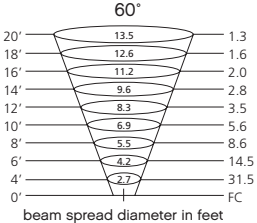
4425	PAR 36 HALOGEN		PHOTOMETRICS
	WATTAGE	25w	 <p>60°</p> <p>beam spread diameter in feet</p>
	BEAM SPREAD	60° WFL	
	COLOR TEMP.	2900	
	LUMENS	100	
	CANDLE POWER	530	
	BASE	Bi-Pin	
	LIFESPAN	1000 Hrs.	

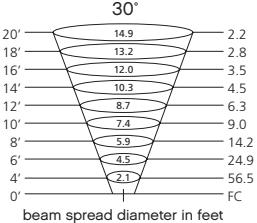
4435	PAR 36 HALOGEN		PHOTOMETRICS
	WATTAGE	35w	 <p>30°</p> <p>beam spread diameter in feet</p>
	BEAM SPREAD	30° WFL	
	COLOR TEMP.	2950	
	LUMENS	250	
	CANDLE POWER	1000	
	BASE	Bi-Pin	
	LIFESPAN	4000 Hrs.	

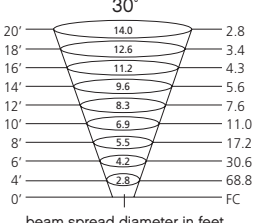
4450	PAR 36 HALOGEN		PHOTOMETRICS
	WATTAGE	50w	 <p>30°</p> <p>beam spread diameter in feet</p>
	BEAM SPREAD	30° WFL	
	COLOR TEMP.	3000	
	LUMENS	400	
	CANDLE POWER	1500	
	BASE	Bi-Pin	
	LIFESPAN	4000 Hrs.	

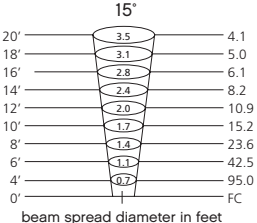
0011N10	MR11 HALOGEN		PHOTOMETRICS
	WATTAGE	10w	 <p>15°</p> <p>beam spread diameter in feet</p>
	BEAM SPREAD	15° NSP	
	COLOR TEMP.	2800	
	LUMENS	80	
	CANDLE POWER	1300	
	BASE	Bi-Pin	
	LIFESPAN	2000 Hrs.	

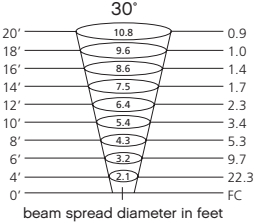
0011W10	MR11 HALOGEN		PHOTOMETRICS
	WATTAGE	10w	 <p>30°</p> <p>beam spread diameter in feet</p>
	BEAM SPREAD	30° WFL	
	COLOR TEMP.	2800	
	LUMENS	90	
	CANDLE POWER	350	
	BASE	Bi-Pin	
	LIFESPAN	2000 Hrs.	

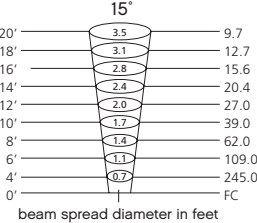
0011N20	MR11 HALOGEN		PHOTOMETRICS
	WATTAGE	20w	 <p>15°</p> <p>beam spread diameter in feet</p>
	BEAM SPREAD	15° NSP	
	COLOR TEMP.	2800	
	LUMENS	80	
	CANDLE POWER	1300	
	BASE	Bi-Pin	
	LIFESPAN	2000 Hrs.	

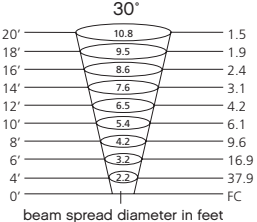
0011W20	MR11 HALOGEN		PHOTOMETRICS
	WATTAGE	20w	 <p>30°</p> <p>beam spread diameter in feet</p>
	BEAM SPREAD	30° WFL	
	COLOR TEMP.	2900	
	LUMENS	190	
	CANDLE POWER	700	
	BASE	Bi-Pin	
	LIFESPAN	2000 Hrs.	

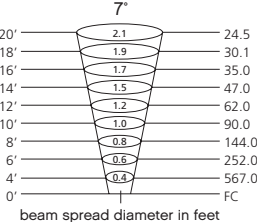
0016N20	MR16 HALOGEN		PHOTOMETRICS
	WATTAGE	20w	 <p>7°</p> <p>beam spread diameter in feet</p>
	BEAM SPREAD	7° NSP	
	COLOR TEMP.	3000	
	LUMENS	170	
	CANDLE POWER	3000	
	BASE	Bi-Pin	
	LIFESPAN	2000 Hrs.	

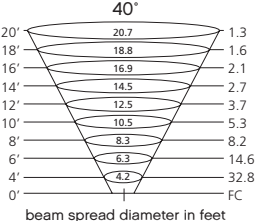
0016W20	MR16 HALOGEN		PHOTOMETRICS
	WATTAGE	20w	 <p>40°</p> <p>beam spread diameter in feet</p>
	BEAM SPREAD	40° WFL	
	COLOR TEMP.	2900	
	LUMENS	190	
	CANDLE POWER	700	
	BASE	Bi-Pin	
	LIFESPAN	2000 Hrs.	

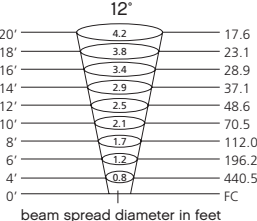
0016N35	MR16 HALOGEN		PHOTOMETRICS
	WATTAGE	35w	 <p>12°</p> <p>beam spread diameter in feet</p>
	BEAM SPREAD	12° NSP	
	COLOR TEMP.	2950	
	LUMENS	300	
	CANDLE POWER	7400	
	BASE	Bi-Pin	
	LIFESPAN	2000 Hrs.	

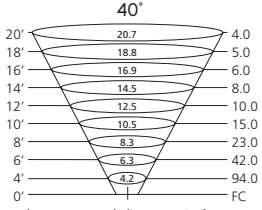
0016W35	MR16 HALOGEN		PHOTOMETRICS	
	WATTAGE	35w	 <p>beam spread diameter in feet</p>	
	BEAM SPREAD	40° WFL		
	COLOR TEMP.	2950		
	LUMENS	340		
	CANDLE POWER	1300		
	BASE	Bi-Pin		
	LIFESPAN	2000 Hrs.		

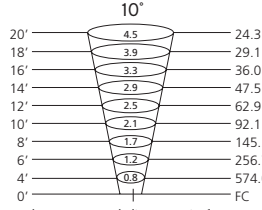
0016N50	MR16 HALOGEN		PHOTOMETRICS	
	WATTAGE	50w	 <p>beam spread diameter in feet</p>	
	BEAM SPREAD	10° NSP		
	COLOR TEMP.	3000		
	LUMENS	430		
	CANDLE POWER	8500		
	BASE	Bi-Pin		
	LIFESPAN	2000 Hrs.		

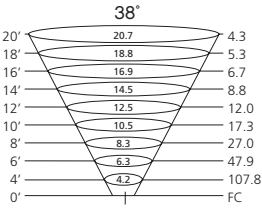
0016W50	MR16 HALOGEN		PHOTOMETRICS	
	WATTAGE	50w	 <p>beam spread diameter in feet</p>	
	BEAM SPREAD	38° WFL		
	COLOR TEMP.	3000		
	LUMENS	470		
	CANDLE POWER	1580		
	BASE	Bi-Pin		
	LIFESPAN	2000 Hrs.		

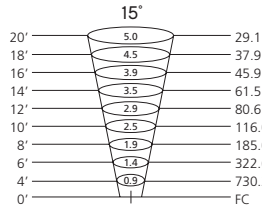
0016N75	MR16 HALOGEN		PHOTOMETRICS	
	WATTAGE	75w	 <p>beam spread diameter in feet</p>	
	BEAM SPREAD	15° NSP		
	COLOR TEMP.	3000		
	LUMENS	650		
	CANDLE POWER	11,200		
	BASE	Bi-Pin		
	LIFESPAN	2000 Hrs.		

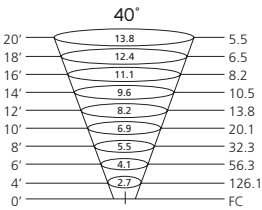
0016W75	MR16 HALOGEN		PHOTOMETRICS	
	WATTAGE	75w	 <p>beam spread diameter in feet</p>	
	BEAM SPREAD	40° WFL		
	COLOR TEMP.	3000		
	LUMENS	720		
	CANDLE POWER	1900		
	BASE	Bi-Pin		
	LIFESPAN	2000 Hrs.		

T5 WEDGE BASE	0906	0912	0921	0921X	
	WATTAGE	7w	12w	18w	18w
	BEAM SPREAD	360°	360°	360°	360°
	COLOR TEMP.	2700K	2700K	2700K	2700K
	CANDLE POWER	6	12	21	21
	BASE	Wedge	Wedge	Wedge	Wedge
	LIFESPAN	1000 Hrs.	1000 Hrs.	1000 Hrs.	1000 Hrs.

T3 & T4 HALOGEN	0020T3	0010T4	0020T4	0050T4	
	WATTAGE	20w	10w	20w	50w
	BEAM SPREAD	360°	360°	360°	360°
	COLOR TEMP.	3000K	3000K	3000K	3000K
	CANDLE POWER	320	140	320	930
	BASE	Bi-Pin	Bi-Pin	Bi-Pin	Bi-Pin
	LIFESPAN	2000 Hrs.	2000 Hrs.	2000 Hrs.	2000 Hrs.



# LED LOW VOLTAGE DESIGN + INSTALLATION

## STEP 1: MAKE A PLAN

What do you want to light? Pick favorite trees, interesting plants, fountains, statues or other attractive architectural elements. These items will be the focus of your lighting plan. Think about how you use the property. Are there areas you would like to illuminate for work, recreation or entertaining? Think about areas in which added light would enhance safety, such as steps or a wall around the side of your home.

### *helpful planning tip*

DON'T MISS THE LANDSCAPE LIGHTING TECHNIQUES ON PAGES 8-9 TO DETERMINE THE BEST METHODS FOR HIGHLIGHTING YOUR HOME'S EXTERIOR.



## STEP 2: PREPARE YOUR EQUIPMENT

### LOW VOLTAGE LED SYSTEMS

Most residential LED landscape lighting is done with 12-volt distribution. The system consists of a central transformer, weatherproof cable and low voltage LED fixtures and accessories.

### LED FIXTURES

Decide on what fixtures you will be using as part of your complete lighting plan. Choose styles you like and select the appropriate LED wattage for the application.

### TRANSFORMERS

Transformers convert your 120-volt household current to 12-volt. Outdoor transformers can be installed on the side of your house and plug into an exterior rated outlet. They must mount at least 12" above the ground.

Transformers used indoors (such as in a garage or basement) must be listed for that application. For indoor use, UL requires conduit be used when running wiring through the wall. Calculate the total volt amperage (VA) your system requires. Then choose a transformer powerful enough to handle the total VA and still have some extra capacity if fixtures will be added at a later time.

### CABLE

12-volt LED fixtures take power from a weatherproof, flexible 2-wire cable that can be used above or below ground and generally does not need to be housed in conduit or buried as deep as 120-volt wiring. 12AWG cable is minimum gauge recommended for LED installations. Measure the distance from the last fixture on the run to the transformer to calculate the amount of cable needed. Add 1-2 feet of cable per fixture to allow for repositioning.

**STEP 3: WIRING YOUR SYSTEM**

**CABLE FIXTURE AND LAYOUT**

If your lighting plan requires more than one transformer, you will need to divide the fixtures into groups or zones. To do so, consider the many areas of your property and how they are used. You may want all of the front yard lighting on one transformer, patio and deck lighting on another transformer, etc. The location of your electrical outlets will also help you to determine how to group the fixtures.

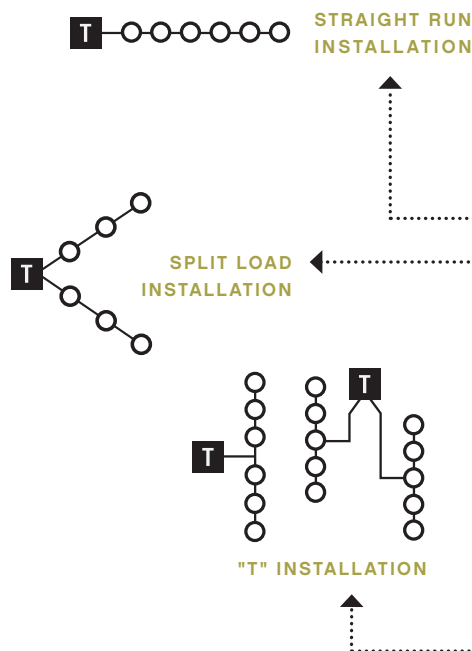

The pictured diagrams will help you wire your system. The black box represents the transformer.

**STRAIGHT RUN INSTALLATION**

Fixtures run in sequence directly from the transformer.

**SPLIT LOAD INSTALLATION**

With a Split Load installation, fixtures run in two or more directions from the transformer. Locate the transformer in the center of the run and connect wires to the transformer as you would when using straight run installation.

**"T" INSTALLATION**

A "T" installation allows more equal distribution of power to the center of the run, or to the run some distance away. For lengthy runs, use 8 or 10 AWG cable to split. Use 12 AWG cable to cross the "T" between fixtures.

**MINIMAL VOLTAGE DROP WITH LED**

LED fixtures use less amperage than incandescent, therefore more fixtures can be used in a single cable run as compared to incandescent. Each fixture has a built-in durable driver circuit that accepts a wider input voltage range (10VAC-15VAC) thus eliminating the common voltage-drop problems experienced with incandescent systems. Most fixtures can be wired in straight run installations eliminating the need to create zones or split loads. The driver in each fixture will regulate the input voltage and properly power the LED.

**VA (VOLT-AMPS) & W (WATTAGE)**

All LED fixtures are measured in wattage (the actual electric consumed by the LED) and volt-amps VA (the power supply required to operate the LED). LED drivers convert the 12V alternating current (AC) to direct current (DC) to power the LED chip(s). This additional power to change the current is measured as volt-amps (VA) for each fixture. The VA indicates the power supply or transformer requirement you will need to operate the LEDs. To properly size your transformer, add up the VA for all fixtures on the system. To calculate your energy cost, add up the measured wattage rating of each LED.

6 fixtures x 2.1 W each =  
**12.6 W total**  
(ACTUAL ENERGY CONSUMED)

6 fixtures x 3.2 VA each =  
**19.2 VA total**  
(MINIMUM TRANSFORMER REQUIRED)

*for further instructions* ON FIXTURE CONNECTION, MOUNTING AND ACCESSORIES, FOLLOW HINKLEY'S INCANDESCENT INSTALLATION INSTRUCTIONS FOUND ON PAGE 86.

# 12V LOW VOLTAGE DESIGN + INSTALLATION

## STEP 1: MAKE A PLAN

What do you want to light? Pick favorite trees, interesting plants, fountains, statues or other attractive architectural elements. These items will be the focus of your lighting plan. Think about how you use the property. Are there areas you would like to illuminate for work, recreation or entertaining? Think about areas in which added light would enhance safety, such as steps or a wall around the side of your home.

### *helpful planning tip*

DON'T MISS THE LANDSCAPE LIGHTING TECHNIQUES ON PAGES 8-9 TO DETERMINE THE BEST METHODS FOR HIGHLIGHTING YOUR HOME'S EXTERIOR.

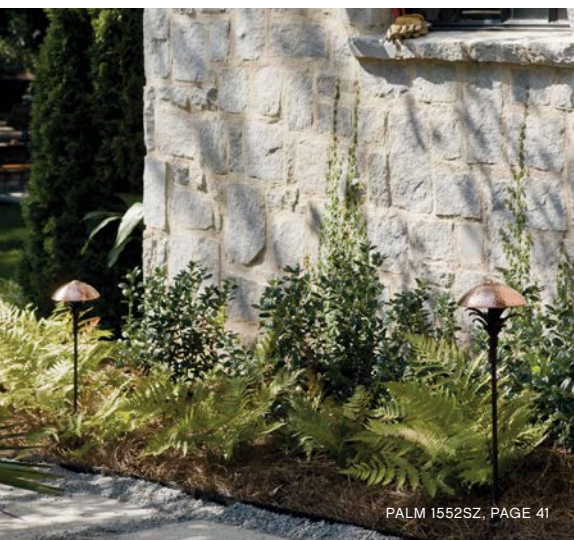

PALM 1552SZ, PAGE 41

## STEP 2: PREPARE YOUR EQUIPMENT

### LOW VOLTAGE SYSTEMS

Most residential landscape lighting is done with 12-volt distribution. The system consists of a central transformer, weatherproof cable and low voltage fixtures and accessories.

### FIXTURES

Decide on what fixtures you will be using as part of your complete lighting plan. Choose styles you like and select the appropriate wattage for the application.

### TRANSFORMERS

Transformers convert your 120-volt household current to 12-volt. Outdoor transformers can be installed on the side of your house and plug into an exterior outlet. They must mount at least 12" above the ground.

Transformers used indoors (such as in a garage or basement) must be listed for that application. For indoor use, UL requires conduit be used when running wiring through the wall. Calculate the total lamp wattage (or VA for LED) your system requires. Then choose a transformer powerful enough to handle the total wattage/VA and still have some extra capacity if fixtures will be added at a later time.

### CABLE

12-volt fixtures take power from a weatherproof, flexible 2-wire cable that can be used above or below ground and generally does not need to be housed in conduit or buried as deep as 120-volt wiring. 12AWG cable is minimum gauge recommended for LED installations. Measure the distance from the last fixture on the run to the transformer to calculate the amount of cable needed. Add 1-2 feet of cable per fixture to allow for repositioning.

## STEP 3: WIRING YOUR SYSTEM AND VOLTAGE DROP

### CABLE FIXTURE AND LAYOUT

If your lighting plan requires more than one transformer, you will need to divide the fixtures into groups or zones. To do so, consider the many areas of your property and how they are used. You may want all of the front yard lighting on one transformer, patio and deck lighting on another transformer, etc. The location of your electrical outlets will also help you to determine how to group the fixtures.

MAXIMUM CABLE LENGTH PER TOTAL FIXTURE WATTS/VA							
Cable Size	50w/VA	75w/VA	100w/VA	150w/VA	200w/VA	250w/VA	300w/VA
12-2	300'	200'	150'	100'	75'	60'	—
10-2	475'	318'	240'	160'	120'	100'	80'
8-2	750'	506'	380'	250'	190'	150'	125'



**VOLTAGE DROP**

Excessive voltage drop occurs when too much wattage is placed on a cable that is too long or too small for the load. Voltage drop causes lamps furthest from the transformer to be dimmer than those near the transformer.

To help minimize voltage drop among each group of fixtures, use the following information to assist you:

**Total Watts** = sum of the incandescent wattage on a single run of wire.

**Volt Amps** = sum of the LED VA on a single run of wire.

**Cable Length** = length of cable run (feet) from the transformer to the last fixture on that run.

**Cable Constant** = thickness of copper wire. The thicker the wire, the lower the conductive resistance, resulting in a lower drop in voltage.

**THE CABLE CONSTANT IS BASED ON WIRE SIZE. REMEMBER THAT LARGER WIRES HAVE LOWER AWG SIZES.**

CABLE CONSTANT	
Cable	Constant
18 AWG	1,380v
16 AWG	2,200v
14 AWG	3,500v
12 AWG	7,500v
10 AWG	11,920v
8 AWG	18,960v

**CALCULATING VOLTAGE DROP**

You can calculate voltage drop in volts using the formula below. It also shows the relationship of wattage/VA, run length and two-conductor cable size (given by the cable constant). Adjust lamp wattage/VA, number of fixtures per run, or the length of the run to maintain the right relationship. Example: (3) 50w fixtures on a 75 ft. run using 12 gauge wire.

**VOLTAGE DROP** =  $\frac{\text{Total Watts/VA} \times \text{Cable Length}}{\text{Cable Constant}} \times 2$

---

**EXAMPLE:**

**VOLTAGE DROP** =  $\frac{150w \times 75'}{7500 \text{ (12 AWG Cable Constant)}} \times 2$

Then, subtract the voltage drop from transformer output to operate in desired range:

**15 VOLT TAP - 3 (VOLTAGE DROP) =  
12 (ACTUAL VOLTAGE)**

Voltage should not drop below 10.8 volts. In this case you should choose higher outputs to keep voltage in desired range of 11.2 volts-11.6 volts.

Lighting fixtures will generate heat. To avoid excessive heat be sure to keep all lamps clear of dirt and debris. Input voltage at the lamp on low voltage fixtures should never exceed 12 volts.

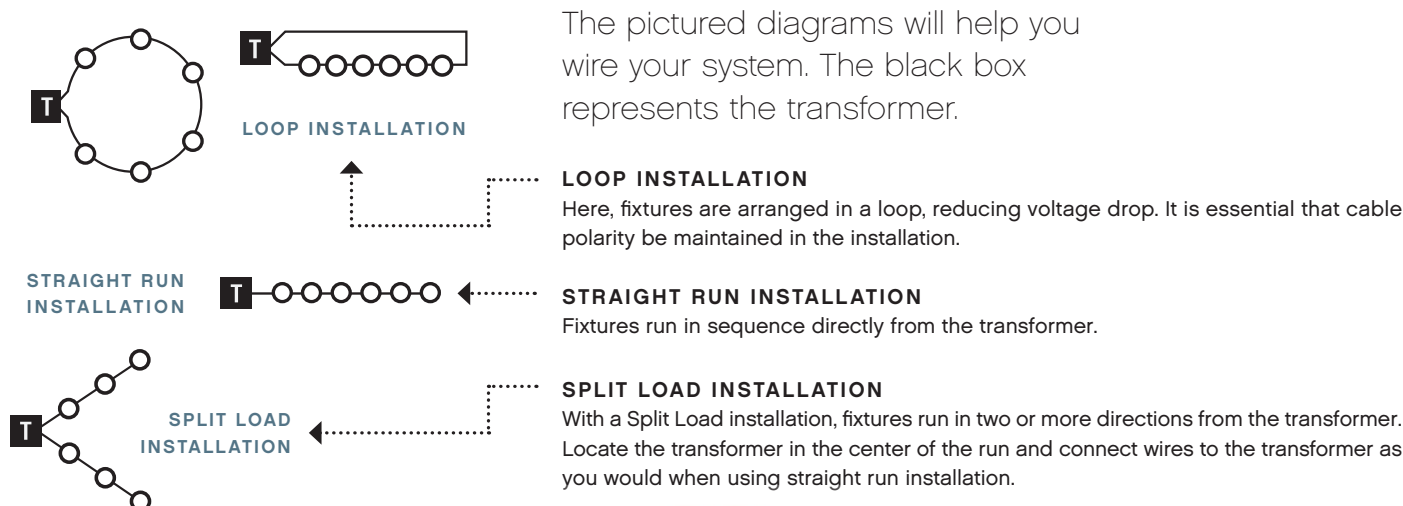

continued on next page ►

### STEP 3: WIRING YOUR SYSTEM AND VOLTAGE DROP *continued*

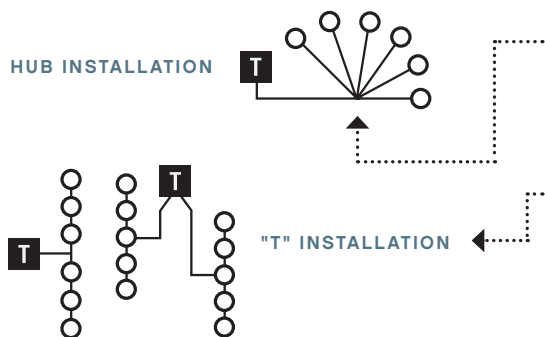

#### HUB INSTALLATION

With a Hub installation, fixtures in a group are connected at a central hub. The voltage drop will be virtually identical for each fixture, which makes this installation option optimal. Fewer connections are needed, simplifying troubleshooting and system servicing.

#### "T" INSTALLATION

A "T" installation allows more equal distribution of power to the center of the run, or to the run some distance away. For lengthy runs, Use 8 or 10 AWG cable to split. Use 12 AWG cable to cross the "T" between fixtures.

EFFECT OF VOLTAGE ON LAMP LIFE/LIGHT OUTPUT		
Voltage at Lamp	Life Expectancy of Lamp	% of Rated Candlepower
13.2	2/3 rated life	350
12.6	3/4 rated life	180
12.0	as rated	100
11.5	2 x rated	80
11.0	3 x rated	75
10.75	4 x rated	70
10.5	5 x rated	65*
10.0	9 x rated	50

\*Lowest recommended candle power output

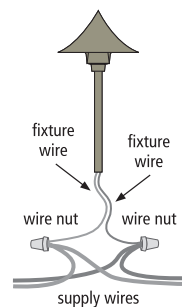

#### FIXTURE CONNECTION

Hinkley low voltage fixtures come standard with a connection kit, (2) wire nuts and silicone caulk. Fixtures should be attached by splicing them into main supply cable. Wire nuts should be filled with silicone. Twist the wires, then screw on the wire nut. Wrap with electrical tape. Bury any extra wire at the base of fixture to allow for relocation or adjustment.

After wiring your lighting plan, turn the transformer on and check the lamp voltage at each fixture.

#### MOUNTING

Hinkley low-voltage fixtures come standard with the 0014 BZ ground spike (see accessories, page 75) and can be easily relocated every several years to adjust for the natural growth of trees and plantings.

### STEP 4: CONSIDER ACCESSORIES

Controls enhance landscape lighting, just as they do interior lighting. Photocells, timers and special lenses can help control your lighting plan.

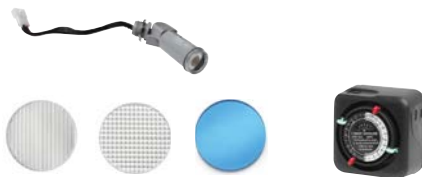

#### PHOTOCELLS

Photocells turn the lighting on when the sun goes down. You can combine a photocell (on) and a timer (off) to avoid wasting energy after the household has retired for the night.

#### TIMERS

Timers provide automatic on/off control, according to how you program them and can be used in conjunction with photocells.

#### LENSES

Hinkley lenses are available for use with spotlights to create directional beams of light, diffuse lamp beam spread, enhance color and to reduce overall glare.

for additional accessories AND CONTROLS, SEE PAGES 74-77.

# INDEX

0005BK	74	0912	83	1536MZ-5W27MD	17	1558BK-LED	37	1594BZ-LED	57	2W3K25	81
0005SC	74	0921	83	1536MZ-5W27SP	17	1558SC	37	1594MZ	57	2W3K40	81
0006-TBK	74	0921X	83	1536MZ-5WLEDFL	17	1558SC-LED	37	1594MZ-LED	57	2W3K60	81
0006-TSC	74	1403OC	41	1536MZ-5WLEDMD	17	15601BZ	28	1595BZ	24	29700VI	58
0010T4	83	15014BZ	33	1536MZ-5WLEDSP	17	15601BZ-LED	28	1599BS	24	29703VI	58
0011N10	82	15014HE	33	1536MZ-8W27FL	17	15601TT	28	16004MZ	38	29705VI	58
0011N20	82	15014TT	33	1536MZ-8W27MD	17	15601TT-LED	28	16004MZ-LED	38	29707VI	58
0011W10	82	1502BZ	31	1536MZ-8W27SP	17	15602BZ	28	16007MZ	38	4425	82
0011W20	82	1502BZ-LED	31	1536MZ-8WLEDFL	17	15602BZ-LED	28	16007MZ-LED	38	4435	82
0012-TBK	74	1503PH	76	1536MZ-8WLEDMD	17	15602TT	28	16010MZ	38	4450	82
0012-TSC	74	1505TC	76	1536MZ-8WLEDSP	17	15602TT-LED	28	16010MZ-LED	38	50200WN	71, 74
0013-JBBZ	75	1507QC	74	1538BZ	21	15604BZ	29	16012MZ	39	50300SF	71
0014BZ	75	1508CB	44	1539BS	21	15604BZ-LED	29	16012MZ-LED	39	50400HG	71
0015BZ	74	1510PH	76	1540CB	40	15604TT	29	16016MZ	39	50500PP	71
0016CB	75	1513MB	43	1542BZ	54	15604TT-LED	29	16016MZ-LED	39	51000BZ	70
0016HL	75	1515RB	43	1542BZ-LED	54	15607BK	27	16019MZ	39	51010CK	71
0016LF	75	1516MR	44	1542MZ-LED	54	15607BK-LED	27	16019MZ-LED	39	51070BZ	70
0016N20	82	1518BZ	32	15440BZ	48	15607HE	27	16022MZ	39	51901BZ	71
0016N35	82	1518BZ-LED	32	15440SW	48	15607HE-LED	27	16022MZ-LED	39	52000BZ	70
0016N50	83	1518CD-LED	32	15442BZ	48	15607KZ	27	16024MZ	39	52010CK	71
0016N75	83	1518HE	32	15442SW	48	15607KZ-LED	27	16024MZ-LED	39	52901BZ	71
0016PF	75	1518HE-LED	32	1544BK	36	15609BZ	27	16050MZ	38	53000BZ	63
0016W20	82	1518TT	32	1544BK-LED	36	15609BZ-LED	27	16055MZ	38	54000BZ	62
0016W35	83	1518TT-LED	32	1544SC	36	15609TT	27	16501MZ	19	54000BZ-LED30	62
0016W50	83	1520BZ	20	1544SC-LED	36	15609TT-LED	27	16501MZ-27K60	19	54000BZ-LED60	62
0016W75	83	1521BZ	20	15446BZ	50	1560AR	35	16507MZ	19	55000BZ	62
0017-JBBZ	75	1524BZ	53	15446BZ-10	50	15612BZ	29	16507MZ-27K60	19	56000BZ	61
0018-TBK	74	1524BZ-LED	53	15446ST	50	15612BZ-LED	29	16571MZ	19	57000BZ	61
0018-TSC	74	1524MW	53	15446ST-10	50	15612TT	29	16571MZ-LED	19	58009BZ	69
0019BZ	75	1524MW-LED	53	15446TT	50	15612TT-LED	29	16701MZ	22	58015BZ-LED	69
0020T3	83	1527CB	40	15446TT-10	50	1561AR	35	16701MZ-27K25	22	58025BZ	69
0020T4	83	1529CB	43	15450BZ	47	1561AR-LED	35	16701MZ-27K60	22	58504BZ	65
0021BZ	74	1530BZ	21	15450SW	47	1561SK	35	16701MZ-3K25	22	58504LA	65
0022BZ	74	1536BZ	18	15452BZ	47	1561SK-LED	35	16701MZ-3K60	22	58504MZ	65
0024-TBK	74	1536BZ-3W27FL	17	15452SW	47	1561TT	35	16704MZ	22	58504SW	65
0024-TSC	74	1536BZ-3W27MD	17	1546BZ	55	1561TT-LED	35	16704MZ-27K25	22	58504TT	65
0030BZ	74	1536BZ-3W27SP	17	1546BZ-LED	55	1567RY	43	16704MZ-27K60	22	58506BZ	67
0037HL	75	1536BZ-3WLEDFL	17	1546CO-LED	55	1568RB	44	16704MZ-3K25	22	58506LA	67
0050T4	83	1536BZ-3WLEDMD	17	1546MZ	55	1570FS	37	16704MZ-3K60	22	58506SW	67
0075WSS	76	1536BZ-3WLEDSP	17	1546MZ-LED	55	15711BZ	30	16707MZ	23	58506TT	67
00G2FO-FLOOD	17	1536BZ-5W27FL	17	15471BZ	46	15711TT	30	16707MZ-3K25	23	58508BZ	66
00G2FO-MEDIUM	17	1536BZ-5W27MD	17	15472BZ	46	15714BZ	30	16710MZ	23	58508LA	66
00G2FO-SPOT	17	1536BZ-5W27SP	17	15476BZ	46	15714TT	30	16710MZ-3K60	23	58508MZ	66
00G2SE-20	17	1536BZ-5WLEDFL	17	1547HE	34	1573BK	36	16801MZ	52	58508SW	66
00G2SE-35	17	1536BZ-5WLEDMD	17	1547KZ	34	1573BK-LED	36	16801MZ-LED	52	58508TT	66
00G2SE-50	17	1536BZ-5WLEDSP	17	1548BZ	31	1573SC	36	16804MZ	52	59009BZ	68
00T3-27LED	80	1536BZ-8W27FL	17	1548BZ-LED	31	1573SC-LED	36	16804MZ-LED	52	59024BZ-LED	68
00T3-LED	80	1536BZ-8W27MD	17	1548TT	31	1579MT	34	16805MZ-LED	53	59040BZ	68
00T5-27LED	80	1536BZ-8W27SP	17	1548TT-LED	31	1579SS	34	16807MZ	74	5W27K25	80
00T5-LED	80	1536BZ-8WLEDFL	17	1549BZ	52	1580DT	76	16814BZ	75	5W27K40	80
0100FT	74	1536BZ-8WLEDMD	17	1549BZ-LED	52	1583NC	21	16814MZ	75	5W27K60	80
0150BK	76	1536BZ-8WLEDSP	17	1549MW	52	15903BZ	46	16902MZ	74	5W3K25	81
0150SS	76	1536BZ-DN	18	1549MW-LED	52	15903SW	46	16910MZ	74	5W3K40	81
0250FT	74	1536MZ	18	15508BZ	51	15906BZ	46	16918MZ	74	5W3K60	81
0251FT	74	1536MZ-3W27FL	17	15508MZ	51	15906SW	46	16990MZ	74	8W27K25	80
0300SS	76	1536MZ-3W27MD	17	15508SW	51	1590BZ	24	27G2SE-20	17	8W27K40	80
0500FT	74	1536MZ-3W27SP	17	15508TT	51	15912BZ	46	27G2SE-35	17	8W3K25	81
0516FT	74	1536MZ-3WLEDFL	17	1552SZ	41	15918BZ	46	27G2SE-50	17	8W3K40	81
0600SS	76	1536MZ-3WLEDMD	17	1554SZ	44	15924BZ	46	2W27K25	80	MR8LED60	81
0900SS	76	1536MZ-3WLEDSP	17	1555CB	40	1593OB	41	2W27K40	80		
0906	83	1536MZ-5W27FL	17	1558BK	37	1594BZ	57	2W27K60	80		





*life*AGLOW®

## THIS IS HINKLEY

### *At your fingertips* | AWARD-WINNING CATALOGS

Check out our full range of products in easy-to-use, full color catalogs complete with sizing guidelines, design ideas and eco-tips.

### *Information 24/7/365* | DYNAMIC WEBSITE

[hinkleylighting.com](http://hinkleylighting.com)

Surf all of the details on our lighting collections, including the newest products from Hinkley and Fredrick Ramond, tips from professional designers and locate a Hinkley showroom in your area.

### *Make the world a better place* | COMMUNITY INVOLVEMENT

The Hinkley Lighting family proudly supports breast cancer initiatives. By increasing awareness and supporting education and community events, together we can work towards finding a cure. Hinkley also supports a variety of other charitable organizations that strive to make a positive difference in the lives of others. Visit [hinkleylighting.com](http://hinkleylighting.com) for more information.

### *Be inspired* | ENGAGING VIDEOS

[youtube.com/hinkleylightinginc](http://youtube.com/hinkleylightinginc)

Visit Hinkley on YouTube to watch our product, educational and brand videos.

### *Talk is chic* | SOCIAL MEDIA

See what captivates us:

[facebook.com/hinkleylighting](http://facebook.com/hinkleylighting)

[pinterest.com/hinkleylighting](http://pinterest.com/hinkleylighting)

[houzz.com/hinkleylighting](http://houzz.com/hinkleylighting)

[instagram.com/hinkleylighting](http://instagram.com/hinkleylighting)

[twitter.com/hinkleylighting](http://twitter.com/hinkleylighting)



## HINKLEY LANDSCAPE LIGHTING WARRANTY

Hinkley Landscape Lighting products have been manufactured under the highest standards of quality and workmanship. All Hinkley Landscape Lighting fixtures are warranted against defects in materials and workmanship for a period of five (5) years from the date of shipment, unless otherwise noted below.

### **HARDY ISLAND™ SERIES**

Lifetime limited warranty

### **STANDARD HOUSING**

5 year limited warranty

### **ELECTRICAL COMPONENTS & SOCKETS**

3 year limited warranty

### **LED LAMPS**

5 year limited warranty

### **INTEGRATED LED COMPONENTS**

10 year limited warranty

### **PRO-SERIES™ TRANSFORMER**

Lifetime limited warranty

### **STANDARD TRANSFORMER**

10 year limited warranty

For further details concerning this limited warranty coverage, please refer to the "Warranty" information section of [hinkleylighting.com](http://hinkleylighting.com) or consult a qualified Hinkley Landscape Lighting distributor.

All fixtures in this catalog are either UL-listed or ETL-listed for compliance with low voltage lighting standards.



©2016 Hinkley Lighting, Inc.  
All rights reserved in all copyrightable works.

Several Hinkley Lighting products are protected under U.S. Patent and foreign patent, or patent pending. For current information regarding Hinkley Lighting's patent portfolio, please visit [hinkleylighting.com](http://hinkleylighting.com).

Consistent with our corporate strategy, we have printed this catalog using vegetable-based inks, paper made with wind power and FSC® certified paper which consists of 10% post-consumer recovered fiber.

According to the Mohawk Environmental Calculator, our paper selection preserves 32 trees for the future, saves 14,903 gallons of wastewater flow and prevents 2,748 lbs of greenhouse gases from being emitted into the atmosphere. Please consider joining our environmental efforts and recycling this catalog.



Hinkley Lighting is a proud partner of the American Lighting Association.

# HINKLEY

L I G H T I N G

CLASSIC, CHIC COLLECTIONS | [HINKLEYLIGHTING.COM](http://HINKLEYLIGHTING.COM)



## FREDRICK RAMOND

ESTABLISHED 1965

HINKLEY'S LUXURY LINE | [FREDRICKRAMOND.COM](http://FREDRICKRAMOND.COM)

33000 PIN OAK PARKWAY | AVON LAKE, OHIO 44012  
PHONE (440) 653 5500 | FAX (440) 653 5555  
SHOWROOM 3210 | DALLAS TRADE MART | DALLAS, TEXAS 75207

2016 LANDSCAPE  
CATALOG

LS16

