

COLLECTION CATALOGUE

Moonline, The Running Magnet 2.0, Circle of Light,
Light Cut, Mini Beam, Thin Led, Led Curtain,
Led Squad, Light Bell, Super Flat, Sun,
Tubular Bells, Wall System, Find Me, Belvedere,
Fort Knox, Compass, Solid Pure, Pure, LightLight®,
Kap, Light Sniper, Compass Box, Battery,
Led Pipes, Decofix, Wan, Light Soldier, Downtown,
Downlights, G-O, TheBlockOfLight, Giano,
Box, Neutron, Faretto, Stealth.

ARCHITECTURAL LIGHTING

Juncos, Apps, Wall Rupture, Uso, Uso Cove Lighting,
Wall Piercing, Uso Boob, G-O In, Soft Spun,
Abajourd'hui, Teardrop, Benguerra, Usl, Usl QR-111,
Usl Pluto, Round, Square & Vertical Light,
Usb Round & Square Light, Usb Box, Softprofile,
Kaprofile, Lightlight® In System Profile,
Usp, Usl Out, Usl 900 Disk.

ESPAÑOL / ENGLISH

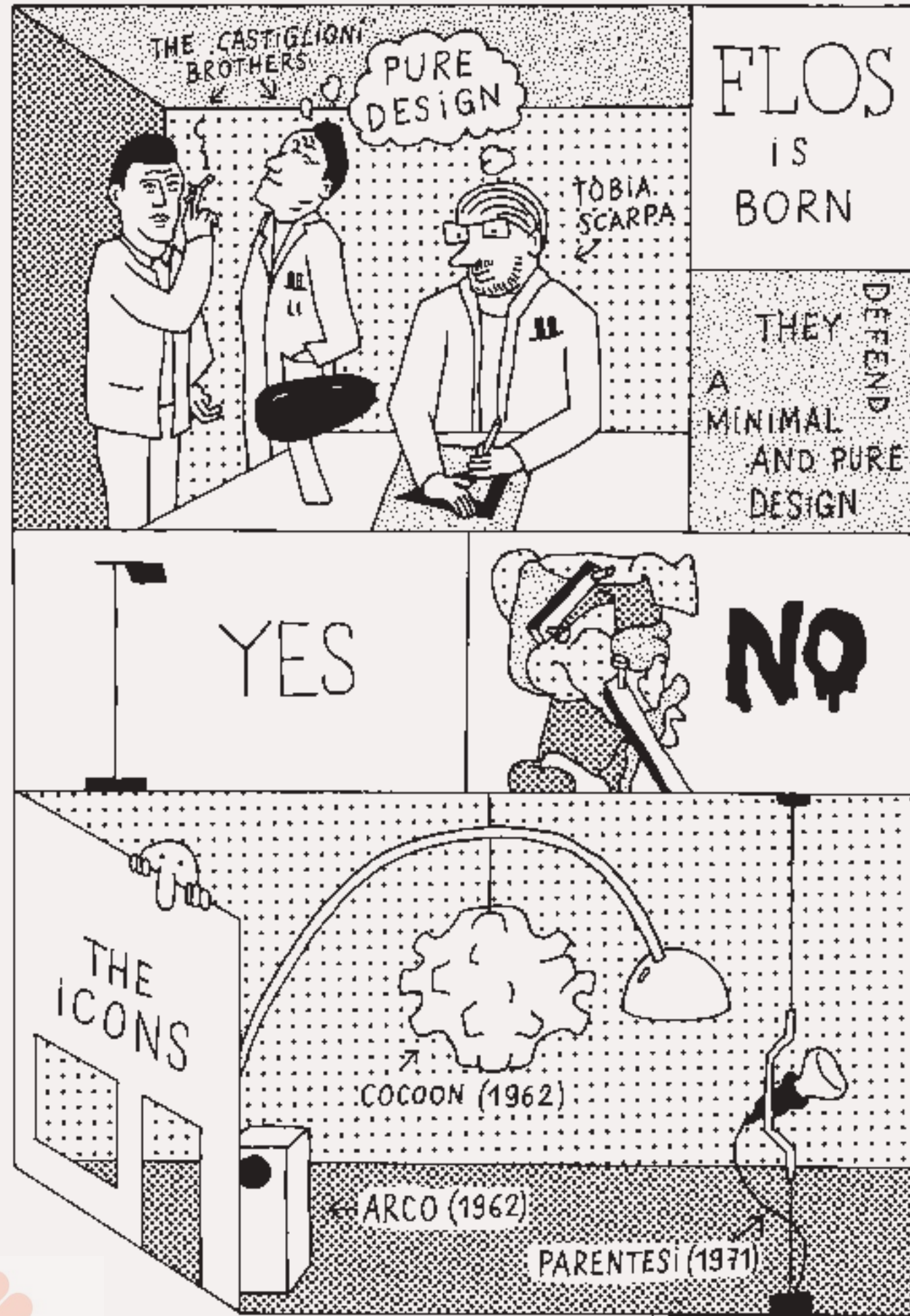



FLOS

INDEX BY FAMILY

14 - MOONLINE



26 - THE RUNNING MAGNET 2.0



38 - CIRCLE OF LIGHT



48 - LIGHT CUT

Light Cut



Light Cut Mini



66 - MINI BEAM



76 - THIN LED



86 - LED CURTAIN

LED Curtain



Soft LED Curtain Recessed



96 - LED SQUAD



106 - LIGHT BELL



120 - SUPER FLAT



130 - SUN



140 - TUBULAR BELLS

Tubular Bells



Tubular Bells Pro



156 - WALL SYSTEM



168 - FIND ME



178 - BELVEDERE



186 - FORT KNOX

For Knox Spot



For Knox Wall



202 - COMPASS

Compass Spot



Compass



218 - SOLID PURE



228 - PURE

Pure Spot



Pure Downlight



246 - LIGHTLIGHT®

Lightlight® Wall



Lightlight® Pend/
Ceiling



Lightlight® Mono



268 - K A P

Easy Kap



Kap Downlight



Kap Surface/
Suspension



292 - LIGHT SNIPER



304 - COMPASS BOX

Compass Box
Surface



Compass Box T5
Suspension



Compass Box
Recessed



INDEX BY FAMILY

324 - BATTERY

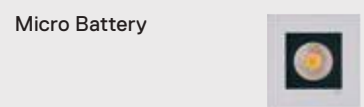
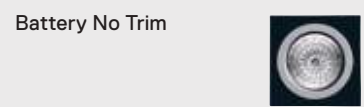
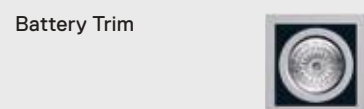

342 - LED PIPES



350 - DECOFIX



360 - WAN

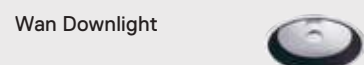
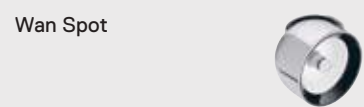

370 - LIGHT SOLDIER



378 - DOWNTOWN



386 - DOWNLIGHTS

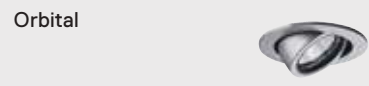
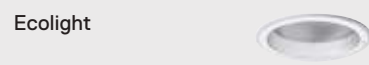
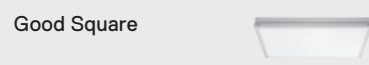

402 - G - O



414 - THEBLOCKOFLIGHT



424 - GIANO



434 - BOX



444 - NEUTRON



456 - FARETTO



464 - STEALTH



SOFT - 3D

480 - JUNCOS

- 1L
- 3L
- 6L
- 9L



SOFT - IN

490 - APPS



SOFT - LINEAR

498 - WALL RUPTURE



SOFT - IN

504 - USO

- USO Kap 105
- USO Kap 145
- USO 330 for Modular Ceiling
- USO 332
- USO 332 for Modular Ceiling
- USO 400
- USO 500
- USO 600
- USO 600 for Modular Ceiling
- USO 700
- USO 800
- USO 1000
- USO 1400



INDEX BY FAMILY

SOFT - IN

514 - USO COVE LIGHTING

- 900
- 1700
- 2200
- 2500
- 100 50
- 140 90



SOFT - 3D

520 - WALL PIERCING

- 1x
- 2x
- 4x
- 2x Line



SOFT - OUT

528 - USO BOOB

- 600 1L
- 600 for Modular Ceiling
- 600 2L
- 100 1L



SOFT - IN

536 - G - O IN



SOFT - 3D

542 - SOFT SPUN

- Halogen Small
- Halogen Large
- Fluorescent Small
- Fluorescent Large
- LED Small
- LED Large



INDEX BY FAMILY

SOFT - 3 D

550 - ABAJOURD'HUI

Small
Large



SOFT - IN

558 - TEARDROP

Small
Medium
Large



SOFT - 3 D

564 - BENGUERRA



SOFT - 3 D

568 - USL 3 D

USL 800
USL 1000
USL 1400
USL 160 71

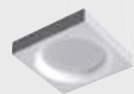

SOFT - 3 D

571 - USL 111

USL 111 Suspension
USL 111 Recessed



SOFT - 3 D

572 - USL PLUTO

USL 100 Pluto
USL 200 Pluto



SOFT - IN

576 - ROUND LIGHT

Small
Medium
Large



SOFT - IN

579 - SQUARE LIGHT

Small
Large



SOFT - IN

579 - VERTICAL LIGHT

Small
Large



SOFT - IN

584 - USB ROUND

1L
1L W-W
2L
2L W-W



SOFT - IN

587 - USB SQUARE

1L
1L W-W
2L
2L W-W



INDEX BY FAMILY

SOFT - IN

588 - USB BOX

Round 210



SOFT - LINEAR

592 - SOFTPROFILE

Smooth Small
Smooth Large
Deco Starck Small
Deco Starck Large
Deco Wanders Small
Deco Wanders Large



SOFT - LINEAR

600 - KAPPROFILE



SOFT - LINEAR

606 - LIGHTLIGHT® IN SYSTEM PROFILE

Surface
Flushed
W-W



SOFT - LINEAR

610 - USP

01 18 06
01 18 15
06 18 31
09 18 25
12 33 21
02 08 12
02 16 12
06 16 31
09 16 25
11 08 12
11 16 12
13 15 25
14 15 25
03 15 25
07 15 25
08 15 25
10 05 05



SOFT - OUT

618 - USL OUT

USL 6031
USL 6031 Recessed
USL 6060 for
Modular Ceiling













SOFT - OUT

622 - USL 900 DISK



INDEX BY PRODUCT
ALPHABETICAL ORDER

ARCHITECTURAL

- 328 – Battery 
- 182 – Belvedere 
- 438 – Box 
- 42 – Circle of Light 
- 206 – Compass 
- 308 – Compass Box 
- 354 – Decofix 
- 382 – Downtown 
- 396 – Ecolight 
- 460 – Faretto 
- 172 – Find Me 
- 190 – Fort Knox 
- 406 – G-O 









- 428 – Giano 
- 390 – Good Square 
- 272 – Kap 
- 90 – LED Curtain 
- 346 – LED Pipes 
- 100 – LED Squad 
- 110 – Light Bell 
- 52 – Light Cut 
- 250 – Lightlight® 
- 296 – Light Sniper 
- 374 – Light Soldier 
- 70 – Mini Beam 
- 18 – Moonline 

- 448 – Neutron 
- 400 – Orbital 
- 232 – Pure 
- 222 – Solid Pure 
- 468 – Stealth 
- 134 – Sun 
- 124 – Super Flat 
- 418 – TheBlockofLight 
- 30 – The Running Magnet 2.0 
- 80 – Thin LED 
- 144 – Tubular Bells 
- 160 – Wall System 
- 364 – Wan 

- 554 – Abajourd'Hui 
- 492 – Apps 
- 566 – Benguerra 
- 538 – G-O In 
- 482 – Juncos 
- 602 – Kaprofile 
- 608 – Lightlight® In System Profile 
- 578 – Round Light 
- 544 – Soft Spun 

INDEX BY PRODUCT
ALPHABETICAL ORDER

SOFT ARCHITECTURE

- 594 – Softprofile 
- 579 – Square Light 
- 560 – Teardrop 
- 590 – USB Box 
- 586 – USB Round 
- 587 – USB Square 
- 570 – USL 3D 
- 624 – USL 900 Disk 
- 620 – USL Out 

- 572 – USL Pluto 
- 571 – USL 111 
- 506 – USO 
- 532 – USO Boob 
- 514 – USO Cove Lighting 
- 612 – USP 
- 579 – Vertical Light 
- 524 – Wall Piercing 
- 500 – Wall Rupture 

Moonline, The Running Magnet 2.0, Circle of Light,
Light Cut, Mini Beam, Thin Led, Led Curtain,
Led Squad, Light Bell, Super Flat, Sun,
Tubular Bells, Wall System, Find Me, Belvedere,
Fort Knox, Compass, Solid Pure, Pure, LightLight[®],
Kap, Light Sniper, Compass Box, Battery,
Led Pipes, Decofix, Wan, Light Soldier, Downtown,
Downlights, G-O, TheBlockOfLight, Giano,
Box, Neutron, Faretto, Stealth.

ARCHITECTURAL LIGHTING

Moonline le acerca una revolucionaria tecnología de iluminación. El diseño sencillo y delgado de esta línea luminosa ofrece a los arquitectos un confort tecnológico y lumínico muy formalista. Las bandas luminosas se integran perfectamente en la arquitectura y realzan el diseño arquitectónico. La iluminación arquitectónica completamente integrada ya es una realidad. Moonline presenta una nueva cultura de la iluminación con posibilidades visuales sin precedentes. La tecnología inteligente es el reflejo de un desarrollo sostenible: los perfiles estructurales abiertos permiten una fácil integración en cualquier superficie; los módulos LED se sustituyen rápidamente gracias a un ingenioso sistema magnético. La profundidad mínima de montaje es de solo 5cm. Las casi infinitas combinaciones de acoplamiento tridimensional le ofrecen una libertad sin precedentes para desarrollar su creatividad.

MOONLINE

With Moonline a revolutionary lighting technology beckons you. The slim and clean light line offers both technological and very formalistic light comfort. The strip lights fall perfectly, and together with the architecture, enhances the architectural design. With Moonline a fully integrated Architectural Lighting is a true reality offering unprecedented and numerous visual possibilities. The smart technology is a reflection of a sustainable development and the structural open profiles allow themselves to be incorporated effortlessly into any surface requiring only a minimal depth of 5cm. The replacement of the LED modules occurs instantly with an ingenious magnet click system allowing endless three-dimensional coupling combinations to give an unprecedented freedom to your creative ambitions.



PRIVATE HALL - ITALY



Luminaria de interior para empotrar en pared/techo de cartón yeso que se integra perfectamente en el espacio estructural. Moonline se compone de perfiles de aluminio extruido sobre el que se posicionan, mediante un sistema de fijación magnética, módulos de iluminación con fuentes de luz LED de última generación. Debido al sistema de fijación magnética, los módulos de luz se pueden instalar y reubicar fácilmente, sin necesidad de herramientas específicas. Los módulos de iluminación están disponibles en 500mm y 150mm de longitud con difusor PMMA opal que garantiza una iluminación uniforme.

Recessed luminaire for indoor use, mounted on plasterboard ceiling/wall, which integrates perfectly into the structural space. Moonline is comprised of extruded aluminium profiles with natural anodised finish. It has a magnetic fixture system that houses the lighting modules, with latest generation LED light sources. Due to this magnetic fixture system, the light modules can be easily installed and repositioned, without the need for specific tools. The lighting modules are available in lengths of 500mm and 150mm with opal PMMA diffuser that guarantees uniform lighting.

Colores
Colours

00 Imprimación
00 Primer

40 Blanco
 40 White

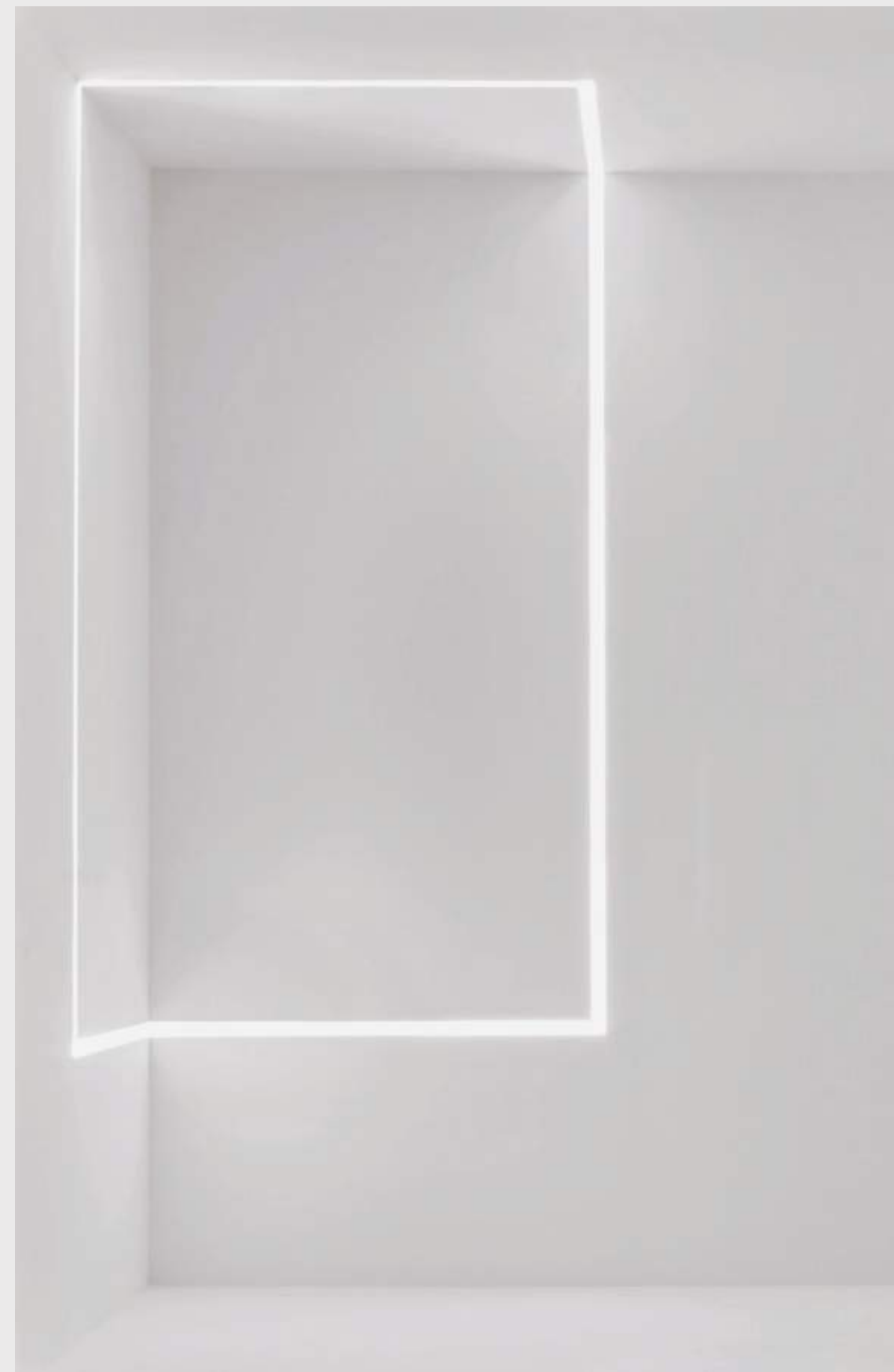

Perfiles / Profiles

Perfil realizado en aluminio extruido para empotrar en techos/paredes de cartón yeso. Integra pista magnética para la instalación directa de los módulos de iluminación LED.

Profile made of extruded aluminium to recess into plasterboard walls/ceilings. It includes magnetic track to directly install LED lighting modules.

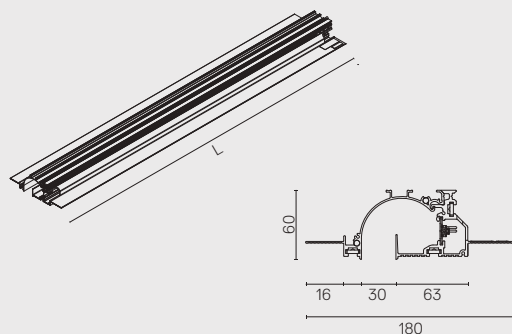

Esquina Vertical / Vertical Corner

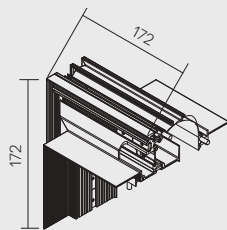

Esquina Horizontal / Horizontal Corner

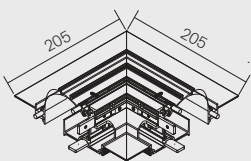

Esquina Exterior / Outer Corner

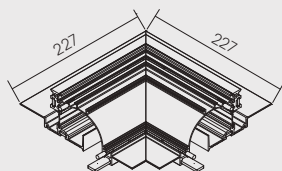

Accesorio Tapa / Accessory Endcap

Tapa metálica para los perfiles.
Metal cover for profiles.



Perfiles Perimetrales / Perimeter Profile

Perfil perimetral realizado en aluminio extruido para empotrar en techos/paredes de cartón yeso. Integra pista magnética para la instalación directa de los módulos de iluminación LED.

Perimeter profile made of extruded aluminium to recess into plasterboard walls/ceilings. It includes magnetic track to directly install LED lighting modules.

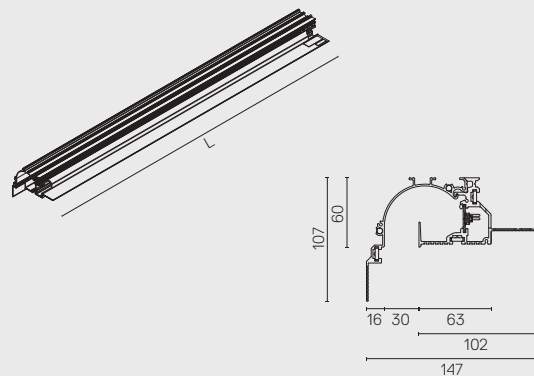

Esquina Perimetral Vertical / Vertical Perimeter Corner

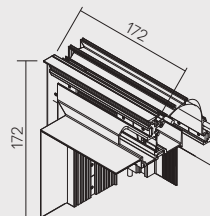

Esquina Interior Perimetral / Inner Perimeter Corner

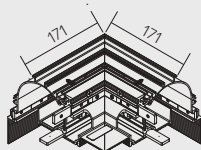

Esquina Exterior Perimetral / Outer Perimeter Corner

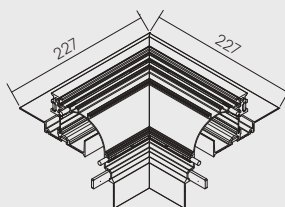

Cable de Alimentación / Connection Cable

Cable de conexión a fuente de alimentación. 1m.
Connection cable. 1m.



**MOONLINE
LIGHT STRIP 125mm**



TOP LED
2,5W
182 1m
3000K
CRI 80

**MOONLINE
LIGHT STRIP 500mm**



TOP LED
10W
728 1m
3000K
CRI 80

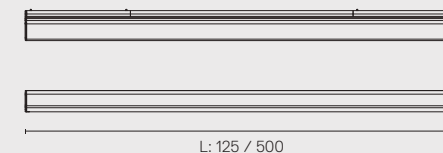

L: 125 / 500



PRIVATE HALL - ITALY



Sistema de iluminación LED dotado de la más alta tecnología para la arquitectura de interiores. The Running Magnet 2.0 se compone de perfiles que se integran en paredes/techos de cartón yeso de 12,5mm de espesor sobre los que se alojan pistas de grafito que garantizan una perfecta conexión eléctrica. El sistema se completa con módulos lineales y puntuales de iluminación ambiental que se instalan en los perfiles eléctricos mediante fijación magnética. Todo el sistema funciona a baja tensión de alimentación 24V/max 8A/max 185W, y todas las luminarias están disponibles en versiones Dali o regulable con potenciómetro. La capacidad de incorporar y redistribuir fácilmente los puntos de luz, junto con su elegante integración en la arquitectura, hace del Running Magnet 2.0 un producto novedoso y versátil.

THE RUNNING MAGNET 2.0

A high-tech LED lighting system for interior architecture. The Running Magnet 2.0 comprises electromechanical structural profiles for suspended, surface, or recessed mounting into 12.5mm thick plasterboard walls/ceilings. Ambient light strip modules, accent spot lights and decorative luminaries mounted into the profiles with exclusive secure magnetic fixing complete the system. The entire system works with 24V/max 8A/max 185W low voltage power supply and all luminaries are available in dimmable Dali version or with on board dimmer for standard installation. The flexibility of easily repositioned light sources, combined with elegant architectural integration, makes The Running Magnet 2.0 a unique and extremely versatile product.



PRIVATE HOUSE - ITALY

THE RUNNING MAGNET 2.0



Innovador sistema de iluminación para interior en versiones empotrada, superficie o suspendida. Compuesto por perfilera magnética donde se posicionan, mediante sistema de fijación magnética, módulos de iluminación.

Todos los perfiles estructurales del Running Magnet 2.0 han sido fabricados con perfilera de aluminio extruido en blanco y negro, provisto de pistas eléctricas de grafito alimentadas a 24V, sobre las cuales se instalan mediante un sistema de fijación magnética las luminarias LED.

La versión suspendida también está disponible para luz indirecta.

La familia Running Magnet 2.0 se completa con módulos de iluminación ambiental y de acento, con diferentes ópticas además de luminarias decorativas acorde a la mayoría de las colecciones Flos.

Los módulos de iluminación incorporan un sistema de fijación magnética que permite una completa movilidad y flexibilidad. Todos los módulos de luz disponen de un potenciómetro instalado o regulación DALI según se desee.

Innovative lighting system for indoor use, for recessed, surface or suspended mounting on plasterboard walls or ceilings, comprising a series of magnetic tracks that house the LED lighting modules.

The profile of all The Running Magnet 2.0 structural tracks is extruded aluminum, painted black or white, housing a graphite electric track fed at 24V, on which all magnetic luminaires are installed simply by insertion.

Suspended track is also available with the option of indirect lighting.

The system also has ambient and accent lighting modules, with different optics, and decorative luminaires like most Flos collections.

The lighting modules incorporate a magnetic mounting system for total mobility and flexibility. All light modules are available with on board potentiometer or in the DALI dimmable option.

Colores
Colours

RECESSED



■ 14 Negro
■ 14 Black

SURFACE



□ 40 Blanco
□ 40 White

SUSPENSION
UP&DOWN / DOWN



■ 14 Negro
■ 14 Black

THE RUNNING MAGNET 2.0

LIGHT MODULES

LIGHT STRIP



TOP LED
3000K
CRI 85

SPOT MODULE



POWER LED
8W
550 1m
2700K/CRI 90
750 1m
3000K/CRI 80

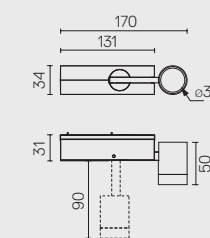
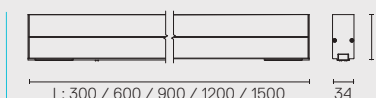

MINI GLO-BALL



MINI GLO-BALL S



POWER LED
10,8W
2700K/CRI 80
3000K/CRI 80



POWER LED
6,5W
2700K/CRI 80
3000K/CRI 80

ROMEO BABE K



ROMEO BABE K S



ROMEO BABE SOFT



ROMEO BABE SOFT S



POWER LED
6,5W
2700K/CRI 80
3000K/CRI 80

FIND ME SUSPENSION



POWER LED
8W
460 1m
2700K/CRI 90
687 1m
3000K/CRI 80

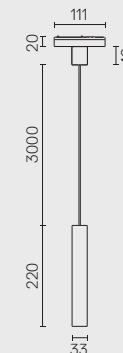
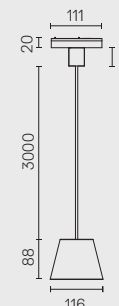
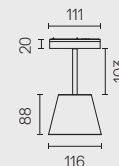
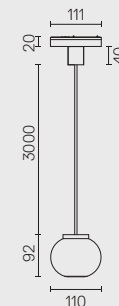
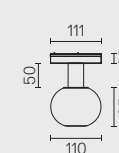

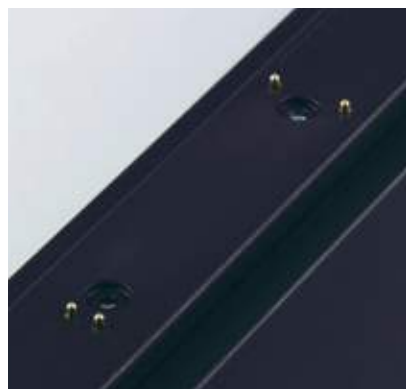

Sistema de fijación magnética que permite la instalación de los módulos de luz sin cables.

Magnetic fixture system that permits installing light modules without cable.



Gran adaptabilidad al espacio al disponer de corners pared-pared (mismo plano / distinto plano) y pared-techo.

Adapts very well to the space as it has wall-wall (same plane / different plane) and wall-ceiling corner pieces.

Detalles de Aplicación
Application Details

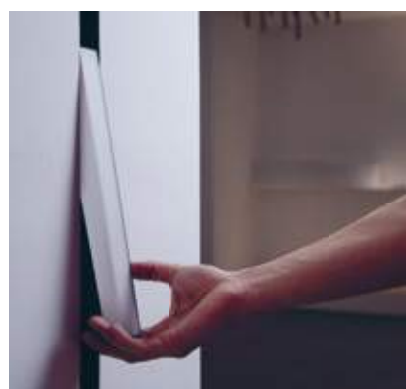
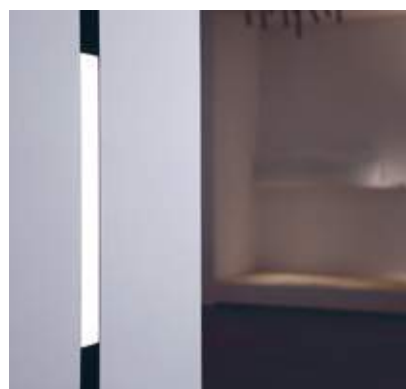

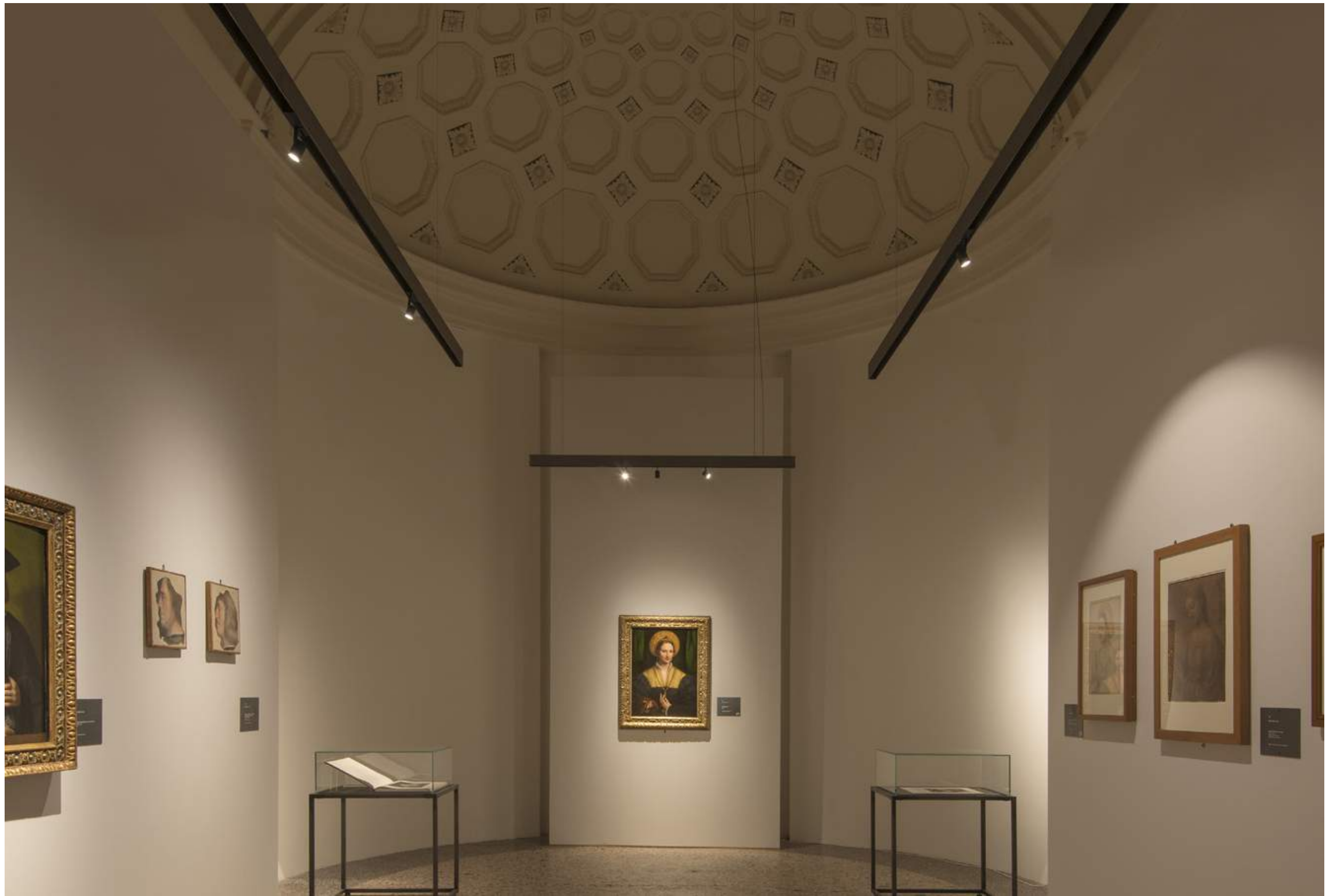

BERNARDINO LUINI EXHIBITION - MILANO



PRIVATE BANK - GERMANY

Familia de luminarias circulares para empotrar en techo, que se integran totalmente gracias a la tecnología Soft Architecture. El Circle of Light se compone de un marco exterior realizado en composite sobre el que se aloja una estructura metálica que sirve de soporte para los proyectores LED de última generación. Dispone de lentes que optimizan la eficiencia lumínica de la luminaria junto con conos anti deslumbramiento que garantizan un alto confort visual.

CIRCLE OF LIGHT

Family of circular ceiling-mounted recessed luminaires, which are totally integrated owing to Soft Architecture technology. The Circle of Light is comprised of an outer frame made with composite that houses a metal structure. This, in turn, acts as support for the latest generation LED spotlights. Its lenses optimise the luminous performance of the luminaire together with anti-glare cones that guarantee high visual comfort.





PRIVATE HALL ENTRANCE - SPAIN

CIRCLE OF LIGHT

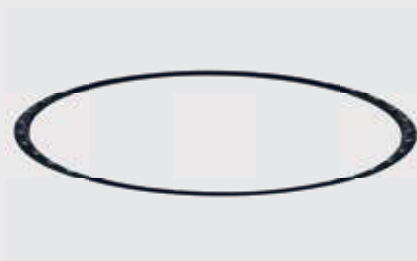

Luminaria empotrada de interiores con una fácil instalación en techos de cartón yeso, formada por una estructura circular sobre la cual viene posicionado un módulo de iluminación LED, reproducido a lo largo de su perímetro.

El producto se suministra pre-instalado sobre un perfil tipo "Soft Architecture" para garantizar su fácil montaje y perfecta integración en el techo. Mediante un sistema de fijación magnética las labores de instalación de los módulos de luz, así como futuras operaciones de mantenimiento, se pueden realizar sin la necesidad de herramientas específicas.

El Circle of Light está disponible en tres diámetros: 300, 600 y 900mm formados por 12, 24 ó 36 proyectores respectivamente.

A lighting system for indoor application comprised of a circular metal structure on which individual LED lighting spots are placed. The fitting is pre-wired and comes with a "Soft Architecture" type frame for an easy and seamless installation on the plasterboard ceiling.

The LED lighting modules are attached with a magnet for an easy mounting and for the maintenance no special tools are needed.

The Circle of Light is available in three diameters: 300, 600 or 900mm comprised of 12, 24 or 36 Led Lighting Spots, according to each size.

Colores Colours

■ 14 Negro
■ 14 Black



Premios Awards



reddot design award
winner 2013

CIRCLE OF LIGHT

CIRCLE OF LIGHT
300mm



POWER LED
12x3W
12x185 1m
2700K/CRI 90

12x3W
12x268 1m
3000K/CRI 80

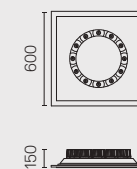

CIRCLE OF LIGHT
600mm



POWER LED
24x3W
24x185 1m
2700K/CRI 90

24x3W
24x268 1m
3000K/CRI 80

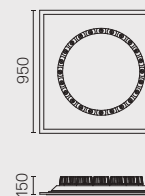

CIRCLE OF LIGHT
900mm



POWER LED
36x3W
36x185 1m
2700K/CRI 90

36x3W
36x268 1m
3000K/CRI 80

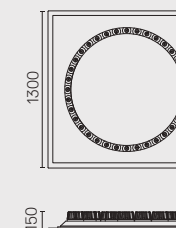

CIRCLE OF LIGHT

CIRCLE OF LIGHT



Preinstalación sobre un perfil tipo "Soft Architecture" para una perfecta integración en el techo.

Pre-installation on "Soft Architecture" type profile for perfect integration into ceiling.



Cono apantallador para un mayor cut-off y mejorar el confort visual.

Cut-off cone for greater cut-off and enhancement of visual comfort.

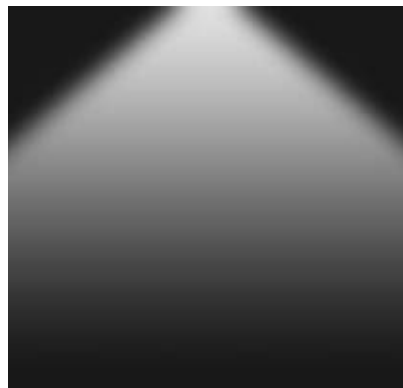

Iluminación general.

General lighting.

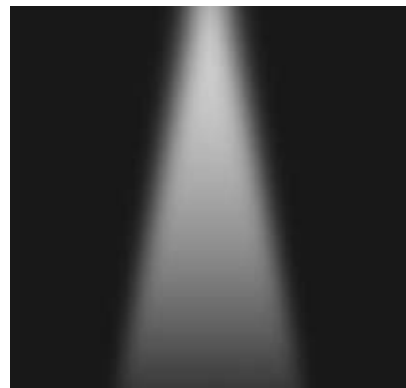

Iluminación de acento.

Accent lighting.

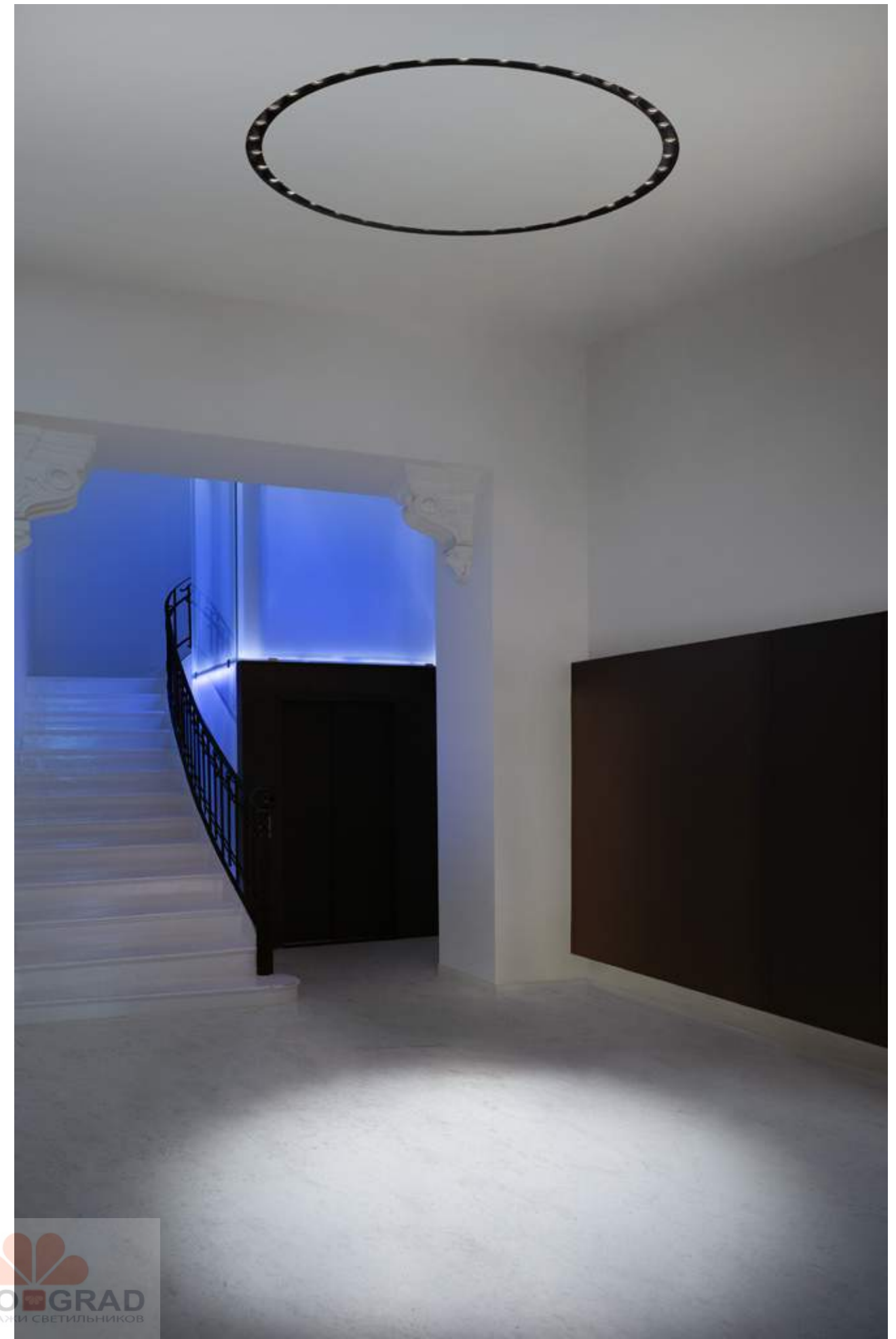

PRIVATE HALL ENTRANCE - SPAIN



Sistema estructural integrado en la arquitectura que permite la instalación tanto de equipos de iluminación directa como de equipos de iluminación indirecta. El sistema Light Cut se puede equipar con proyectores LED de última generación, proyectores halógenos o proyectores de halogenuro metálico. La iluminación ambiental está disponible en fluorescencia, en LED y en LED RGB.

LIGHT CUT

A structural system integrated into the architecture, which permits mounting direct and indirect lighting gear. The Light Cut system can be equipped with latest generation LED spotlights, halogen spotlights or metal halide spotlights. The ambient lighting is available in fluorescent, LED and in RGB LED lamps.





LIGHT CUT

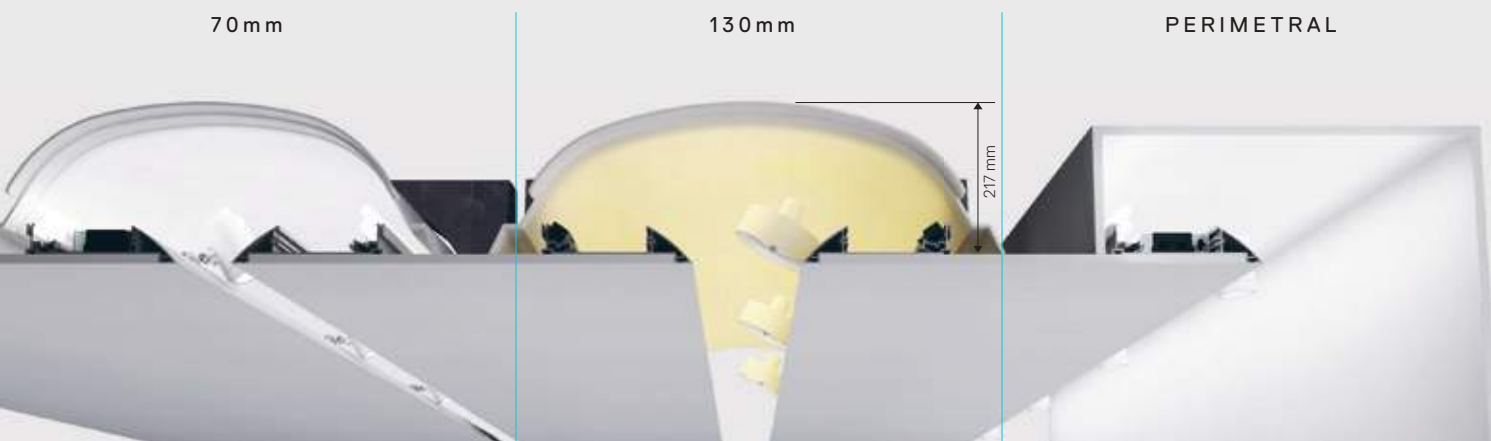

Sistema de iluminación que se compone de un perfil de extrusión que se integra perfectamente en el techo realizado en cartón yeso. Está preparado para integrar de una forma sencilla iluminación con proyectores LED, halógenos o de halogenuro metálico para luz de acento con iluminación ambiental en fluorescencia o LED.

Los proyectores están preparados para ser instalados directamente sobre el perfil, con regletas de conexión rápidas para una fácil conexión entre ellos. Además están disponibles en dos tamaños en función de la instalación. Dispone de accesorios para optimizar el confort visual y filtros de color.

Con este sistema es posible realizar canales perimetrales o instalación central con canales dobles con dos anchos de apertura: 70 mm y 130 mm.

La luz ambiental se puede conseguir mediante fuente de luz fluorescente lineal T5. Estos módulos lineales T5 disponen de un sistema overlapping para evitar sombras y obtener un efecto de luz uniforme.

Para obtener efectos de luz más innovadores se pueden utilizar LEDs en blanco cálido o RGB para la luz ambiente. Los módulos LED se anclan directamente al perfil y son interconectables entre sí de forma que se pueden conseguir tiras continuas que ofrecen una luz uniforme. Estos LEDs pueden ser regulados mediante sistema radio frecuencia, 1-10V, DALI o DMX.

Lighting system comprising an extruded profile which integrates perfectly in a plasterboard ceiling. It is prepared for the simple integration of lighting with LED projectors, halogens or metal halides, accent light with ambient lighting in fluorescence or LED.

The projectors are prepared for installation directly on the profile, with quick connection strips for easy connection between them. Furthermore, they are available in two sizes depending on the installation. It has accessories for visual comfort optimization and colour filters.

Perimeter channels or central installation can be made with this system using double channels with two opening widths: 70 mm and 130 mm.

Ambient light can be achieved with a T5 linear fluorescent light source. These T5 linear modules have an overlapping system to prevent shadows and achieve a uniform light effect.

To achieve more innovative light effects you can use LEDs in warm white or RGB for ambient light. The LED modules are anchored directly to the profile and are interconnectable so continuous strips can be achieved offering a uniform light. These LEDs can be regulated via a radio frequency system, 1-10V, DALI or DMX.

Colores
Colours

30 Blanco Mate
30 Matt White

14 Negro Mate
14 Matt Black

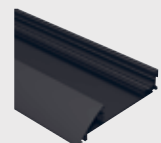
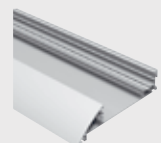

LIGHT CUT



LIGHT CUT

Instalación Canal 70 / Channel 70 Installation

Perfil de Aluminio
Aluminium Profile

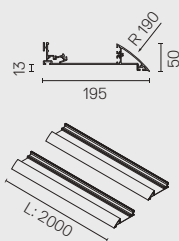

Bóveda de Composite
Composite Housing

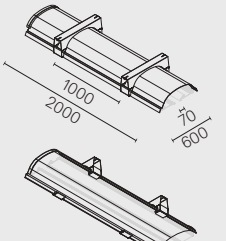

Terminal
Endcap

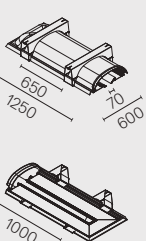

Esquina
Corner

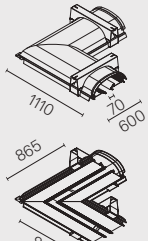

Sistema estructural realizado en aluminio para integrar en techos realizados en cartón yeso. Permite incorporar proyectores y luz ambiental LED o T5. Para la instalación en canal se compone de perfiles de 2 metros, esquinas y terminales. Además es posible incorporar bóvedas realizadas en Soft-composite que encajan en los perfiles para obtener un efecto cove-lighting.

Structural system made out of aluminium to integrate on ceilings made out of gypsum. It allows incorporating projectors and LED ambient or T5 light. For the channel installation it is made up of 2 meters profiles, corners and terminals. It is also possible to incorporate arches made in Soft-composite that fit into the profiles to obtain a cove-lighting effect.

Instalación Canal 130 / Channel 130 Installation

Perfil de Aluminio
Aluminium Profile

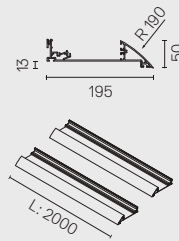

Bóveda de Composite
Composite Housing

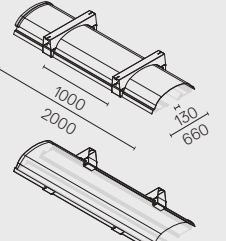

Terminal
Endcap

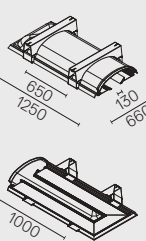

Esquina
Corner

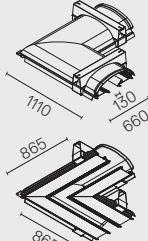

Sistema estructural realizado en aluminio para integrar en techos realizados en cartón yeso. Permite incorporar proyectores y luz ambiental LED o T5. Para la instalación en canal se compone de perfiles de 2 metros, esquinas y terminales. Además es posible incorporar bóvedas realizadas en Soft-composite que encajan en los perfiles para obtener un efecto cove-lighting.

Structural system made out of aluminium to integrate on ceilings made out of gypsum. It allows incorporating projectors and LED ambient or T5 light. For the channel installation it is made up of 2 meters profiles, corners and terminals. It is also possible to incorporate arches made in Soft-composite that fit into the profiles to obtain a cove-lighting effect.

Instalación Perimetral / Perimetral Installation

Perfil de Aluminio
Aluminium Profile

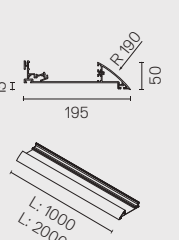

Esquina Interior
Corner Inside

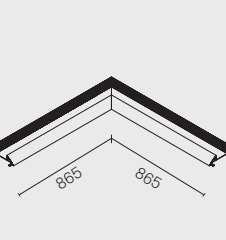

Esquina Exterior
Corner Outside

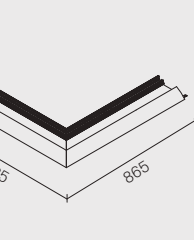

Anclaje a Techo
Ceiling Anchorage

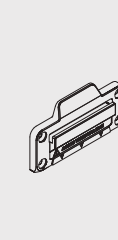

Sistema estructural realizado en aluminio para integrar en techos realizados en cartón yeso. Permite incorporar proyectores y luz ambiental LED o T5. Para la instalación perimetral se compone de perfiles de 1 ó 2 metros, esquinas interiores y exteriores y un accesorio (opcional) de anclaje que facilita la instalación (recomendado 1 por cada 500mm).

Structural system in aluminium to integrate in plasterboard ceilings. It allows incorporation of projectors and LED ambient or T5 lights. Perimeter installation consists of 1 or 2 meters profiles, inside and outside corners, and anchorage accessory (optional) facilitating installation (1 per 500mm recommended).

LIGHT CUT

SPOT MODULE
LED



PHOSPHOR LED
18,2W
1400 lm
3000K/CRI 98
19,2W
1870 lm
3000K/CRI 80



POWER LED
10W
1100 lm
3000K
CRI 80



LED ARRAY
15W
1340 lm
3000K/CRI 80
15W
1140 lm
3000K/CRI 90

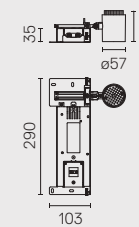
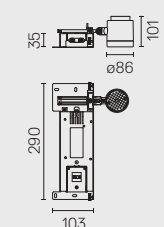

SPOT MODULE
HI PAR 51



HI PAR 51
GX10
20/35W

SPOT MODULE
QR-111



QR-111
G53
MAX 100W
- OR -
LED QR-111

SPOT MODULE
QR-CBC 51



QR-CBC 51
GX5.3
MAX 50W
- OR -
LED QR-CBC 51
7/10W

SPOT MODULE
CDM-R111



CDM-R111
GX8.5
35/70W

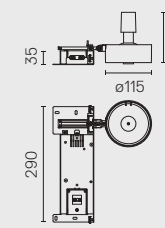
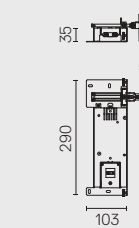
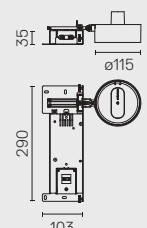
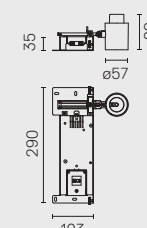

LIGHT CUT

LIGHT CUT



Bóveda bañada con luz retroluminada mediante tecnología LED. Disponible en luz blanca y RGB.

Vault washed with backlighting using LED technology. Available in white light and RGB.



Luz de acento conseguida gracias a los proyectores que se instalan en el perfil mediante regletas de conexión rápidas. Sistema de instalación fácil y sencillo sin necesidad de herramientas específicas.

Accent lighting achieved thanks to the spotlights installed on the profile, using fast connect strips. Easy and simple to install system, that does not require specific tools.



LAWYERS OFFICES - SPAIN

FASHION SHOP - SPAIN



PRIVATE KITCHEN - STATE OF ISRAEL

LIGHT CUT MINI

LIGHT CUT MINI

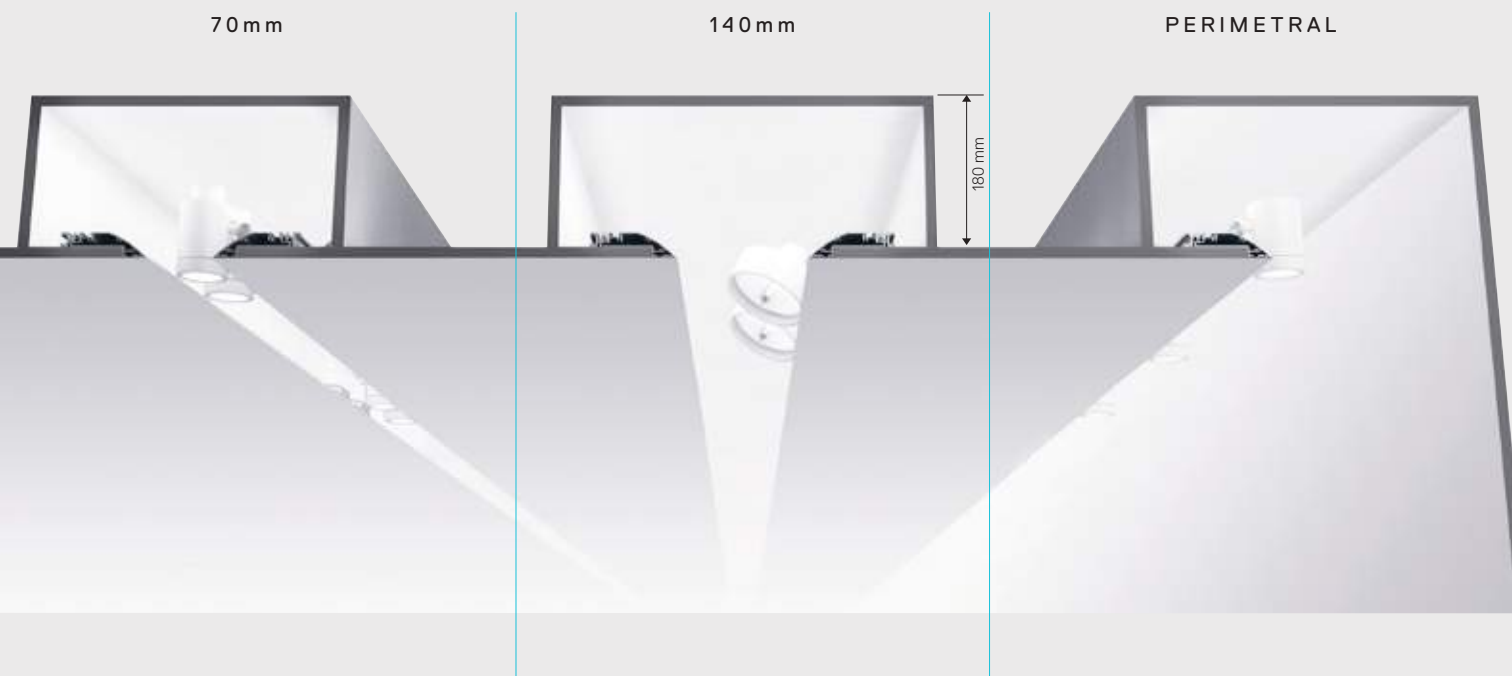

Sistema de iluminación que se compone de un perfil de extrusión que se integra perfectamente en techo realizado en cartón yeso. Está preparado para integrar de una forma sencilla iluminación con proyectores LED, halógenos o de halogenuro metálico para luz de acento. Los proyectores están preparados para ser instalados directamente sobre el perfil, con equipos remotos de clase II. Además están disponibles en dos tamaños en función de la instalación. Dispone de accesorios para optimizar el confort visual y filtros de color.

Lighting system comprising an extruded profile which integrates perfectly in a plasterboard ceiling. It is prepared for the simple integration of lighting with LED projectors, halogens or metal halides, accent light with ambient lighting in fluorescence or LED. The projectors are prepared for installation directly on the profile, with Class II remote equipment. Furthermore, they are available in two sizes depending on the installation. It has accessories for visual comfort optimization and colour filters.

Colores
Colours

30 Blanco Mate
30 Matt White

14 Negro Mate
14 Matt Black



PRIVATE KITCHEN - STATE OF ISRAEL

LIGHT CUT MINI — PROFILES

Instalación Canal 70
Channel 70 Installation

Perfil de Aluminio
Aluminium Profile

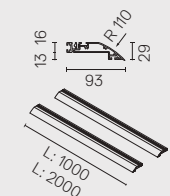

Terminal
Endcap

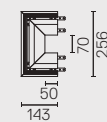

Esquina
Corner

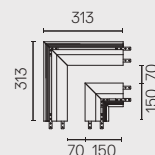

Sistema estructural realizado en aluminio para integrar en techos realizados en cartón yeso. Permite incorporar proyectores. Para la instalación en canal se compone de 1 ó 2 metros, esquinas interiores y exteriores dobles.

Structural system in aluminium to integrate in plasterboard ceilings. It allows incorporation of projectors. Channel installation consists of 1 or 2 meter profiles, double inside and outside corners.

Instalación Canal 140
Channel 140 Installation

Perfil de Aluminio
Aluminium Profile

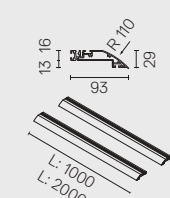

Terminal
Endcap

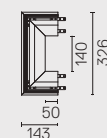

Esquina
Corner

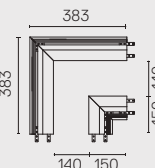

Sistema estructural realizado en aluminio para integrar en techos realizados en cartón yeso. Permite incorporar proyectores. Para la instalación en canal se compone de 1 ó 2 metros, esquinas interiores y exteriores dobles.

Structural system in aluminium to integrate in plasterboard ceilings. It allows incorporation of projectors. Channel installation consists of 1 or 2 meter profiles, double inside and outside corners.

Instalación Perimetral
Perimetral Installation

Perfil de Aluminio
Aluminium Profile

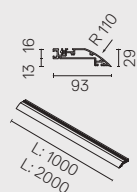

Esquina Interior
Corner Inside



Esquina Exterior
Corner Outside



Accesorio para Esquina Vertical
Accessory for Vertical Corner



Sistema estructural realizado en aluminio para integrar en techos realizados en cartón yeso. Permite incorporar proyectores. Para la instalación perimetral se compone de 1 ó 2 metros, esquinas interiores y exteriores.

Structural system in aluminium to integrate in plasterboard ceilings. It allows incorporation of projectors. Perimetral installation consists of 1 or 2 meter profiles, inside and outside corners.

LIGHT CUT MINI — SPOTS

SPOT MODULE
LED



PHOSPHOR LED
17W
1400 lm
3000K/CRI 98
18W
1870 lm
3000K/CRI 80



LED ARRAY
15W
1340 lm
3000K/CRI 80
15W
1140 lm
3000K/CRI 90



POWER LED
10W
840 lm
3000K
CRI 80

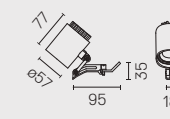
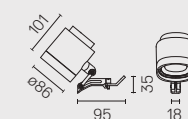

SPOT MODULE
HI PAR 51



HI PAR 51
GX10
MAX 35W

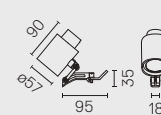

SPOT MODULE
QR-111



QR-111
G53
MAX 100W
- OR -
LED QR-111

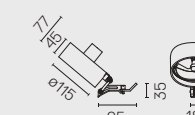

SPOT MODULE
QR-CBC 51



QR-CBC 51
GX5.3
MAX 50W
- OR -
LED QR-CBC 51
7/10W

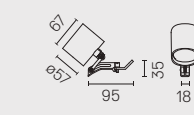

SPOT MODULE
CDM-R111



CDM-R111
GX8.5
MAX 70W

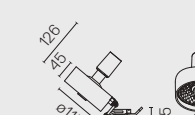

LIGHT CUT MINI



Fácil instalación de los proyectores en el perfil sin necesidad de herramientas específicas.

Este sistema de fijación permite poder tanto cambiar la posición como añadir más proyectores fácilmente.

Easy installation of spotlights on profile without the need for specific tools.

The position of the spotlights can easily be changed or more added with this fixture system.

LIGHT CUT MINI



Familia de aparatos de iluminación directa o indirecta, predispuestos para lámparas fluorescentes lineales, en versión dimable o no dimable. Su diseño nace de la búsqueda del equilibrio entre la fuente luminosa y el espacio arquitectónico circundante.

MINI BEAM

Family of devices for both direct and indirect lighting, ready for linear fluorescent light sources and available in dimmable or non-dimmable versions. Its design emerges from the search for an equilibrium between the light source and the surrounding architectural space.





MINI BEAM



Sistema de iluminación interior con iluminación general fluorescente directa e indirecta. Conexión modular directa sin necesidad de elemento de unión adicional. Cuerpo de la luminaria terminado en pintura polvo. Embellecedores de plástico cromado. Elementos estructurales realizados en acero galvanizado. Sistema de suspensión formado por cables de acero ajustables y conexión eléctrica mediante rosetón con cubierta de policarbonato transparente.

Interior lighting system in general lighting fluorescent accent directly and indirectly. Modular direct connection without the need for additional bonding element. Body of the fitting finished in powder paint. Plastic chrome trim. Structural elements in galvanized steel. Suspension system consisting of adjustable steel cables and wiring through rose covered with transparent polycarbonate.

Colores
Colours

□ 09, 30 Blanco
09, 30 White

■ 20, 02 Gris
20, 02 Grey

■ 30, 14 Negro
30, 14 Black



MINI BEAM

MINI BEAM S1
INDIRECT



MINI BEAM S2
INDIRECT



T5 FH/FQ
G5
2x28W-FH
2x54W-FQ

T5 FH/FQ
G5
2x35W-FH
2x49/80W-FQ

MINI BEAM S1
DIRECT



MINI BEAM S2
DIRECT



T5 FH
G5
2x28W

T5 FH/FQ
G5
2x35W-FH
2x49W-FQ

MINI BEAM
EMERGENCY



POWER LED
1W

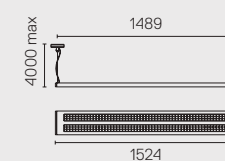
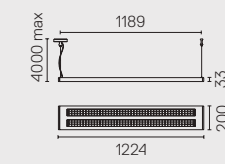
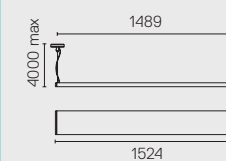
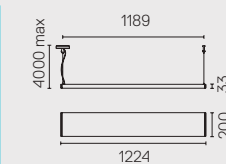

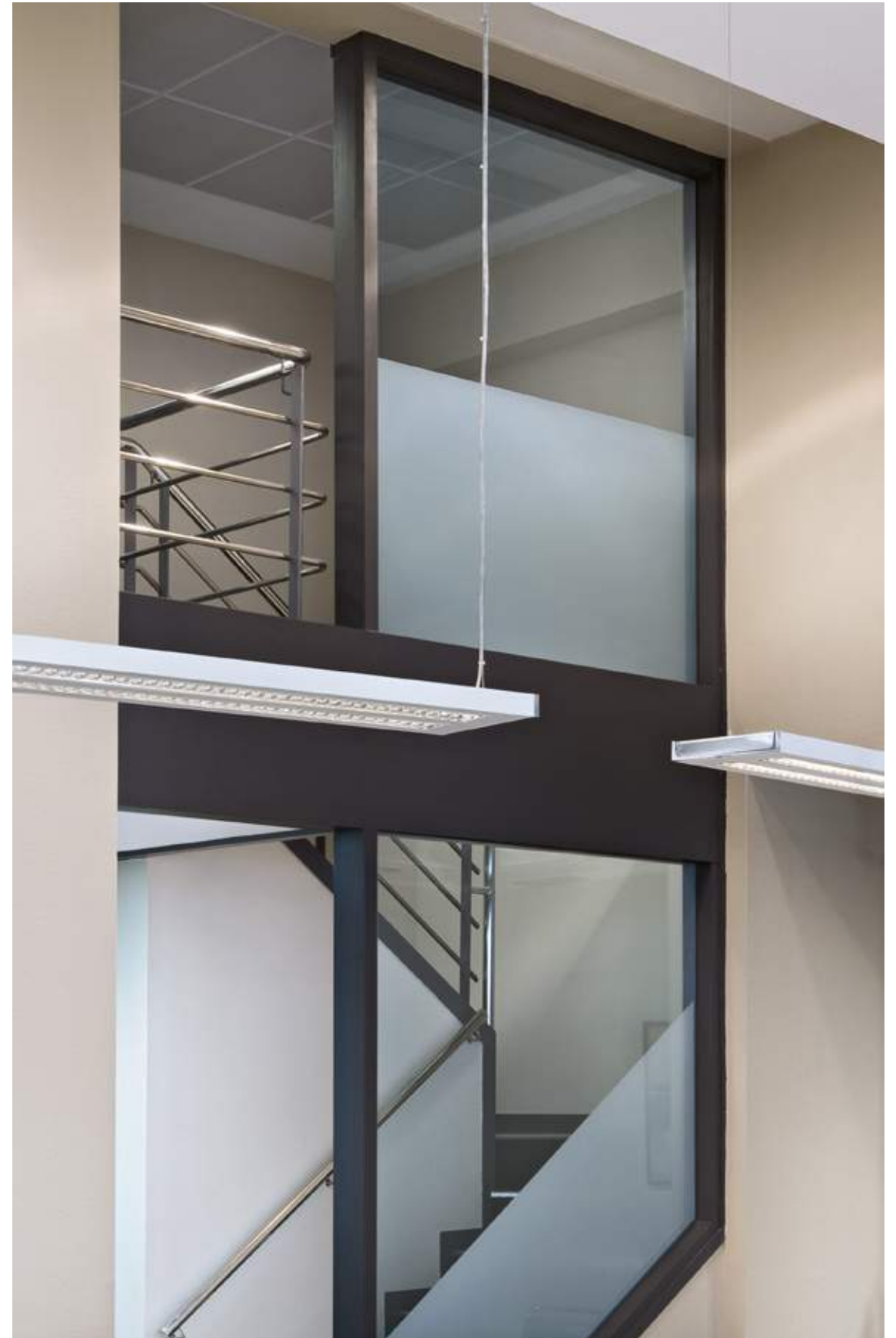

MINI BEAM

MINI BEAM



Disponibile módulo de emergencia con Power LED de 1,2W con temperatura de color de 6500K. Acumulador NiMH. Selección de tiempos de autonomía mediante clavija Jumper.

Availability of an emergency module with 1.2 W Power LEDs and colour temperature of 6500K. NiMH battery charger. Operation time selector through jumper pins.



Perfil de pared para iluminación indirecta. Mínimo y esencial para una perfecta integración en el entorno arquitectónico. De reducidas dimensiones pero con un alto rendimiento luminoso. Un aparato único para una iluminación asimétrica perfectamente uniforme.

THIN LED

Wall-mounted profile for indirect lighting. Essential and minimal for perfect integration into the surrounding architectural space. Thin, but with really high lighting performances. A unique device for even and spotless asymmetrical lighting.





THIN LED

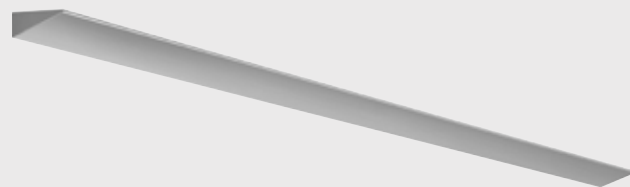

Aparato de iluminación indirecta para ser instalado en la pared.

Cuerpo en aluminio anodizado con reflector interior óptico realizado en aluminio super-puro. Muy fácil de instalar y extremadamente versátil. El circuito impreso está realizado con módulos articulados con un doble conector a través de contactos de plata. Esto asegura un alimentador de corriente seguro evitando daños que podrían originarse durante la fase de montaje.

Los LEDs utilizados con una ajustada frecuencia y una emisión de 120°, junto con el sistema reflector, garantizan unas prestaciones elevadas y una iluminación uniforme.

Gracias a un sistema patentado de control de emisiones de luz, el rendimiento de las lámparas es muy alto, con una distribución de iluminación óptima y muy confortable.

Wall application luminaire for indirect lighting.

Anodized aluminum housing with internal super-pure optical aluminum reflector. Very easy to install and extremely versatile. The printed circuit is made of jointed modules with double connector through silver contacts. This ensure a safe power supply avoiding damages which could be caused during assembling phase.

The utilized LED, with a very tight pitch and a 120° emission, together with the reflection system, grant a very high and even lighting emission performance.

Thanks to a patented light emission control system, the light fitting performance is really high, with an optimized and very comfortable light distribution.

Colores
Colours

30 Blanco
30 White

29 Aluminio Anodizado
29 Anodized Aluminium

BZ Bronce Anodizado
BZ Anodized Aluminium



Modelo patentado y registrado. / Patented and registered Model.

THIN LED

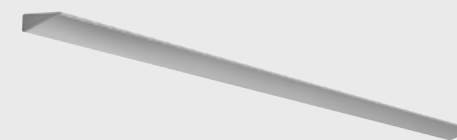

TOP LED
19W/m
24V
1720 lm/m
3000K
CRI 85

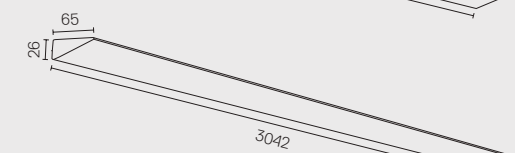
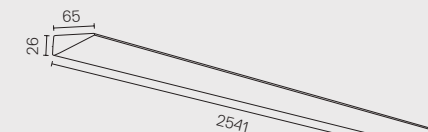
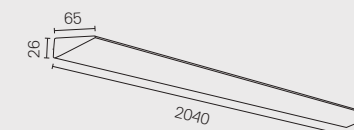
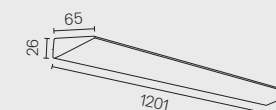
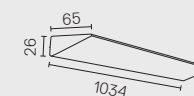
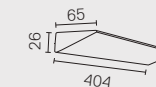

THIN LED



Para su correcta planificación dentro de un proyecto, la luminaria debe ser instalada respetando la relación adecuada entre altura del local y distancia de la misma al techo.

The correct relationship between room height and distance from luminaire to ceiling must be respected when installing the luminaire, for a correct planning within the project.

THIN LED

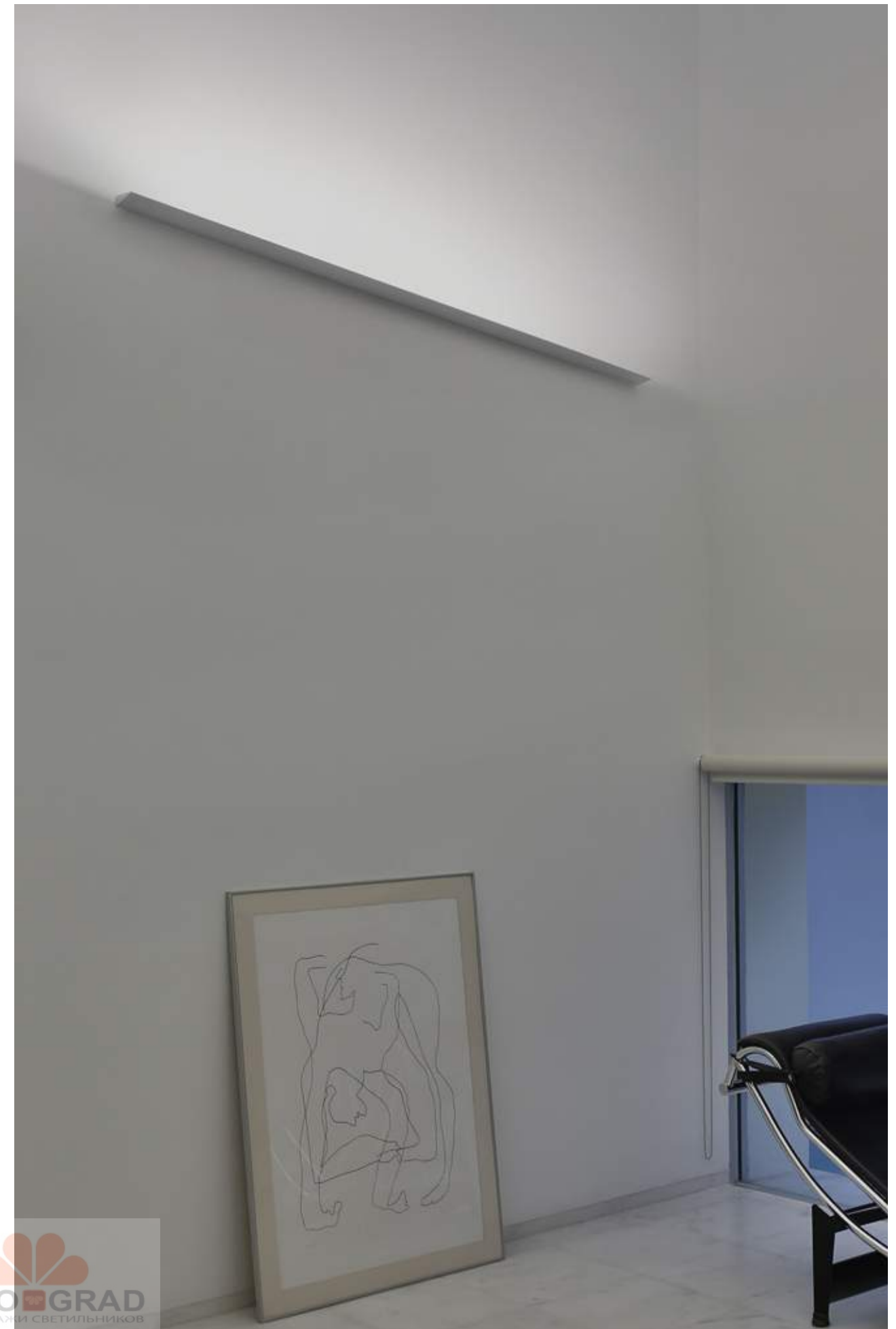

THIN LED

THIN LED

PRIVATE HOUSE - ITALY



84

PRIVATE HOUSE - FRANCE

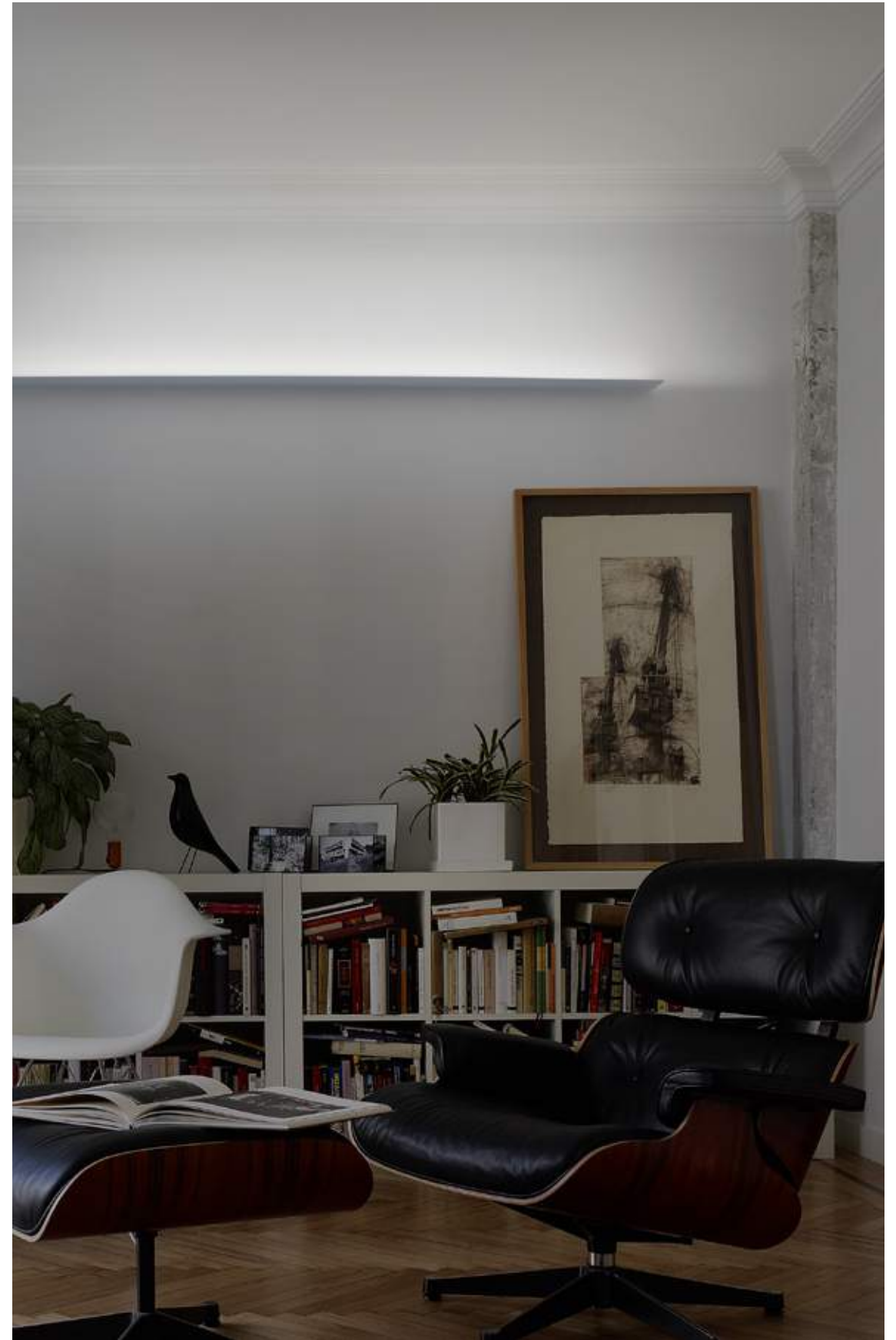

85

Luminaria empotrada equipada con fuente de luz LED. Especialmente diseñada para iluminación wall-washer, la Led Curtain incorpora lentes elípticas para una perfecta distribución luminosa. La familia Led Curtain cuenta con diferentes longitudes interconectables entre sí, haciendo que se adapte fácilmente a distintos espacios, y debido a sus reducidas dimensiones se integra fácilmente en la arquitectura.

LED CURTAIN

Recessed luminaire equipped with LED light source. Especially designed for wall-washer lighting, the Led Curtain incorporates elliptical lenses for perfect light distribution. The Led Curtain family comes in different lengths that can be interconnected, thus easily adapting to different spaces, and due to its small size it integrates easily into the architecture.





LED CURTAIN



Luminaria empotrada con fuente de luz LED. Realizada mediante dos perfiles de aluminio extruido que se emplean como disipador de calor para los LEDs de potencia. Dispone de lentes elípticas para una perfecta distribución luminosa. Disponible en módulos de diferentes longitudes interconectables entre sí mediante un cable de unión con conexión rápida tipo Tyco.

Embedded light fixtures for LED light source. Made of two extruded aluminium sections used to dissipate the heat from the power LEDs. With elliptical lenses for perfect light distribution. Available in modules of different lengths which can be interconnected by a Tyco-type fast-connection cable.

Colores
Colours

30 Blanco
30 White



LED CURTAIN

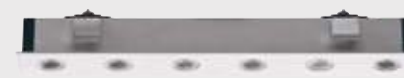

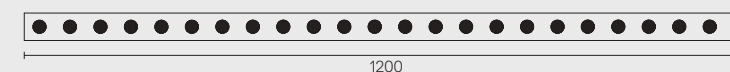

POWER LED
33,5W/m
24V
3440 1m/m
3000K/CRI 82

33,5W/m
24V
3700 1m/m
4000K/CRI 82

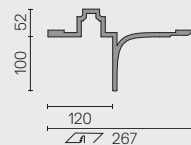

SOFT ARCHITECTURE: LINEAR / SOFT LED CURTAIN

SOFT LED CURTAIN



Perfil modular de tecnología Soft para una instalación a techo, que permite una perfecta integración de la Led Curtain de Flos arquitectural. Sistemas de iluminación no incluidos.

SOFT LED CURTAIN RECESSED

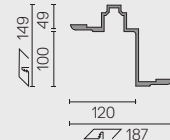

Soft technology ceiling-mounted modular profile, allowing for perfect integration of the Flos architectural Led Curtain. Lighting Systems not included.

LED CURTAIN



Módulos de luz interconectables entre sí mediante cable de unión con conexión rápida tipo Tyco.

Interconnectable light modules using connection cable and Tyco type faston connection.

LED CURTAIN

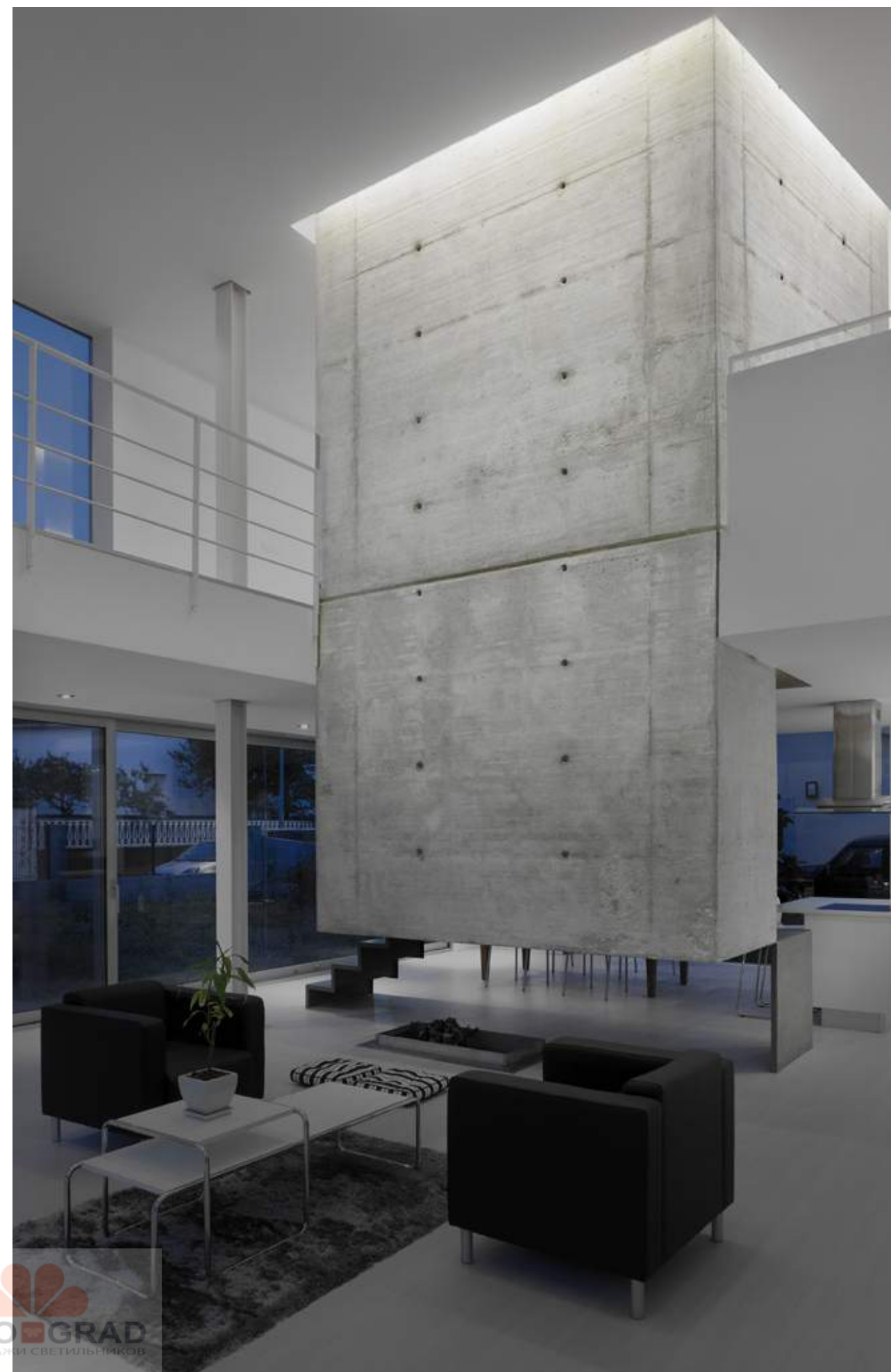

PRIVATE HOUSE - AUSTRALIA



PRIVATE HOUSE - ITALY

Familia para ser instalada en superficie con fuente de luz LED de alto rendimiento. La familia se compone de tiras lineales de LED montadas sobre microperfiles de extrusión de aluminio de diferentes longitudes, conectables entre sí. Estos módulos de luz se combinan con proyectores de luz de acento disponibles en tres ópticas.

LED SQUAD

Surface-mounted family with high performance LED light source. The collection is comprised of linear LED strips mounted on extruded aluminium micro-profiles of different lengths, which can be interconnected. These light modules are combined with accent spotlights available in three optics.

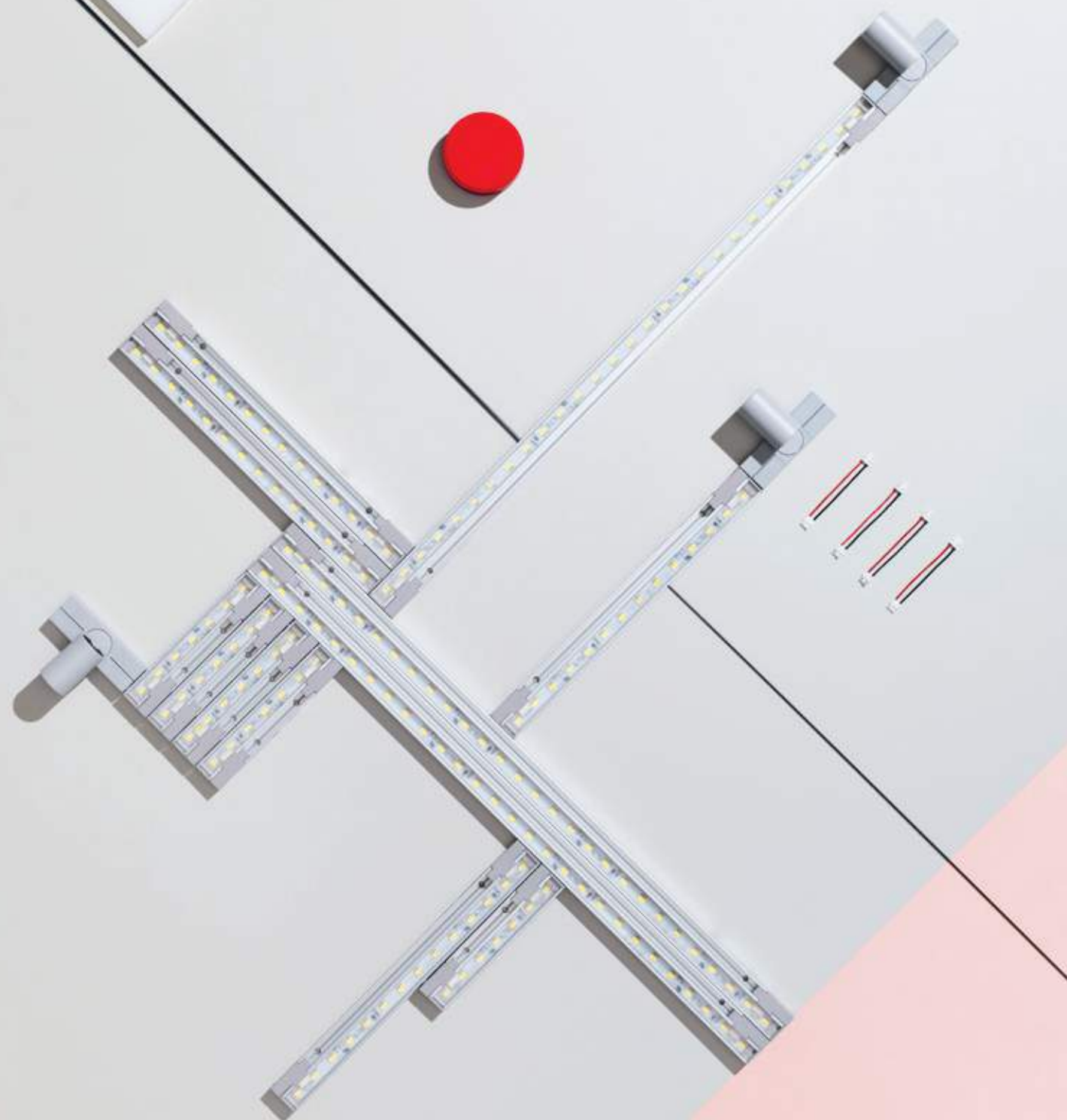



RESTAURANT - SPAIN

LED SQUAD

LED SQUAD



Luminaria para ser instalada en superficie con fuente de luz LED. Realizada mediante perfil de extrusión de aluminio en el que se incorporan módulos de LED lineales. Dispone de difusor opal para obtener una difusión óptima de la luz y conectores rápidos para poder realizar uniones entre módulos de diferentes longitudes. La versión Spot está realizada por un cuerpo óptico de aluminio en el que se incorpora un LED de potencia de alto rendimiento. El control óptico se realiza mediante lentes, con tres ángulos de apertura.

LED SQUAD SPOT



Luminaire to be installed on surface with LED light source. Made out of aluminium extrusion profile in which linear LED modules are incorporated. It has an opal diffuser to obtain perfect light diffusion and quick connectors to be able to make joints between different length modules. The Spot version is made up of an aluminium optical body which includes a high performance power LED. Optical control is made using lenses, with three opening angles.

Colores
Colours

Led Squad

29 Aluminio Anodizado
29 Anodized Aluminium



AN Negro Anodizado
AN Anodized Black



Led Squad 1 Spot

30 Blanco
30 White



02 Gris
02 Grey



14 Negro
14 Black



Led Squad 2 Spots



LED SQUAD

LED SQUAD



TOP LED
24W/m
24V
2307 1m/m
3000K
CRI 80

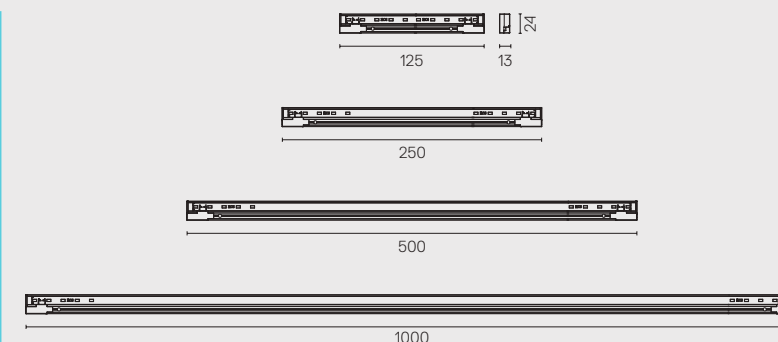

LED SQUAD 1 SPOT



POWER LED
4W
24V
187 1m
3000K
CRI 80

LED SQUAD 2 SPOTS



POWER LED
6W
24V
2x187 1m
3000K
CRI 80

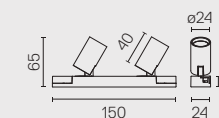
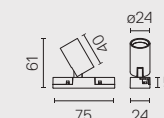

LED SQUAD



Especialmente recomendado para instalaciones en mobiliario comercial / residencial.

Especially recommended for installations in retail / residential fittings.

LED SQUAD





COCKTAIL BAR - SPAIN

Luminaria suspendida de iluminación general para ser instalada en interiores. Cuenta con una fuente de luz LED de última generación de alta eficiencia y difusor realizado en termoplástico técnico de bajas pérdidas. El reflector de la luminaria está realizado en aluminio repulsado, disponible en distintos decorados tanto interiores como exteriores y cristal transparente.

LIGHT BELL

Suspended general lighting luminaire for indoor mounting. It has a high efficiency, latest generation LED light source and a low-loss technical thermoplastic diffuser. The luminaire reflector is made of spun aluminium, available in different patterns inside as well as outside and in transparent glass.





LIGHT BELL





Luminaria suspendida de iluminación general para ser instalada en interiores. Cuenta con una fuente de luz LED de última generación de alta eficiencia y difusor realizado en termoplástico técnico de bajas pérdidas. El difusor de la luminaria se sirve por separado, y está disponible en aluminio repulsado en distintos decorados y en cristal transparente según versiones. Fuente de alimentación integrada en el cuerpo de la luminaria.

Suspended general lighting luminaire for indoor mounting. It has a high efficiency latest generation LED light source and a low-loss technical thermoplastic diffuser. The luminaire diffuser is supplied separately and is available in spun aluminium with different patterns, and in transparent glass, depending on the versions. Power supply source integrated into luminaire housing.

Colores
Colours

Exterior / Outside	<input type="checkbox"/> 70 Blanco Mate 70 Matt White	<input checked="" type="checkbox"/> AP Aluminio Pulido AP Polished Aluminium	<input checked="" type="checkbox"/> AN Negro Anodizado AN Anodized Black
Interior / Inside	<input checked="" type="checkbox"/> Aluminio Anodizado Anodized Aluminium	<input checked="" type="checkbox"/> Aluminio Anodizado Anodized Aluminium	<input checked="" type="checkbox"/> Oro Gold

Exterior / Outside	<input checked="" type="checkbox"/> MM Marrón Oscuro MM Dark Brown	<input checked="" type="checkbox"/> 7C Negro Mate 7C Matt Black
Interior / Inside	<input checked="" type="checkbox"/> Oro Gold	<input checked="" type="checkbox"/> Cobre Galvanizado Galvanic Copper





Exterior / Outside	<input checked="" type="checkbox"/> CU Cobre CU Copper	<input checked="" type="checkbox"/> 76 Cristal Transparente 76 Transparent Glass
Interior / Inside		





LIGHT BELL

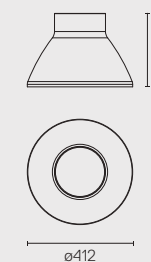
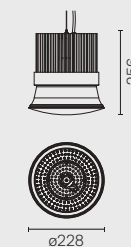

LED ARRAY
46,8W
3220 1m
2700K/CRI 90

55,3W
5880 1m
3000K/CRI 80





SPORTS PAVILION - GERMANY



LIGHT BELL



A Disipador de aluminio de altas prestaciones que garantiza la refrigeración del LED.

B Pantalla intercambiable en distintos acabados.

A High-performance aluminium dissipater that guarantees LED cooling.

B Interchangeable screen in different finishes.

LIGHT BELL







Familia de luminarias de iluminación general (de mínimo impacto gracias a su reducido perfil) con distribución luminosa directa e indirecta. Equipada con fuentes de iluminación LED que suministran un flujo luminoso óptimo y de gran confort visual permitiendo reducir al mínimo las pérdidas de energía. La familia Super Flat está disponible en versión de superficie y en versión suspendida.

SUPER FLAT

Family of general lighting luminaires (minimal visual impact thanks to their reduced profile) with direct and indirect light distribution. Equipped with LED lighting sources that supply an optimal flow of light, great visual comfort and minimising energy losses. The Super Flat family is available in two different versions: surface and suspended.





LIGHT + BUILDING FAIR - SWEDEN

SUPER FLAT

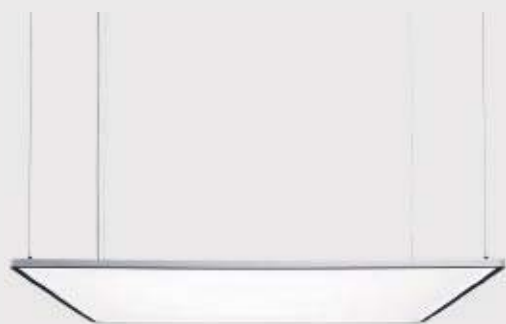

Familia de luminarias de iluminación general con distribución luminosa directa e indirecta. La familia Super Flat consta de varias versiones en forma cuadrada y rectangular, todas ellas realizadas en aluminio extruido y escuadras realizadas en aluminio de inyección.
 El Super Flat cuenta con unas guías especialmente diseñadas asegurando un flujo luminoso óptimo y un gran confort visual. La eficacia de este innovador sistema de iluminación permite reducir al mínimo las pérdidas de energía.
 Para una mayor versatilidad del producto, toda la familia Super Flat se ha desarrollado en versiones suspendida y de superficie.

Family of general lighting luminaires with direct and indirect light distribution. The Super Flat family has several square and rectangular versions, all of which are made of extruded aluminium and with angle brackets made of injected aluminium.
 The Super Flat has some especially designed guides, guaranteeing optimal light flow and great visual comfort. Energy losses are minimised with this efficient and innovative lighting system.
 The entire Super Flat family has been developed in suspended and surface mounted versions for greater product versatility.

Colores
Colours

30 Blanco
30 White

02 Gris
02 Grey

14 Negro
14 Black



Premios
Awards



SUPER FLAT

SUSPENSION DOWN / UP&DOWN

30X30



60X60



90X90



120X20

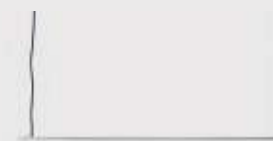

120X30



TOP LED
3000K/CRI 80
4000K/CRI 80

SURFACE

60X60



90X90



120X20

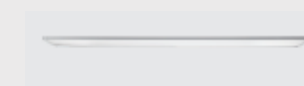

120X30

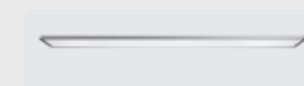

TOP LED
3000K/CRI 80
4000K/CRI 80

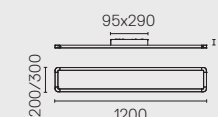
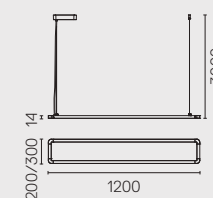
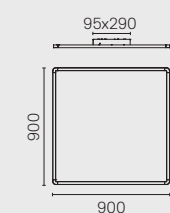
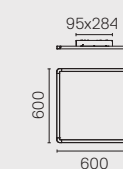
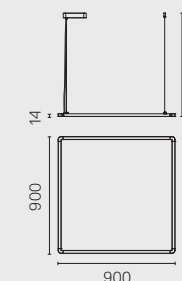
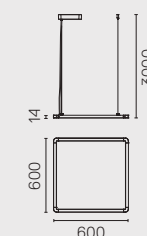

SUPER FLAT



Reducido perfil de aluminio que minimiza el impacto visual.

Reduced size aluminium profile minimising visual impact.

SUPER FLAT





Luminaria circular de luz general para empotrar en techo con tipo de instalación No-Trim. Está disponible en fuente de luz fluorescente con una distribución de la luz sin sombras. Dispone de un marco de instalación de aluminio y un difusor opal realizado con tecnología de rotomoldeo que ofrece una luz muy confortable. Está disponible en dos diámetros y en versiones No Dimable, Dimable y Dimable Dali. También está disponible la versión de emergencia, permitiendo que la luminaria permanezca encendida en el caso de que el suministro de energía falle.

SUN

Ceiling-mounted circular luminaire, offering general light, with a no-trim aluminium recessed mounting, and opal diffuser. Manufactured using rotary moulding technology the fluorescent light sources are shadow-free allowing for a very comfortable light distribution. It is available in two diameters and Non-Dimmable, Dimmable and Dali Dimmable versions. It is also available in emergency version, meaning that the luminaire remains on if there is a power supply interruption.



DESIGNED BY ANTONIO CITTERIO





PRIVATE OFFICES - SPAIN

SUN

SUN 400mm



SUN 700mm



Luminaria empotrada de interiores de fácil instalación sobre techos de cartón yeso formada por una estructura circular sobre la que van posicionados módulos de iluminación directa de fluorescencia.

La geometría del difusor de la luminaria permite la total adaptación e integración del Sun a la superficie del techo de cartón yeso. Asimismo el sistema de iluminación mediante fluorescencia permite una iluminación confortable y sin sombras.

El Sun está disponible en diámetro de 400mm y diámetro de 700mm.

Recessed luminaire for indoor use, easy to mount on plasterboard ceilings, comprised of a circular structure which houses the direct fluorescent lighting modules.

The geometry of the luminaire diffuser permits total adaptation and integration of the Sun to the surface of the plasterboard ceiling. Likewise, the fluorescent lighting system permits comfortable shadow-free lighting.

The Sun is available in 400mm and 700mm diameter.

Colores
Colours

40 Blanco
40 White



SUN

SUN
400mm



TL5-C
1x22W
1x40W

SUN
700mm



T5-FH
4xT5 14W +
2xTC-L 16W



T5-FQ
4xT5 24W +
2xTC-L 24W

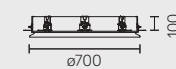
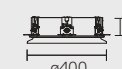

SUN

SUN

PRIVATE HALL - FRANCE



136

HOTEL ENTRANCE - SPAIN



137

SUN



Difusor de polietileno obtenido por roto-
moldeo.

Polyethylene diffuser obtained by rotary
moulding.

SUN



HAKAI STORE - SPAIN

La colección consta de aparatos de iluminación directa para instalaciones en el techo. Disponible con lámparas de halogenuros metálicos, halógenas a baja tensión Qr-111 para un haz de luz acentuado y en LED de última generación. La versión PRO prevé también la variante para suspensión.

TUBULAR BELLS

The collection is comprised of direct lighting ceiling-mounted devices. Available with metal halide and halogen lamps at low voltage Qr-111 for accented light beam and in latest generation LED. The PRO version also includes a variant for suspension.



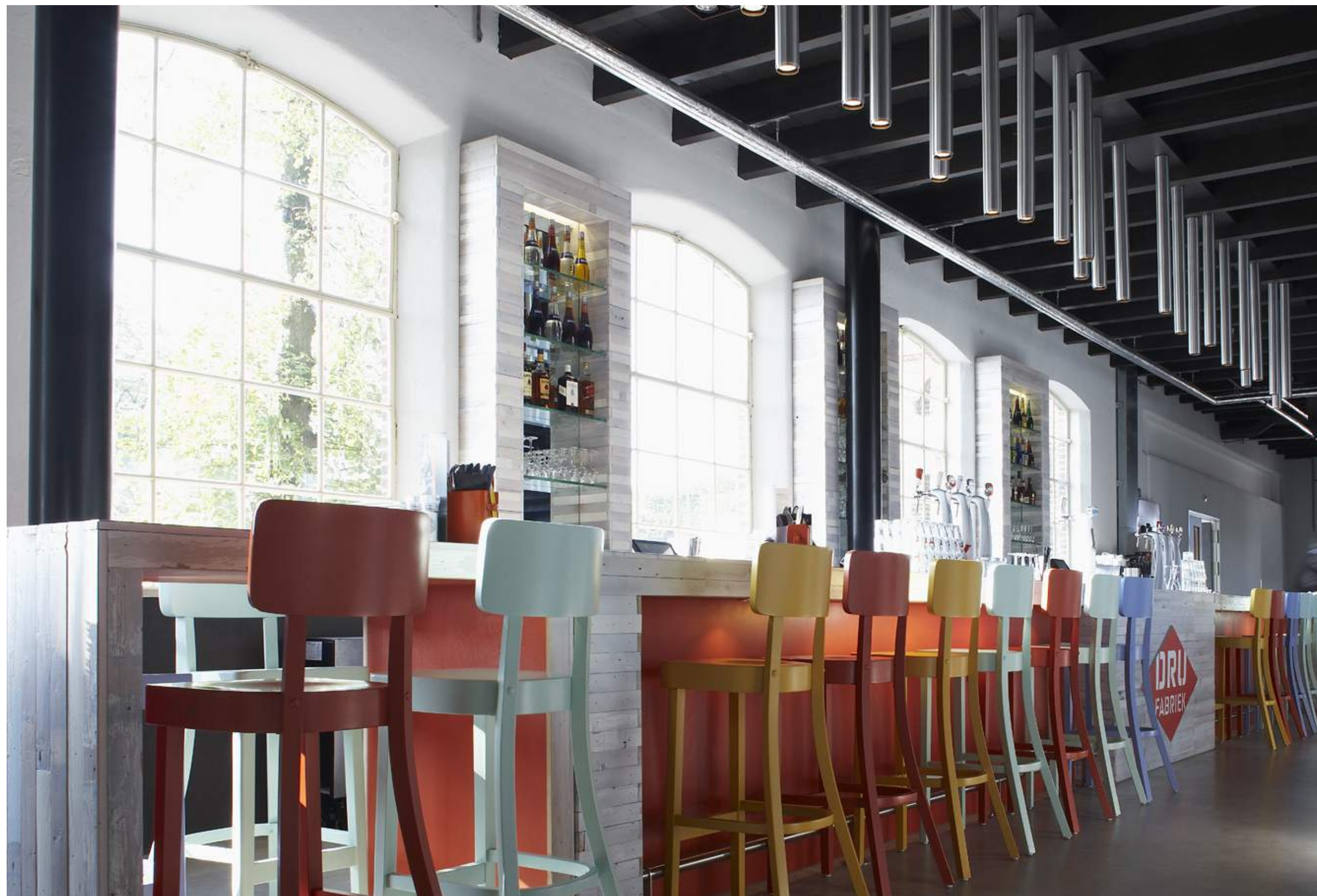

DRU CULTUURFABRIEK - THE NETHERLANDS

TUBULAR BELLS



Luminarias de techo para iluminación directa. Cuerpo de la luminaria realizado en aluminio extruido. Disponen de zoom para regular el grado de abertura del haz luminoso.

Las versiones 1/2 están disponibles en dos longitudes diferentes: 100 y 550mm.

Ceiling luminaires for direct illumination. Body of the luminaire made of extrusion aluminium. Zoom lens available to regulate the opening grade of luminous beam.

Versions 1/2 are available in two different lengths: 100 and 550mm.

Colores
Colours

09 Blanco
09 White

61 Aluminio Satinado
61 Brushed Aluminium

30 Negro Anodizado
30 Anodized Black



TUBULAR BELLS

TUBULAR BELLS 1
CEILING



QT-14
G9
MAX 40W

TUBULAR BELLS 2
CEILING



QT-14
G9
MAX 40W



QT-12
GY6.35
MAX 50W



TUBULAR BELLS

TUBULAR BELLS

VIRGIN ACTIVE - PORTUGAL



146

PRIVATE OFFICES - SWITZERLAND

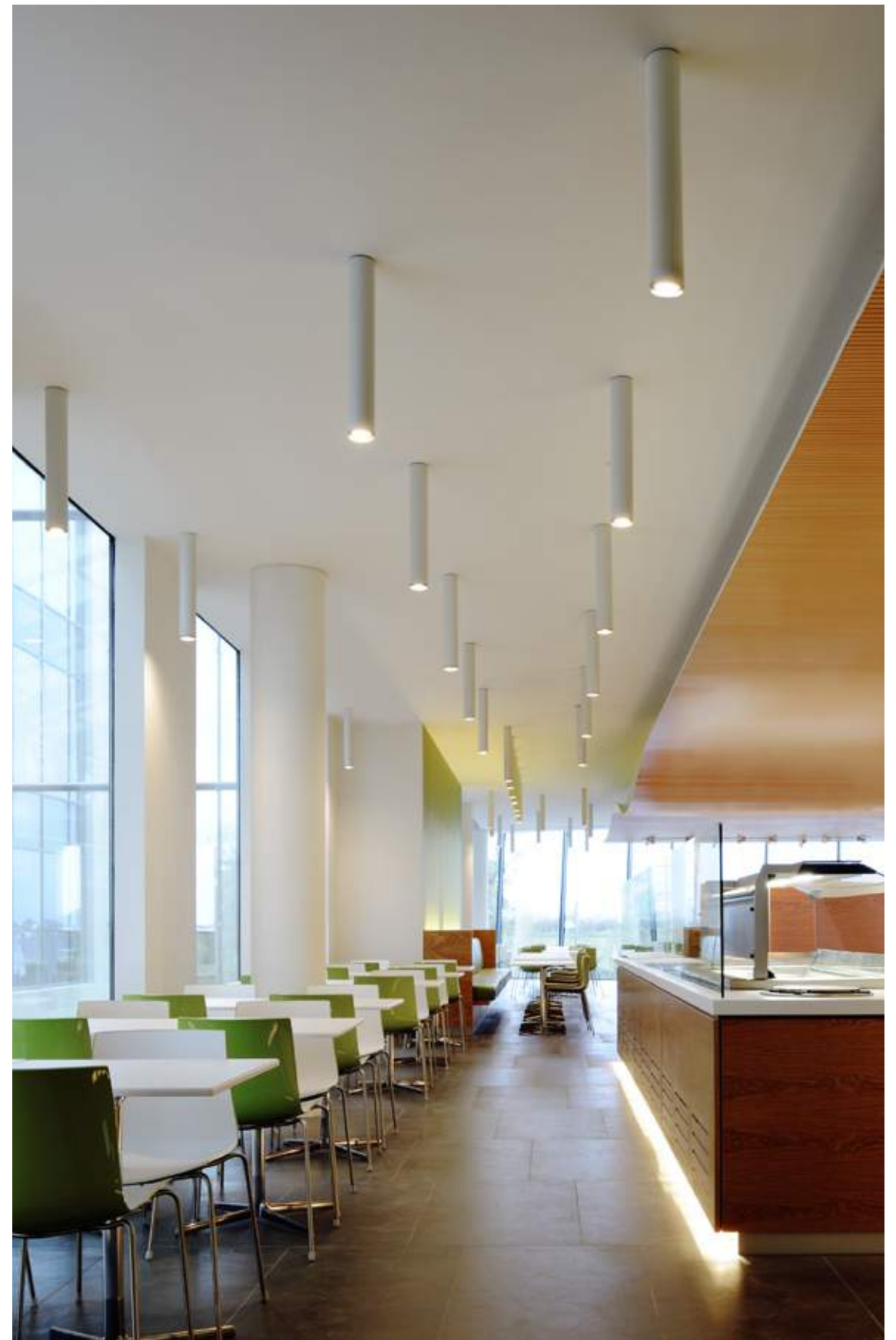

147

TUBULAR BELLS PRO



Luminarias de techo para iluminación directa. Cuerpo de la luminaria realizado en aluminio extruido. Disponen de zoom para regular el grado de apertura del haz luminoso. La versión LED y las versiones PRO disponen de cruceta apantalladora.

Ceiling luminaires for direct illumination. Body of the luminaire made of extrusion aluminium. Zoom lens available to regulate the opening grade of luminous beam. The LED version and the PRO versions have a crosshead shielded.

Colores
Colours

09 Blanco
09 White



61 Aluminio Satinado
61 Brushed Aluminium



30 Negro Anodizado
30 Anodized Black



TUBULAR BELLS PRO

CEILING



CEILING



SUSPENSION



WALL



PHOSPHOR
LED
8,3W
720 lm
3000K
CRI 80

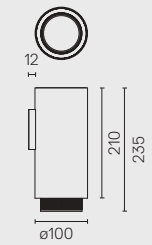
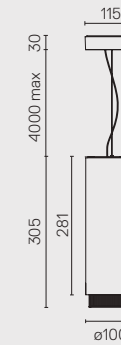
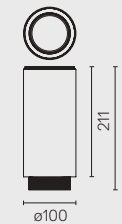



El cuerpo principal de la luminaria incluye un cilindro de apantallamiento regulable con el fin de limitar el deslumbramiento del cuerpo óptico.

The main body of the luminaire is provided with an adjustable cylindrical screen that reduces the glaring effect of the optical body.



Con el fin de regular la perfecta verticalidad de la luminaria durante las operaciones de instalación, la luminaria prevé un sistema de fijación del cable de suspensión regulable.

The luminaire is provided with an adjustable fastener for the suspension line that allows a perfect installation on the vertical axis.



Accesorio para instalación suspendida.

Suspended installation accessory.

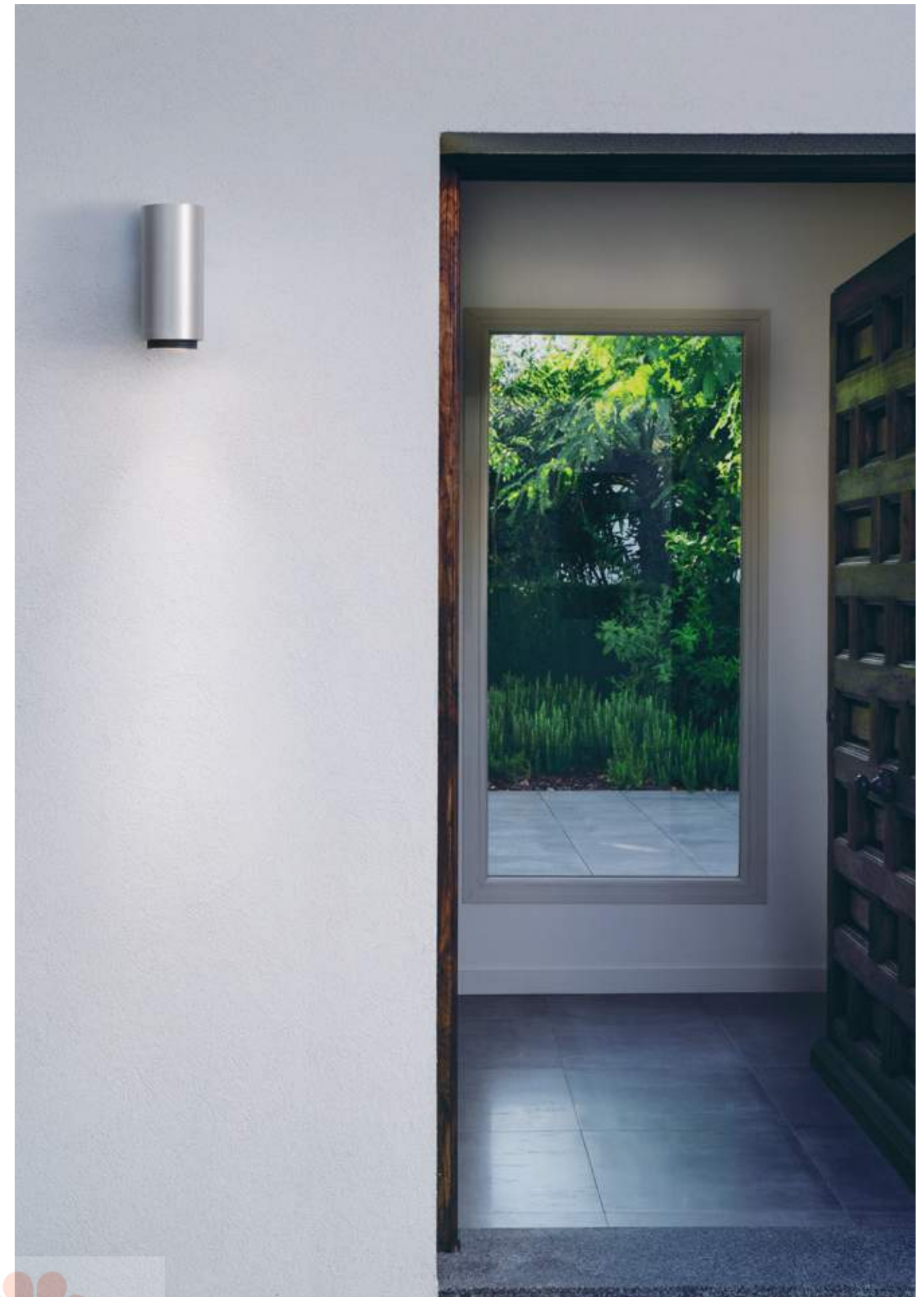

DANIELA HOTEL - ITALY



152

PRIVATE RESIDENCE - SPAIN



153



PANTELLERIA AIRPORT - ITALY

Familia de aparatos de iluminación para instalaciones en pared. LED de pequeñas dimensiones. A una única caja estándar para empotrar que contiene los componentes electrónicos de la lámpara, se puede acoplar fácilmente cualquier aparato de la serie, todos son de reducidas dimensiones.

WALL SYSTEM

Range of small, LED lighting devices designed for wall mounting. Any of the fittings in the range can be coupled, all being extremely small in size, with the single recessed standard casing containing the lamp's electronics.





WALL SYSTEM

BACK



Familia de aparatos de iluminación para su instalación a pared y de luz indirecta (Wall System Back) y directa con doble haz de luz (Wall System Up & Down).

Wall System Back y Wall System Up & Down: cuerpo de aluminio fundido a presión con acabado cromado, sujeción a pared de PC estampado por inyección. El difusor es de metacrilato fotograbado internamente y estampado por inyección.

Para los modelos Back y Up & Down hay dos versiones disponibles: empotrado con controlador integrado, que está equipado con embellecedor de pared redondo (ø125), color aluminio, blanco o negro, o empotrado con controlador remoto, a ras de la pared sin embellecedor. La versión con controlador integrado utiliza indistintamente como encofrado las cajas para pared de mampostería o de pladur, que pueden encontrarse fácilmente en todos los mercados europeos.

En el caso del mercado americano, se prevé su colocación en una "J-box" estándar.

UP & DOWN



Range of indirect-illumination (Wall System Back), dual-emission and direct-illumination (Wall System Up & Down) wall-mounted lighting devices.

Wall System Back and Wall System Up & Down: body in die-cast aluminium with chrome finish, wall attachment in injection-stamped PC. The diffuser is in injection-stamped, internally photo-etched methacrylate.

For the Back and Up & Down models two versions are available: recessed with integrated driver, which takes round wall ornamentals (ø125) in aluminium, white or black colour, or recessed with remote driver, flush with wall without ornamental. The version with integrated driver uses as casing either masonry boxes or plaster board, widely available all over Europe.

For the US market, housing in the standard J-box is envisaged.

Colores
Colours

57 Cromo
57 Chrome



Rotación
Rotation Features

Puede ser orientado 120° y rotado 360°.
Can be swivelled 120° and rotated 360°.

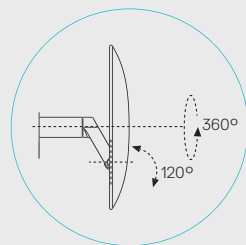

WALL SYSTEM

BACK 1

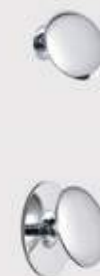

TOP LED
6W
426 1m
3000K
CRI 80

BACK 1
OPTICAL
SWITCH

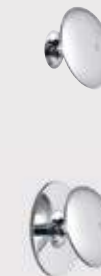

BACK 2



TOP LED
8W
553 1m
3000K
CRI 80

UP & DOWN



POWER LED
4W
2X150 1m
3000K
CRI 82

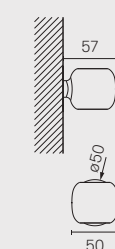

COCKTAIL BAR - SPAIN



162

DETAIL



163

WALL SYSTEM FLEX

MINIKELVIN WALL FLEX



Familia de aparatos de iluminación para su instalación a pared y de luz difusa (Wall System Minikelvin Flex y Minikelvin Wall Flex).

Wall System Minikelvin Flex: cabeza de aluminio fundido a presión, acabado cromado o pintado (blanco/negro). Va montada sobre un tubo flexible, difusor en metacrilato fotograbado externamente con moldura aluminizada.

Para el modelo Minikelvin Flex, hay dos versiones disponibles: empotrado con controlador integrado, que está equipado con embellecedor de pared redondo (ø125), color aluminio, blanco o negro, o empotrado con controlador remoto, a ras de la pared sin embellecedor. La versión con controlador integrado utiliza indistintamente como encofrado las cajas para pared de mampostería o de pladur, que pueden encontrarse fácilmente en todos los mercados europeos.

En el caso del mercado americano, se prevé su colocación en una "J-box" estándar.

Minikelvin Wall Flex: cabeza de aluminio fundido a presión cromado o pintado (blanco/negro) montado sobre un tubo flexible, difusor de metacrilato fotograbado externamente con moldura aluminizada. Fijación a pared en PC estampado por inyección.

MINIKELVIN FLEX



Range of diffuse illumination (Wall System Minikelvin Flex and Minikelvin Wall Flex) wall-mounted lighting devices.

Wall System Minikelvin Flex: die-cast head in chrome finish or painted (black/white) mounted on flexible tube, diffuser in methacrylate externally photo-etched with aluminate frame.

For Minikelvin Flex model, two versions are available: recessed with integrated driver, which takes round wall ornamentals (ø125) in aluminium, white or black colour, or recessed with remote driver, flush with wall without ornamental. The version with integrated driver uses as casing either masonry boxes or plaster board, widely available all over Europe.

For the US market, housing in the standard J-box is envisaged.

Minikelvin Wall Flex: die-cast head in chrome finish or painted (black/white) mounted on flexible tube, diffuser in methacrylate externally photo-etched with aluminate frame. Wall attachment in injection-stamped PC.

Colores
Colours

09 Blanco
09 White

57 Cromo
57 Chrome

30 Negro
30 Black



WALL SYSTEM FLEX

MINIKELVIN
WALL FLEX



MINIKELVIN
FLEX



TOP LED
4W
216 lm
3000K
CRI 85

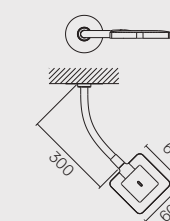
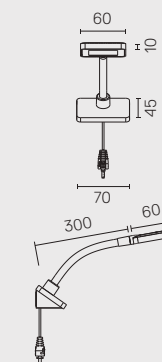

DETAIL



166



PRIVATE HOUSE - SWEDEN

167

Proyector de iluminación interior con fuente de luz LED. Disponible en tres versiones: versión Monopoint, consistente en un cuerpo cilíndrico extraíble que en posición superior hace función de downlight y en su posición inferior se convierte en un proyector orientable, versión Double Point, consistente en una caja empotrada en la que se alojan dos proyectores y versión Suspension.

FIND ME

Interior lighting spotlight with LED light source. Available in three versions: Mono Point version, consisting of a removable cylindrical housing which, in its upper position, acts as a downlight, and in its lower position, becomes a directional spotlight, Double Point version, consisting of a recessed box which houses two spotlights and a Suspension version.





ARCO CAFE - SPAIN

FIND ME

MONO POINT



DOUBLE POINT



Familia de proyectores de interiores con una fácil instalación en techos de cartón yeso, formada por uno o dos módulos de iluminación LED.

La luminaria está disponible en las versiones: Mono Point (Trim, No Trim), Mono Point 2 (No Trim), Double Point y Suspension.

La versión Mono Point se suministra con un marco cilíndrico empotrable sobre el que se instala el módulo de iluminación. Dicho módulo de iluminación puede colocarse en su posición superior, funcionando como un downlight, o en su posición inferior, convirtiéndose en un proyector orientable.

La versión Double Point consiste en un marco de material termoplástico inyectado en la que se instalan dos módulos de iluminación. Al igual que en el modelo Mono Point, los módulos son orientables.

La versión Suspension es una variante de la versión Mono Point. Su principal característica es su instalación mediante suspensión.

Spotlight family for indoor use, easy to mount on plasterboard ceilings, comprised of one or two LED lighting modules.

The luminaire is available in following versions: Mono Point (Trim, No Trim), Mono Point 2 (No Trim), Double Point and Suspension.

The Mono Point version is supplied with a recessed cylindrical frame, which houses the lighting module. This lighting module can be placed in its upper position, when it will work like a downlight, or in its lower position, becoming an adjustable spotlight.

The Double Point version is supplied with an injected thermoplastic material frame, which houses two lighting modules. Like the Mono Point version, the modules are directional and the frame enables the product to be concealed, leaving just the end visible.

The Suspension version is a variant of the Mono Point version. Its main characteristic is its suspended mounting.

Colores
Colours

30 Blanco
30 White

06 Cromo
06 Chrome

14 Negro
14 Black

Mono Point



Double Point

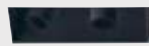

Suspension



Colores del Cilindro Apantallador
Screening Cylinder Colours

Naranja
Orange

Violeta
Violet

Negro
Black



Rotación
Rotation Features

Puede ser rotado 360° y orientado 70°.
Can be rotated 360° and swivelled 70°.

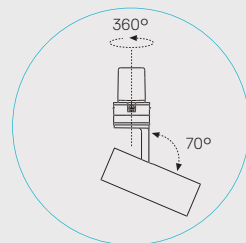

Premios
Awards



reddot design award
winner 2013

FIND ME

FIND ME 1
TRIM / NO TRIM
MONO POINT



FIND ME 1
DOUBLE POINT



FIND ME 1
SUSPENSION



FIND ME 2
NO TRIM
MONO POINT



POWER LED

6W

460 lm

2700K/CRI 90

6W

687 lm

3000K/CRI 80



POWER LED

9W

820 lm

2700K/CRI 90

9W

1100 lm

3000K/CRI 80

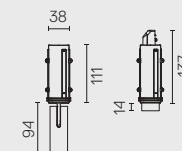
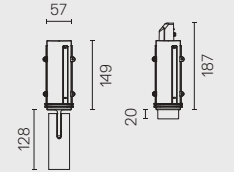
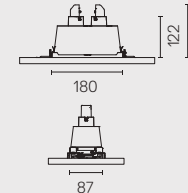
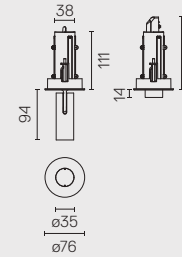

FIND ME

FIND ME



Sistema de desplazamiento mediante pestañas elásticas sobre una guía dentada que permite que los proyectores se escondan, quedando totalmente integrados en el entorno.

An adjustment system with elastic flanges on a toothed guide, permits concealing the spotlights, thus becoming totally integrated into the environment.

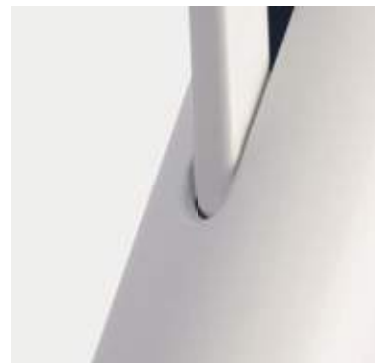

Orientable y basculante gracias a su base con capacidad de rotación de 360° y a su brazo realizado en zamak orientable hasta 70°.

Directional and tilting thanks to its base with 360° rotation capacity and to its arm made of zamak, directional up to 70°.



PRIVATE FLAT - SPAIN

FIND ME

FIND ME

PRIVATE RESIDENCE - U.S.A.



176

PRIVATE LOFT - BRASIL

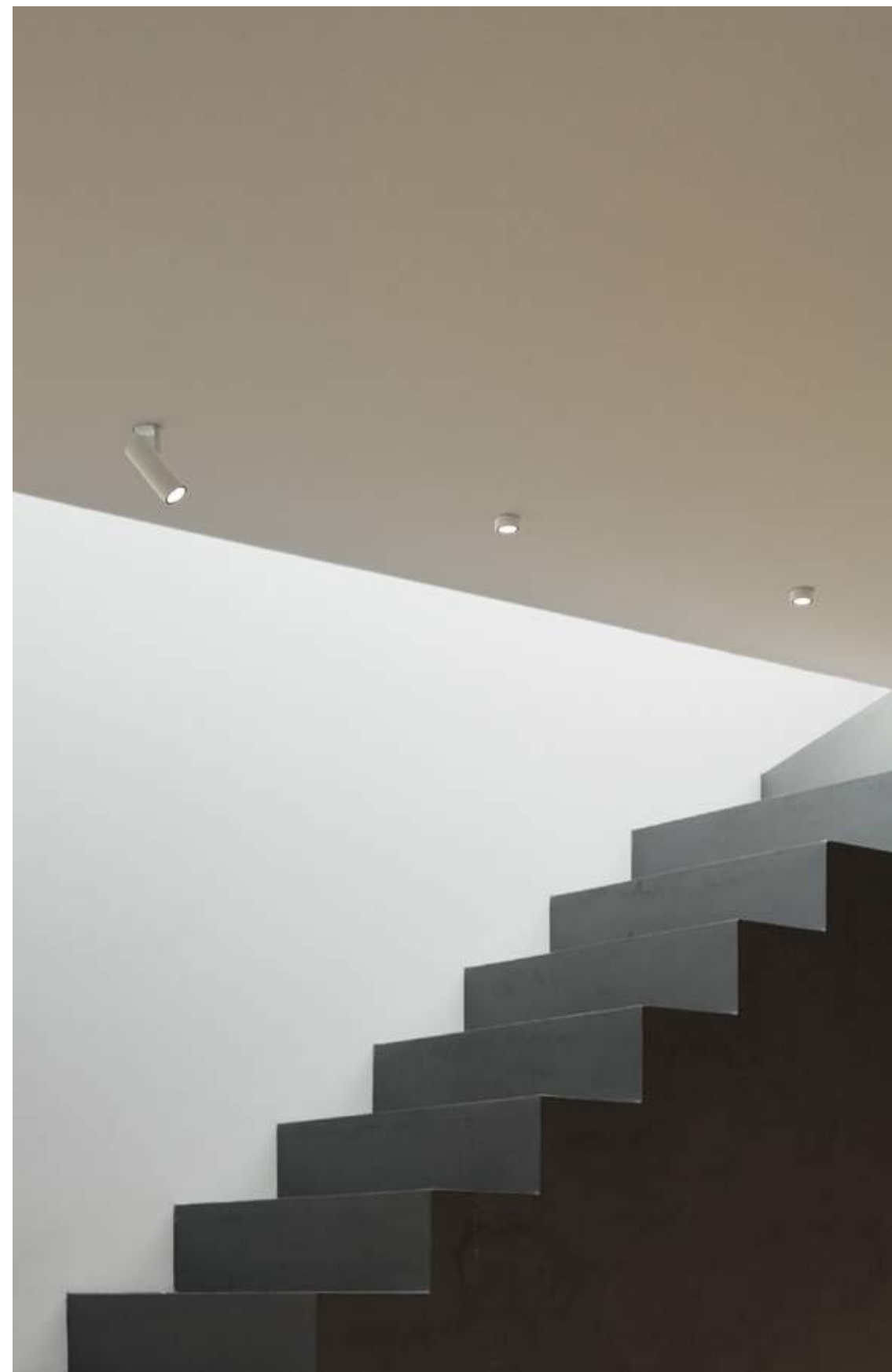

177

Proyector de diseño elegante y finos acabados, pensado para instalaciones a carril o directamente en el techo, en ambiente de uso doméstico o residencial. Lámparas halógenas a muy baja tensión o lámparas de halogenuro metálico.

BELVEDERE

Elegantly designed spotlight with refined finishes, designed for track mounting or direct ceiling mounting, for domestic or residential use. Very low voltage halogen lamps or metal halide lamps.





BELVEDERE



Proyector para ser instalado a techo o a carril trifásico. Para lámparas halógenas de baja tensión y de descarga. Cuerpo realizado en aleación de aluminio inyectado a presión, con acabado pulido a mano, protegidos por pintura líquida transparente o barniz en polvo de color blanco o negro opaco. Adaptador trifásico incluido para la versión a carril. El cilindro de PPS siempre va incorporado.

Luminaire for ceiling or three-phase electric track installation. For very low voltage halogen lamps and discharge lamps. Die cast aluminium alloy body with hand-polished finish and protected with transparent liquid paint, or powder-coated white or matt black. Thermoplastic three-phase adapter. PPS cylinder is always incorporated.

Colores
Colours

30 Blanco
30 White

05 Aluminio Pulido
05 Polished Aluminium

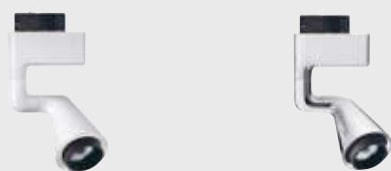

Rotación
Rotation Features

Puede ser orientado 100° y rotado 360°.
Can be swivelled 100° and rotated 360°.

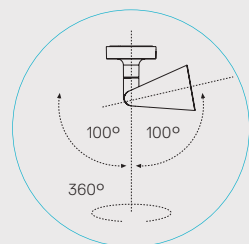

BELVEDERE

BELVEDERE



PAR 16
GZ10
MAX 50W
- OR -
LED PAR 16
4W

BELVEDERE
RECESSED



PAR 16
GZ10
MAX 50W
- OR -
LED PAR 16
4W

BELVEDERE



QR-CBC 51
GX5.3
MAX 50W
- OR -
LED QR-CBC 51
7/10W

BELVEDERE



HI PAR 51
GX10
20/35W

BELVEDERE
12V TRACK



QR-CBC 51
GX5.3
MAX 50W
- OR -
LED QR-CBC 51
7/10W

QR-CBC 51
GX5.3
MAX 50W
- OR -
LED QR-CBC 51
7/10W

HI PAR 51
GX10
MAX 35W

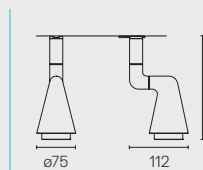
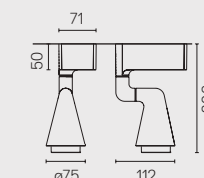
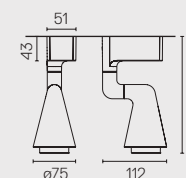
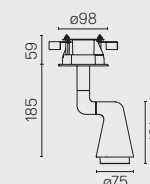
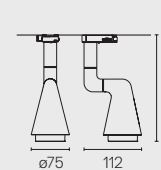



El haz de luz se puede orientar tanto en el plano vertical (180°) como en el horizontal (360°) gracias a un sistema de rotación integrado en la unión del cuerpo óptico y el contenedor de los equipos de control de la lámpara.

Thanks to the rotation system integrated between the optical body and the housing of the control device, the light can be adjusted both vertically (180°) and horizontally (360°).

Fácil mantenimiento de la lámpara sin necesidad de herramientas gracias a su montaje en bayoneta.

The bayonet-based assembly allows to replace the lamp without using any particular tools.



Familia de aparatos de iluminación de gran rendimiento lumínico. Destaca por sus finos acabados y elegante diseño. Los alimentadores de las fuentes luminosas están integrados en el aparato y se encuentran posicionados en el cuerpo principal. Disponibles en las versiones: de carril, de techo y de pared (luz indirecta asimétrica).

FORT KNOX

Family of lighting devices with a high luminous performance that stands out for its fine finishes and elegant design. The light power supply sources are integrated into the device and are positioned in the main housing. Available in versions: track, ceiling and wall (asymmetric indirect light).

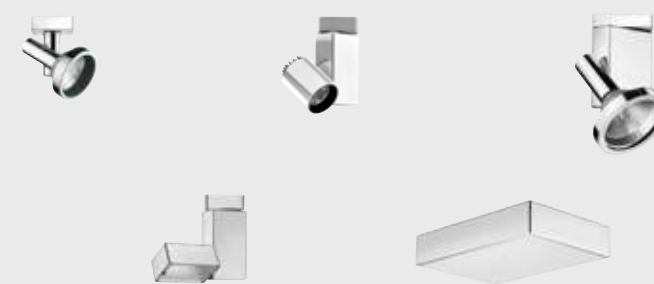



ASPESI STORE - ITALY

FORT KNOX



Proyector para ser instalado a techo o a carril trifásico. Para lámparas LED, halógenas de baja tensión, directas a red y de descarga. Portalámparas cerámico o de tecnopolímero autoextinguible, con cables eléctricos unipolares aislados Teflón con doble aislamiento transparente. Cuerpo para la lámpara constituido por un elemento disipador realizado en aluminio, colocado sobre el portalámparas, por un anillo que sostiene los reflectores realizado en material termoplástico de color negro y por un vidrio templado de 4mm de espesor. El cuerpo, la tapa de cierre y el soporte orientable de la lámpara son de aleación de aluminio inyectado a presión, con acabados pulidos a mano y protegidos por pintura líquida transparente o barniz en polvo de color blanco o negro opaco. Adaptador trifásico incluido para la versión a carril.

Luminaire for ceiling or three-phase electric track installation. For LED lamps, very low voltage halogen lamps, direct mains supply and discharge lamps. Self-extinguishing ceramic or engineering plastic lamp holders, with single-pole, transparent electric wires with double Teflon insulation. Aluminum body, placed above the lamp holder, black thermoplastic and 4mm tempered glass screen-support ring. Die-cast aluminum alloy body, cover and adjustable lamp support, with hand-polished finish and protected with transparent liquid paint, or powder-coated white or matt black. Thermoplastic three-phase adapter.

Colores
Colours

- 09, 30 Blanco
09, 30 White
- 50, 05 Aluminio Pulido
50, 05 Polished Aluminium
- 30, 14 Negro
30, 14 Black



Rotación
Rotation Features

Puede ser orientado 95° y rotado 355°.
Can be swivelled 95° and rotated 355°.

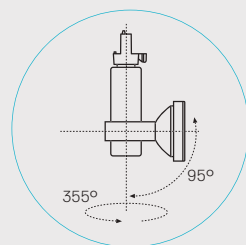

FORT KNOX

FORT KNOX BASIC



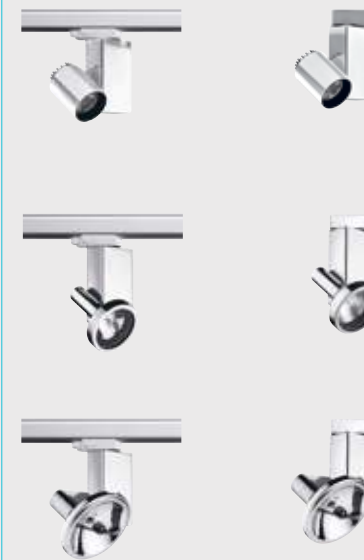

QT-14
G9
MAX 40W

FORT KNOX 1





LED ARRAY
10,5W
930 lm
3000K/CRI 80
15W
1340 lm
3000K/CRI 80

QT-12
GY6.35
MAX 50W

QR-111
G53
MAX 100W
- OR -
LED QR-111

FORT KNOX 1 FLOODLIGHT





QT-12
GY6.35
MAX 50W

FORT KNOX 2

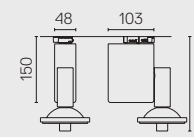
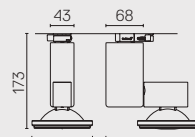
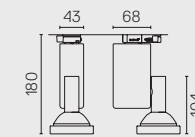
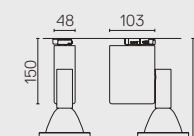
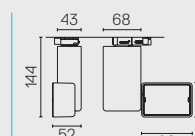
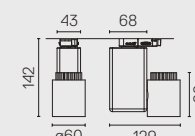
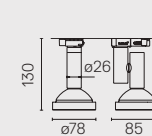

CDM-TC
G8.5
35/70W

CDM-R111
GX8.5
35/70W



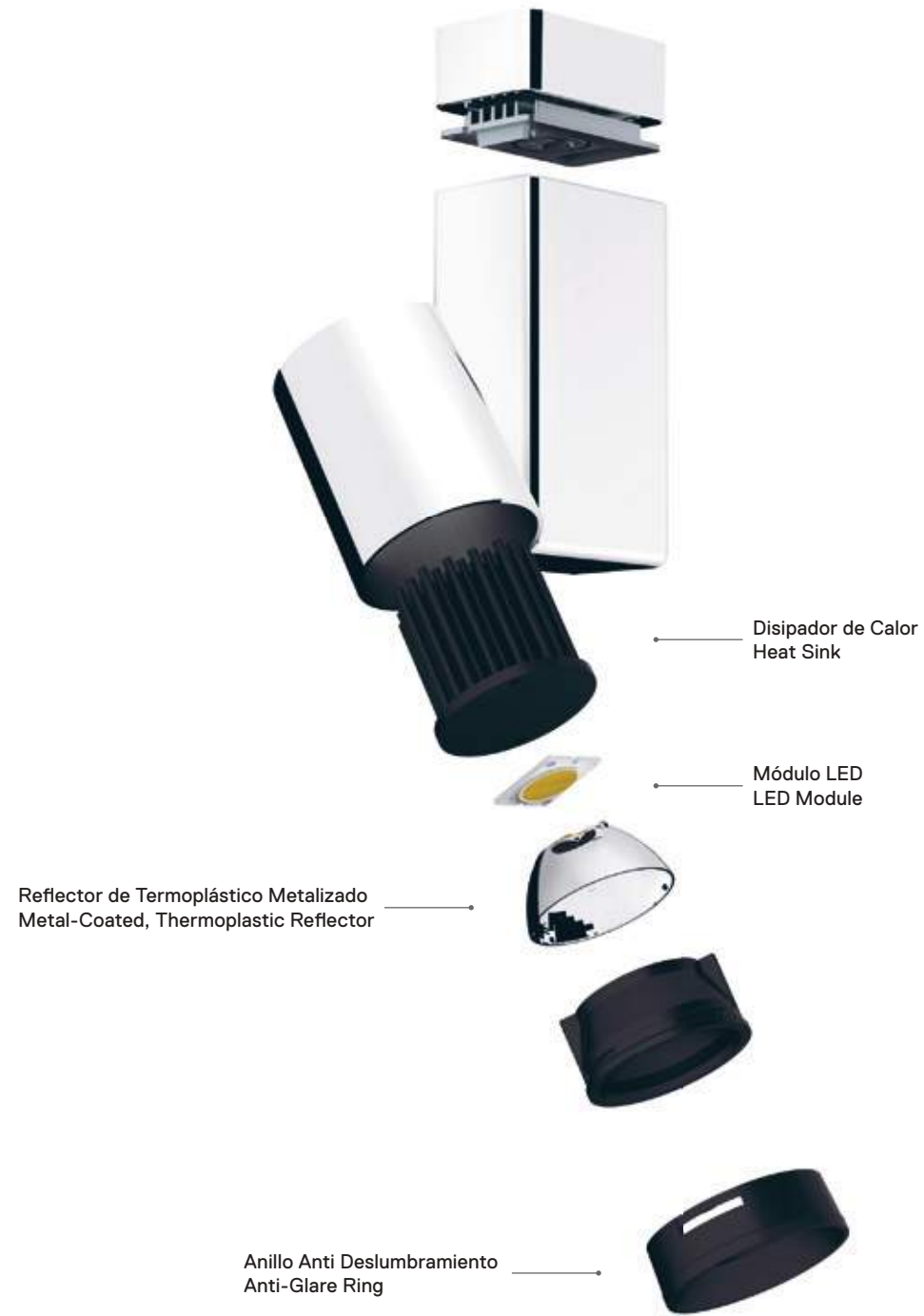



LA OCA STORE - SPAIN



VIRGIN ACTIVE - ITALY

FORT KNOX WALL



Luminaria de pared para luz indirecta. Cuerpo realizado en aleación de aluminio inyectado a presión con acabado pulido a mano y protegido por pintura líquida transparente o barniz en polvo de color blanco o negro mate. Soporte de pared realizado en aluminio inyectado. Permite la regulación tanto en horizontal como en vertical para garantizar la correcta instalación de la luminaria. Incorpora pletina de apantallamiento móvil para poder regular el haz luminoso hacia la pared donde se instala el producto. Cristal templado superior de 3mm de espesor.

Luminary for wall application designed for indirect lighting. Die-cast aluminium alloy body with hand polished finish and protected with transparent liquid paint, or powder-coated white or matt black. Wall support made in injected aluminium. It allows both horizontal and vertical regulation to guarantee the correct installation of the luminaire. It incorporates a mobile lighting plate to regulate the luminous beam towards the wall where the product is installed. 3mm thickness tempered glass.

Colores
Colours

30 Blanco
30 White



05 Aluminio Pulido
05 Polished Aluminium



14 Negro
14 Black

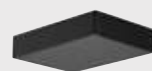

FORT KNOX WALL



HIT-DE-CRI
RX7S
70/150W



QT-DE-12
R7S
MAX 230W IRC

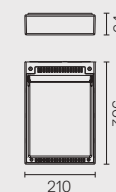



Programa de aparatos de iluminación pensado para instalaciones a techo, a carril (directo a red), o empotrados. Especialmente indicados para iluminación general y de acento. Los aparatos empotrables están disponibles en la versión fija u orientable y en este último caso están dotados de un particular sistema de orientación de tipo “compás”.

COMPASS

Family of lighting devices designed for ceiling, track or recessed mounting. It is especially indicated for general and accent lighting. The recessed devices are available in fixed or directional versions and in this latter case, are equipped with a singular “compass” type directional system.





MONET EXHIBITION - ITALY

COMPASS SPOT



Programa de proyectores de acento y de iluminación general para interiores, con instalación mediante carril trifásico y a pared / techo. Cuerpo óptico realizado en aleación de aluminio inyectado a presión con acabado pintado con barniz en polvo, 118 mm de diámetro, compuesto por un elemento disipador de aluminio, colocado sobre el portalámparas, por un anillo antideslumbramiento realizado en material termoplástico de color negro y por un vidrio de protección templado de 4 mm de espesor. Los dispositivos auxiliares de alimentación están integrados y colocados en un elemento contenedor (vertical u horizontal) realizado en aleación de aluminio inyectado a presión, con acabado pintado con barniz en polvo.

Range of indoor spotlights for accent and general lighting, for three-phase track and wall / ceiling installation. Die-cast aluminum alloy, powder-coated optics compartment, diameter 118 mm, composed of an aluminum dissipating element placed above the lamp support, a black thermoplastic screen support ring and 4 mm tempered glass cover. Integrated auxiliary power units for the lamps inside a die-cast aluminum alloy container (vertical or horizontal) with powder-coated finish.

Colores
Colours

30 Blanco Mate
30 Matt White
 02 Gris
02 Grey
 14 Negro Mate
14 Matt Black



Rotación
Rotation Features

Puede ser orientado 110° y rotado 360°.
Can be swivelled 110° and rotated 360°.

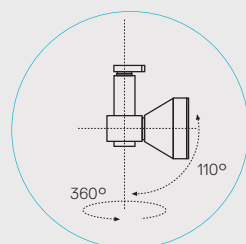

COMPASS SPOT

MAIN SOURCE	VERTICAL GEAR BOX	HORIZONTAL GEAR BOX	FLOODLIGHT WALL-WASHER	FLOODLIGHT/WALL-WASHER VERTICAL GEAR BOX	FLOODLIGHT/WALL-WASHER HORIZONTAL GEAR BOX
PAR 30S E27 MAX 100W	QT-12 GY6.35 MAX 100W	QR-111 G53 MAX 100W - OR - LED QR-111	QT-DE-12 R7S MAX 300W	HIT-DE-CRI RX7S 70W	HIT-DE-CRI RX7S 70W
	HIT-CRI G12 35/70/150W	CDM-TC G8.5 20/35/70W			HIT-CRI G12 150W
		CDM-R111 GX8.5 35/70W			

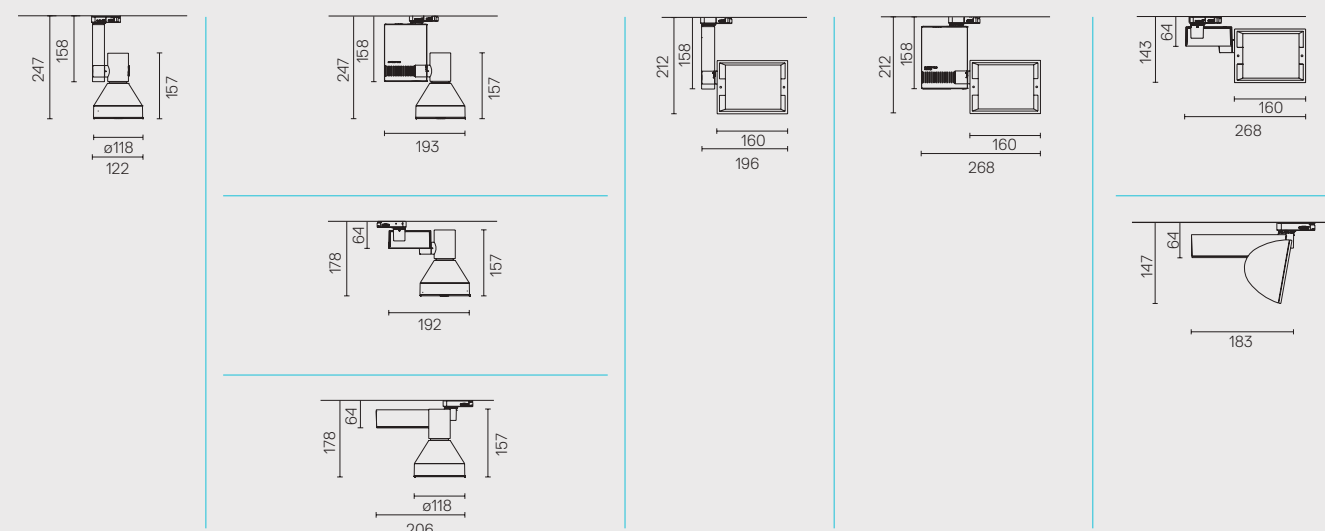

MONET EXHIBITION - ITALY



208

BRITISH MUSIC EXPERIENCE - U.K.



209



Los proyectores para lámparas halógenas de muy baja tensión (12V) incluyen un transformador electrónico que permite regular el flujo luminoso del 10 al 100%.

Spotlights designed for low voltage halogen lamps (12V), incorporating an electronic transformer for 10-100% light adjustment.



El correcto enfoque del haz luminoso en el plano horizontal está garantizado por un goniómetro incorporado en la articulación de rotación.

Correct beam direction adjusted on the horizontal plane by means of a goniometer incorporated in the rotation joint.





O2 ARENA STADIUM - U.K.

COMPASS



Fija: Luminaria para lámparas halógenas o de descarga de alta presión. Cuerpo para empotrar de metal barnizado de color negro. Anillo de cierre en aleación de aluminio inyectado a presión y pintado con barniz en polvo. Portalámparas con elemento disipador en aluminio inyectado a presión. Anillo antirreflejos de material termoplástico negro. Cristal de protección templado de 4 mm de espesor. Sistema de fijación mediante soportes de acero inoxidable.

Fixed: Luminaire for halogen and high-pressure discharge lamps. Recessed body in black-painted metal. Die-cast aluminum alloy, powder-coated closing ring. Die-cast aluminum lamp support with heat dissipating element. Black thermoplastic anti-glare ring, 4mm tempered glass cover. Stainless steel fixing brackets.

Orientable: Luminaria para lámparas halógenas o de descarga de alta presión. Cuerpo óptico realizado por inyección de aluminio, acabado pintado con barniz en polvo. Portalámparas con elemento disipador en aluminio inyectado a presión pintado con barniz en polvo de color negro. Aro para empotrar y aro de protección de material termoplástico; aro antirreflejos de aluminio inyectado a presión pintado con barniz en polvo de color negro. Cristal de protección templado de 4mm de espesor. Sistema de fijación mediante soportes de acero inoxidable.

Adjustable: Luminaire for halogen and high-pressure discharge lamps. Injection-moulded aluminum reflector body with powder-coated finish. Lamp support with die-cast aluminum, black powder-coated heat dissipating element. Thermoplastic recessed ring and screening ring; die-cast aluminum, black powder-coated anti-glare ring. 4 mm tempered glass cover. Stainless steel fixing brackets.

Colores
Colours

30 Blanco Mate
30 Matt White
 02 Gris
02 Grey
 14 Negro Mate
14 Matt Black



Rotación
Rotation Features

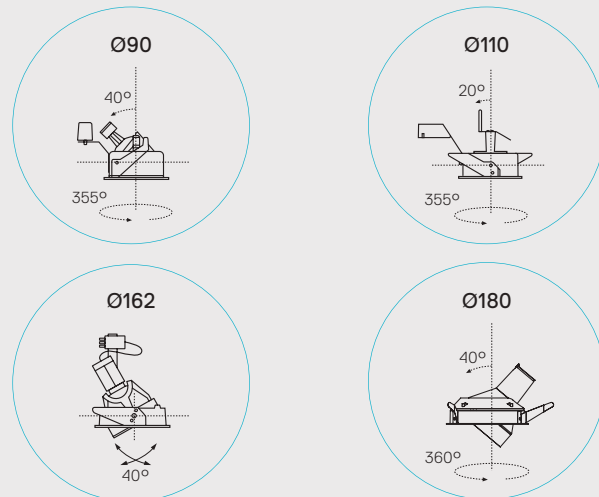

Sistema de bloqueo.
Lock system.

COMPASS

COMPASS Ø90



PAR 16
GZ10
MAX 50W

QT-12
GY6.35
MAX 50W

QR-CBC 51
GX5.3
MAX 50W
- OR -
LED QR-CBC 51
7/10W

COMPASS Ø110

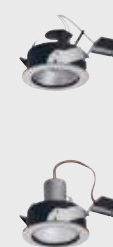

QT-12
GY6.35
MAX 50W

QR-CBC 51
GX5.3
MAX 50W
- OR -
LED QR-CBC 51
7/10W

COMPASS Ø135



QT-12
GY6.35
MAX 100W

CDM-TC
G8.5
MAX 70W

COMPASS Ø162



QT-12
GY6.35
MAX 100W

CDM-TC
G8.5
MAX 70W

QR-111
G53
MAX 100W
- OR -
LED QR-111

HIT-CRI
G12
MAX 150W

COMPASS Ø180



HIT-CRI
G12
MAX 70W

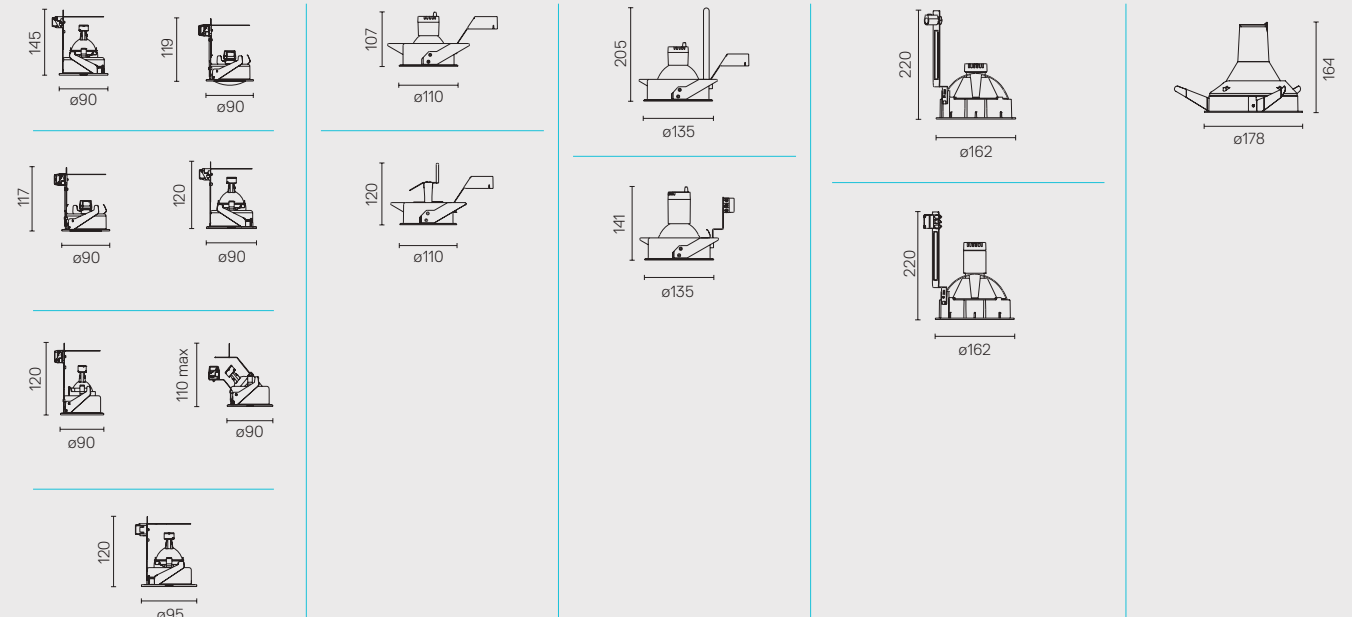

COMPASS

COMPASS



La orientación del empotrable Compass Ø162 está realizado por un revolucionario sistema tipo "compás" que permite la basculación del cuerpo óptico en 40° en todas las direcciones respecto al eje vertical.

Adjustable angle Compass Ø162 fixtures incorporate a revolutionary 'compass-type' tilt system that allows the fixture to be inclined up to 40° from the vertical in any direction.

El proyector incluye un sistema de bloqueo de la orientación del haz luminoso con el fin de evitar posibles movimientos del mismo durante las operaciones de mantenimiento.

The spot includes a mechanism that locks the light adjustment system in order to prevent it shifting during maintenance.



Programa de proyectores de interior para la iluminación de acento disponible en fuentes de luz de tecnología LED de alta potencia. La gran variedad de LEDs, combinada con la disponibilidad de una amplia gama de accesorios, hacen que esta familia de productos se adapte a todo tipo de aplicaciones, y en particular a locales comerciales, pasando por las instalaciones altamente profesionales. Las diferentes aperturas del haz luminoso permiten satisfacer cualquier exigencia luminotécnica. Disponible en versión Dali y con posibilidad de instalación en carril o directa a techo. El particular sistema de fijación en el carril garantiza precisión, versatilidad y facilita el uso.

SOLID PURE

Indoor spotlight programme for accent lighting, available in high power LED technology light sources. The large variety of LEDs, combined with the availability of a wide range of accessories, enable this family of products to adapt to any type of application, and in particular, to commercial premises, as well as highly professional facilities. The different light beam angles satisfy any lumino-technical requirement. Available in Dali version and with possibility of direct ceiling or track mounting. The singular track fixture system guarantees precision, versatility and facilitates use.





SOLID PURE



Luminaria de interior para ser instalada a carril trifásico o sobre techos/paredes disponible con fuentes de luz de tecnología Led de alta potencia y en versión Dali y No Dali.

El cuerpo óptico de la luminaria así como el contenedor de los equipos de alimentación están fabricados en aluminio inyectado a alta presión, acabados en pintura polvo de color blanco, gris o negro. El anillo para la fijación de los reflectores está realizado en material termoplástico de color negro y aloja en su interior un elemento porta accesorios capaz de alojar filtros cromáticos y elementos anti deslumbramiento tipo panel de abeja.

La luminaria a carril incorpora un adaptador a carril trifásico.

El correcto funcionamiento durante la vida útil del módulo Led viene garantizado gracias a un innovador diseño de su sistema de disipación térmica, el cual permite una constante recirculación del flujo del aire en su interior. Para ello se utilizan soluciones con radiadores pasivos (versiones 23/30/35W) y activos (versión 53W) en función del caudal necesario de la recirculación del aire.

A luminaire for indoor use to be mounted on three-phase track or on ceilings/walls, available in high power LED technology light sources and in DALI and non-DALI versions.

The optical housing of the luminaire, as well as the container of the power supply equipment, is manufactured in high-pressure injected aluminium, with white, grey or black finishes. The reflector fastening ring houses an accessory-holder element where chromatic filters and honeycomb type anti-glare elements can be housed.

The perfect operation of the LED module is guaranteed thanks to its heat dissipation system, which permits constant recirculation of the air on the inside. To this end, solutions with passive radiators (23/30/35W versions) and active radiators (53W version) are used depending on the required air recirculation flow.

Colores
Colours

30 Blanco
30 White

14 Negro
14 Black



Rotación
Rotation Features

Puede ser orientado 190° y rotado 360°.
Can be swivelled 190° and rotated 360°.

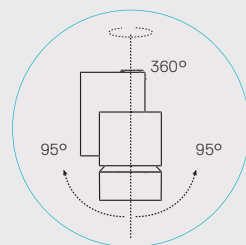

Premios
Awards



reddot design award
winner 2013

SOLID PURE

SOLID PURE
TRACK



SOLID PURE
CEILING



LED ARRAY
23W
2300 lm
3000K/CRI 80

2000 lm
3000K/CRI 90

2500 lm
4000K/CRI 80

LED ARRAY
30W
3300 lm
3000K/CRI 80

2700 lm
3000K/CRI 90

3500 lm
4000K/CRI 80

LED ARRAY
35W
3800 lm
3000K/CRI 80

3100 lm
3000K/CRI 90

4000 lm
4000K/CRI 80

LED ARRAY
53W
5200 lm
3000K/CRI 80

4300 lm
3000K/CRI 90

5500 lm
4000K/CRI 80

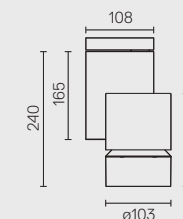
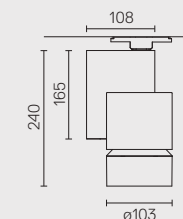

SOLID PURE



Sistema de refrigeración térmica activo para asegurar la recirculación del flujo de aire (disponible para la versión de 53W).

Active thermal cooling system to guarantee air flow recirculation (available for 53W version).

SOLID PURE





Programa proyectores de interior para la iluminación de acento. La gran variedad de posibles fuentes de luz, incluida la última generación de LED, combinada con la disponibilidad de una amplia gama de accesorios, hacen que esta familia de productos se adapte a todo tipo de aplicaciones que van desde el mundo de los locales comerciales y las oficinas, a los ambientes típicamente residenciales, pasando por las instalaciones altamente profesionales como pueden ser las exposiciones en museos. Las diferentes aperturas del haz luminoso, permiten satisfacer cualquier exigencia luminotécnica. Disponible en las versiones: para pared, carril, techo o empotrado. El particular sistema de fijación en el carril garantiza precisión, versatilidad y facilita el uso.

PURE

Family of indoor spotlights for accent lighting. The great variety of possible light sources, even the latest generation of LED, combined with the availability of a wide range of accessories, makes this family of products particularly suitable for any type of application, from commercial premises and offices to typical residential environments or highly professional facilities such as museum exhibitions. With different beam angles, they enable us to meet the needs of any lighting requirement. Available in wall, track, ceiling and recessed mounting versions. The special fixture system on the track ensures precision, versatility and facilitates its use.



DESIGNED BY KNUD HOLSCHER



D38 BUILDING ENTRANCE - SPAIN

PURE SPOT

PURE SPOT



PURE SPOT PRO



Proyector para ser instalado a techo o a carril trifásico. Para lámparas LED, lámparas halógenas de baja tensión y de descarga. Portalámparas cerámico o de tecnopolímero auto-extinguible, con cables eléctricos unipolares aislados Teflón con doble aislamiento transparente. Cuerpo para la lámpara constituido por un elemento disipador realizado en aluminio, colocado sobre el portalámparas, por un anillo que sostiene los reflectores realizado de material termoplástico de color negro y por un vidrio templado de 4mm de espesor. El cuerpo, la tapa de cierre y el soporte orientable de la lámpara son de aleación de aluminio inyectado a presión, con acabados en pintura polvo de color blanco, gris o negro. Adaptador trifásico incluido para la versión a carril.

Luminaire for ceiling or three-phase electric track installation. For LED lamps, very low voltage halogen lamps and discharge lamps. Self-extinguishing ceramic or engineering plastic lamp holders, with single-pole, transparent electric wires with double Teflon insulation. Aluminum body, placed above the lamp holder, black thermoplastic and 4mm tempered glass screen-support ring. Die-cast aluminum alloy body, cover and adjustable lamp support, powder-coated white, grey or black. Thermoplastic three-phase adapter.

Colores
Colours

30 Blanco
30 White

02 Gris
02 Grey

14 Negro
14 Black



Rotación
Rotation Features

Puede ser orientado 180° y rotado 180°.
Can be swivelled 180° and rotated 180°.

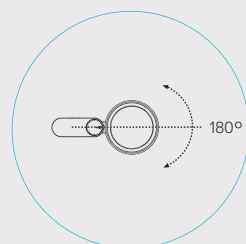
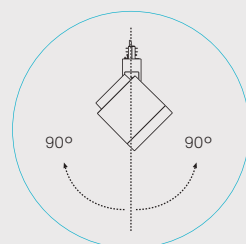

Premios
Awards



reddot design award
winner 2008

DESIGN PLUS

PURE SPOT

PURE 1 SPOT



PURE 1 SPOT PRO



PURE 2 SPOT

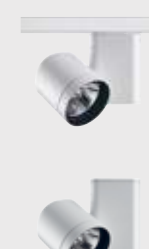

PURE 2 SPOT PRO



PURE 2 SPOT WALL-WASHER



PURE 3 SPOT



PURE 3 SPOT PRO



LED ARRAY
26W
2140 1m
3000K
CRI 80



POWER LED
15,7W
1400 1m
2700K/CRI 80
3000K/CRI 80



QR-CBC 51
GX5.3
MAX 50W
- OR -
LED QR-CBC 51
7/10W



PHOSPHOR LED
19,5W
2000 1m
3000K/CRI 80
17W
1400 1m
3000K/CRI 98



QT-12
GY6.35
MAX 50W



CDM-TM
PGJ5
20/35W



HI PAR 51
GX10
20/35W



QT-12
GY6.35
MAX 100W



CDM-TC
G8.5
35/70W



QR-111
G53
MAX 100W
- OR -
LED QR-111



HIT-CRI
G12
35/70/150W



CDM-R111
GX8.5
35/70W

Pure 1 Spot

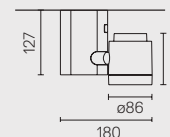

Pure 2 Spot

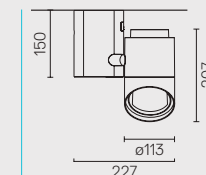
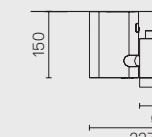

Pure 3 Spot

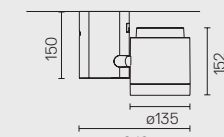

Pure 1 Spot Pro

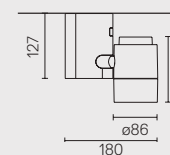

Pure 2 Spot Pro

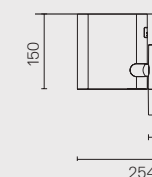

Pure 3 Spot Pro

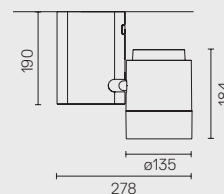

PURE SPOT

PURE SPOT



El mecanismo de ocultación del necesario adaptador trifásico se acciona sin necesidad de herramientas específicas gracias a un dispositivo a presión integrado en el lateral del cuerpo principal de fácil funcionamiento. Cuando el mecanismo se encuentra en su posición de trabajo, el adaptador permanece oculto dentro del cuerpo principal.

The retractable 3-phase adaptor can be actuated without using any special tool thanks to the easy-to-use push device integrated at the side of the main body. In its working position, the adaptor remains hidden inside the main body.

Una vez la luminaria está instalada sobre el carril trifásico, el adaptador permanece oculto dentro del cuerpo principal. La orientación del haz de luz se realiza desde el cuerpo óptico permaneciendo el resto de la luminaria fija sobre el carril trifásico.

After the installation of the luminaire on the 3-phase track, the adaptor remains hidden inside the main body. The beam light adjustment is made directly on the optical body, while the rest of the luminaire is fixed and fastened on the 3-phase track.

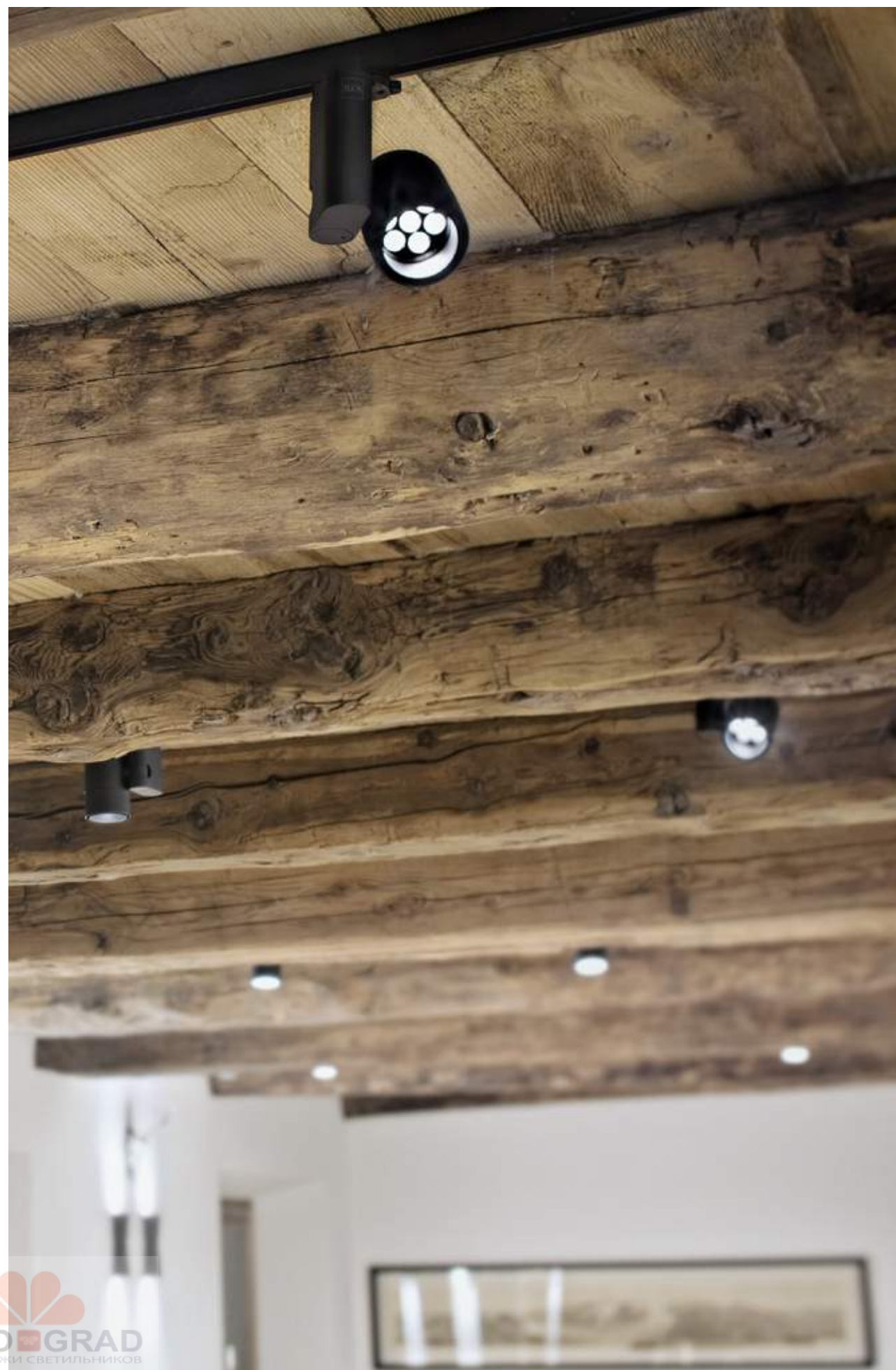

PURE SPOT

PURE SPOT



El proyector incluye un sistema de bloqueo de la orientación del haz luminoso con el fin de evitar posibles movimientos del mismo durante las operaciones de mantenimiento.

The spot includes a mechanism that locks the light adjustment system in order to prevent it shifting during maintenance.



Todas las versiones del Pure Spot y del Pure Spot Pro son dimables desde el 10% al 100% de su potencia máxima gracias a un potenciómetro incorporado en el producto.

All halogen versions of Pure Spot and Pure Spot Pro are dimmable from 10% to 100% of full output using built-in potentiometer.



Las versiones para su instalación en superficie, incorporan un mecanismo totalmente oculto una vez la luminaria está instalada, de fácil montaje, sin necesidad de herramientas específicas.

The surface installation version of the luminaire includes a mechanism which completely disappears from sight after being installed. Easy assembly without using any specific tool.





PURE DOWNLIGHT

PURE DOWNLIGHT TRIM



PURE DOWNLIGHT NO TRIM



Luminaria empotrable de interior. Para lámparas LED, halógenas de baja tensión, directas a red y de descarga. Portalámparas cerámico o de tecnopolímero autoextinguible, con cables eléctricos unipolares aislados Teflón con doble aislamiento transparente. Cuerpo para la lámpara constituido por un elemento disipador realizado en aluminio, colocado sobre el portalámparas, por un anillo que sostiene los reflectores realizado en material termoplástico de color negro y por un vidrio templado de 4mm de espesor. El cuerpo, la tapa de cierre y el soporte orientable de la lámpara son de aleación de aluminio inyectado a presión, con acabados en pintura polvo de color blanco, gris o negro.

Recessed luminary for indoor application. For LED lamps, low voltage halogen lamps, direct mains power and discharge lamps. Self-extinguishing ceramic or engineering plastic lamp holders, with single-pole, transparent electric wires with double Teflon insulation. Aluminum body, placed above the lamp holder, black thermoplastic and 4mm tempered glass screen-support ring. Die-cast aluminum alloy body, cover and adjustable lamp support, powder-coated white, grey or black.

Colores
Colours

Pure Downlight Trim

30 Blanco
30 White

02 Gris
02 Grey

14 Negro
14 Black



Pure Downlight No Trim



Rotación
Rotation Features

Puede ser rotado 360° y orientado 60°.
Can be rotated 360° and swivelled 60°.

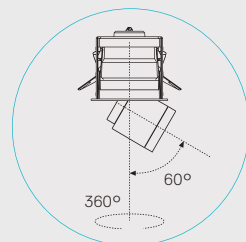

PURE DOWNLIGHT

PURE 1
DOWNLIGHT
TRIM



PHOSPHOR LED
13,6W
1490 lm
3000K/CRI 80
11,9W
1057 lm
3000K/CRI 95

QT-12
GY6.35
MAX 50W

QR-70
BA15d
MAX 50W

PURE 1
DOWNLIGHT
NO TRIM



POWER LED
15,7W
1400 lm
2700K/CRI 80
3000K/CRI 80

QR-CBC 51
GX5.3
MAX 50W
- OR -
LED QR-CBC 51
7/10W

CDM-TM
PGJ5
MAX 35W

HI PAR 51
GX10
MAX 35W

PURE 2
DOWNLIGHT
TRIM



QT-12
GY6.35
MAX 100W

CDM-TC
G8.5
MAX 70W

PURE 2
DOWNLIGHT
NO TRIM



PURE 3
DOWNLIGHT
TRIM



QR-111
G53
MAX 100W
- OR -
LED QR-111

HIT-CRI
G12
MAX 150W

CDM-R111
GX8.5
MAX 70W

PURE 3
DOWNLIGHT
NO TRIM



Pure Downlight
Trim

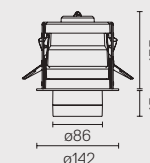

Pure Downlight
No Trim

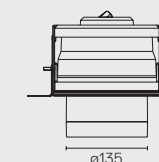
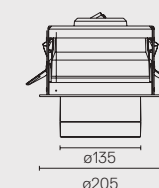
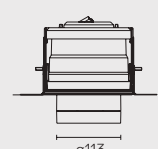
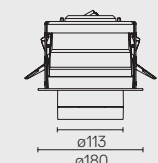
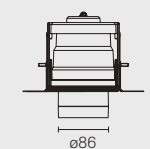

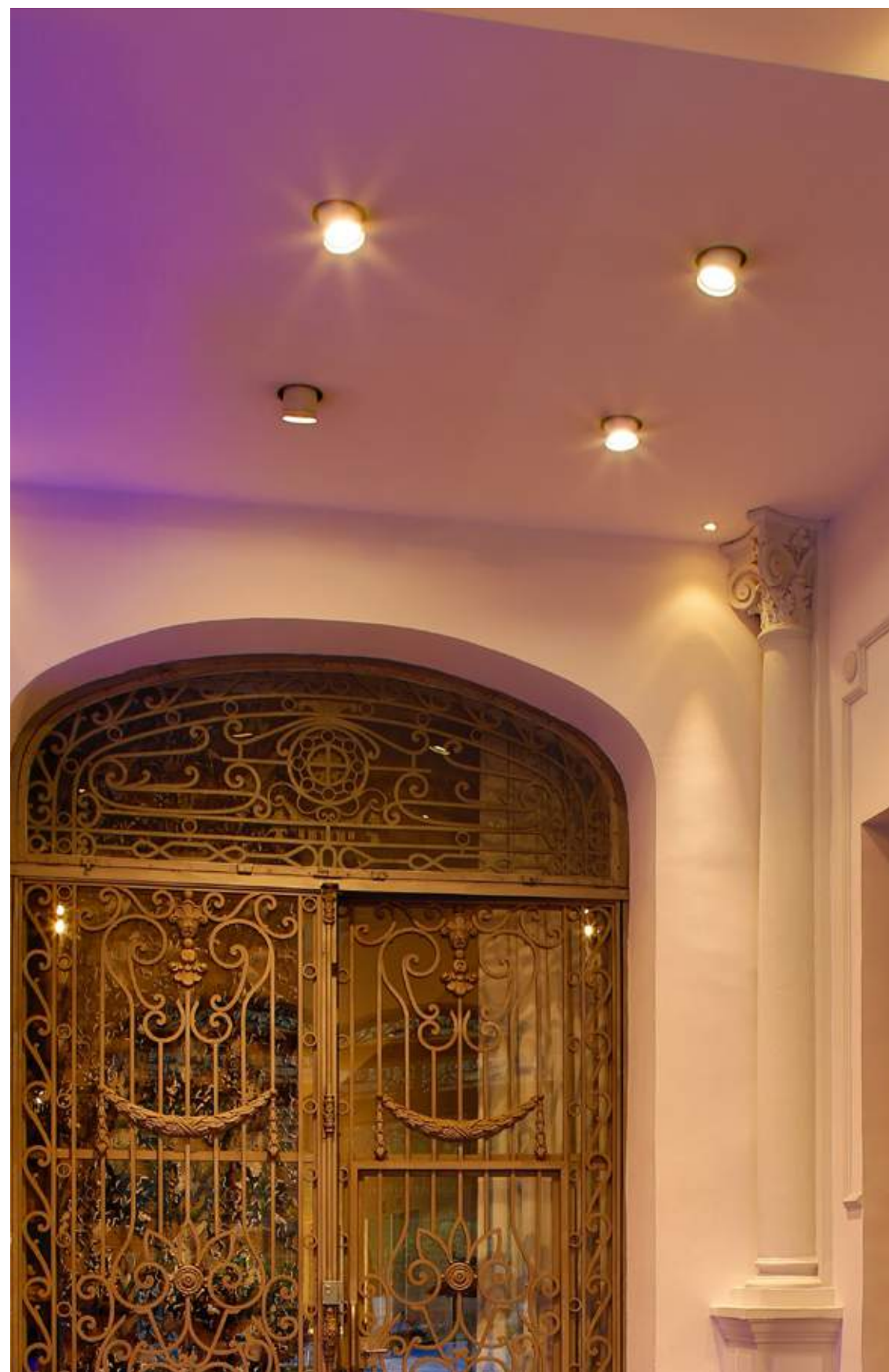

PURE DOWNLIGHT

PURE DOWNLIGHT

TRIM



Sistema de fijación de la luminaria diseñado para falsos techos de hasta 30mm de espesor. La instalación de la luminaria se realiza fácil y rápidamente sin necesidad de herramientas específicas.

Luminaire fixing system for ceiling thicknesses of 0-30mm. Fast and easy luminaire installation. No special tools required.

NO TRIM



Accesorio para instalación de la luminaria totalmente enrasada a techo sin aro de empotramiento.

Accessory for a installation on the surface of the ceiling without using any rings for recessed installation.



PHARMACY - SPAIN



CUSTO BARCELONA - SPAIN

Sistema de carril modular a muy baja tensión y de dimensiones especialmente compactas para instalaciones a pared, techo y suspensión. Diferentes aplicaciones lo hacen adecuado para la iluminación en diversas áreas: de trabajo, residencial, exposiciones. Un sistema simple permite una rápida conexión a la red eléctrica. Los aparatos pueden montarse en cualquier posición del carril y moverlos o desmontarlos sin ayuda de utensilios especiales.

LIGHTLIGHT®

Modular track system with very low voltage and with especially compact dimensions suitable for wall, ceiling and suspension mounting. Different applications make it suitable for lighting in different areas: work, residential, exhibitions. A simple system allows for fast connection to the power supply. The devices can be mounted in any position on the track and they can be moved or removed without having to use special tools.



DESIGNED BY HANS BUSCHFELD



PRIVATE KITCHEN - GERMANY

LIGHTLIGHT® WALL

Poster

Luminaria universal para cuadros, con soporte regulable. Luz antideslumbrante con distribución uniforme. La altura recomendada de instalación es 2300-2700mm. La elección de la fuente de luz depende del tamaño del cuadro y de la distancia de la luminaria a la pared.

Shop

Luminaria de pared para iluminación de cuadros, estanterías y paredes. La familia Shop es similar a la familia Poster pero sin el soporte para cuadros. La modificación del soporte no es posible.

El carril LightLight® Wall se puede montar también en el techo, por tanto, la familia Shop puede ser instalada como una luminaria suspendida. Las varillas se pueden cortar a medida.

Shop-W

Luminaria de pared decorativa para la iluminación de acento en las zonas próximas a la pared. Debe prestarse atención a la radiación térmica, si el carril está montado cerca del techo.

Angle

Luminaria clásica para iluminación de cuadros. Tanto la altura de la lámpara como la altura del soporte del cuadro son regulables. Muy buena iluminación hasta 500x700mm. La luminaria puede ser ajustada para cumplir con los requisitos de iluminación de los museos.

La altura ideal del carril para la familia Angle es 2500-3000mm. En el caso de alturas de montaje de hasta 3500mm, la luminaria puede ser suministrada en longitudes especiales. La distancia de la luminaria a la pared no se puede cambiar. Para cuadros de paisajes de más de 700mm de ancho, utilizar dos luminarias Angle.

Max-W

Luminaria direccional para la iluminación de esculturas y de iluminación general. Excelente antideslumbramiento. Ideal para su aplicación en tiendas, escaparates, museos y exposiciones, donde es necesario un alto flujo luminoso. Debe prestarse atención a la radiación térmica si el carril está montado cerca del techo.

Poster

Universal picture luminaire with adjustable picture hanging. Glare-free light, uniform light distribution. The ideal track height is 2300-2700mm. The choice of light source depends on the size of the picture and the distance from the luminaire to the picture.

Shop

Wall and shelf luminaire for illumination of pictures, shelves, walls and worktop surfaces. Shop is comparable to Poster, but without the integral picture hanger. Retrofit of hanger not possible.

The LightLight® Wall track can also be mounted flat on the ceiling. Shop can then be applied as a pendant luminaire. The rods can be shortened.

Shop-W

Decorative wall luminaire for scalloped accent lighting of adjacent wall area. Attractive applied in groups. Attention should be paid to thermal radiation, if the track is mounted close to the ceiling.

Angle

Classic picture luminaire, both height of the lamp and height of picture rod are adjustable. Extremely good illumination up to 500x700mm format. The luminaire can be adjusted to fulfill museum lighting requirements.

The ideal track height for Angle is 2500-3000mm. In the case of mounting heights of up to 3500mm the luminaire can be supplied in custom lengths. The distance of the luminaire from the wall must not be changed. For landscape pictures wider than 700mm use two Angle luminaires.

Max-W

Directional spotlight for the illumination of sculptures and for general accent lighting. Excellent glare-free. For application in retail spaces, shop-windows displays, museums and exhibitions, where high lumen packages are required. Attention should be paid to thermal radiation if the track is mounted close to the ceiling.

Colores / Colours
 W Blanco / W White
 A Aluminio Anodizado / A Anodized Aluminium
 B Negro Anodizado / B Anodized Black
 P Aluminio Pulido / P Polished Aluminium

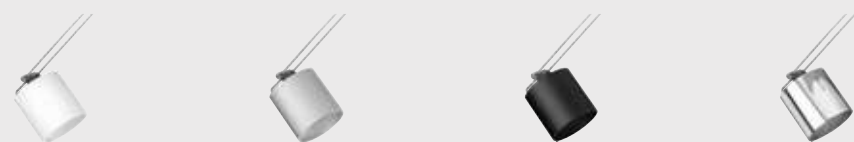

LIGHTLIGHT® WALL

TUBE	POINT	MINITUBE	DISC 70	DISC 111	B15	HALB
QR-CBC 51 clear/frosted GX5.3 20/35/50W - OR - LED QR-CBC 51 4/7/10W	QR-CBC 25 clear/frosted GZ4 20/35W	QR-70 BA15d 20/50W	QR-111 G53 20/50/60W - OR - LED QR-111	QR-C 38 clear/frosted B15d 20/35W - OR - LED QR-C 38 6W 2700K CRI 90		

POSTER

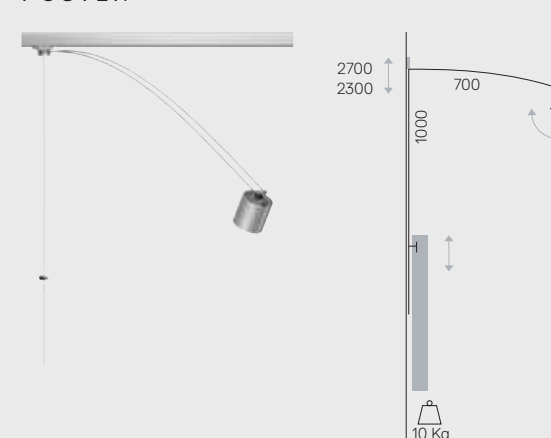

SHOP

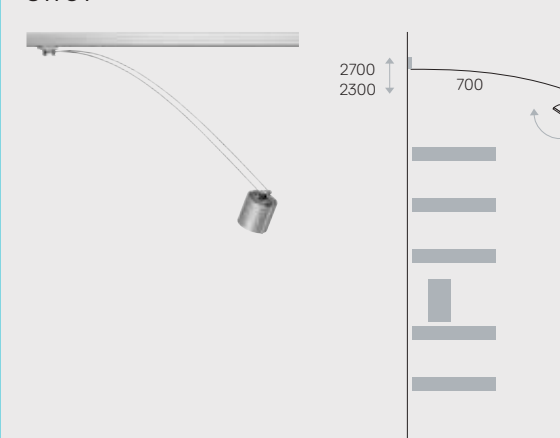

SHOP-W

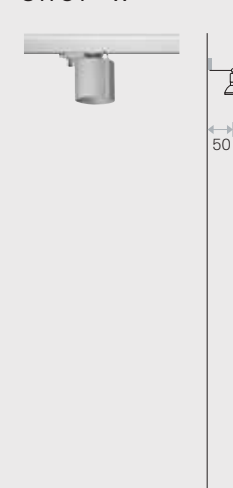

ANGLE

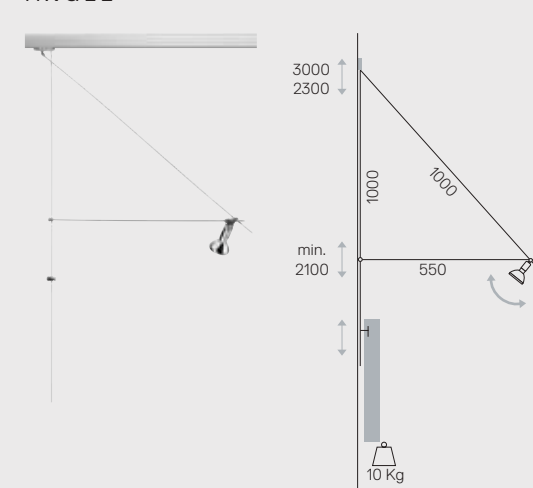

MAX-W

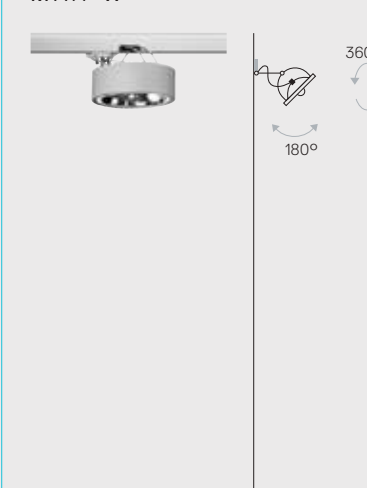



Lámparas halógenas reflectoras con cristal de seguridad arenado con el fin de mejorar la distribución luminosa especialmente cuando se ilumina en distancias cortas.

Halogen lamps and diffuser with sandblasted safety glass ensure an even light distribution, especially for short distance lighting.







PRIVATE HOUSE - GERMANY

256



PRIVATE RESIDENCE - DENMARK

257

LIGHTLIGHT® PEND / CEILING

Flex

Luminaria direccional para iluminación general e iluminación de acento. Orientable 360° y basculante 180°. Diseñada para su aplicación en tiendas, escaparates, exposiciones, museos y espacios expositivos.

Max

Luminaria direccional para iluminación general e iluminación de acento. Orientable 360° y basculante 180°. Debe prestarse atención a la radiación térmica si el carril está montado cerca del techo. Diseñado para su aplicación en tiendas, escaparates, exposiciones, museos y espacios expositivos, donde es necesario un alto flujo luminoso.

Pinpin

Luminaria suspendida para iluminación de mesas y mostradores que no produce deslumbramiento. Dispone de dos fuentes de luz ajustables (0° - 25°) contenidas en un cilindro doble. El espacio ideal entre la luminaria y la mesa es de 600-700mm. Las varillas se pueden acortar. Longitudes especiales disponibles bajo pedido. Lámpara recomendada de 20 ó 35W, 60° de IRC.

Shop-V 100

Luminaria suspendida para iluminación de mesas y mostradores. El espacio ideal entre la luminaria y la mesa es de 600 a 700mm. Las varillas se pueden acortar. Longitudes especiales bajo pedido.

Spot 5

Luminaria direccional para iluminación general e iluminación de acento. Orientable 360° y basculante 180°. Diseñada para su aplicación en tiendas, escaparates, exposiciones, museos y espacios expositivos.

Balance 50

Luminaria de iluminación general para mostradores y mesas de trabajo. Disponible en dos tamaños. Solo apto para la aplicación con sistema de carril LightLight® Pend.

Flex

Directional spotlight for general and accent lighting. Rotatable 360° and tiltable 180°. Designed for application in retail spaces, shop-windows displays, museums and exhibition spaces.

Max

Directional spotlight for general and accent lighting. Rotatable 360° and tiltable 180°. Attention should be paid to thermal radiation if the track is mounted close to the ceiling. Designed for application in retail spaces, shop-windows displays, museums and exhibition spaces, where high lumen packages are required.

Pinpin

Glare-free table and counter luminaire. Two adjustable (0° - 25°) light sources contained in a double cylinder for extended beam spread. The ideal spacing between luminaire and table surface is 600-700mm. The rods can be shortened. Special lengths available on request. Recommended lamp 20 or 35W, 60° IRC.

Shop-V 100

Pendant luminaire for application above tables and counters. The ideal spacing between luminaire and table surface is 600 to 700mm. Rods can be shortened. Special lengths on request.

Spot 5

Directional spotlight for general and accent lighting. Rotatable 360° and tiltable 180°. Designed for application in retail spaces, shop-windows displays, museums and exhibition spaces.

Balance 50

Project luminaire for tables, counters and general lighting tasks. Attractive applied in groups. Only suitable for application with pendant system LightLight® Pend.

Colores
Colours

□ W Blanco
W White

■ A Aluminio Anodizado
A Anodized Aluminium

■ B Negro Anodizado
B Anodized Black

■ P Aluminio Pulido
P Polished Aluminium



LIGHTLIGHT® PEND / CEILING

TUBE



POINT



MINITUBE



DISC 70



SHORT



DISC 111

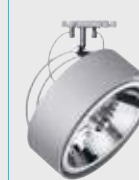

PINPIN



B15



HALB



QR-CBC 51
clear/frosted
GX5.3
20/35/50W
- OR -
LED QR-CBC 51
4/7/10W



QR-CBC 25
clear/frosted
GZ4
20/35W



QR-70
BA15d
20/50W



QR-48
GY4
20W



QR-111
G53
20/50/60W
- OR -
LED QR-111



QR-CBC 51
clear/frosted
GX5.3
20/35W
- OR -
LED QR-CBC 51
4W



QR-C 38
clear/frosted
B15d
20/35W
- OR -
LED QR-C 38
6W
2700K
CRI 90

FLEX

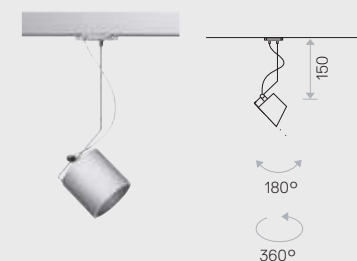

MAX

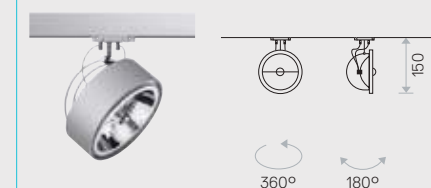

PINPIN

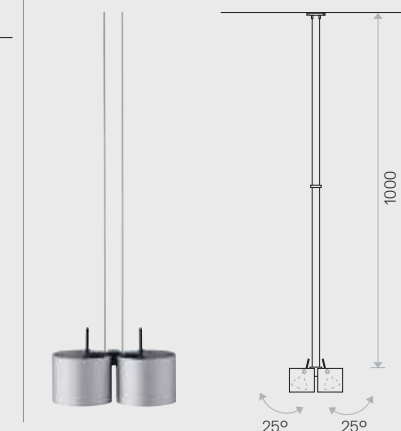

SHOP-V 100



SPOT 5



BALANCE 50

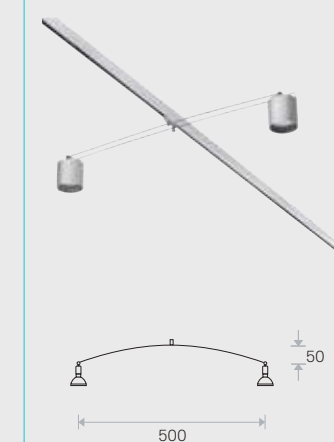



PRIVATE HOUSE - GREECE



262

PRIVATE HOUSE - GREECE



263

LIGHTLIGHT® MONO

Shop Mono
Luminaria de iluminación general para ser instalada a pared con sistema de montaje empotrado o de superficie. Luminaria empotrada con caja de instalación a pared y cubierta. El transformador debe ser pedido por separado. La versión montada en superficie se suministra con transformador electrónico dimable.

Max Mono
Proyector orientable de iluminación general y de acento para empotrar o instalar en superficie. La versión empotrable se suministra con caja de instalación y cubierta. El transformador se debe pedir por separado. La versión para montar en superficie se suministra con transformador electrónico regulable integral.

Pinpin Mono
Luminaria para iluminación de mesas y mostradores para ser instalada a pared con sistema de montaje empotrado o de superficie que no produce deslumbramiento. Dispone de dos fuentes de luz ajustables (0° - 25°) contenidas en un cilindro doble. La versión empotrada se suministra con caja de instalación a pared y cubierta. El transformador debe de pedirse por separado. La versión montada en superficie se suministra con transformador electrónico dimable. Lámpara recomendada de 20 ó 35W, 60° de IRC.

Shop Mono
Wall and pendant luminaire for general and accent lighting for recessed or surface mounting. Recessed luminaire supplied with wall box and cover plate. Transformer to be ordered separately. Surface-mounted version supplied with integral dimmable electronic transformer.

Max Mono
Directional spotlight for general and accent lighting for recessed or surface mounting. Recessed luminaire supplied with wall box and cover plate. Transformer to be ordered separately. Surface-mounted version supplied with integral dimmable electronic transformer.

Pinpin Mono
Glare-free table and counter luminaire for recessed or surface mounting. Two adjustable (0°-25°) light sources contained in a double cylinder for extended beam spread. Recessed luminaire supplied with wall box and cover plate. Transformer to be ordered separately. Surface-mounted version with dimmable electronic transformer. Recommended lamp 20/35W, 60° IRC.

Colores / Colours
 W Blanco / W White
 A Aluminio Anodizado / A Anodized Aluminium
 B Negro Anodizado / B Anodized Black
 P Aluminio Pulido / P Polished Aluminium

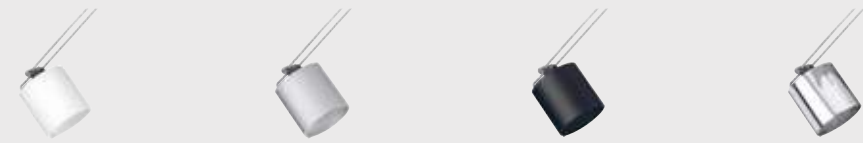

Installation | Wall-Mounted | Recessed



Installation | Ceiling-Mounted | Recessed



Installation | Wall-Mounted | Surface



Installation | Ceiling-Mounted | Surface

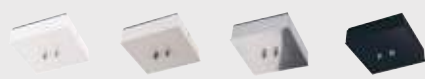

LIGHTLIGHT® MONO

TUBE	POINT	MINITUBE	DISC 70	DISC 111	PINPIN	B15	HALB
QR-CBC 51 clear/frosted GX5.3 20/35/50W - OR - LED QR-CBC 51 4/7/10W		QR-CBC 25 clear/frosted GZ4 20/35W	QR-70 BA15d 20/50W	QR-111 G53 20/50/60W - OR - LED QR-111	QR-CBC 51 clear/frosted GX5.3 20/35W - OR - LED QR-CBC 51 4W	QR-C 38 clear/frosted B15d 20/35W - OR - LED QR-C 38 6W 2700K CRI 90	

PINPIN MONO RECESSED / SURFACE

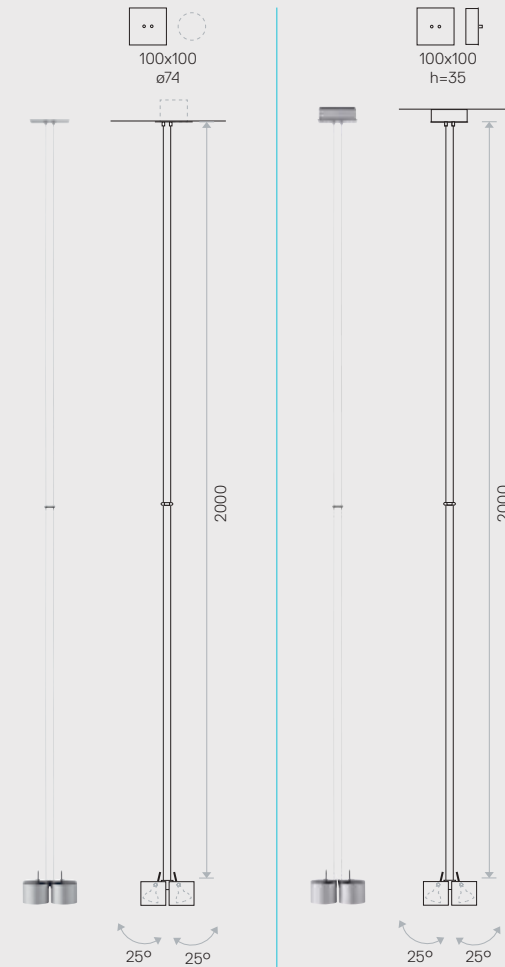

SHOP MONO RECESSED / SURFACE

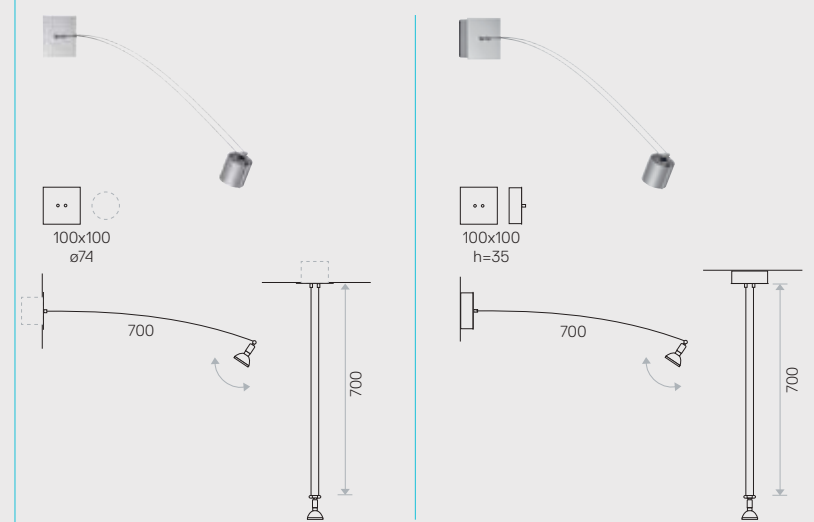

MAX MONO RECESSED / SURFACE

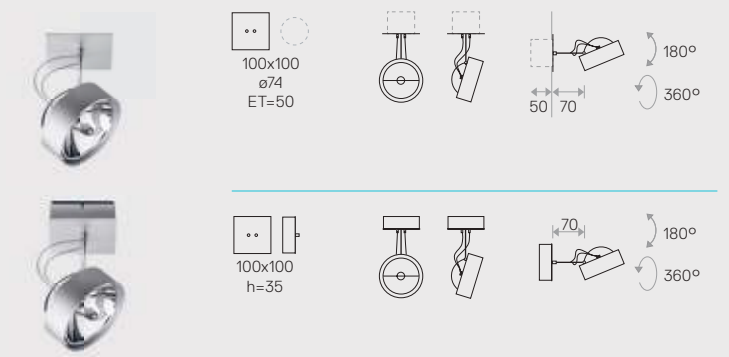



FLOS SHOWROOM - GERMANY

Familia de aparatos de iluminación para instalaciones de interior, empotrados o al techo. Una perfecta integración en los ambientes viene garantizada por la posibilidad de elegir entre una gran variedad de acabados. También disponibles con las nuevas lámparas LED. Con un alto apantallamiento, Kap ofrece un gran confort visual.

KAP

Recessed or ceiling mounted family of lighting devices, for indoor installation. The choice of a large variety of finishes guarantees perfect integration into the environment. Also available with the new LED lamps. With high cut-off, Kap offers great visual comfort.





EASY KAP



Luminaria para ser instalada empotrada en techos para lámparas halógenas, de halogenuro metálico y LED.

La versión Easy Kap dispone de cuerpo inyectado en zamak con acabado en pintura líquida y diámetro exterior de 105mm con cristal difusor opal. No necesita premarco de instalación. Portalámparas con elemento disipador en aluminio inyectado y aro de empotramiento del cuerpo óptico en material termoplástico.

Luminaire for recessed mounting on ceilings for halogen, metal halide and LED lamps.

The Easy Kap version, incorporates body injected in zamak with liquid paint finish and outer diameter of 105mm with opal glass diffuser. Pre-frame installation not necessary. Lampholders with heatsink element in injected aluminium and embedment ring of the optical body in thermoplastic material.

Colores
Colours

□ B1 Blanco
B1 White



■ GL Oro Mate
GL Matt Gold



■ BU Azul
BU Blue



■ 74 Negro
74 Black



■ CU Cobre
CU Copper



EASY KAP

EASY KAP
Ø105 FIXED



EASY KAP
Ø105
WALL-WASHER



LED ARRAY
10,5W
720 lm
2700K/CRI 90
10,5W
930 lm
3000K/CRI 80



QR-CBC 51
GX5.3
MAX 50W
- OR -
LED QR-CBC 51
7W



HI PAR 51
GX10
MAX 35W

Easy Kap Fixed

LED

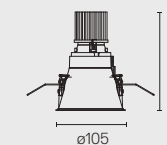

QR-CBC 51

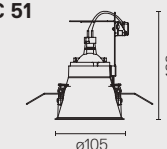

HI PAR 51

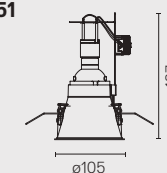

Easy Kap Wall-Washer

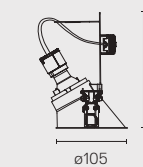
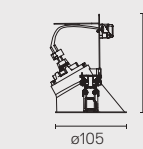
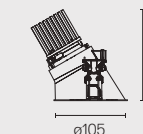

EASY KAP



Efecto No Trim gracias a un nuevo sistema de montaje. Fácil mantenimiento de la lámpara sin necesidad de herramientas gracias a su montaje en bayoneta.

Total No Trim effect achieved due to a new installation system. The bayonet-based assembly allows to replace the lamp without using any particular tools.

EASY KAP





KAP



Luminaria para ser instalada empotrada en techos para lámparas halógenas y de halogenuro metálico y LED.

La versión Kap dispone de cuerpo inyectado en aluminio con acabado en pintura líquida. Está disponible en dos diámetros: 105mm y 145mm. Óptica principal realizada en aluminio anodizado brillo con elemento difusor realizado en cristal borosilicato.

Portalámparas con elemento disipador en aluminio inyectado y aro de empotramiento del cuerpo óptico en material termoplástico.

Luminaire for recessed mounting on ceilings for halogen, metal halide and LED lamps.

The Kap version incorporates body injected in aluminium with liquid paint finish. It is available in two sizes: 105mm and 145mm.

Main view made of anodized gloss aluminium with diffuser element made in borosilicate glass.

Lampholders with heatsink element in injected aluminium and embedment ring of the optical body in thermoplastic material.

Colores
Colours

B1 Blanco
B1 White

GL Oro Mate
GL Matt Gold

BU Azul
BU Blue

74 Negro
74 Black

CU Cobre
CU Copper



Accesorios
Accessories

Marco de instalación No Trim Kap ø145/
ø145 Wall-Washer.

Installation frame No Trim Kap ø145/
ø145 Wall-Washer.



Can de instalación para cemento del Kap
ø105/ø145.

Installation can for concrete Kap ø105/ø145.



KAP

KAP Ø105



PHOSPHOR LED
15,6W
1300 lm
2700K/CRI 98
11,7W
1300 lm
3000K/CRI 80



QT-12
GY6.35
MAX 50W



CDM-TC
G8.5
MAX 35W

KAP 105 SQUARE



PHOSPHOR LED
17W
1400 lm
2700K/CRI 98
19,5W
2000 lm
3000K/CRI 80



QR-CBC 51
GX5.3
MAX 50W
- OR -
LED QR-CBC 51
7W



HI PAR 51
GX10
MAX 35W

KAP Ø145



KAP Ø145 DEEP



PHOSPHOR LED
17W
1400 lm
2700K/CRI 98
19,5W
2000 lm
3000K/CRI 80



QT-12
GY6.35
MAX 65W IRC



CDM-TC
G8.5
MAX 70W

KAP Ø145 WALL-WASHER



Kap Ø105

LED

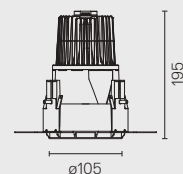

QT-12

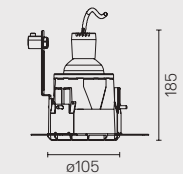

CDM-TC

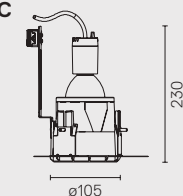

Kap 105 Square

LED

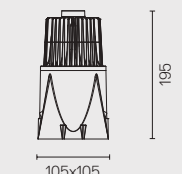

QR-CBC 51

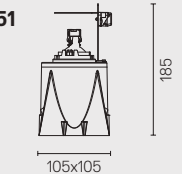

HI PAR 51

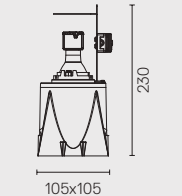

Kap Ø145

LED

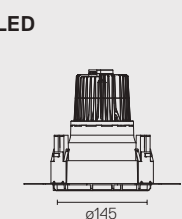

QT-12/
CDM-TC

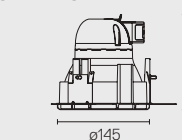

Kap Ø145 Deep

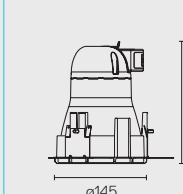
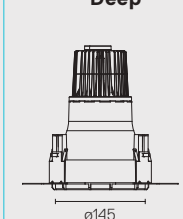

Kap Ø145 Wall-Washer

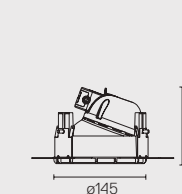
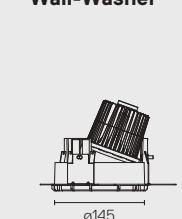

KAP

KAP



La luminaria incluye en su cuerpo principal un elemento radiador con el fin de controlar la correcta temperatura de trabajo de la misma.

The main body of the luminaire contains a radiator for temperature control.



El cuerpo de empotramiento incorpora un difusor realizado en material termoplástico para obtener una perfecta distribución de luz en planos horizontales.

The remote housing includes a thermoplastic diffuser which ensures a perfect light distribution on horizontal surfaces.

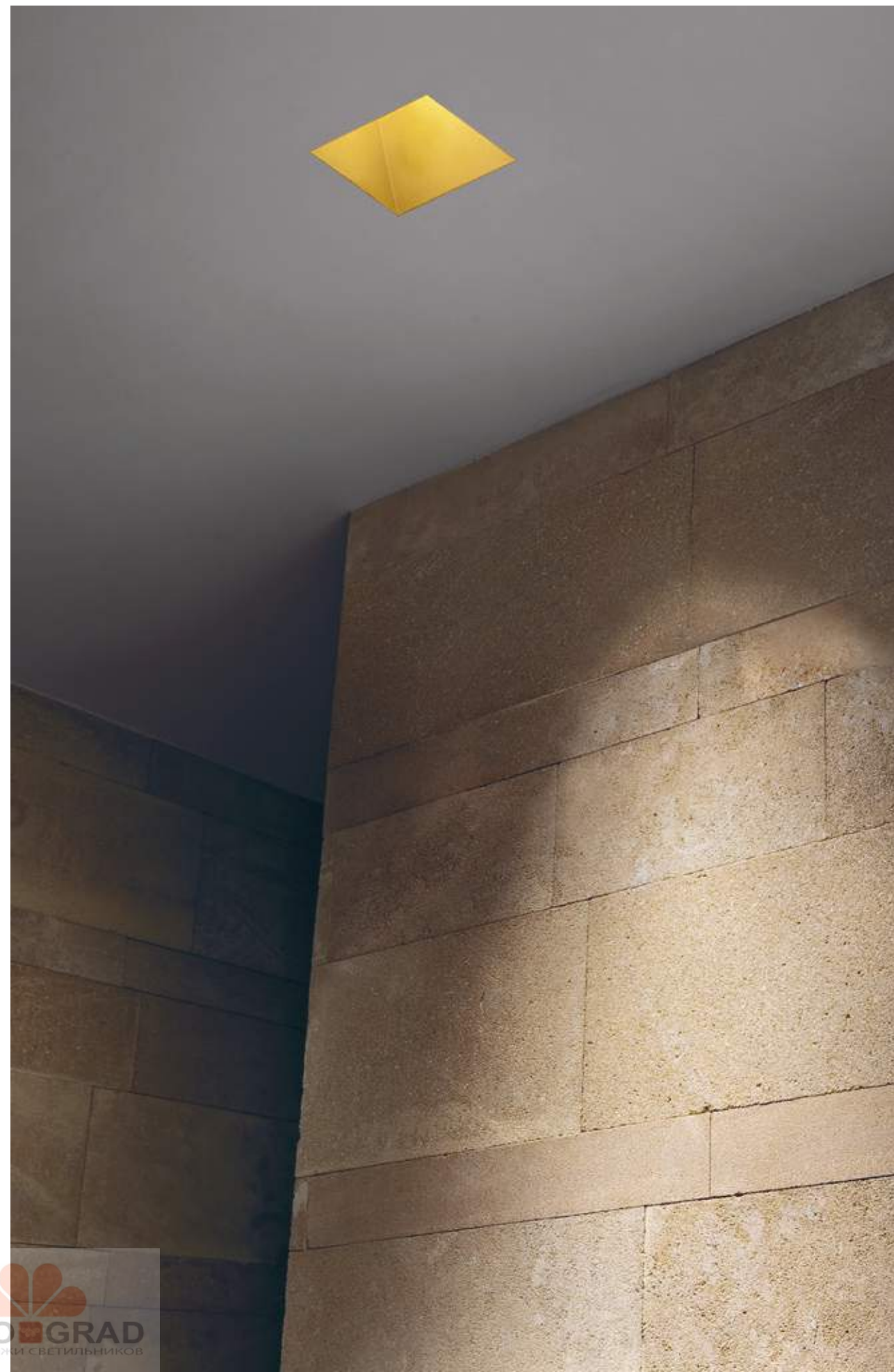

KAP

KAP

VIRGIN ACTIVE - PORTUGAL



282

VIRGIN ACTIVE - ITALY



283

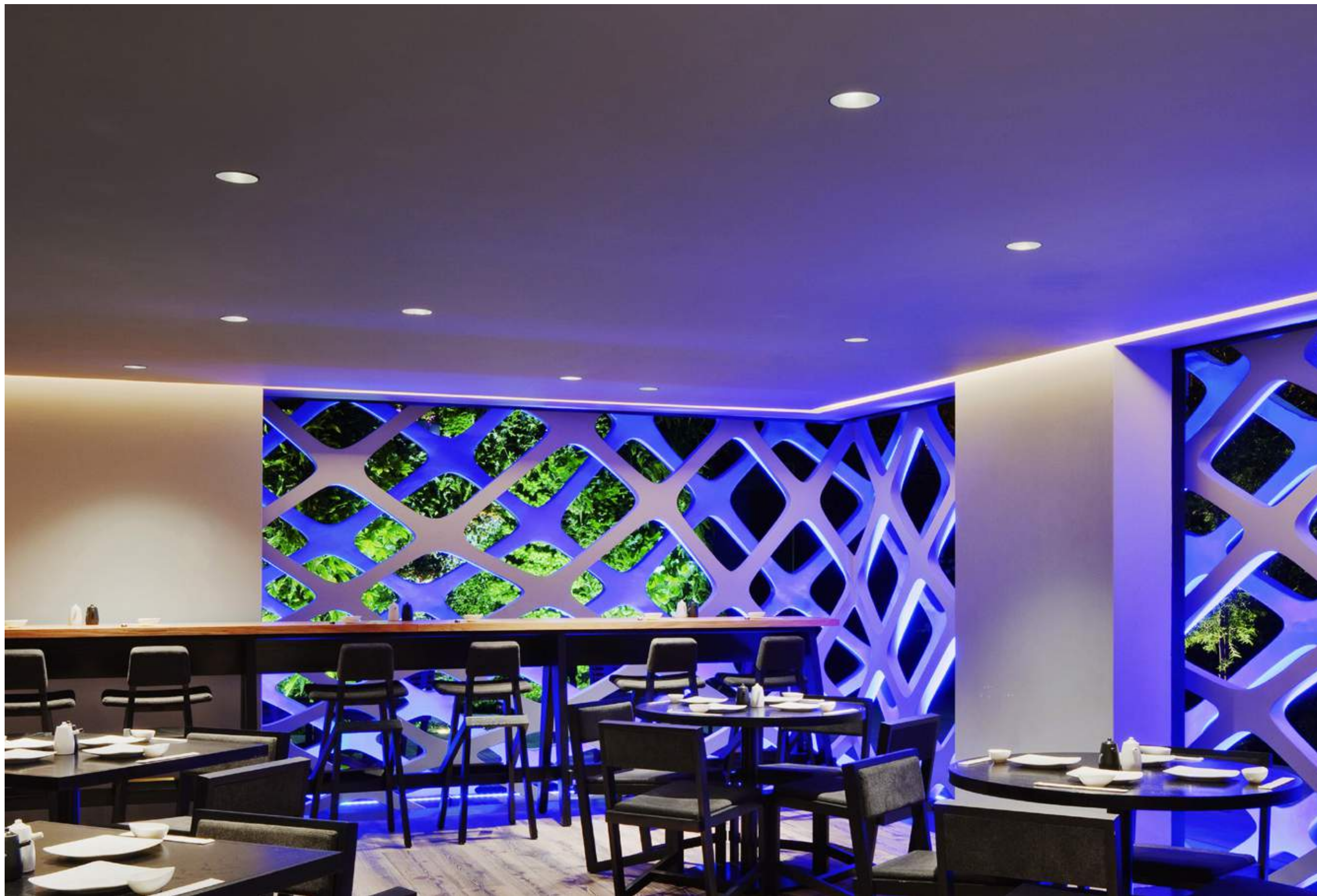

RESTAURANT TORI-TORI - MEXICO

KAP SURFACE / SUSPENSION



Luminaria de iluminación directa para ser instalada a techo, a pared o suspendida. Cuerpo de la luminaria realizado en aluminio extruido. La versión con LED dispone de un reflector interior realizado en policarbonato pintado por la parte interna. Además incorpora una lente difusora realizada en policarbonato opal para ofrecer una luz uniforme. Las versiones para lámpara halógena disponen de reflector realizado en aluminio pintado y cristal difusor realizado en cristal con acabado arenado. Disponibles en combinación de acabados exteriores anodizados o pintados y acabados interiores del reflector.

Luminaire for direct lighting to be installed on ceilings, wall or in suspension. Body of the luminaire made of extruded aluminium. The LED version has an interior reflector made of polycarbonate painted inside. Besides, it incorporates a diffuser lens made of opal polycarbonate which offers a uniform light. The halogen lamp versions have a reflector made of painted aluminium and a glass diffuser made of glass with sandblasted finish. Combinations of exterior finishes available anodized or painted and the interior finishes of the reflector.

Colores
Colours

Exterior / Outside
11 Blanco
11 White

AS Aluminio Satinado
AS Brushed Aluminium

AN Negro
AN Black

B3 Marrón
B3 Brown

Interior / Inside
Blanco
White

Oro Mate
Matt Gold

Azul
Blue

Negro
Black



KAP SURFACE / SUSPENSION



POWER LED
9W
850 lm
3000K
CRI 80

QT-14
G9
MAX 48W ES

QT-14
G9
MAX 2x33W ES

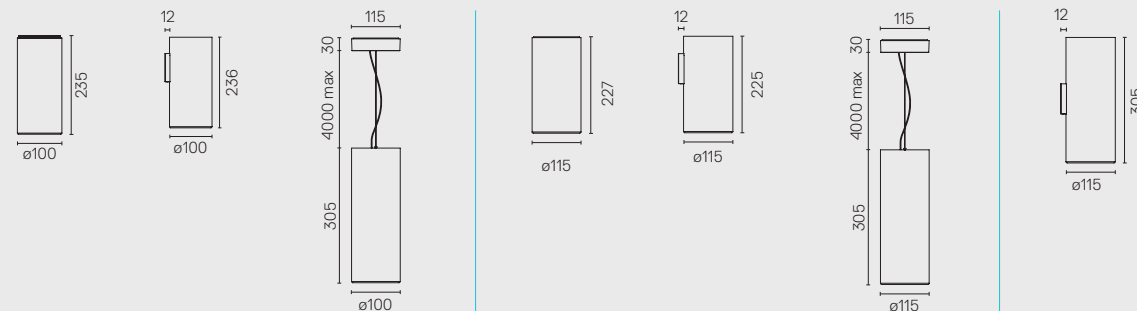



La luminaria incorpora un difusor realizado en material termoplástico para obtener una perfecta distribución de luz en planos horizontales.

The luminaire includes a thermoplastic diffuser which ensures a perfect light distribution on horizontal surfaces.



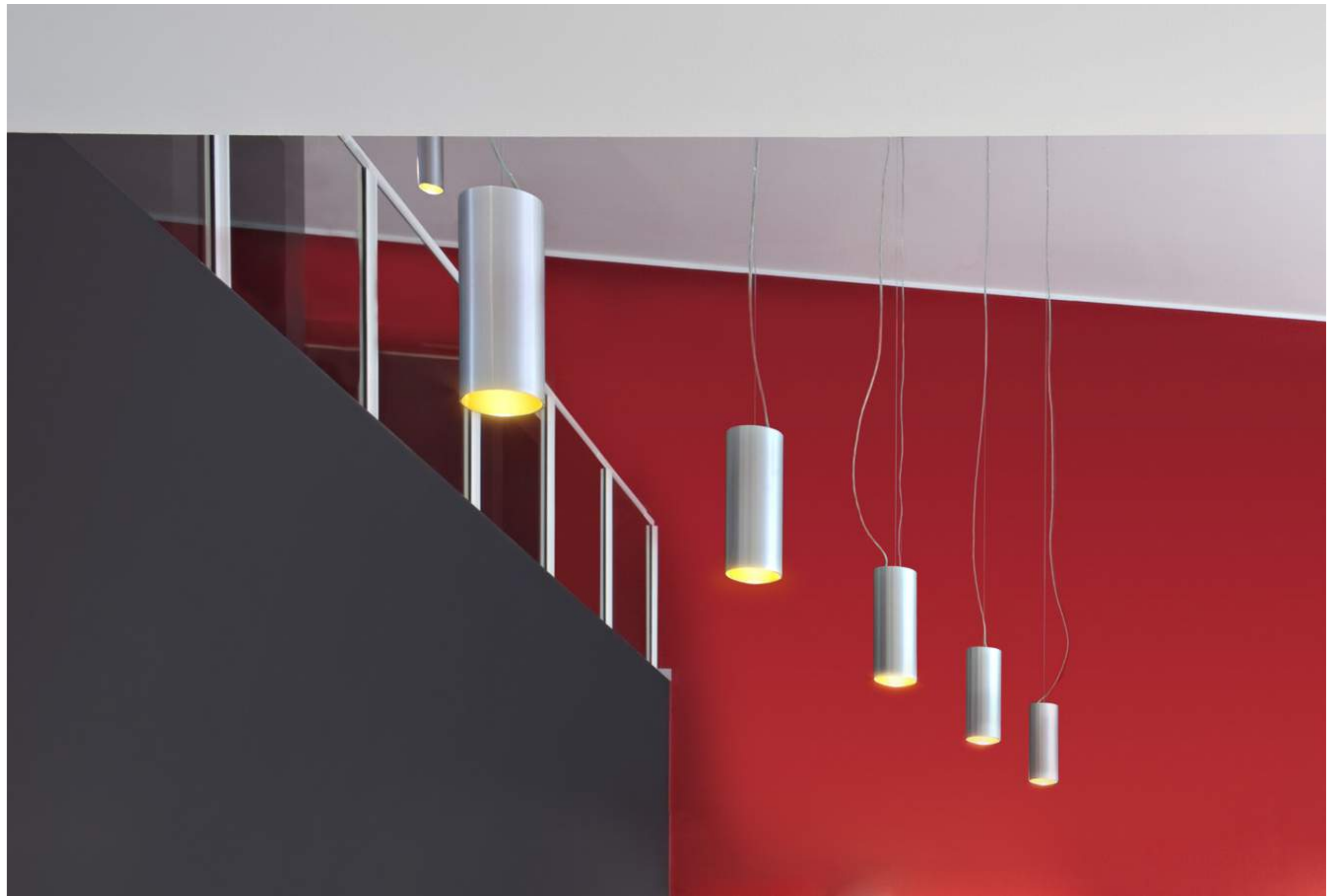

VIRGIN ACTIVE - ITALY

Colección de aparatos para satisfacer todas las exigencias luminotécnicas que pueden surgir tanto en aplicaciones residenciales como en contextos altamente profesionales especializados, tales como oficinas, áreas comerciales y áreas de acogida. Light Sniper presenta empotrables para la iluminación de acento, fijas, orientables y wall-washer. Entre las fuentes de luz disponibles, también el LED.

LIGHT SNIPER

Collection of devices to satisfy all the lumino-technical demands that might arise both in residential applications and in highly professional and specialised contexts, such as offices, shopping areas and reception areas. Light Sniper has recessed devices for accent lighting, which can be fixed, directional or wall-washers. It is available in LED as well as other light sources.





VIRGIN ACTIVE - PORTUGAL

LIGHT SNIPER

LIGHT SNIPER ROUND



Luminarias empotrables de altas prestaciones para lámparas halógenas con reflector dicróico, lámparas reflectoras de halogenuro metálico o en versión LED. Ofrecen un alto confort debido a la posición retrasada de la fuente de luz visual. Cuerpo de la luminaria realizado en dos cuerpos de aluminio inyectado. Aro frontal realizado en chapa de acero de 1 mm de espesor redondo en acabado blanco mate. Dispone de conos apantalladores realizados en inyección de zamak en tres decorados: negro, oro mate y cromo. Versiones fijas, basculantes y bañadores de pared. Lente difusora realizada en cristal templado opal en las versiones halógenas fijas y basculantes. En las versiones wall-washer incorpora lente de distribución realizada en borosilicato.

High performance recessed luminaires for halogen lamps with dichroic reflector, metal halide reflector lamps or in LED version. They offer a high comfort due to the back visual position of light source. Body of the luminaire made of two bodies of injected aluminium. Round front ring made of steel sheet 1 mm thick with white matt finish. It incorporates shielded cones made in zamak injection in three sets: black, matt gold and chrome. Fixed, tilt and wall-washers versions. Spreading lens made in opal tempered glass in halogen fixed and tilt versions. In wall-washer versions a distribution lens made of borosilicate is incorporated.

Colores Colours

06 Cromo
06 Chrome

GL Oro Mate
GL Matt Gold

14 Negro Mate
14 Matt Black



Rotación Rotation Features

Puede ser rotado 360° y orientado 40°.
Can be rotated 360° and swivelled 40°.

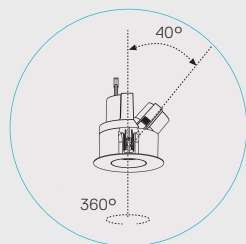

LIGHT SNIPER

FIXED



PHOSPHOR LED
13W
1000 lm
3000K/CRI 80
13,4W
700 lm
3000K/CRI 95



POWER LED
10,2W
910 lm
2700K/CRI 90
10,2W
1210 lm
3000K/CRI 80

FIXED



QR-CBC 51
GX5.3
MAX 50W
- OR -
LED QR-CBC 51
7/10W



HI PAR 51
GX10
MAX 35W

FIXED DOUBLE FOCUS



QT-12
GY6.35
MAX 50W



CDM-TM
PGJ5
MAX 35W

ADJUSTABLE



PHOSPHOR LED
8,3W
720 lm
3000K/CRI 80
9,4W
550 lm
3000K/CRI 95



POWER LED
10,2W
910 lm
2700K/CRI 90
10,2W
1210 lm
3000K/CRI 80

ADJUSTABLE



QR-CBC 51
GX5.3
MAX 50W
- OR -
LED QR-CBC 51
7/10W



HI PAR 51
GX10
MAX 35W

WALL-WASHER



POWER LED
10,2W
910 lm
2700K/CRI 90
10,2W
1210 lm
3000K/CRI 80



QR-CBC 51
GX5.3
MAX 50W



HI PAR 51
GX10
MAX 35W

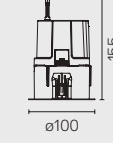
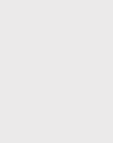
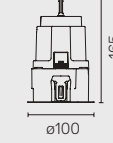
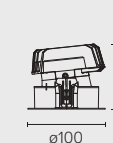
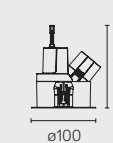
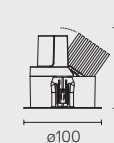
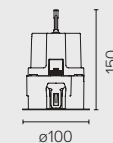
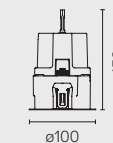
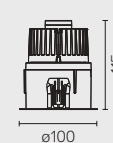

LIGHT SNIPER

LIGHT SNIPER SQUARE



Luminarias empotrables de altas prestaciones para lámparas halógenas con reflector dicróico, lámparas reflectoras de halógeno metálico y en versión LED. Ofrecen un alto confort debido a la posición retrasada de la fuente de luz visual. Cuerpo de la luminaria realizado en dos cuerpos de aluminio inyectado. Aro frontal realizado en chapa de acero de 1 mm de espesor cuadrado en acabado blanco mate. Dispone de conos apantalladores realizados en inyección de zamak en tres decorados: negro, oro mate y cromo. Versiones fijas, basculantes y bañadores de pared. Lente difusora realizada en cristal templado opal en las versiones halógenas fijas y basculantes. En las versiones wall-washer incorpora lente de distribución realizada en borosilicato.

High performance recessed luminaires for halogen lamps with dichroic reflector, metal halide reflector lamps or in LED version. They offer a high comfort due to the back visual position of light source. Body of the luminaire made of two bodies of injected aluminium. Square front ring made of steel sheet 1 mm thick with white matt finish. It incorporates shielded cones made in zamak injection in three sets: black, matt gold and chrome. Fixed, tilt and wall-washers versions. Spreading lens made in opal tempered glass in halogen fixed and tilt versions. In wall-washer versions a distribution lens made of borosilicate is incorporated.

Colores Colours

06 Cromo
06 Chrome

GL Oro Mate
GL Matt Gold

14 Negro Mate
14 Matt Black

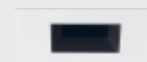

Rotación Rotation Features

Puede ser rotado 360° y orientado 40°.
Can be rotated 360° and swivelled 40°.

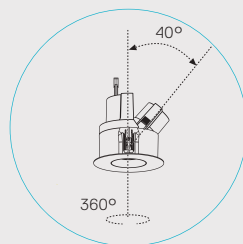

LIGHT SNIPER

FIXED



PHOSPHOR LED
13W
1000 lm
3000K/CRI 80
13,4W
700 lm
3000K/CRI 95



POWER LED
10,2W
910 lm
2700K/CRI 90
10,2W
1210 lm
3000K/CRI 80

FIXED



QR-CBC 51
GX5.3
MAX 50W
- OR -
LED QR-CBC 51
7/10W



HI PAR 51
GX10
MAX 35W

FIXED DOUBLE FOCUS



QT-12
GY6.35
MAX 50W



CDM-TM
PGJ5
MAX 35W

ADJUSTABLE



PHOSPHOR LED
8,3W
720 lm
3000K/CRI 80
9,4W
550 lm
3000K/CRI 95



POWER LED
10,2W
910 lm
2700K/CRI 90
10,2W
1210 lm
3000K/CRI 80

ADJUSTABLE



QR-CBC 51
GX5.3
MAX 50W
- OR -
LED QR-CBC 51
7/10W



HI PAR 51
GX10
MAX 35W

WALL-WASHER



POWER LED
10,2W
910 lm
2700K/CRI 90
10,2W
1210 lm
3000K/CRI 80



QR-CBC 51
GX5.3
MAX 50W



HI PAR 51
GX10
MAX 35W

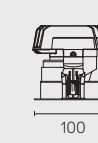
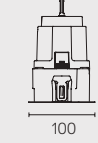
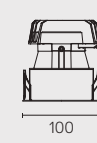
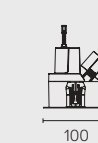

LIGHT SNIPER

LIGHT SNIPER



El cuerpo óptico se completa con un reflector que limita el deslumbramiento de la fuente de luz.

The optical body includes a reflector that reduces the glaring effect of the lamp.



El elemento apantallador de la luminaria puede estar acabado en tres decorados diferentes: negro mate, oro y cromo.

The anti-glare screen of the luminaire is available with three different colours: dull black, gold and chrome.



La luminaria incluye en su cuerpo de empotramiento un elemento radiador con el fin de controlar la correcta temperatura de trabajo de la misma.

The main body of the luminaire contains a radiator for temperature control.



Las labores de mantenimiento de la lámpara se realizan sin necesidad alguna de herramientas gracias a sus elementos de cierre a presión realizados en acero inox.

Thanks to the pressure clips made of stainless steel, it is possible to replace the lamp without using any particular tool.





302

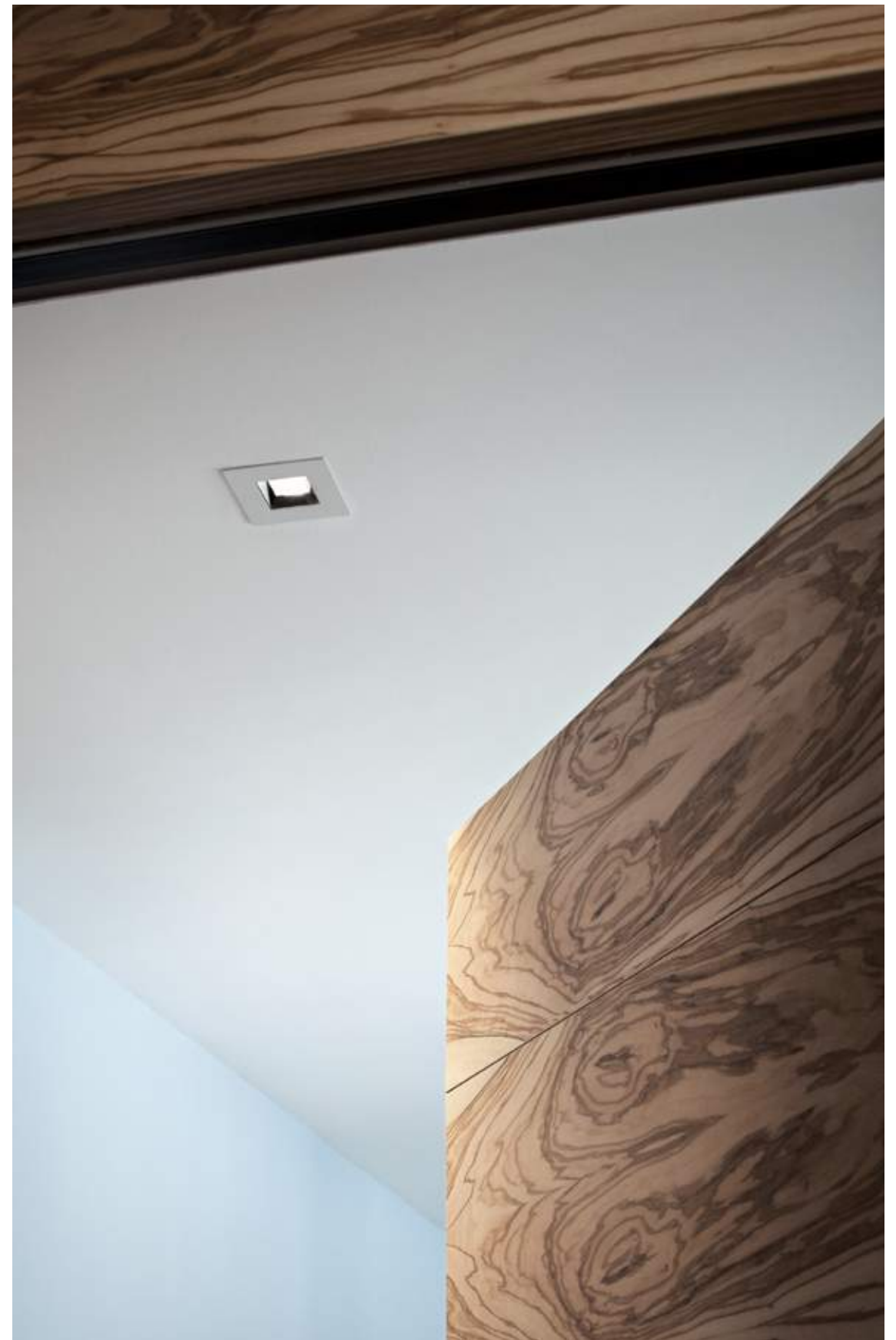

303

Familia de aparatos de iluminación orientables para instalaciones a suspensión, pared, techo y empotrados. Predispuestos para lámparas halógenas, de descarga, fluorescentes y LEDs de última generación. La gran variedad de acabados disponibles, hacen que el Compass Box destaque también como un útil complemento en la decoración.

COMPASS BOX

Family of directional lighting devices for suspension, wall, ceiling or recessed mounting. Ready for halogen, discharge, fluorescent and latest generation LED lamps. Due to the great variety of finishes available, the Compass Box also stands out as a useful decoration accessory.





COMPASS BOX SURFACE



Sistema de iluminación de uno, dos y cuatro focos orientables para ser instalados a pared o a techo.
Preparado para fuentes de iluminación halógena a baja tensión, halogenuro metálico y LED Array.
Cuerpo óptico en acero estampado pintado con pintura negra y estructura exterior realizada en extrusión de aluminio con sistema de fijación a techo.
Conexión eléctrica y equipos de control incorporados en la luminaria.

Wall/ceiling luminaires with 1, 2 or 4 adjustable lights.
Prepared for low-voltage halogen light sources, metal-halide source and LED array.
Pressed steel, black-painted optical body and extruded-aluminum outer structure with fixing system.
Electrical connection and control devices incorporated in the luminaire.

Colores
Colours

30 Blanco Mate
30 Matt White



14 Negro Mate
14 Matt Black



29 Aluminio Anodizado
29 Anodized Aluminium



WG Wenge
WG Wenge



TK Teca
TK Teak



Rotación
Rotation Features

Puede ser orientado 20°.
Can be swivelled 20°.

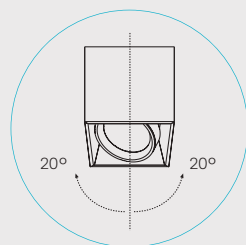

COMPASS BOX SURFACE

SMALL
1L / 2L / 4L /
4L SQUARE



LED ARRAY
7W
660 1m
3000K
CRI 80

SMALL
1L / 2L / 4L



QR-CBC 51
GX5.3
MAX 35W
- OR -
LED QR-CBC 51
7/10W

LARGE H:135
1L / 2L / 4L /
4L SQUARE

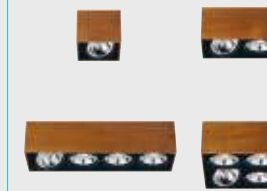

QR-111
G53
MAX 75W
- OR -
LED QR-111

LARGE H:160
1L / 2L / 4L /
4L SQUARE

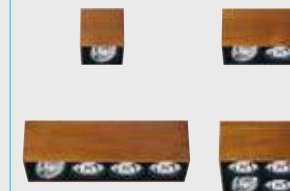

CDM-R111
GX8.5
35/70W

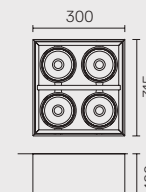
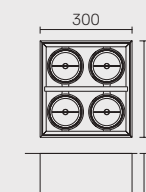
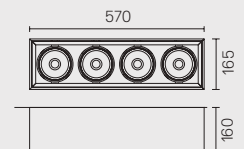
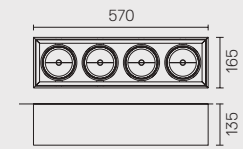
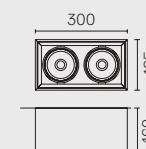
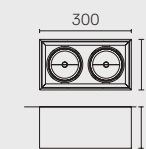
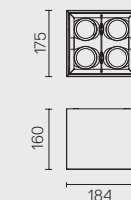
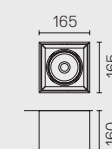
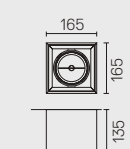
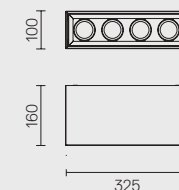
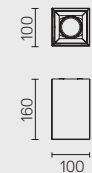

COMPASS BOX SURFACE

COMPASS BOX SURFACE





PRIVATE KITCHEN - U.S.A.

COMPASS BOX T5 / T5 SUSPENSION

COMPASS BOX T5
+ SPOTS



Luminaria de iluminación directa para lámparas fluorescentes lineales.
Estructura exterior realizada en extrusión de aluminio con sistema de fijación a techo. Disponible con reflector de policarbonato metalizado o difusor microprismado para la iluminación directa. Conexión eléctrica y equipos de control incorporados en la luminaria.

Luminaire for direct lighting available for fluorescent linear lamps.
Exterior structure made of extruded aluminium with ceiling fixing system. Available with metallic polycarbonate reflector or microprismed diffuser for direct lighting. The luminaire incorporates power supply and control devices.

COMPASS BOX T5 SUSPENSION
+ SPOTS



Luminaria de iluminación directa e indirecta para lámparas fluorescentes lineales.
Estructura exterior realizada en extrusión de aluminio con sistema de fijación a techo mediante cables de suspensión ajustables. Disponible con reflector de policarbonato metalizado o difusor microprismado para la iluminación directa. Difusor de policarbonato opal para luz indirecta. Conexión eléctrica y equipos de control incorporados en la luminaria. Dispone de rosetón de alimentación con cubierta de policarbonato transparente.

Luminaire for direct and indirect lighting available for fluorescent linear lamps.
Exterior structure made of extruded aluminium with ceiling fixing system through adjustable suspension cables. Available with metallic polycarbonate reflector or microprismed diffuser for direct lighting. Opal polycarbonate diffuser for indirect lighting. The luminaire incorporates power supply and control devices. It has a power socket with a transparent polycarbonate cover.

- Colores / Colours
- 30 Blanco Mate
30 Matt White
 - 14 Negro Mate
14 Matt Black
 - 29 Aluminio Anodizado
29 Anodized Aluminium



COMPASS BOX T5 / T5 SUSPENSION

COMPASS BOX T5
+ SPOTS



T5 FH/FQ
G5
28W-FH
54W-FQ

COMPASS BOX T5
SUSPENSION + SPOTS



QR-CBC 51
GX5.3
MAX 4x35W
- OR -
LED QR-CBC 51
7/10W

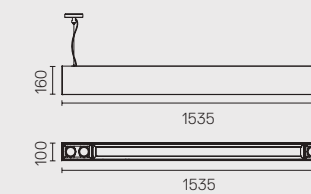
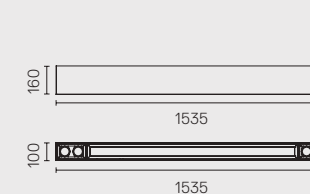



Elemento de apantallamiento de la fuente luminosa realizado en aluminio de gran calidad acabado en anodizado brillo.

Anti-glare screen made of high quality aluminium with glossy anodized finish.



Cristal difusor para distribuciones uniformes en planos de trabajo horizontales.

Glass diffuser for an even light output on horizontal work surfaces.



La luminaria prevé la posibilidad de incluir luz indirecta en su parte superior.

The luminaire offers the possibility to add an indirect light in the upper part.



La luminaria prevé la posibilidad de iluminación de acento gracias a una pareja de proyectores integrados en el cuerpo principal.

The luminaire can be integrated with a couple of spots that allow to add accent light.





PRIVATE HOUSE - ITALY

COMPASS BOX RECESSED



Diseñado para lámparas LED, halógenas de muy baja tensión o directas a red, de halogenuros metálicos o fluorescencia. Para empotrar en falsos techos de hasta 30mm de espesor. Sistema de 1, 2 ó 4 luminarias orientables. Cuerpo para empotrar de acero pintado con barniz en polvo y marco para empotrar realizado de extrusión de aluminio con sistema de fijación al falso techo. Para las versiones halógenas y de halogenuro metálico, sistema de orientación tipo "compás" de acero pintado con barniz en polvo de color negro opaco. Sistema de fijación mediante soportes de acero pintado negro atornillados. Regleta para las conexiones eléctricas situada por encima de la caja que aloja las lámparas.

Designed for LED lamps, very low voltage halogen lamps or direct mains power, metal halide or fluorescent lamps. For recess mounting in suspended ceilings of up to 30mm thick. 1, 2, or 4 lamp adjustable- system. Pressed steel powder-coated recessed housing, extruded aluminum recessed trim frame for use with false ceiling systems. Steel "compass-type" adjustment mechanism, powder-coated matt black. For halogen and discharge versions: Innovative steel bracket fixing system, painted black, with allen key locking mechanism. Terminal block positioned on canopy housing box.

Colores
Colours

30 Blanco Mate
30 Matt White

14 Negro Mate
14 Matt Black



Rotación
Rotation Features

Puede ser orientado 20°.
Can be swivelled 20°.

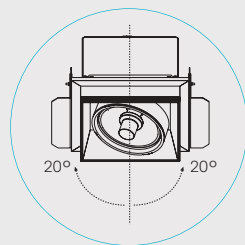

COMPASS BOX RECESSED

SMALL 1L / 2L



LED ARRAY
10,5W
930 lm
3000K
CRI 80

SMALL 1L / 2L



QR-CBC 51
GX5.3
MAX 50W
- OR -
LED QR-CBC 51
7/10W

LARGE 1L / 2L





QR-111
G53
MAX 100W
- OR -
LED QR-111

CDM-R111
GX8.5
MAX 70W

FLUO LARGE
2L / 4L SQUARE / 2L

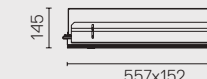
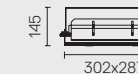
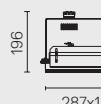
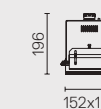
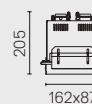
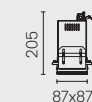

TC-L
2G11
18/40W



COMPASS BOX RECESSED

COMPASS BOX RECESSED



El sistema de orientación tipo "compás" realizado en acero permite la orientación de la luminaria en cualquier dirección sin apreciar los ejes de rotación. Cuerpo óptico empotrado para disminuir el deslumbramiento de la propia luminaria.

The compass adjustment system made of steel allows the adjustment of the lamp in any directions and on any rotation axes. Recessed optical body which reduces the glaring effect of the lamp.



Familia de aparatos de iluminación empotrables, disponibles en módulos de diversas dimensiones, Trim y No Trim, que representan soluciones integradas en el ambiente para una iluminación de acento eficaz y versátil.

BATTERY

Family of recessed lighting devices, offered in different-sized modules, Trim and Non-Trim, becoming a solution that is integrated into the environment to provide efficient and versatile accent lighting.





BATTERY TRIM



Sistema de 1, 2, 3 ó 4 luminarias orientables, para empotrar en falsos techos de 1 a 30mm de espesor. Diseñado para lámparas LED, halógenas de muy baja tensión o directas a red y de halogenuros metálicos, combinables entre ellas. Cuerpo para empotrar de acero inyectado y pintado con barniz en polvo de color negro opaco. Sistema de orientación tipo "compás" de acero inyectado y pintado con barniz en polvo de color negro opaco. Sistema de fijación mediante soportes de acero pintado negro atornillados. Aros moleteados en aluminio inyectado a presión alojados en un marco de acero de 3mm. Regleta para las conexiones eléctricas situada por encima de la caja que aloja las lámparas. En las versiones con lámparas halógenas: aro interior adicional de PPS de alta resistencia para la fijación de la lámpara y antideslumbramiento. En las versiones con lámparas de descarga: disipador térmico, situado sobre el portalámparas, en aleación de aluminio inyectado a presión. Cristal de protección templado de 3mm de espesor.

1, 2, 3 or 4 lamp adjustable- system, for recessed ceiling thicknesses of 1-30mm. Suitable for use with LED lamps, main voltage and metal halide lamps which can be used in a variety of combinations. Pressed steel and matt black, powder-coated recessed housing. Steel "compass-type" adjustment mechanism, powder-coated matt black. Innovative steel bracket fixing system, painted black, with allen key locking mechanism. Die-cast aluminum knurled rings housed in a 3mm steel frame. Terminal block positioned on canopy housing box. Halogen: additional high-resistance PPS inner ring, for mounting lamp and anti-glare functions. Discharge: die-cast aluminum alloy heat sink positioned above the lamp support, 3mm tempered glass cover.

- Colores**
Colours
- 20 Blanco Mate
20 Matt White
 - 08 Mercurio
08 Mercury
 - 14 Negro Mate
14 Matt Black



Rotación
Rotation Features

Puede ser rotado 40° en cualquier dirección.
Can be rotated 40° in any direction.

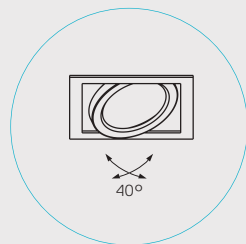

BATTERY TRIM

BATTERY TRIM SMALL



LED ARRAY
20W
2290 1m
3000K
CRI 80

BATTERY TRIM SMALL



QR-CBC 51
GX5.3
MAX 50W
- OR -
LED QR-CBC 51
7/10W

QR-70
BA15d
MAX 50W

BATTERY TRIM LARGE



QR-111
G53
MAX 100W
- OR -
LED QR-111

HIT-CRI
G12
MAX 70W

CDM-TC
G8.5
MAX 70W
CDM-R111
GX8.5
MAX 70W

LED ARRAY

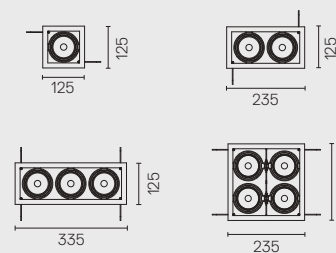

QR-CBC 51

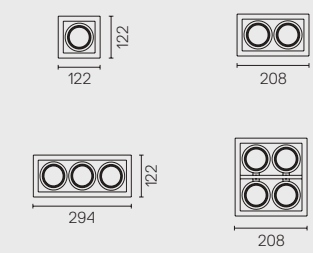

QR-111

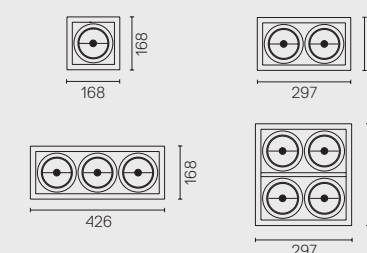

QR-70

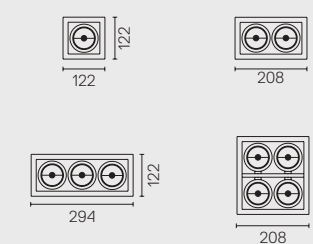

CDM-TC / HIT-CRI

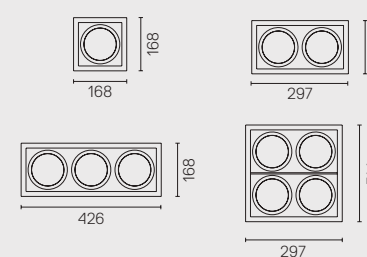

CDM-R111

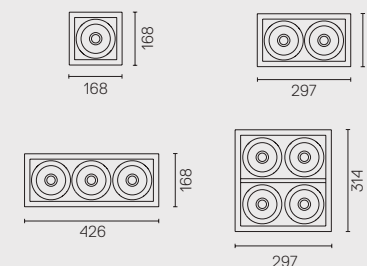

BATTERY NO TRIM



Sistema de 1, 2, 3 ó 4 luminarias orientables, para empotrar en falsos techos de 1 a 30mm de espesor. Diseñado para lámparas LED, halógenas de muy baja tensión o directas a red, de halogenuros metálicos, combinables entre ellas. Cuerpo para empotrar de acero inyectado y pintado con barniz en polvo de color negro opaco y marco para empotrar realizado de extrusión de aluminio con sistema de fijación al falso techo. Sistema de orientación tipo "compás" de acero y pintado con barniz en polvo de color negro opaco. Sistema de fijación mediante soportes de acero pintado negro atornillados. Aros moleteados en aluminio inyectado a presión. Regleta para las conexiones eléctricas situada por encima de la caja que aloja las lámparas. En las versiones con lámparas halógenas: aro interior adicional de PPS de alta resistencia para la fijación de la lámpara y antideslumbramiento. En las versiones con lámparas de descarga: disipador térmico, situado sobre el portalámparas, en aleación de aluminio inyectado a presión. Cristal de protección templado de 3mm de espesor.

1, 2, 3 or 4 lamp adjustable- system, for recessed ceiling thicknesses of 1-30mm. Suitable for use with LED lamps, very low voltage halogens or direct mains power, metal halide lamps or a combination of them. Pressed steel and matt black, powder-coated recessed housing, extruded aluminum recessed trim frame for use with false ceiling systems. Steel "compass-type" adjustment mechanism, powder-coated matt black. Innovative steel bracket fixing system, painted black, with allen key locking mechanism. Die-cast aluminum knurled rings. Terminal block positioned on canopy housing box. Halogen: additional high-resistance PPS inner ring, for mounting lamp and anti-glare functions. Discharge: die-cast aluminum alloy heat sink positioned above the lamp support, 3mm tempered glass cover.

Colores
Colours

<input type="checkbox"/> 20 Blanco Mate	<input type="checkbox"/> 08 Mercurio	<input type="checkbox"/> 14 Negro Mate
20 Matt White	08 Mercury	14 Matt Black



Rotación
Rotation Features

Puede ser rotado 40° en cualquier dirección.
Can be rotated 40° in any direction.

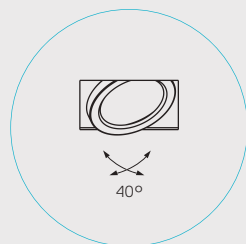

BATTERY NO TRIM

BATTERY NO TRIM SMALL

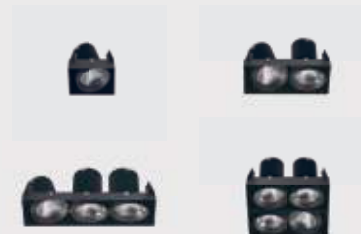

LED ARRAY
20W
2290 1m
3000K
CRI 80

BATTERY NO TRIM SMALL

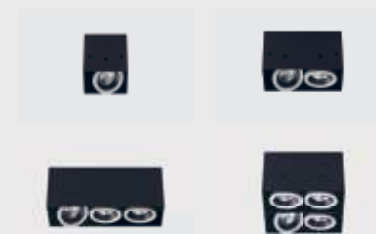



QR-CBC 51
GX5.3
MAX 50W
- OR -
LED QR-CBC 51
7/10W

QR-70
BA15d
MAX 50W

BATTERY NO TRIM LARGE





QR-111
G53
MAX 100W
- OR -
LED QR-111

CDM-TC
G8.5
MAX 70W

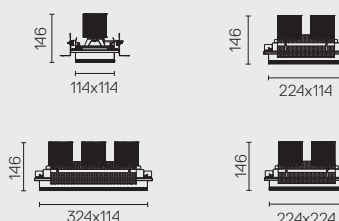

HIT-CRI
G12
MAX 70W

CDM-R111
GX8.5
MAX 70W

LED ARRAY

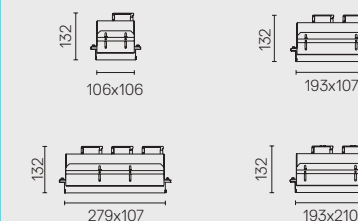

QR-CBC 51 / QR-70



QR-111

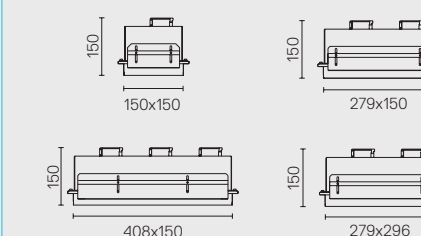

CDM-TC / HIT-CRI

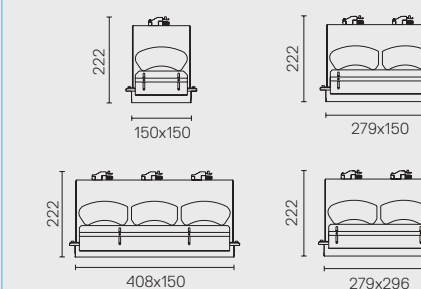

CDM-R111

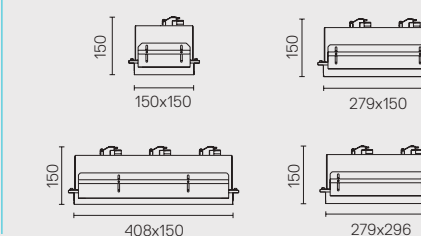

BATTERY

BATTERY

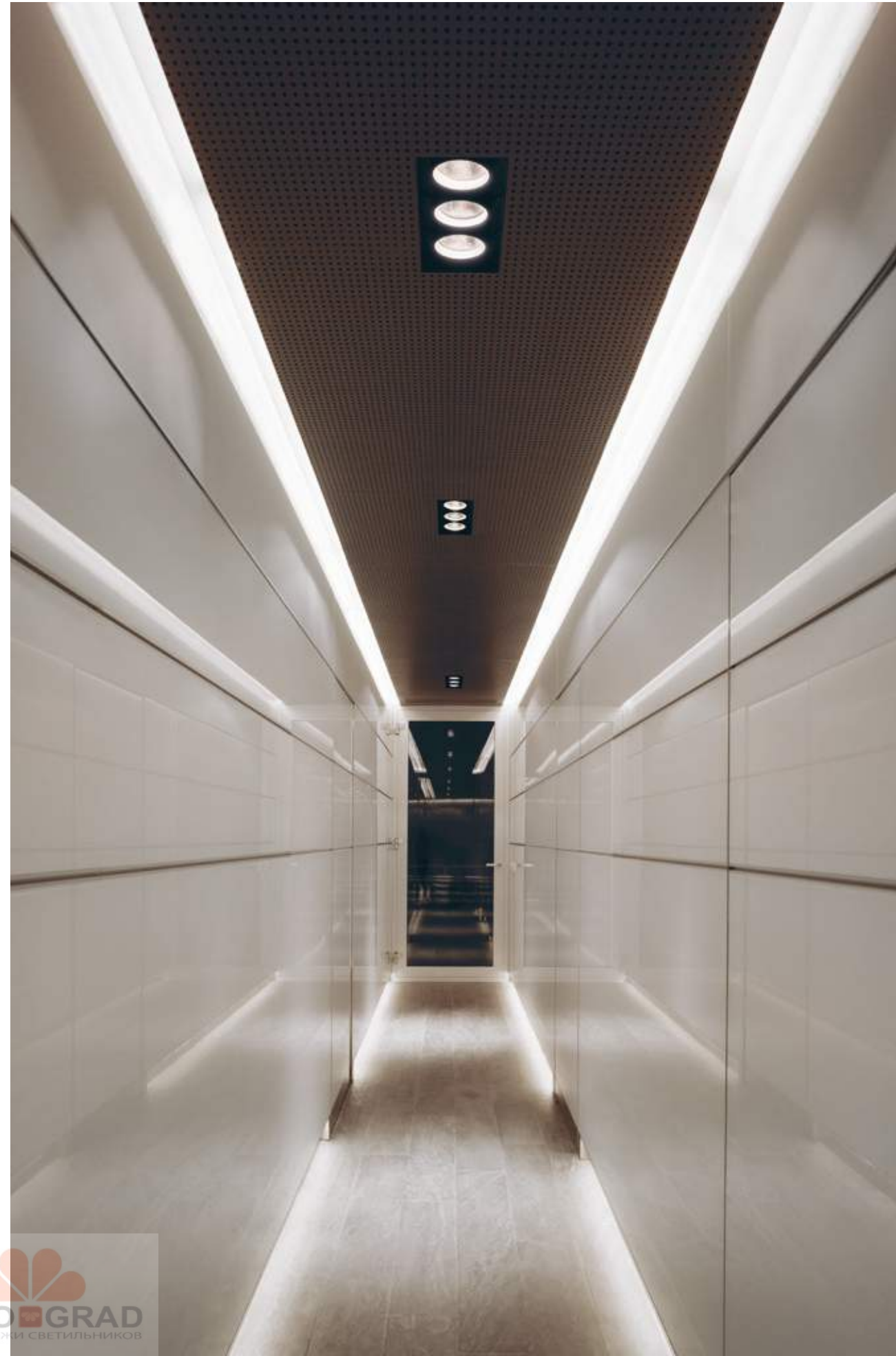
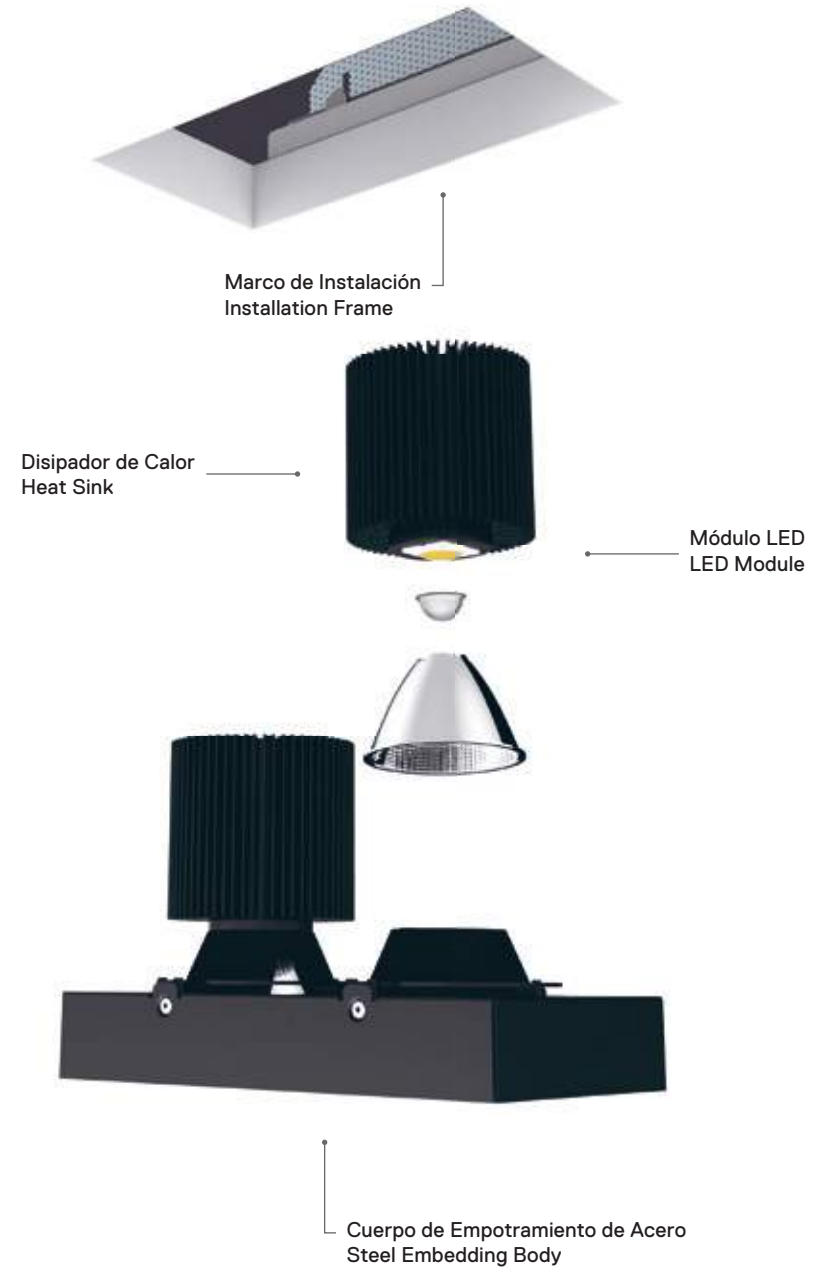





VIRGIN ACTIVE - ITALY

MICRO BATTERY



Luminaria para empotrar para ser instalada en interiores, en las versiones orientable o fija.
 Diseñada para lámparas LED, halógenas de muy baja tensión o directas a red. Cuerpo inclinable de soporte de la lámpara de aluminio inyectado a presión y acabado pintado negro con barniz en polvo. Anillo de cierre inyectado a presión acabado pintado negro con barniz en polvo. Muelle de fijación de la lámpara de acero inoxidable. Cuerpo para empotrar, de protección de la lámpara, de acero y acabado en pintura negra con barniz en polvo. Marco exterior de aluminio acabado en pintura. Sistema de fijación previsto para falsos techos de hasta 30mm de espesor con soportes de acero inoxidable provistos de tornillos de seguridad.

Recessed indoor luminaire, adjustable or fixed. Suitable for use with LED lamps, very low voltage halogens or direct mains power, metal halide lamps or a combination of them. Die-cast aluminum adjustable lamp-support with black powder-coated finish. Die-cast aluminum, black powder-coated closing ring. Stainless steel lamp fixing spring. Recessed steel body for reducing lamp visibility with black powder-coated finish. Painted aluminum outer frame. Fixing system for ceiling thicknesses 0-30mm. with steel sprung brackets.

- Colores**
Colours
- 20 Blanco Mate
 20 Matt White
 - 08 Mercurio
 08 Mercury
 - 14 Negro Mate
 14 Matt Black



Rotación
Rotation Features

La versión basculante puede ser orientada 40° en cualquier dirección.
 Adjustable versions can be swivelled 40° in any direction.

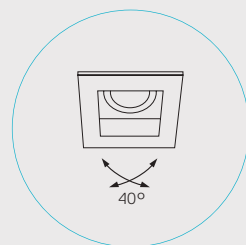

MICRO BATTERY

FIXED

ADJUSTABLE

FIXED

ADJUSTABLE



ASYMMETRIC
1L

ASYMMETRIC
2L

ASYMMETRIC
1L

ASYMMETRIC
2L



LED ARRAY
 10,5W
 930 lm
 3000K
 CRI 80



PAR 16
 GZ10
 MAX 50W
 - OR -
LED PAR 16
 4W



QR-CBC 51
 GX5.3
 MAX 50W
 - OR -
LED QR-CBC 51
 7/10W





Luminaria No Trim para empotrar en techo. Dispone de 4 Power LED con tecnología Step Down para alimentación en 24V. El control de la luz se realiza mediante lentes optimizadas para una perfecta distribución luminosa. El producto incorpora en cada uno de los LEDs un pipe decorativo disponible en tres colores: transparente, naranja y violeta. Para elevar el confort visual de la luminaria es posible incorporar cilindros apantalladores.

LED PIPES

Ceiling-mounted recessed No Trim luminaire. It has 4 Power LEDs with Step Down technology for 24V power supply. The light is controlled by optimised lenses for perfect light distribution. Each one of the LEDs incorporates a decorative pipe in three colours: transparent, orange and violet. Cut-off pipes can be incorporated to increase the visual comfort of the luminaire.





PRIVATE HALL ENTRANCE - BELGIUM

LED PIPES



Luminaria para empotrar a techo, sin marco. Se compone de un cuerpo de plástico que se empotra en una caja de instalación, en la que sobresalen cilindros decorativos disponibles en 3 decorados: transparente, naranja y violeta. Cada uno de estos cilindros incorpora un Power LED de 3000K con una reproducción cromática CRI 80.

Frameless light fixture for ceiling mounting formed by a plastic body embedded in a mounting box wherein decorative cylinders are visible, available in 3 colours: transparent, amber and violet. Each cylinder has a power LED of 3000K with a chromatic CRI 80 reproduction.

Colores
Colours

□ 30 Blanco
30 White

■ 14 Negro
14 Black



Colores del Pipe
Pipe Colours

Transparente
Transparent

■ Naranja
Orange

■ Violeta
Violet



Colores del Cilindro Apantallador
Screening Cylinder Colours

□ Blanco
White

■ Negro
Black



Los diferentes acabados del cuerpo principal de la luminaria (blanco y negro) se combinan con diferentes decorados del cuerpo óptico (transparente, naranja y violeta).

The different colours of the luminaire main body (white and black) suit the different decorations of the optical body (transparent, orange and violet).

LED PIPES



POWER LED
10W
850 lm
3000K
CRI 80

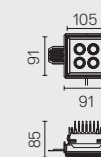

LED PIPES

LED PIPES

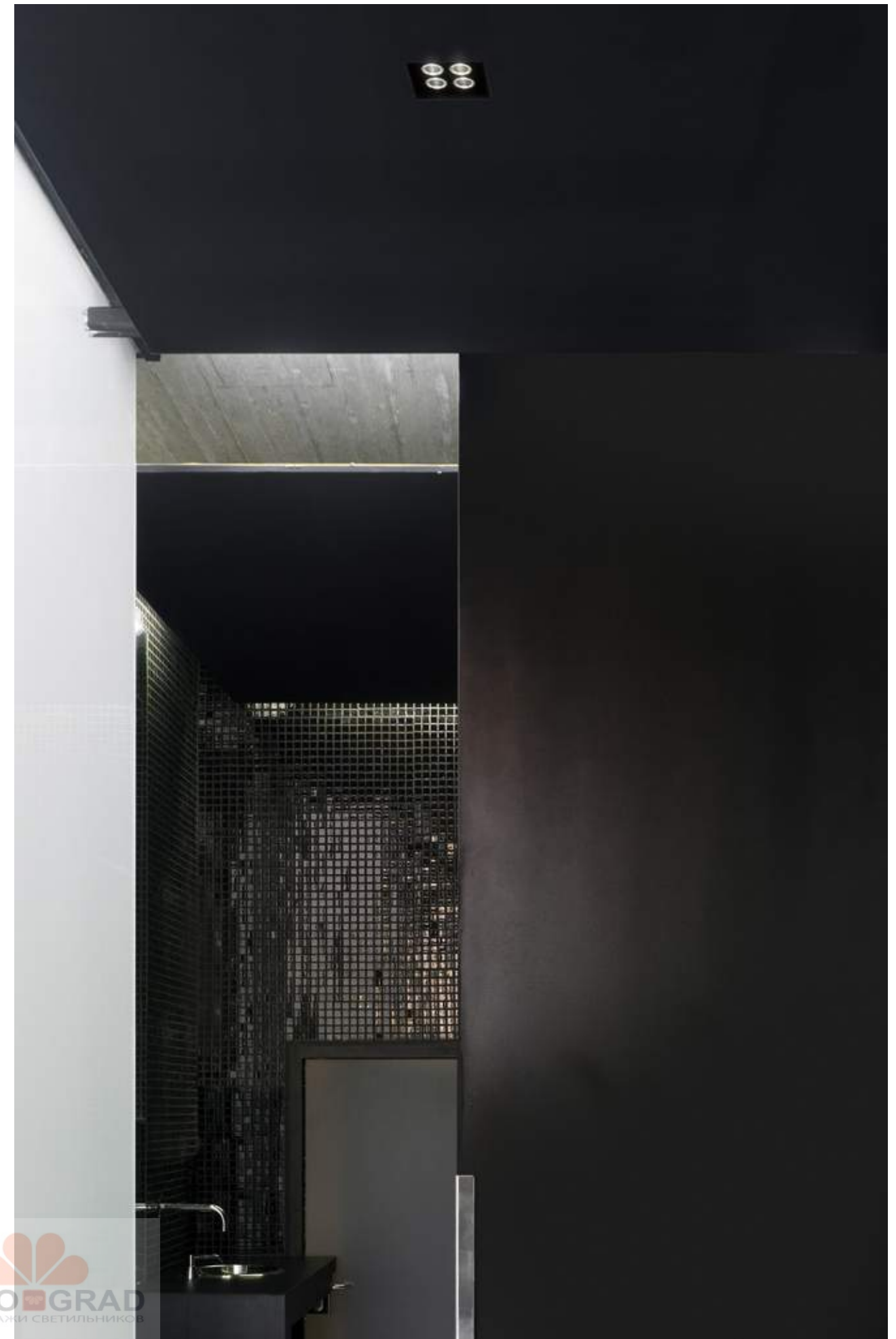
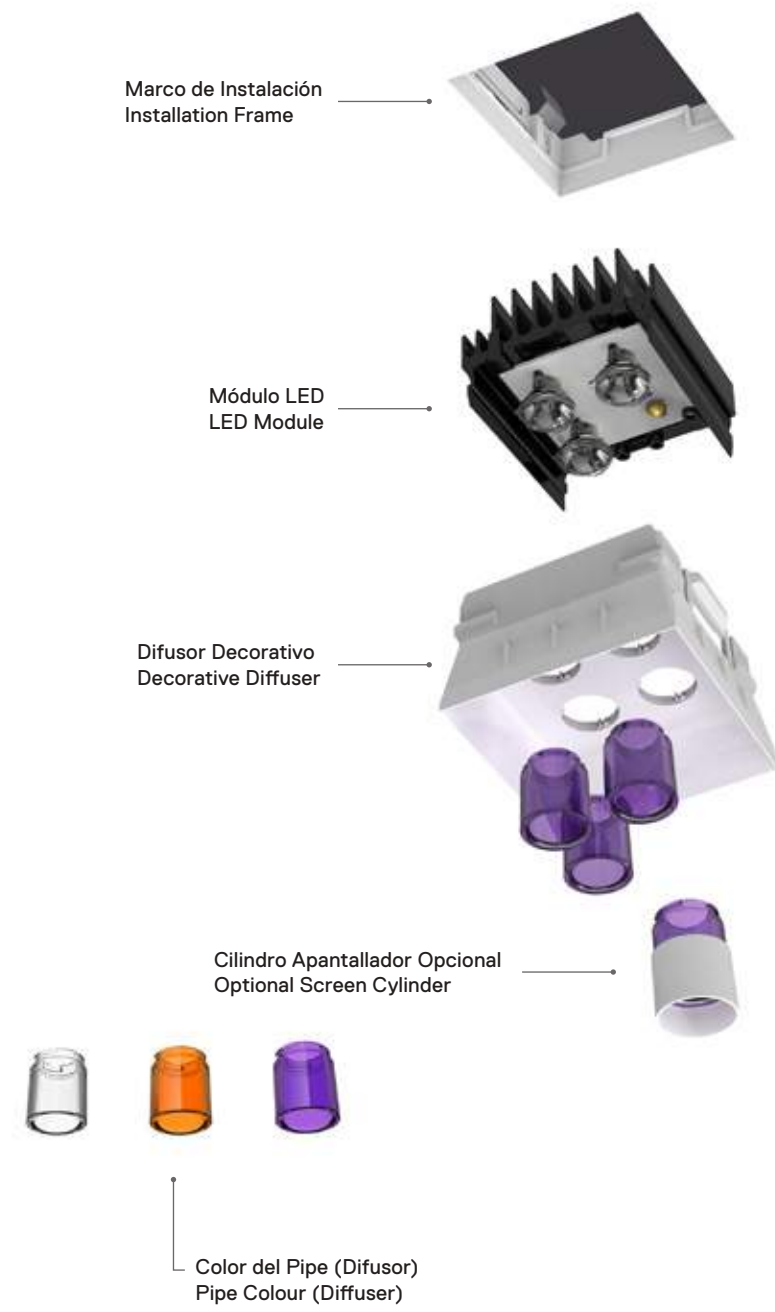

Familia de luminarias empotrables con fuente de luz LED. Dicha fuente de luz ofrece un gran confort visual al tener una posición retrasada. La familia Decofix está disponible con una o dos luces, y en versión cuadrada y circular.

DECOFIX

Family of recessed luminaires with LED light source. The delayed position of this light source results in great visual comfort. The Decofix family is available with one or two lights in square and circular versions.





352

353

DECOFIX

DECOFIX ROUND 2 L



DECOFIX SQUARE 2 L



Luminarias empotrables fijas de 1 y 2 luces, para fuente de iluminación LED. Ofrecen un alto confort visual debido a la posición retrasada de la fuente de luz. Disponibles en versiones cuadradas y redondas en acabado blanco y negro mate. Se componen de un cuerpo realizado en aluminio y muelles de sujeción a techo. Disponen de un radiador para cada LED realizado en aluminio inyectado.

Fixed embedded light fixtures with 1 and 2 lights, for LED light source. Great visual comfort due to rear position of light source. Available in square and round versions in a matt white and black finish. They are made up of a body made in aluminium and fixing springs to the ceiling. They have a radiator for each LED made out of injected aluminium.

Colores
Colours

30 Blanco
30 White

14 Negro
14 Black



Colores del Cilindro Apantallador
Screening Cylinder Colours

Plata
Silver

Oro
Gold

Negro
Black

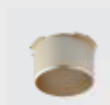

DECOFIX

DECOFIX
ROUND 1L



DECOFIX
ROUND 2L



DECOFIX
SQUARE 1L



DECOFIX
SQUARE 2L



LED ARRAY
10,5W
720 1m
2700K/CRI 90
10,5W
930 1m
3000K/CRI 80

Decofix
Round 1L

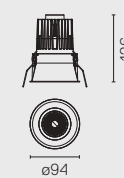

Decofix
Round 2L

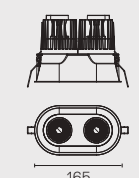

Decofix
Square 1L

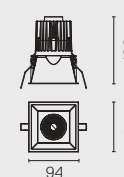

Decofix
Square 2L

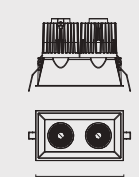



Fuente de luz retrasada que ofrece un gran confort visual.

Delayed light source that offers great visual comfort.

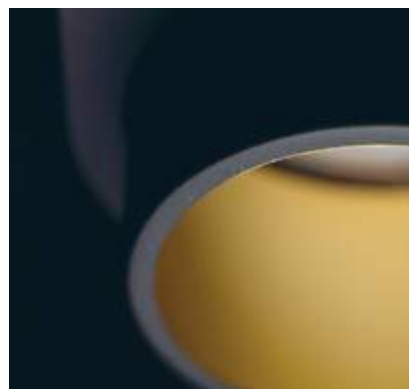

Cilindro apantallador disponible en tres acabados: negro, oro o plata, intercambiables entre sí.

Cut-off pipe available in three finishes: black, gold or silver, that are interchangeable.





PRIVATE HOUSE - SPAIN

Familie mit Leuchten, deren Form durch die japanische Kultur inspiriert wurde: das Wort “wan” bedeutet Tasse in ihrer Funktion als “Lebensbehälter”. Zwei Ausführungen verfügbar: Die Strahlerausführung mit Sondersystem zur Lichtstrahlausrichtung und die Einbauausführung. Mit Halogen- oder Halogen-Metall dampflampen für die unterschiedlichsten Anwendungen im Wohn- und im Geschäftsbereich. Auch mit den neuen LED-Lampen erhältlich.

WAN

Famille d'appareils d'éclairage dont la forme est inspirée de la culture japonaise: “wan” signifie bol, dans sa fonction de “contenant de la vie”. Deux versions : une version spot, équipée d'un système spécial d'orientation du faisceau lumineux, et une version à encastrer. Disponibles avec lampes halogènes ou à halogénures métalliques pour s'adapter aux diverses situations qu'il s'agisse d'un environnement résidentiel ou professionnel. Également disponibles avec les nouvelles lampes LED.



DESIGNED BY JOHANNA GRAWUNDER



PRIVATE HOUSE - ITALY

WAN

WAN SPOT



WAN DOWNLIGHT



Luminaria de luz directa para ser instalada a techo o pared. Cuerpo de aluminio disponible en acabado pulido, blanco brillante, verde esmaltado y negro brillante. Incorpora como antideslumbramiento. El producto lleva incorporados dos aros interiores intercambiables, que sujetan el cristal templado y el reflector, en negro brillante o verde esmaltado.

Wall or ceiling lamp providing direct light. Aluminum body, available in chrome, shiny white, enameled green, and shiny black finishes. Low glare shield. Provided by two different ring due to fix the safety tempered glass, in shiny black and enameled green.

Luminaria de luz directa para ser instalada empotrada a techo. Aro de aluminio disponible en acabado pulido, blanco brillante, verde esmaltado y negro brillante. Incorpora como antideslumbramiento. El producto lleva incorporados dos aros interiores intercambiables, que sujetan el cristal templado y el reflector, en acabado negro brillante o verde esmaltado.

Ceiling recessed luminary providing direct light. Aluminum ring, available in chrome, shiny white, enameled green, and shiny black finishes. Low glare shield. Provided by two different ring due to fix the safety tempered glass, in shiny black and enameled green.

Colores
Colours

- 30 Blanco
30 White
- 05 Aluminio Pulido
05 Polished Aluminium
- 14 Negro
14 Black
- GN Verde
GN Green

Wan Spot



Wan Downlight

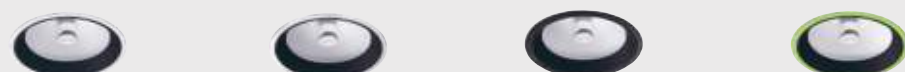

Rotación
Rotation Features

Puede ser rotado 360° y orientado 60°.
Can be rotated 360° and swivelled 60°.

Wan Spot

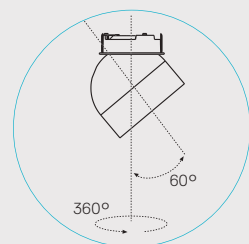

WAN

WAN SPOT



LED ARRAY
10,5W
930 1m
3000K
CRI 80

QT-14
G9
MAX 40W

QT-12
GY6.35
MAX 50W

CDM-TM
PGJ5
MAX 35W



WAN DOWNLIGHT





LED ARRAY
10,5W
930 1m
3000K
CRI 80

QT-14
G9
MAX 40W

QT-12
GY6.35
MAX 50W

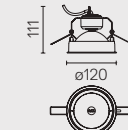
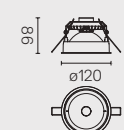
CDM-TM
PGJ5
MAX 35W



WAN



El cuerpo óptico de la luminaria incorpora un elemento cónico con el fin de limitar el deslumbramiento por visión directa de la fuente de luz.

The optical body of the luminaire is provided with a conical element which reduces the glaring effect, in the case that someone looks directly at the light source.



Fácil instalación y desinstalación de la luminaria sin necesidad de herramientas especiales. Las operaciones de cambio de lámpara se realizan a través de cierres en bayoneta.

Luminaire installation and removal without using any special tool. All operations needed for replacing a bulb are carried out with a bayonet hinge.



Sistema de orientación del haz de luz integrado en el propio cuerpo principal de la luminaria.

The light beam adjustment system is integrated in the main body of the luminaire.

WAN SPOT





PRIVATE HOUSE - ITALY

PRIVATE HOUSE - U.K.

Downlights de iluminación LED para instalación empotrada. La familia Light Soldier incorpora LED Array de alta eficiencia en combinación con reflectores de termoplástico técnico metalizados en tres ángulos de apertura, que ofrecen una perfecta uniformidad en el haz de luz. Esto y su capacidad de orientación hacen del Light Soldier una perfecta solución para los espacios de iluminación más exigentes.

LIGHT SOLDIER

LED lighting downlights for recessed mounting. The Light Soldier family incorporates high-efficiency LED Array combined with metallic technical thermoplastic reflectors in three opening angles, offering a perfectly uniform light beam. This and its directionality make The Light Soldier a perfect solution for more demanding lighting spaces.





VERDURA GOLF & SPA RESORT - ITALY

LIGHT SOLDIER

FIXED Ø75



ADJUSTABLE Ø90



Luminarias empotrables para fuente de luz LED disponibles en versión fija o basculante. Se componen de un aro frontal redondo realizado en aluminio junto a un anillo de material termoplástico negro que ofrece un alto confort visual.

Embedded light fixtures for LED light source available in fixed or tilt versions. Comprised of a round hoop at the front made of aluminium, next to a ring made of black thermoplastic material, giving great visual comfort.

Colores
Colours

□ 30 Blanco
30 White

■ 02 Gris
02 Grey

■ 14 Negro
14 Black



Rotación
Rotation Features

Puede ser rotado 360° y orientado 30°.
Can be rotated 360° and swivelled 30°.

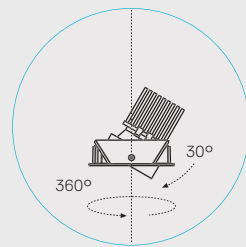

LIGHT SOLDIER

FIXED Ø75



ADJUSTABLE Ø90



LED ARRAY
10,5W
930 lm
3000K
CRI 80

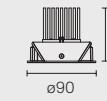
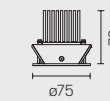

LIGHT SOLDIER



Disponible en versión fija y en versión basculante con rotación 360° y orientación 30°.

Available in fixed version and in tilting version rotated at 360° and directional at 30°.

LIGHT SOLDIER



Downtown es un programa de luminarias empotradas disponible para lámparas de halogenuros metálicos así como lámparas compactas de fluorescencia. Las diferentes ópticas han sido diseñadas para garantizar un perfecto equilibrio entre un control del deslumbramiento y un máximo rendimiento. Gracias a un innovador sistema de fijación (Downtown Trim) puede ser instalado y desinstalado sin necesidad de herramientas.

DOWNTOWN

Downtown is a programme of recessed luminaires available for metal halide and compact fluorescent lamps. The different optics have been designed to guarantee a perfect balance between glare control and maximum performance. Tool-free installation and removal thanks to an innovating fixture system (Downtown Trim).





DOWN TOWN

DOWN TOWN TRIM



DOWN TOWN NO TRIM



Luminarias empotrables para ser instaladas en interiores con lámparas fluorescentes compactas. Cuerpo óptico realizado en aluminio inyectado a presión con acabado en pintura polvo. Disipador térmico realizado en aluminio inyectado a presión unido al cuerpo de la luminaria. Dispone de reflectores inferior y superior realizados en aluminio anodizado en acabado especular. Reflector superior fijo. El reflector inferior se compone del propio reflector más un cristal difusor de 4mm de espesor y un aro de policarbonato que fija el reflector al aro de aluminio del producto. Pinzas de sujeción a techo en las versiones Trim que facilitan la instalación, realizadas en termoplástico. Disponible en dos diámetros 160mm y 215mm y en versiones Trim y No Trim.

Flush luminaires to be installed indoors with compact fluorescent lamps. Optical body made in injected aluminium with powder-coated paint finish. Heatsink made in injected aluminium under pressure attached to the body of the luminaire. Lower and upper reflectors available made of anodized aluminium with specular finish. Fixed upper reflector. Inferior reflector formed by self reflector and a spreading lens of 4mm thick and a polycarbonate ring that fixes the reflector to the aluminium ring of the product. Fastening pliers to ceiling in the easy to install Trim versions made of thermoplastic. Available in two diameters 160mm and 215mm and in Trim and No Trim versions.

Colores
Colours

Downtown Trim

- 30 Blanco
- 30 White



Downtown No Trim



DOWN TOWN

DOWN TOWN Ø160
TRIM / NO TRIM



TC-TEL
GX24q
18/26W

DOWN TOWN Ø215
TRIM / NO TRIM



TC-TEL
GX24q
18/26/32/42W



TC-DEL
G24q
18/26W

Downtown Trim
Ø160

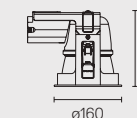

Downtown Trim
Ø215

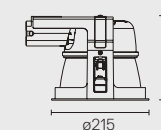

Downtown No Trim
Ø160

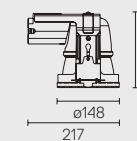

Downtown No Trim
Ø215

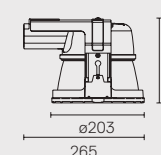

DOWNTOWN

DOWNTOWN



El sistema de rotación del portalámparas presente en toda la gama Downtown facilita la sustitución de la lámpara.

The lamp change is effected easily because the lampholders can being swivelled in all the Downtown range.

TRIM



La instalación de la luminaria se realiza fácil y rápidamente sin necesidad de herramientas especiales.

Fast and easy luminaire installation. No special tools required.

NO TRIM



Sistema de fijación de la luminaria diseñado para falsos techos de hasta 30mm de espesor.

Luminaire fixing system for ceiling thicknesses of 0-30mm.



Con las distintas series de Downlights, Flos puede satisfacer la mayor parte de las necesidades de iluminación profesional en edificios de servicios y locales comerciales, así como en el hogar; gracias a su amplia gama que incluye varios tamaños, diversos tipos de lámparas y potencias, con prestaciones lumínicas elevadas y posibilidad de diferentes pantallas protectoras capaces de satisfacer cualquier petición que el diseñador realice.

DOWNLIGHTS

With its different downlight series, Flos is capable of satisfying the majority of professional lighting needs in services buildings and commercial premises as well as in the home, thanks to its wide range of lights that includes several sizes, different types of lamps and power ratings. It has high luminous performance and offers the possibility of protective shields that are able to satisfy any requirements that designers may have.





GOOD SQUARE

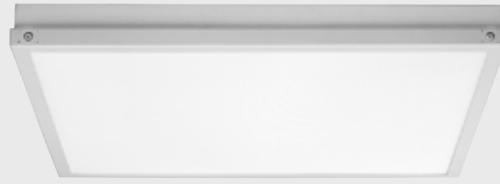

Luminaria de superficie para interiores de muy fácil instalación en techos modulares de 60x60mm. Debido a su gran superficie de emisión lumínica, Good Square proporciona una distribución de luz homogénea y uniforme. Disponible en dos temperaturas de color: 3000K y 4000K.

Surface-mounted easy-to-install luminaire for indoor use, in 60x60mm modular ceilings. Due to its large light emitting surface area, the Good Square provides homogeneous and even light distribution. Available in two colour temperatures: 3000K and 4000K.

Colores Colours

30 Blanco
30 White



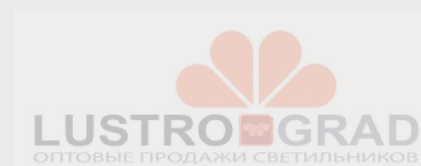

390



GOOD SQUARE



TOP LED
31W
2790 lm
3000K/CRI 80

TOP LED
31W
3000 lm
4000K/CRI 80

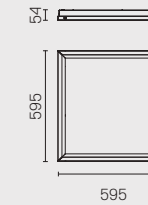

391

GOOD SQUARE

GOOD SQUARE



Luminaria de líneas estilizadas ligera y de gran superficie.

Lightweight, stylised line luminaire to light up large surface areas.



Distribución de LEDs que garantiza una luz homogénea y uniforme.

LED distribution that guarantees homogeneous and even light.



Producto específicamente diseñado para techos modulares de 60x60mm.

Specifically designed product for 60x60mm modular ceilings.





ORA BRESSO HOTEL - ITALY

ECOLIGHT



Luminarias empotrables para ser instaladas en interiores con lámparas de fluorescencia compacta. Cuerpo óptico realizado totalmente en material termoplástico autoextinguible de color blanco; elementos antirreflejos metalizados mediante procedimiento de aluminizado en vacío. Sistema de fijación con pinzas flexibles de acero inoxidable. Bornera para conexiones múltiples que permite la derivación de la línea de alimentación.

Recessed luminaires for indoor installation for compact fluorescent lamps. Self-extinguishing, thermoplastic white reflector housing; vacuum-aluminium coated anti-glare elements. Fixing system with flexible stainless steel springs. Terminal block for multiple connections provided.

Colores
Colours

- 30 Blanco Mate
- 30 Matt White



Aro embellecedor realizado en aluminio y acabado en pintura en polvo blanca, gris o negra. Aluminium ring with powder-coated finish, available with various motifs: white, grey or black.



ECOLIGHT



TC-DEL
G24q
18/26W



TC-TEL
GX24q
18/26/32/42W

Reflector/
Diffuser

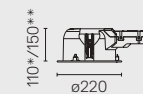

*=2x26W; **=2x32W



*=2x16W; **=2x32W

Emergency



*=2x18/26W; **=2x32W



Equipo electrónico incorporado en la propia luminaria con portalámparas incluido para versiones de 26 y 32W.

Electronic transformer integrated in the lamp with the lamp holder included in the 26W and 32W versions.



Terminal de conexión previsto para realizar conexiones en serie.

Cablehead for series connection.



Marco metálico realizado en acero como accesorio para personalizar el acabado final de la luminaria.

Metal accessory consisting of a steel frame for a customized colour of the luminaire.



ORBITAL



Familia de luminarias empotradas para lámparas halógenas directas a red, halógenas de 12V y de halogenuro metálico.
Disponible en dos dimensiones: Micro Orbital y Orbital.

Micro Orbital

Luminaria empotrable para lámparas halógenas de muy baja tensión y directas a red con reflector incorporado. Aro para empotrar en aleación de aluminio inyectado a presión y pintado con barniz en polvo. Aro antirreflejos realizado en material termoplástico de color negro y cuerpo para empotrar de metal pintado con barniz en polvo de color negro. Aro de cierre realizado de material termoplástico negro. Sistema de fijación con pinzas flexibles de acero inoxidable. Apto para instalaciones en techos de 1 a 25mm de espesor.

Orbital

Luminaria empotrable diseñada para utilizar lámparas halógenas de baja tensión (12V) y de halogenuro metálico. El reflector va incorporado en la propia luminaria. Cilindro de empotramiento realizado en aluminio con sistema de fijación mediante pinzas flexibles en acero inoxidable. Cuerpo basculante realizado en aluminio.

Family of embedded luminaires for halogen lamp direct network, 12V halogen and metal halide.
Available in two sizes: Micro Orbital and Orbital.

Micro Orbital

Recessed luminaire for 12 volt & main voltage halogen reflector lamps. Die-cast aluminum alloy ring, with powder-coated finish. Black thermoplastic anti-glare ring and recessed housing in black powder-coated metal. Black thermoplastic closing ring. Fixing system with flexible stainless steel springs. Suitable for ceiling thicknesses of 1-25mm.

Orbital

Recessed luminaire for low voltage and metal halide lamps. Die-cast aluminum alloy ring, and Fixing system with flexible stainless steel springs. Aluminum dumper body.

Colores Colours

30 Blanco Mate
30 Matt White

02 Gris
02 Grey

14 Negro Mate
14 Matt Black



Rotación Rotation Features

Micro Orbital
Puede ser orientado 35° hacia el exterior y 20° hacia el interior.
Rotación 360°.

Adjustable versions can be swivelled 35° outwards and 20° inwards and rotated 360°.

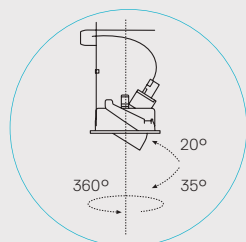

Orbital
Puede ser orientado 60° hacia el exterior y 20° hacia el interior.
Rotación 360°.

Adjustable versions can be swivelled 60° outwards and 20° inwards and rotated 360°.

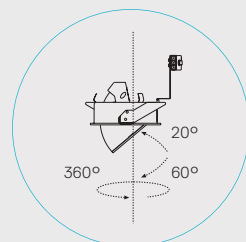

400

ORBITAL

MICRO ORBITAL



PAR 16
GZ10
MAX 50W
- OR -
LED PAR 16
4W



QR-CBC 51
GX5.3
MAX 50W
- OR -
LED QR-CBC 51
7/10W

ORBITAL



CDM-TC
G8.5
MAX 70W

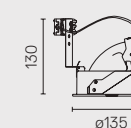
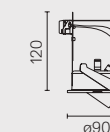
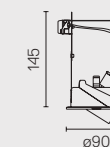

401

Luminaria empotrada con grado de protección IP65 para uso interior/exterior. Equipada con LED de última generación, G-O está especialmente concebido para servir de señalización a lo largo de caminos de paso o escaleras. Está disponible en los acabados blanco, aluminio, acero inoxidable, bronce y negro. El equipo óptico puede emitir luz blanca cálida o ámbar gracias a los difusores coloreados de su interior.

G-O

Recessed luminaire with IP65 protection degree for indoors/outdoors use. Equipped with latest generation LED, G-O is especially designed as bollard lighting for pathways or steps. It is available in white, aluminium, stainless steel, bronze and black finishes. The optical equipment can transmit warm white or amber light thanks to the coloured diffusers on the inside.





PUBLIC BALCONY - SPAIN

G - O



Luminaria empotrada concebida para uso interior en todos sus acabados, excepto el acero inoxidable que es apto también para uso exterior.
 Disponible con fuente de luz LED de última generación apta para responder a las diversas necesidades de señalizadores a lo largo de caminos de paso o escaleras. Disponible en diferentes colores de luz mediante un difusor interno coloreado. El cuerpo de la luminaria está realizado en aluminio, acero inoxidable o bronce mecanizado.

Embedded light fixture for indoor use in all its finishes, except stainless steel which is suitable for outdoor use.
 Available with next-generation LED light source, suitable for responding to diverse signalling needs on pathways or stairways. Available in different light shades, through coloured internal diffuser. Light body made of aluminium, stainless steel or machined bronze.

Colores Colours

30 Blanco
30 White

29 Aluminio Anodizado
29 Anodized Aluminium

55 Acero Inoxidable
55 Stainless Steel



BZ Bronce
BZ Bronze

AN Negro Anodizado
AN Anodized Black



Colores de la Luz Light Colours

Luz Blanca
White Light

Luz Ámbar
Amber Light

Luz Azul
Blue Light



G - O



TOP LED
0,96W
78 1m
3000K
CRI 85



PRIVATE SOLARIUM - SPAIN

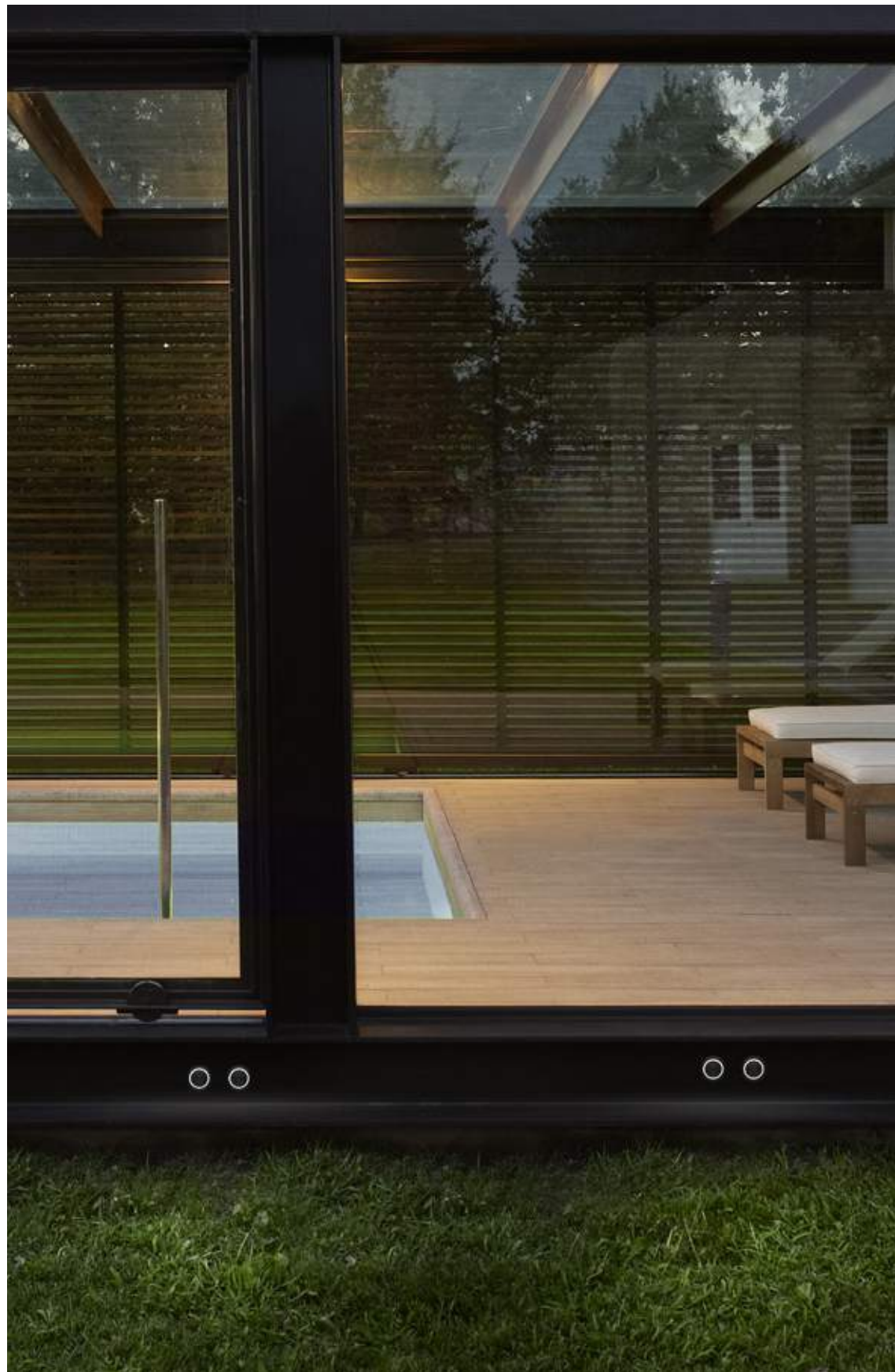

408

PRIVATE BOAT - ITALY

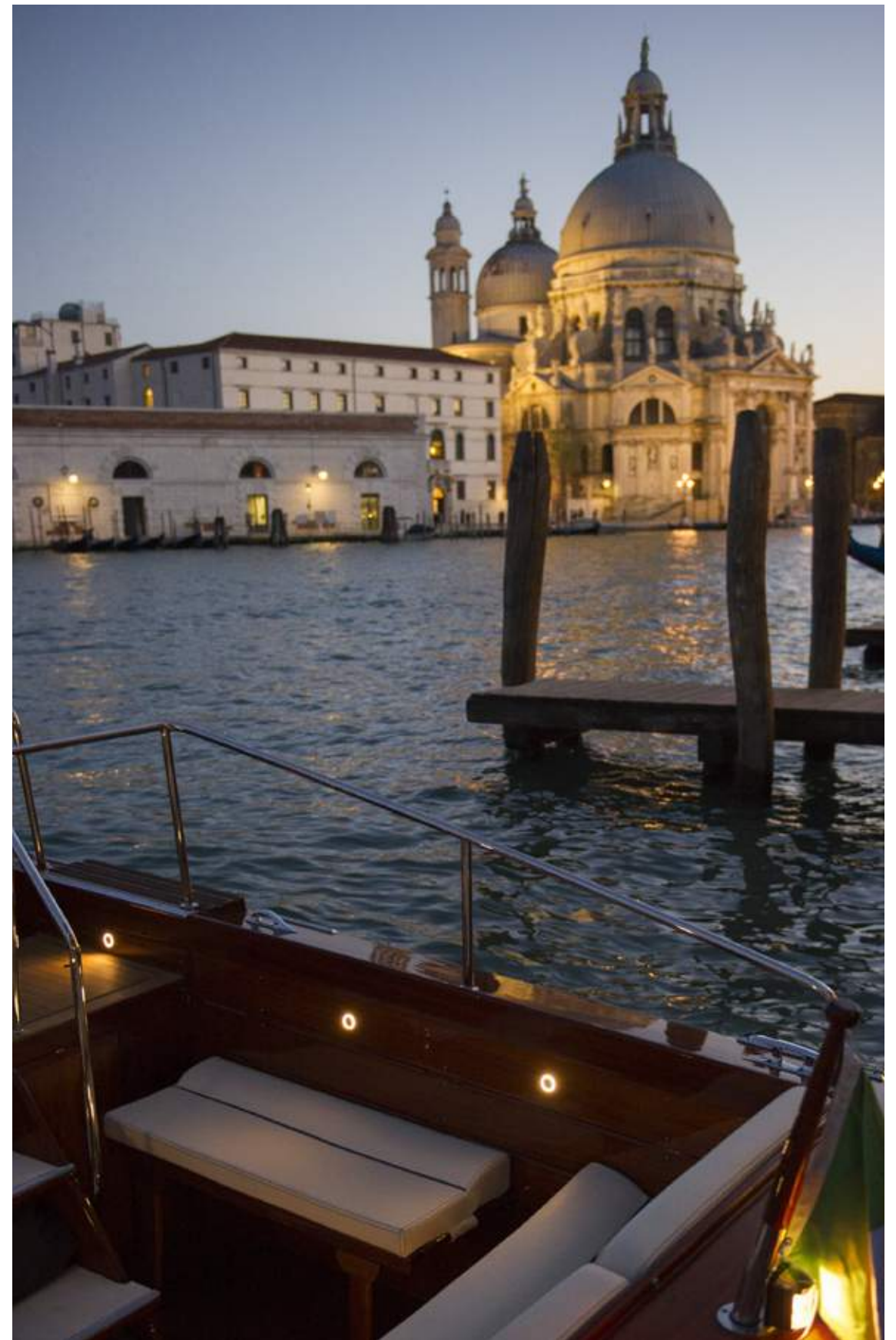

409

G - O

G - O



Especialmente diseñada para la señalización de espacios arquitectónicos como escaleras, caminos, etc.
Grado de protección IP65 que garantiza su uso para exteriores/interiores.

Epecially designed for signage of architectural spaces such as stairs, pathways, etc.
IP65 protection degree guaranteeing correct outdoor/indoor use.





VERDURA GOLF & SPA RESORT - ITALY

Luminaria empotrada de señalización. Perfecta para interiores/exteriores gracias a su grado de protección IP65. TheBlockofLight cuenta con un Power LED de última generación y un difusor opal que hace que la distribución luminosa sea óptima.

THEBLOCK OFLIGHT

Recessed signage luminaire. Perfect for indoors/outdoors thanks to its IP65 protection degree. TheBlockofLight has a latest generation Power LED and an opal diffuser for optimal light distribution.





PRIVATE HOUSE - SPAIN

THEBLOCKOFLIGHT



Luminaria empotrada concebida para uso interior o exterior (grado de protección IP65). Disponible con fuente de luz LED de última generación apta para responder a las diversas necesidades de señalizadores a lo largo de caminos de paso o escaleras.

Embedded light fixture designed for indoor or outdoor use (IP65 protection grade). Available with next-generation LED light source in response to diverse signalling needs on pathways or stairways.

Colores
Colours

01 Blanco Mate
01 Matt White

72 Gris
72 Grey

04 Negro Mate
04 Matt Black



THEBLOCKOFLIGHT



POWER LED
2,2W
154 lm
3000K
CRI 80

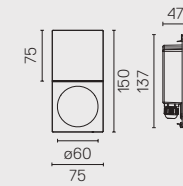

THEBLOCKOFLIGHT



Luminaria empotrada con fuente de luz LED de última generación. Grado de protección IP65 que garantiza su correcto funcionamiento en exteriores.

Recessed luminaire with latest generation LED light source. IP65 protection degree guaranteeing correct outdoor use.

THEBLOCKOFLIGHT





PRIVATE OFFICES - JAPAN

Las luminarias empotradas Giano, con un grado de protección IP65, están equipadas con fuentes de luz LED y proyectan luz por debajo de un ángulo de aprox. 15° por debajo de la horizontal. De esta forma, se convierten en verdaderos bañadores ideales para iluminar de una forma selectiva tanto pasillos y corredores en instalaciones de interior/ exterior, terrazas, patios, caminos de acceso a garajes o urbanizaciones.

GIANO

The Giano recessed luminaires, with IP65 protection degree, are equipped with LED light sources and they project light at an angle of less than 15°, approximately, below the horizontal plane. In this way, they act as floor washers, ideal for lighting corridors in both indoor and outdoor facilities, terraces, driveways or housing estates.





GIANO



Familia de luminarias de señalización para exterior e interior disponible en dos diámetros 100mm y 220mm. Cuerpo principal inyectado en aleación de aluminio a presión. Acabado realizado en pintura antioxidante de alta resistencia a la corrosión. Dispone de un difusor de policarbonato opal para obtener una luz uniforme.

Family of luminaires for both interior and exterior signaling available in two sizes 100mm and 220mm. Main body injected in alloy aluminium under pressure. Anti-rust paint finish made in high resistance to corrosion. It has an opal polycarbonate diffuser to obtain a uniform light.

Colores Colours

01 Blanco Mate
01 Matt White

72 Gris
72 Grey

04 Negro Mate
04 Matt Black

MM Marrón Oscuro
MM Dark Brown

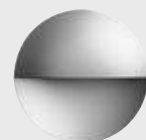

GIANO

GIANO
Ø100



POWER LED
1W
77 lm
3000K
CRI 80

GIANO
Ø220



POWER LED
6W
650 lm
3000K
CRI 80

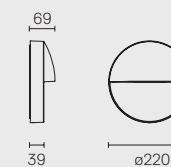
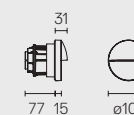



La luminaria de superficie incorpora en su interior los equipos de control para el correcto funcionamiento del LED con un diseño final extraordinariamente compacto.

This surface luminaire incorporates a driver which controls the perfect LED functioning and offers an extremely compact design.



Accesorio de empotramiento para paredes de cemento realizado en elemento termoplástico con carga mineral de gran resistencia mecánica y fácil instalación.

Accessory for recessed mounting on cement walls made of mineral filled thermoplastic for high mechanical resistance and easy installation.





PRIVATE HOUSE - SPAIN

Famille von Wandeinbauleuchten mit asymmetrischem Licht für eine optimale Beleuchtung bei jeder Anwendung. Die jüngsten Ausführungen verfügen über die neueste LED-Technologie. Das neue Einbauzubehör ermöglicht einen perfekten Wandeinsatz.

BOX

Famille d'appareils à encastrer au mur avec lumière asymétrique étudiée pour offrir un rendement lumineux optimal dans toutes les situations d'utilisation. Les nouvelles versions ont été équipées des lampes LED de dernière génération. Nouvel accessoire à encastrer pour une installation parfaite à l'intérieur de la surface.



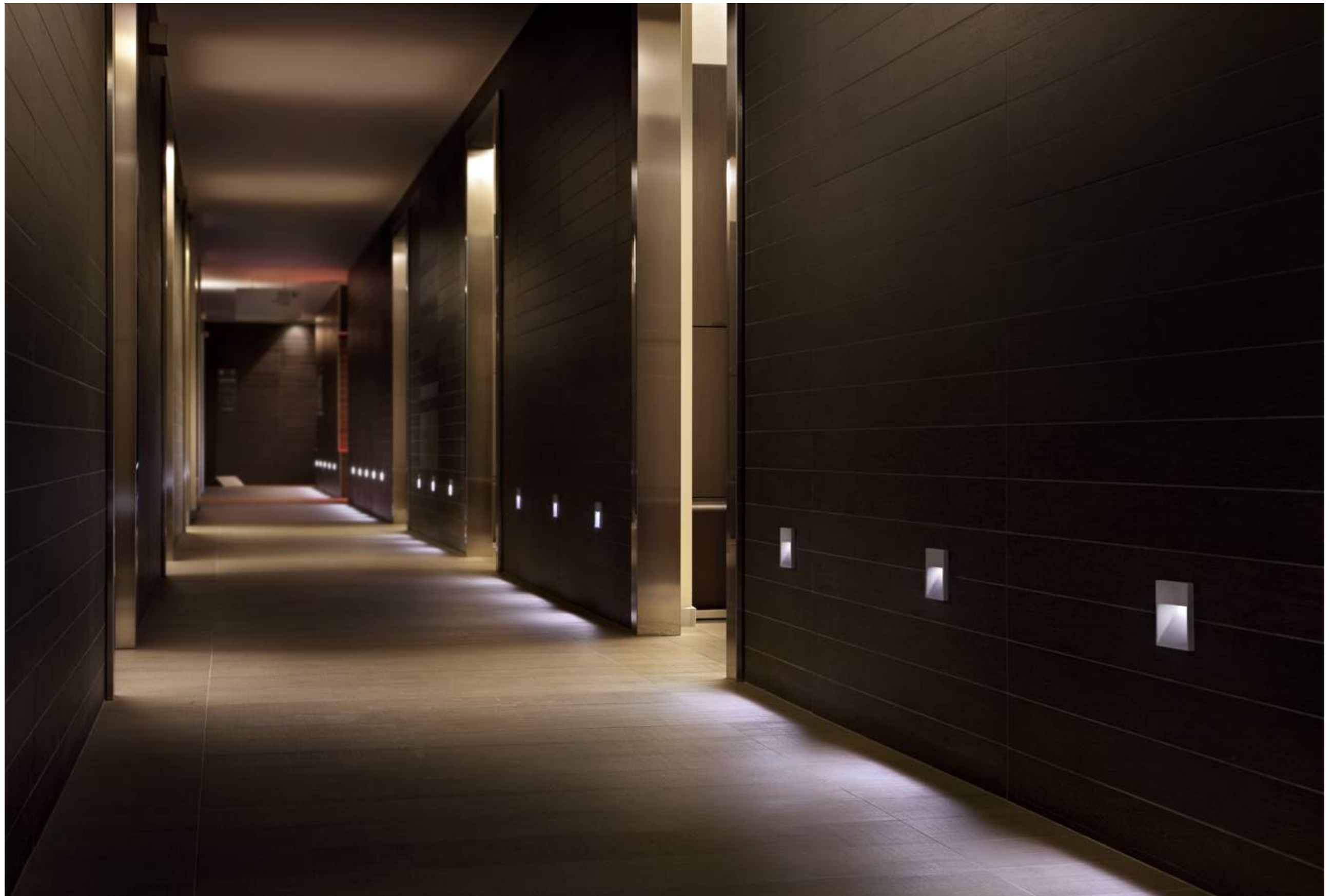

VIRGIN ACTIVE - ITALY

BOX



Familia de luminarias de señalización para exteriores e interiores disponible en dos tamaños: 100x100mm y 236x256mm. Cuerpo principal inyectado en aleación de aluminio a presión. Pintura antioxidante de alta resistencia a la corrosión. Cuerpo trasero inyectado en policarbonato de alta resistencia. Difusor de policarbonato para la protección de la fuente de luz. Juntas de silicona. Tornillos de acero inoxidable. Prensacables tipo PG9 ó PG11.

Range of indoor and outdoor guidelights in two sizes: 100x100mm and 236x256mm. Die-cast aluminum front ring. High corrosion-resistance anti-oxidizing paint. High-resistance injection-moulded engineering plastic. Polycarbonate diffuser for lamp protection. Silicone seals. Stainless steel screws. PG9 or PG11 cable glands.

Colores
Colours

01 Blanco Mate
01 Matt White

72 Gris
72 Grey

04 Negro Mate
04 Matt Black

MM Marrón Oscuro
MM Dark Brown



BOX

BOX



POWER LED
5W
500 lm
3000K
CRI 80



TC-DEL
G24q
18/26W

MINI BOX



POWER LED
2W
110 lm
3000K
CRI 80



QT-14
G9
MAX 25W



QT-9
G4
20W

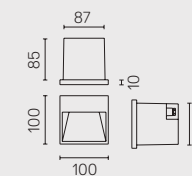
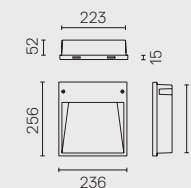

BOX

BOX

VIRGIN ACTIVE - ITALY

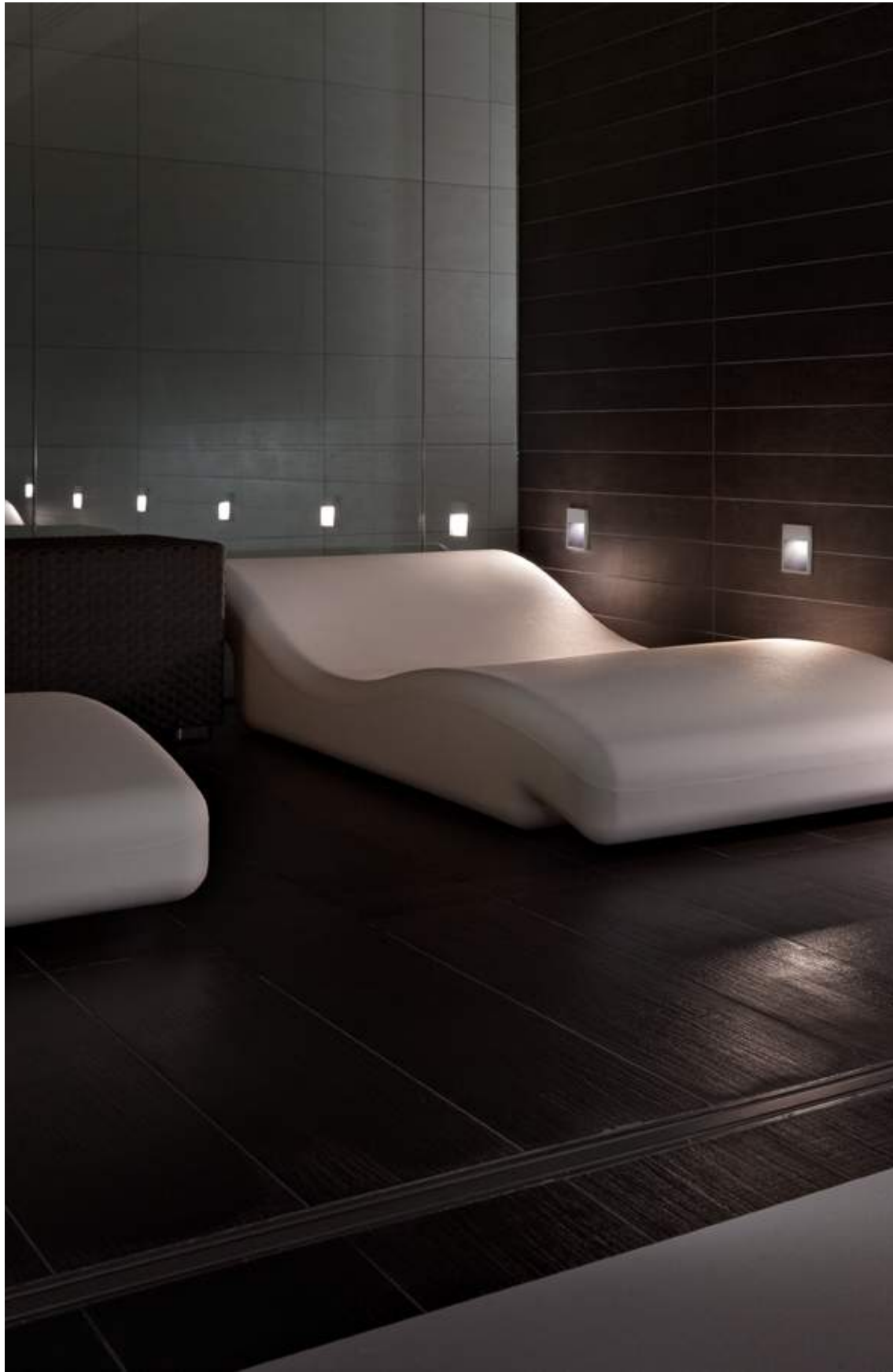

440

VIRGIN ACTIVE - ITALY

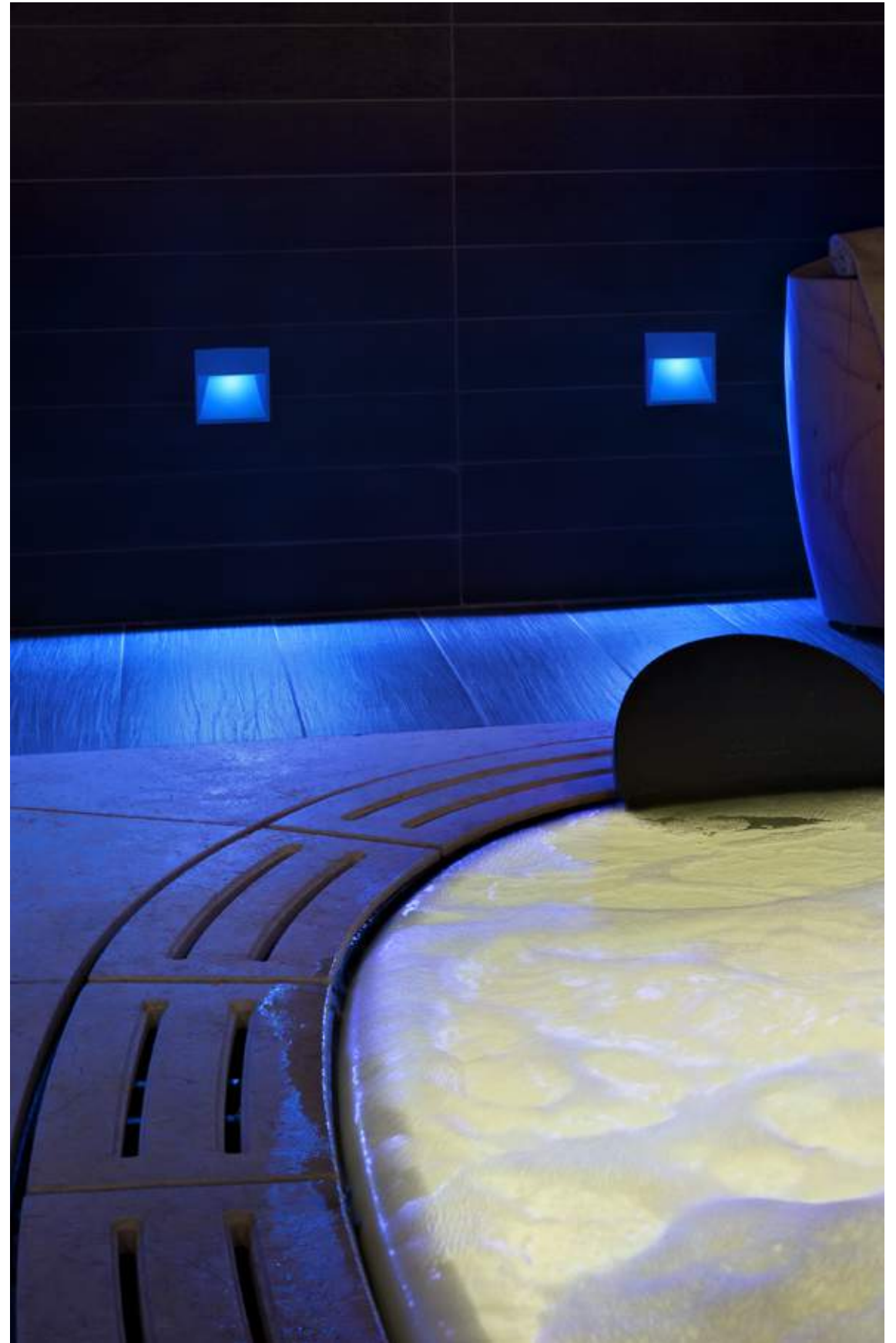

441

BOX

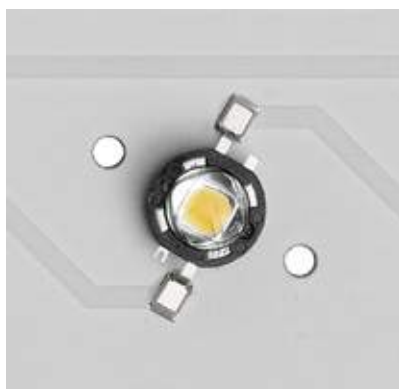

Power LED de 2W alimentado a corriente constante de 500 mA con una temperatura de color de 3000K.

2W Power LED, 500 mA constant current, colour temperature of 3000K.



Accesorio para instalaciones sobre paredes de cemento realizado en acero inoxidable con marco de empotramiento en material termoplástico. Permite la instalación del producto tanto en versión semi-empotrada como totalmente a ras de la pared.

Accessory made of stainless steel for installation on cement walls, with thermoplastic frame for recessed installation. It allows the product to be installed both as a semi-recessed luminaire and as a wall surface luminaire.

BOX



Gama de aparatos empotrados para la iluminación, concebida para una gran variedad de usos, tanto en interior como en exterior (grado de protección IP66). Entre las lámparas encontramos diferentes tipos de LED de última generación aptos para responder a las diversas necesidades: iluminación de paredes verticales o simplemente como señalizadores a lo largo de caminos de paso.

NEUTRON

Range of recessed devices for lighting, designed for a wide variety of uses, both indoors and outdoors (IP66 protection degree). Among the lamps we can find different kinds of latest generation LED that are able to respond to different needs: vertical wall lighting, or simply as bollards that light up pathways.





ORA BRESSO HOTEL - ITALY

NEUTRON



Luminaria orientable para empotrar a techo o a suelo, con LED o lámparas halógenas de muy baja tensión tipo QR-CBC 35. Cuerpo para empotrar inyectado a presión en aluminio con alta resistencia a la corrosión y a la degradación. Cristal de protección templado de 6mm de espesor. Juntas de silicona. Aro de cierre con tornillos de fijación de acero inoxidable. Prensacables tipo PG9 con cable de alimentación incluido de 1m de longitud.

Adjustable recessed luminaire for ceilings or in ground applications, for LEDs or 12 volt halogen QR-CBC 35 lamps. Die-cast aluminum recessed housing, high corrosion-resistance. 6mm tempered protection glass. Silicone seals. Stainless steel closing ring with fixing screws. PG9 cable gland with pre-wired 1 metre power loom.

Colores
Colours

Neutron I No Trim

■ 14 Negro
■ 14 Black



Neutron I

■ 04 Negro Mate
■ 04 Matt Black



■ 72 Gris
■ 72 Grey



■ 55 Acero Inoxidable
■ 55 Stainless Steel



■ PB Acero Inoxidable Cobre Oscuro
■ PB Stainless Steel Dark Copper



■ PG Acero Inoxidable Oro
■ PG Stainless Steel Gold



■ PN Acero Inoxidable Negro
■ PN Stainless Steel Black



Rotación
Rotation Features

Las versiones basculantes pueden ser orientadas 30° y rotadas 355°. Adjustable versions can be swivelled 30° and rotated 355°.

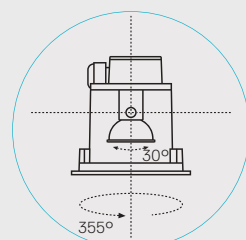

NEUTRON

NEUTRON I
NO TRIM



POWER LED
4,2W
425 lm
3000K
CRI 80

NEUTRON I



PHOSPHOR LED
8,3W
720 lm
3000K
CRI 80



POWER LED
1W
90 lm
3000K/CRI 80
6W
480 lm
3000K/CRI 80



QR-CBC 35
GU4
MAX 20W

No Trim

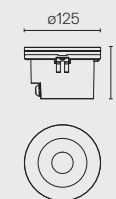

Fixed Round Ceiling

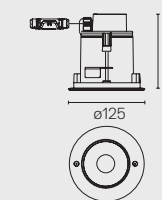
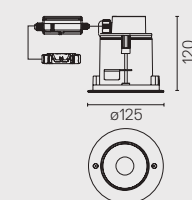

Adjustable Ceiling



Fixed Round Floor

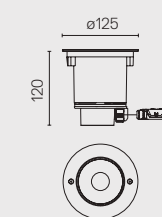
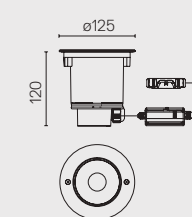

Adjustable Floor

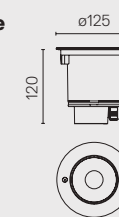

Fixed Square Ceiling

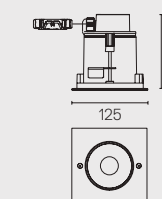
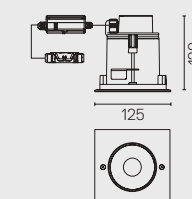

Fixed Square Floor

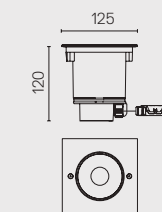
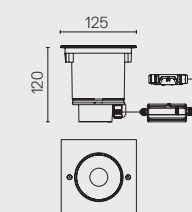

EUROSTARS MADRID TOWER HOTEL - SPAIN



450

PRIVATE OFFICES - TURKEY



451



Luminaria empotrada para instalaciones de exterior con LED de tecnología de fósforo remoto de 8,3W con temperatura de color de 3000K y flujo luminoso de 720 lm. Reproducción cromática de 80.

Recessed luminaire for outdoor installation with 8,3W remote phosphor LED, colour temperature of 3000K and luminous flux of 720 lm. Colour rendering 80.



Luminaria compuesta por 6 Power LED alimentados a corriente constante de 4,2W. Temperatura de color de 3000K. Reproducción cromática de 80. Ópticas disponibles en diversas aperturas angulares: 10°, 21° y 37°.

Luminaire consisting of 6 Power LEDs with 4,2W constant current. Colour temperature of 3000K. Colour rendering 80. The optics are available with different light beam angles: 10°, 21° and 37°.



La nueva versión de la luminaria de señalización incorpora una lente de distribución del haz luminoso a 180° con un Power LED de 1,2W.

The new signal version of the luminaire includes a light distribution lens with 180° angle and 1,2W Power LEDs.



La luminaria en su versión a LED con fósforo remoto incorpora un alimentador electrónico necesario en un cuerpo estanco externo con grado de protección IP67.

The remote phosphor LED version of the luminaire includes an electronic driver placed inside an airtight housing with protection class IP67.

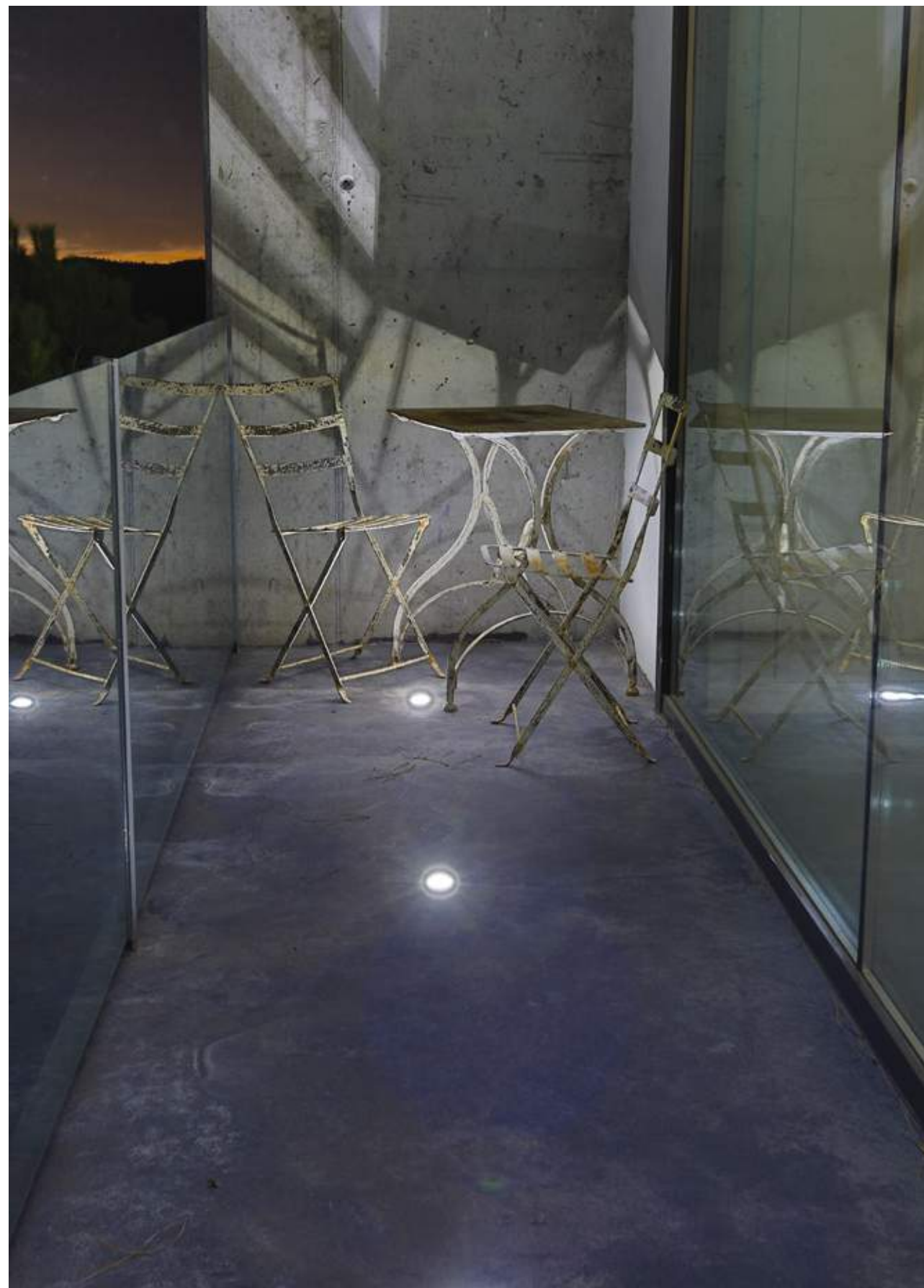



MUNDALIN HOTEL - ITALY

FARETTO

Proyectores de dimensiones pequeñas de alto rendimiento. Gracias a sus características, se prestan a múltiples usos tanto en el ámbito público como en el residencial.

FARETTO

High performance small-sized spotlights. Thanks to their characteristics, they are suitable for many different uses both in the public and residential sectors.





PRIVATE HOUSE - ITALY

FARETTO

MINI FARETTO



Familia de proyectores para instalación en exteriores, dos tamaños: ø99, ø138. Versiones con distintas aplicaciones, a base, en pared o fachada. Diseñado para lámparas halógenas de muy baja tensión, directas a red o de halogenuros metálicos. Cuerpo de aluminio inyectado a presión y pintado con barniz en polvo. Cristal templado de protección de 6mm de espesor. Cono de protección antideslumbramiento, de polímero, dentro del cuerpo. Anillo interno para la fijación de la lámpara. Juntas de silicona.

FARETTO



Range of outdoor spotlights, base mounted, wall or façade versions, in two sizes: diam. 99mm, diam. 138mm. For halogen or metal halide lamps. Die-cast aluminum, powder-coated body. 6mm tempered glass cover. Polymer anti-glare screening cone inside the body. Inner ring for lamp mounting. Silicone seals.

Colores
Colours

01 Blanco Mate
01 Matt White

72 Gris
72 Grey

04 Negro Mate
04 Matt Black

MM Marrón Oscuro
MM Dark Brown



Rotación
Rotation Features

Puede ser orientado 110° y rotado hasta 355° según versiones.
Can be swivelled 110° and rotated up to 355° depending on versions.

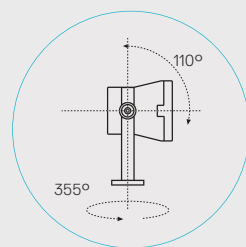

FARETTO

MINI FARETTO
OUTDOOR

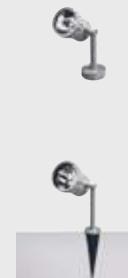

PAR 16
GZ10
MAX 50W

QT-12
GY6.35
MAX 50W

QR-CBC 51
GX5.3
MAX 50W
- OR -
LED QR-CBC 51
7W

MINI FARETTO
OUTDOOR



QT-12
GY6.35
50W

QR-CBC 51
GX5.3
50W
- OR -
LED QR-CBC 51
7W

FARETTO
OUTDOOR



QT-12
GY6.35
75W

QT-18
B15d
MAX 100W

FARETTO HIT
OUTDOOR



HIT-CRI
G12
35/70W

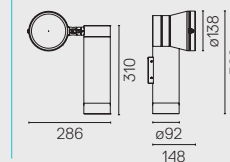
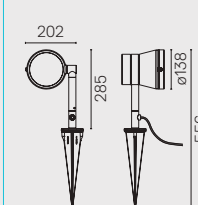
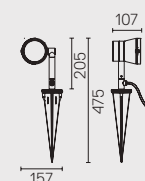
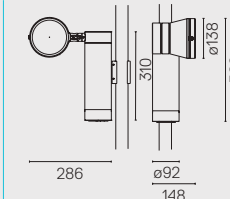
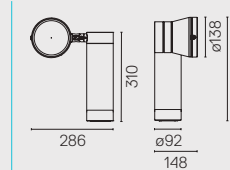
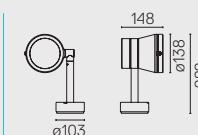
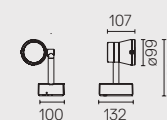
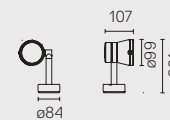

FARETTO

FARETTO

PRIVATE HOUSE - ITALY



PRIVATE GARDEN - ITALY



462

463

Diseño y características técnicas hacen de esta familia de aparatos de iluminación una solución ideal en cualquier aplicación, tanto en el interior como en el exterior. Fuente de iluminación fluorescente.

STEALTH

The design and technical characteristics make this family of lighting devices an ideal solution in any application, both indoors and outdoors. Fluorescent lighting source.



DESIGNED BY PIERO LISSONI



VERDURA GOLF & SPA RESORT - ITALY

STEALTH / STEALTH LINEAR

STEALTH



Luminaria de señalización para lámparas fluorescentes compactas. Cuerpo trasero inyectado en policarbonato de alta resistencia. Cuerpo principal inyectado en aleación de aluminio a presión con elevada resistencia a la corrosión. Difusor de policarbonato con o sin rejilla antivandalismo. Pintura en polvo de poliéster. Juntas de silicona. Tornillos de acero inoxidable. Prensacables tipo PG11.

Range of step lights designed for compact fluorescent lamps. Highly resistant injection-molded polycarbonate body. Highly corrosion-resistant, die-cast aluminum front frame. Polycarbonate diffuser with or without die-cast aluminum anti-vandalism screen. Polyester powder-coated. Silicone seals. Stainless steel screws. PG11 cable gland.

STEALTH LINEAR



Luminaria de señalización para lámparas de fluorescencia compacta. Cuerpo trasero inyectado en policarbonato de alta resistencia. Cuerpo principal inyectado en aleación de aluminio a presión con elevada resistencia a la corrosión. Difusor de policarbonato con o sin rejilla antivandalismo. Pintura en polvo de poliéster. Juntas de silicona. Tornillos de acero inoxidable. Prensacables tipo PG9. Soporte para lámpara y reflector de policarbonato.

Guidelight designed for compact fluorescent lamps. Highly resistant injection-molded polycarbonate body. Highly corrosion-resistant, die-cast aluminum front frame. Polycarbonate diffuser with or without die-cast aluminum anti-vandalism screen. Polyester powder-coated. Silicone gasket seals. Stainless steel screws. PG9 cable gland. Polycarbonate lamp support and reflector.

Colores
Colours

Stealth

- 01 Blanco Mate
01 Matt White
- 72 Gris
72 Grey
- 04 Negro Mate
04 Matt Black
- MM Marrón Oscuro
MM Dark Brown



Stealth Linear

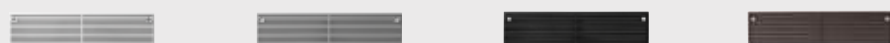

STEALTH / STEALTH LINEAR

STEALTH



TC-F
2G10
24/36W

STEALTH LINEAR



TC-L
2G11
18W

Stealth

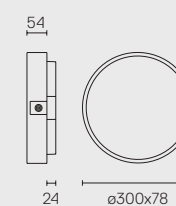

Stealth Screen

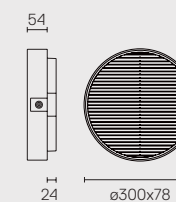

Stealth Linear

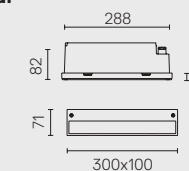

Stealth Linear Screen

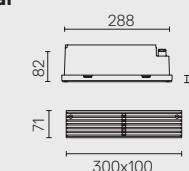

GUT EDIZIONI HEADQUARTERS - ITALY



470

PRIVATE GARDEN - ITALY



471

STEALTH / STEALTH LINEAR

STEALTH LINEAR

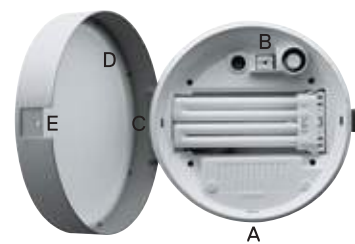

- A Junta de silicona
- B Cuerpo de policarbonato
- C Bisagra
- D Difusor de policarbonato
- E Sistema de cierre

- A Silicone seal
- B Polycarbonate body
- C Hinge
- D Polycarbonate diffuser
- E Closing system

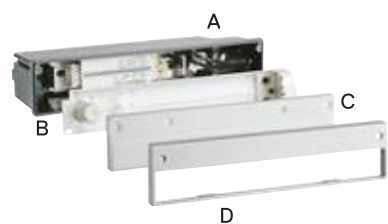

- A Cuerpo de plástico
- B Reflector
- C Difusor
- D Cuerpo delantero

- A Plastic body
- B Reflector
- C Diffuser
- D Front body



SOFT ARCHITECTURE

Juncos, Apps, Wall Rupture, Uso, Uso Cove Lighting,
Wall Piercing, Uso Boob, G-O In, Soft Spun,
Abajourd'hui, Teardrop, Benguerra, Usl, Usl QR 111,
Usl Pluto, Round, Square & Vertical Light,
Usb Round & Square Light, Usb Box, Softprofile,
Kaprofile, Lightlight® In System Profile,
Usp, Usl Out, Usl 900 Disk.

SOFT ARCHITECTURE

Una Fusión Natural entre Materia y Energía, entre la Luz y la Arquitectura A Natural Fusion of Substance and Energy, between Light and Architecture

Amar la luz y la arquitectura, fundirlas con las soluciones más creativas, teniendo como objetivo la búsqueda de las técnicas de iluminación más avanzadas dentro del total respeto del ambiente: Flos Soft-Architecture es una nueva filosofía para vivir poéticamente la fusión entre materia y energía.

Respetar la naturaleza y su equilibrio, comprender su importancia y sacar inspiración de su perfección: Flos Soft-Architecture es el fruto de una profunda búsqueda sobre el uso de los materiales eco-compatibles (certificación Cradle to Cradle) de bajo impacto ambiental.

Unión perfecta de materia y energía, Flos Soft-Architecture utiliza las más avanzadas fuentes para el ahorro de energía (LED, LED a fósforo remoto, power LED, cátodo frío, fluorescencia compacta, halógena, IRC/ES) con el fin de garantizar una síntesis perfecta entre luz, arquitectura y naturaleza.

Loving light and architecture, melting them in the most creative solutions, looking for the most advanced, lighting and technical aims and fully respecting the environment: Flos Soft-Architecture is the new philosophy to live poetically the fusion of substance and energy.

Respecting nature and its balance understanding its value and being inspired by its perfection: Flos Soft-Architecture is the result of an in-depth lighting and technical research on the use of eco-friendly materials (certification Cradle to Cradle) with a low impact on the environment.

Flos Soft-Architecture is a perfect fusion of substance and energy and benefits of the most advanced energy saving sources (LED, Remote Phosphor LED, Power LED, cold cathode, compact fluorescent, halogens, IRC/ES) in order to grant a perfect integration of light, architecture and nature.

CRADLE TO CRADLE

“Respeto por la Naturaleza y su Equilibrio” “Respecting Nature and its Balance”

Producción de Soft Architecture
Soft Architecture Manufacturing

Venta e Instalación
Sale and Installation

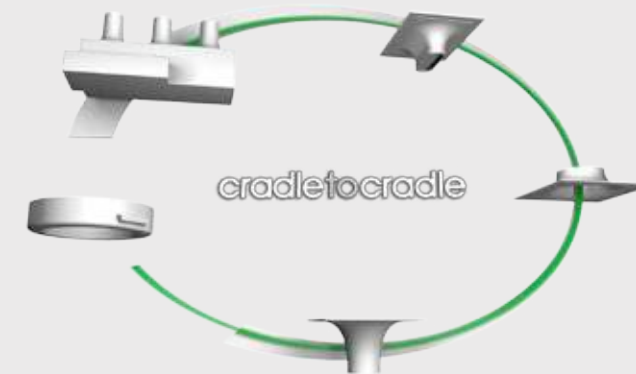

Reciclaje sin Impacto Ambiental
Relocation with no Environmental Impact

Ciclo de Vida Sostenible
Sustainable Lifecycle

UNDER-COVER
technology

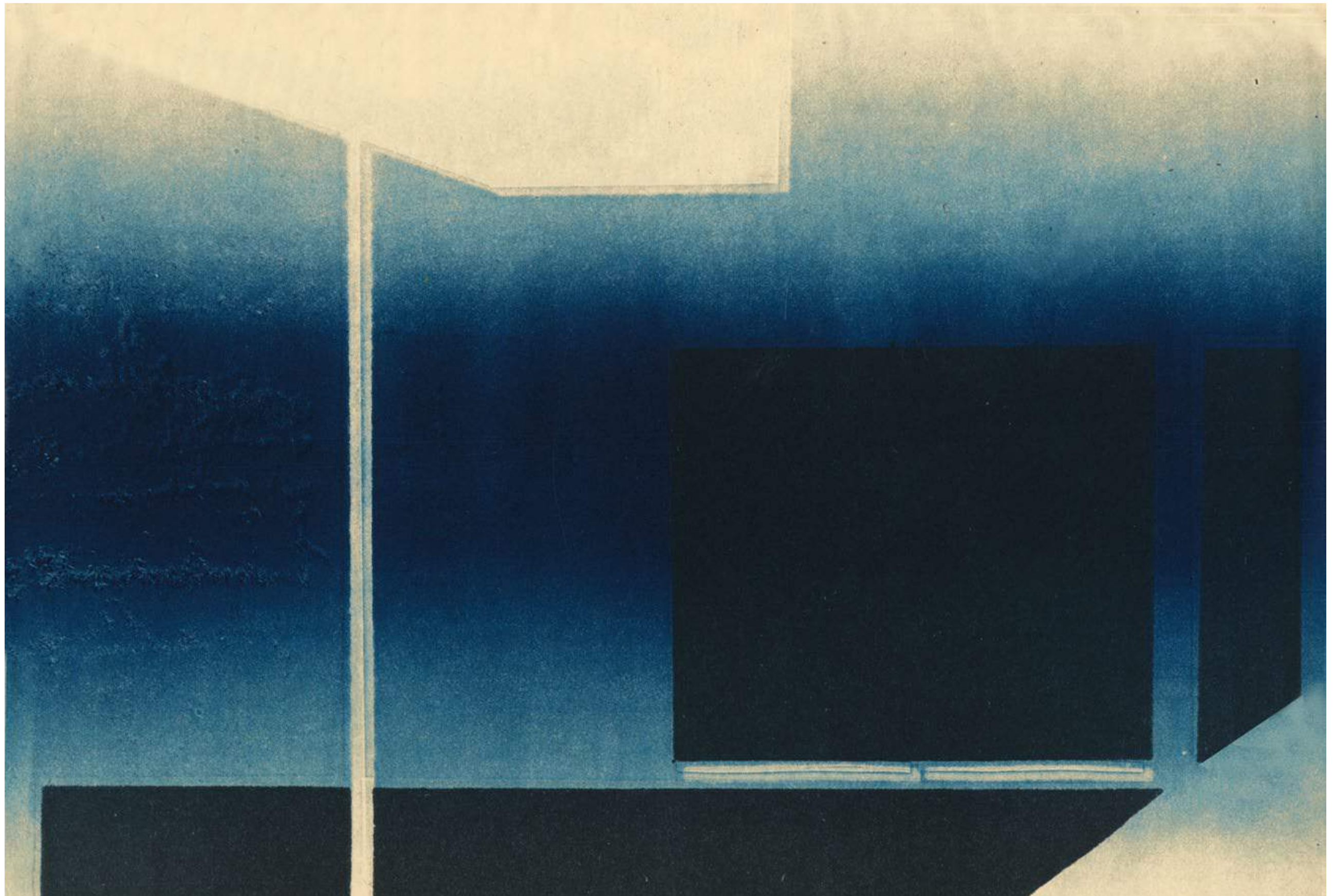

Luminaria inspirada en los grupos de juncos que asoman por la superficie del agua. Con un LED de alta potencia, el tubo se puede bascular e introducir o sacar del techo para orientar el haz de luz y crear la composición deseada.

JUNCOS

Luminaire inspired by 'bunches of reeds' hovering over the water surface. With a high power LED, the tube can be tilted and inserted or removed from the ceiling to direct the beam of light and create the desired artistic composition.

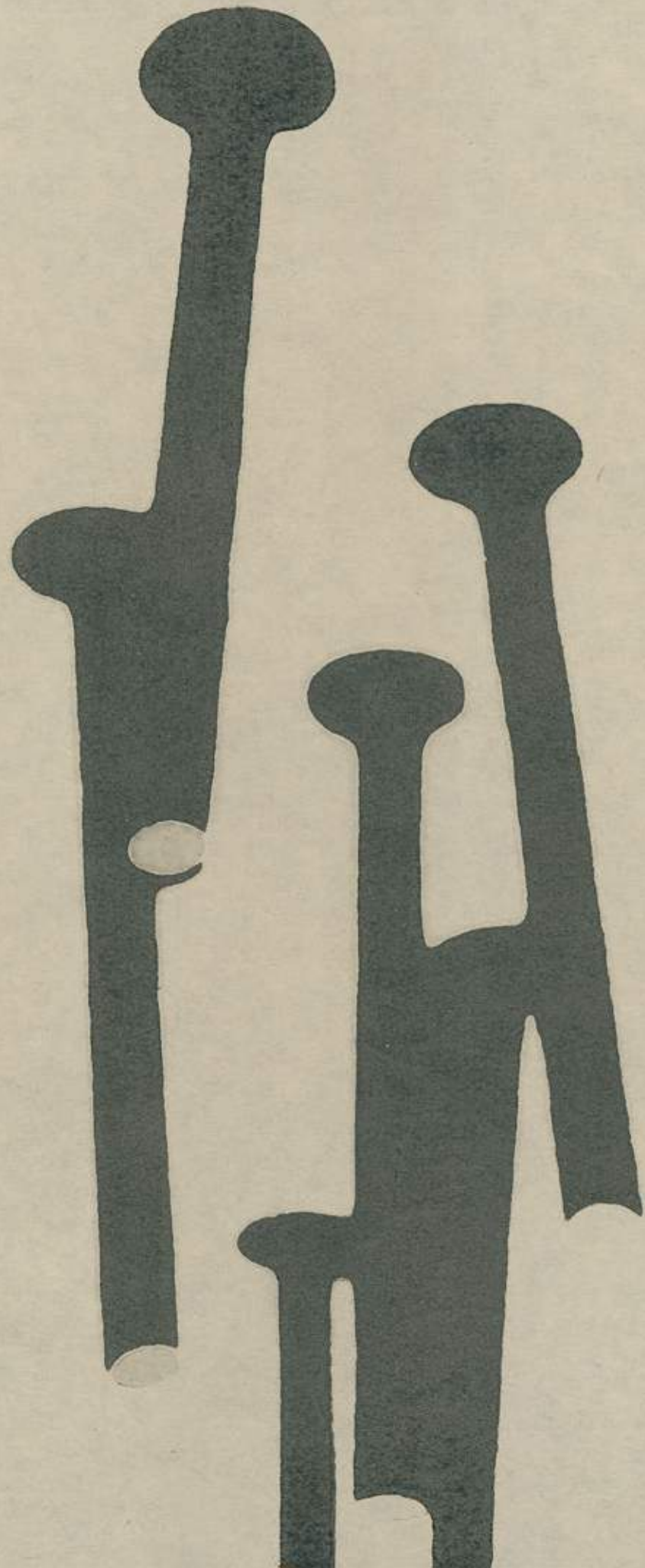

JUNCOS 1L

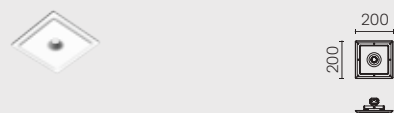

JUNCOS 3L



JUNCOS 6L



JUNCOS 9L

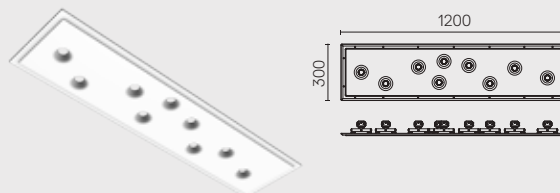

Luminaria LED de interiores semiempotrada que combinada con la tecnología Soft architecture se integra perfectamente en el espacio arquitectural. Fuente de alimentación no incluida.

Semi-recessed LED luminaire for indoor applications. Seamless integration in the architectural environment by Soft architecture technology. Power supply not included.

JUNCO 250 m m

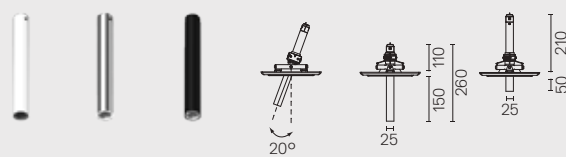

JUNCO 400 m m

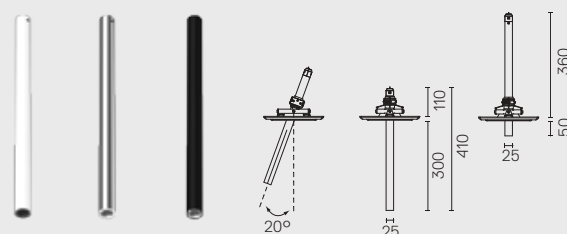

Luminaria que ofrece gran versatilidad. Individualmente orientable y nivel de empotramiento regulable. Disponible en acabado negro, blanco y cromo.

Luminaire that offers many possibilities. Can be individually focused and their recessed height is adjustable. Available in a black, white and chrome finish.





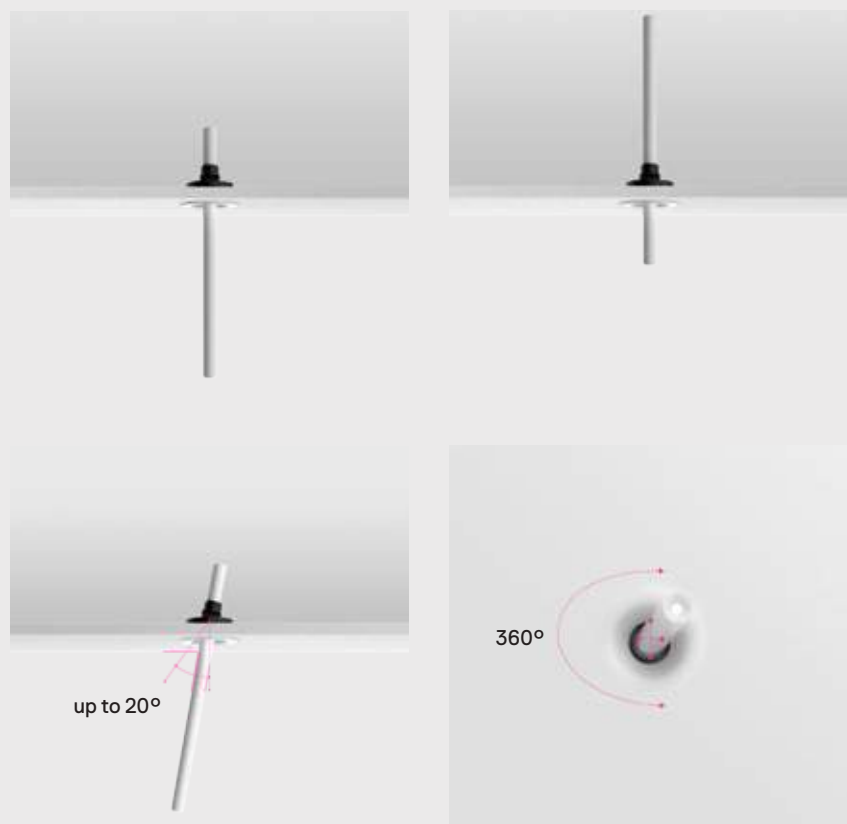

Mediante un mecanismo articulado, instalado en la placa de Soft architecture, el tubo del junco se puede introducir o extraer y bascularse hasta 20 grados desde el eje vertical.

La fuente luminosa es un Power LED de 9W capaz de emitir 700lm de flujo luminoso, que gracias a una lente spot de alta calidad nos proporciona una distribución luminosa óptima.

El tubo de aluminio y el radiador interno proporcionan una evacuación óptima del calor producido por el LED, evitando su sobrecalentamiento y propiciando un rendimiento óptimo y alargando la vida útil del LED.

Las modulaciones de los Juncos (1, 3, 6 y 9) hacen que sea posible crear infinidad de configuraciones que proporcionan una distribución desordenada, como los juncos en el agua. Si se desea crear una configuración "ordenada", se puede usar el módulo de un tubo instalado repetidas veces en línea o formando una matriz.

By a hinge system, installed on the Soft architecture plate, the "reed"-tube can be moved in or out as well as tilted up to 20 degrees on the vertical axis.

The light source is a 9W Power LED emitting a luminous flux of 700lm, which, using a high quality spot lens, provides optimal light distribution.

The aluminium tube and the internal radiator heat prevent the overheating produced by the LED light source. It favours optimal performance and extends the life of the LED.

The Junco modules (1, 3, 6 and 9 tubes) allow for the creation of an infinite number of configurations, imitating the disorderly distribution of reeds in water. If an "orderly" configuration is preferred, then use the 1-tube Junco module and install it forming a straight line or a matrix.



DANIELA HOTEL - ITALY



Luminaria de pared con un mínimo impacto visual para la señalización de espacios con fuentes de luz LED. Completamente customizable, también está disponible en versión de emergencia. Luz indirecta perimetral disponible en tres colores: blanco, naranja y violeta.

APPS

Wall luminaire with minimal visual impact for the signage of spaces with LED light sources. Completely customisable, it is also available in emergency version. Indirect perimeter light, available in three colours: white, orange and violet.



APPS

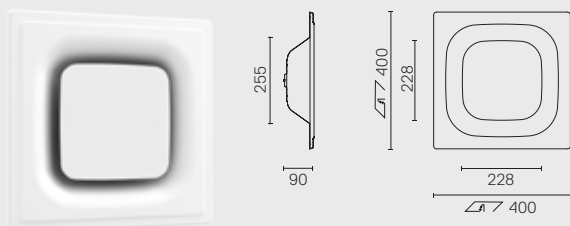

Luminaria empotrada de señalización para aplicación interior. Fuente de alimentación no incluida.

Recessed sign luminaire for indoor application. Power supply source not included.

APPS EMERGENCY

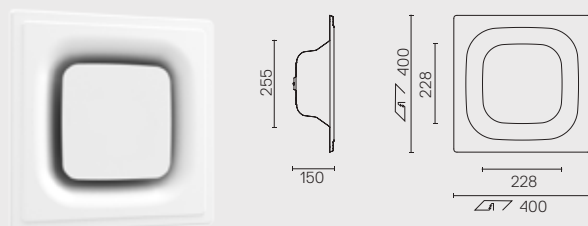

Luminaria empotrada de señalización de emergencia para aplicación interior. Fuente de alimentación y equipo de emergencia incluido. Autonomía 4 horas. Flujo 80%.

Recessed emergency sign luminaire for indoor application. Power supply source and emergency gear included. 4-hour autonomy. 80% Flow.



90° Dir 45° Dir Wc Ladies Wc Men



Wc Bar Restaurant Elevator

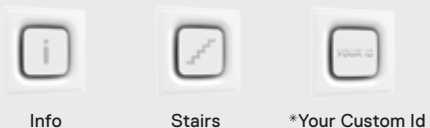

Info Stairs *Your Custom Id



90° Dir 45° Dir Exit Right Exit Left

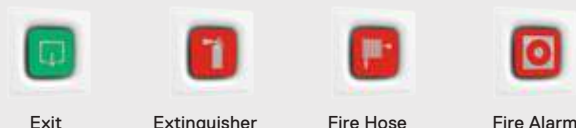

Exit Extinguisher Fire Hose Fire Alarm

Color de la Luz Perimetral
Peripheral Lighting Colours

- Blanco White
- Naranja Orange
- Violeta Violet



Premios Awards



reddot design award
winner 2012



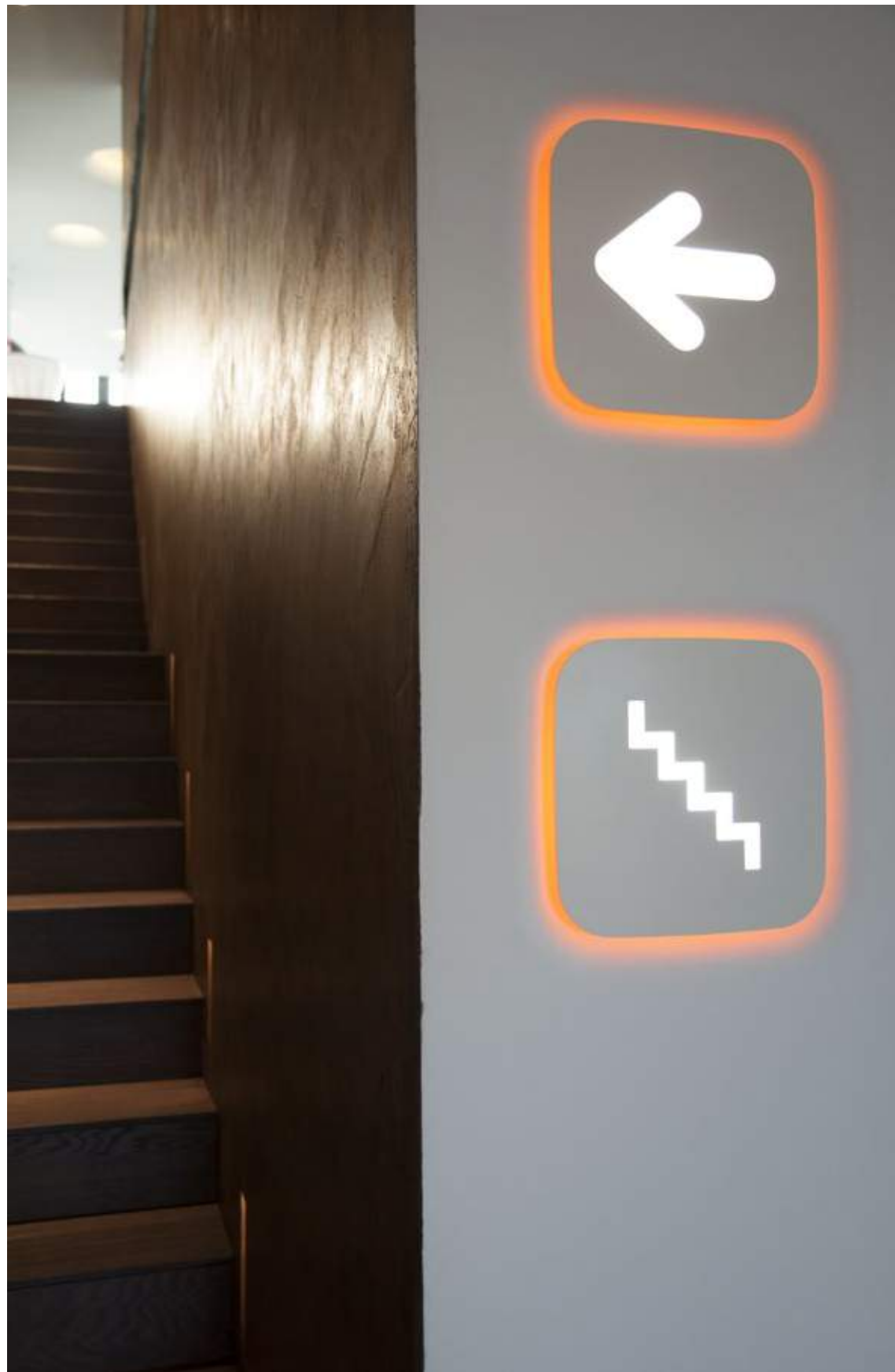

494

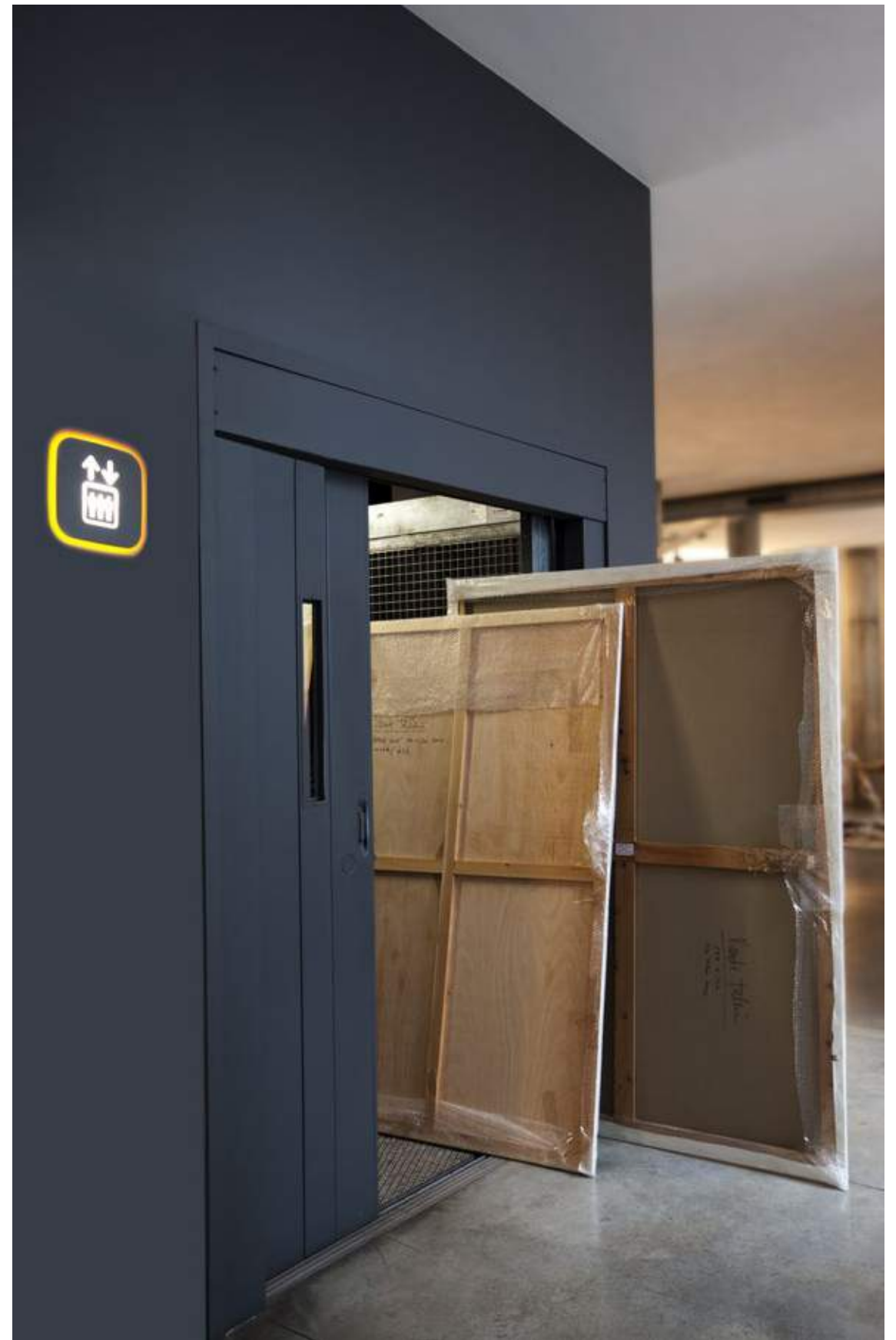

495



Wall Rupture es una luminaria invisible realizada en Soft Composite. El efecto es como de un pliegue secreto en la pared que oculta el relieve irregular de la tierra. Disponible en color oro y plata. Incorpora tiras de LED con diferentes temperaturas de color: 2700K (versión decorado oro) ó 5000K (versión decorado plata).

WALL RUPTURE

Wall Rupture is an invisible luminaire made of Soft Composite. The effect is like a secret fold in the wall that conceals the irregular relief of the earth. Available in gold and silver. It incorporates LED strips with different colour temperatures: 2700K (gold version) or 5000K (silver version).

LINEAR / WALL RUPTURE

LINEAR / WALL RUPTURE

WALL RUPTURE

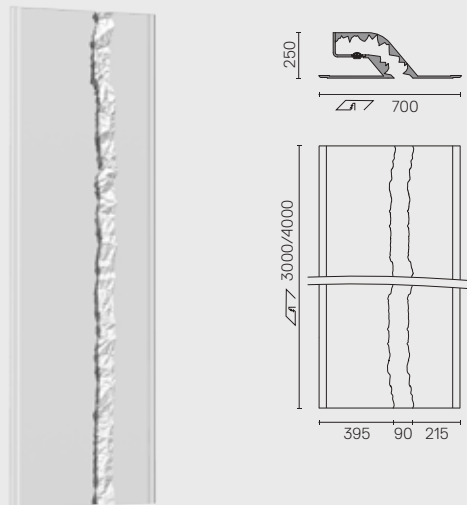

WALL RUPTURE WITH ENDCAPS

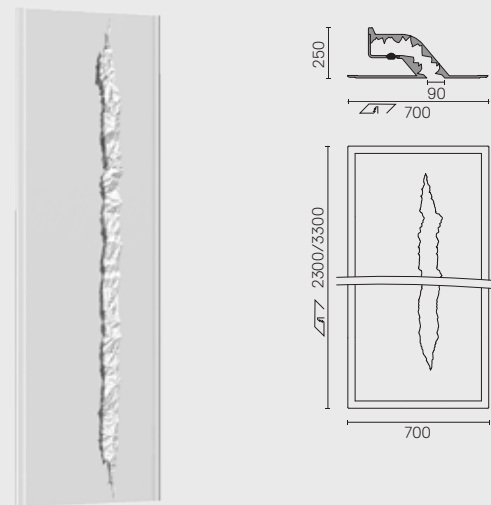

Luminaria empotrada para instalación a pared de tecnología Soft. Módulos de LED de diferente temperatura de color según el decorado y equipos no dimables incluidos.

Soft technology wall-mounted, recessed luminaire. LED modules to emit lights with different colour temperature depending on décor; non-dimmable gear included.

Premios Awards

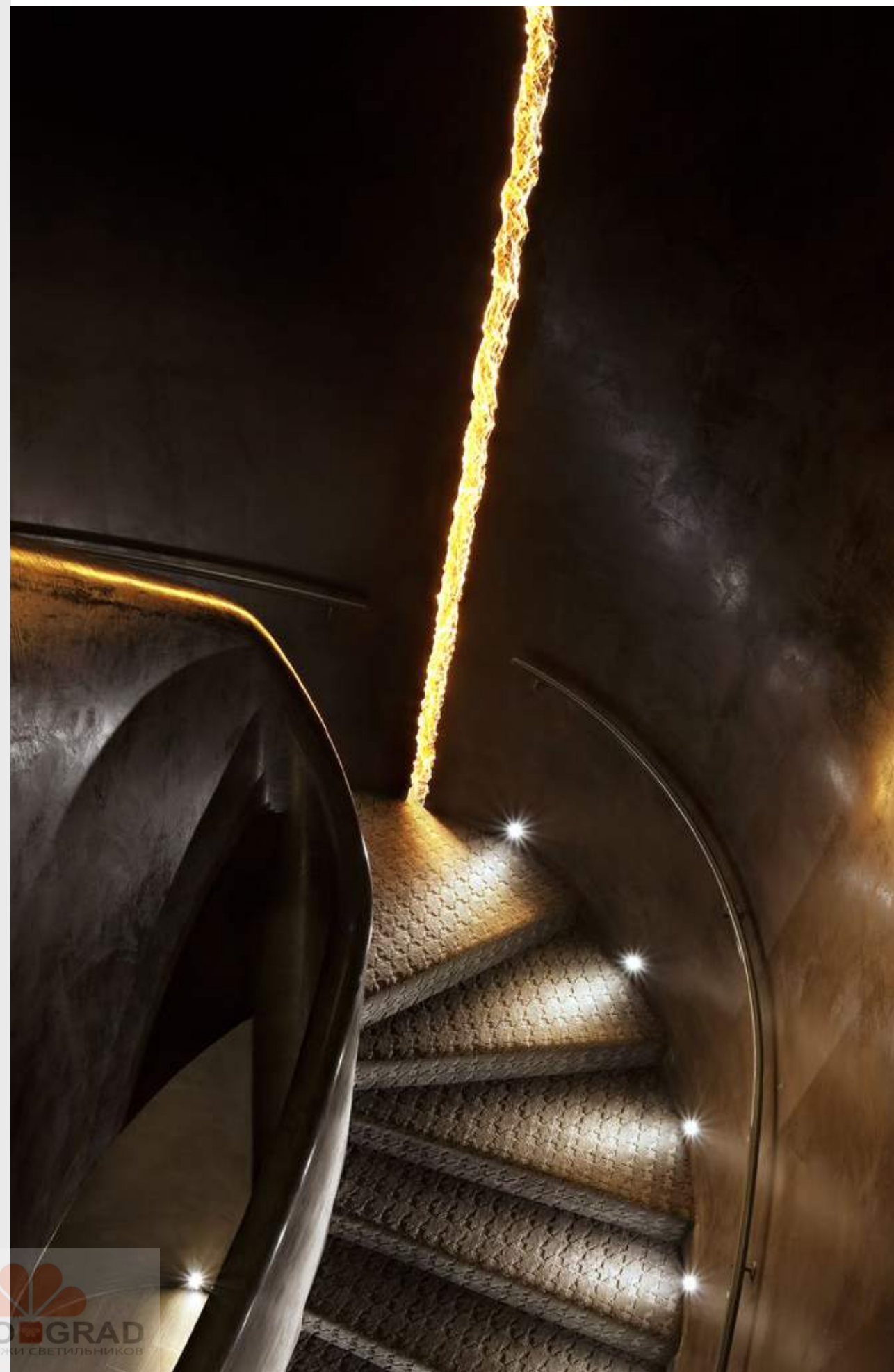



FLOS SHOWROOM - SPAIN

Familia de luminarias realizadas con la tecnología Soft Composite e ideadas para albergar proyectos de FLOS arquitectural. Disponible en varios tamaños y formas así como en versión 1L y 2L, la familia Uso ofrece una gran variedad de soluciones de iluminación, asegurando siempre la total integración en el espacio arquitectural.

USO

Family of luminaires manufactured with Soft Composite technology and designed to house FLOS architectural project. Available in several sizes and shapes, as well as in 1L and 2L versions, the Uso family offers a wide variety of lighting solutions, always guaranteeing total integration into the architectural space.

USO KAP 105

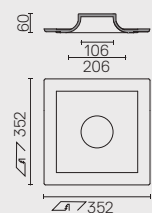
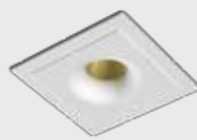

USO KAP 145

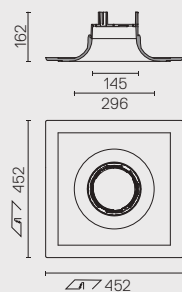
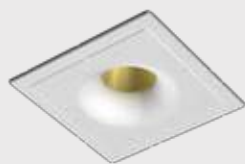

USO 332

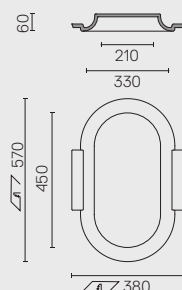

Aplicación arquitectónica de tecnología Soft que permite una perfecta integración de los productos Flos arquitectural.
Para una configuración personal, puede añadir puntos de luz en la estructura. Consultar al equipo de ventas de Flos arquitectural.

Soft technology architectonic application that permits perfect integration of the Flos architectural products.
For personal configuration, you can add light points in the structure. Ask Flos architectural sales team.

USO 330 FOR MODULAR CEILING

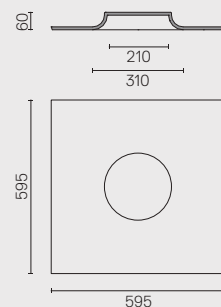
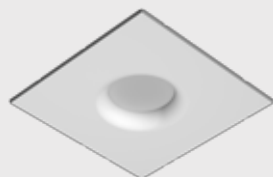

USO 332 FOR MODULAR CEILING

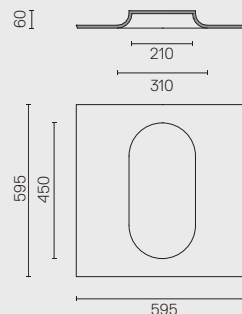
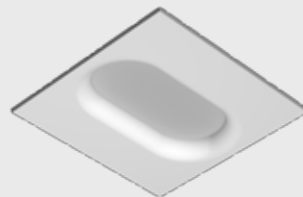

Aplicación arquitectónica de tecnología Soft para techos modulares que permite una perfecta integración de los productos Flos arquitectural.
Para una configuración personal, puede añadir puntos de luz en la estructura. Consultar al equipo de ventas de Flos arquitectural.

Soft technology architectonic application for modular ceilings that permits perfect integration of the Flos Architectural products.
For personal configuration, you can add light points in the structure. Ask Flos architectural sales team.

USO 400

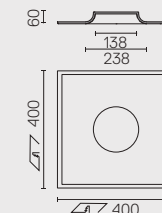
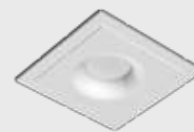

USO 600

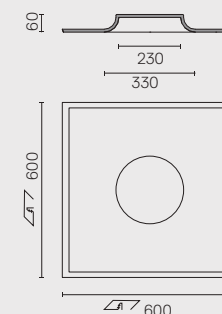
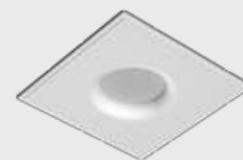

USO 600 FOR MODULAR CEILING

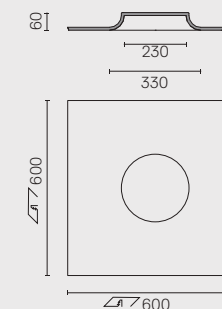
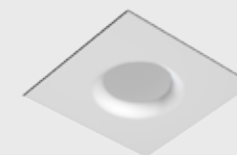

Aplicación arquitectónica de tecnología Soft que permite una perfecta integración de los productos Flos arquitectural.
Para una configuración personal, puede añadir puntos de luz en la estructura. Consultar al equipo de ventas de Flos arquitectural.

Aplicación arquitectónica de tecnología Soft para techos modulares que permite una perfecta integración de los productos Flos arquitectural.
Para una configuración personal, puede añadir puntos de luz en la estructura. Consultar al equipo de ventas de Flos arquitectural.

USO 500

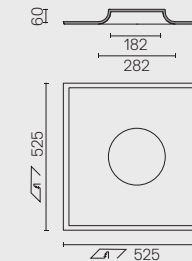
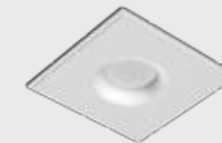

USO 700

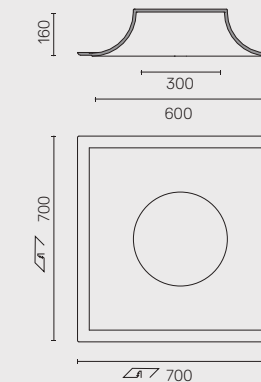
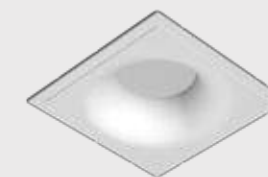

Soft technology architectonic application that permits perfect integration of the Flos architectural products.
For personal configuration, you can add light points in the structure. Ask Flos architectural sales team.

Soft technology architectonic application for modular ceilings that permits perfect integration of the Flos architectural products.
For personal configuration, you can add light points in the structure. Ask Flos architectural sales team.

IN / USO

IN / USO

USO 800

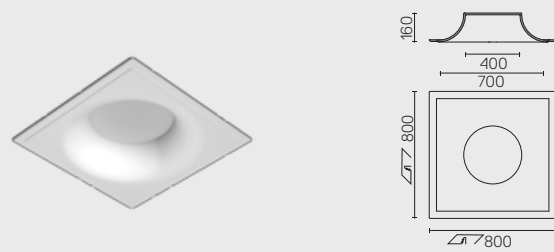

USO 1000

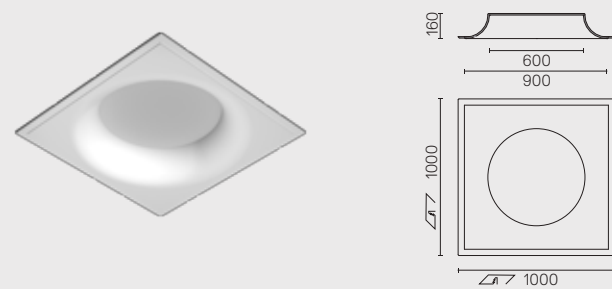

USO 1400

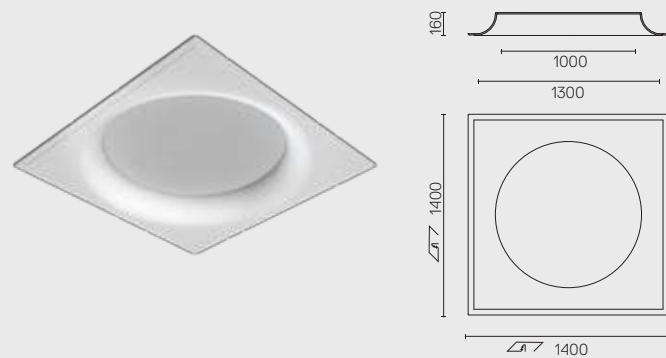

Aplicación arquitectónica de tecnología Soft que permite una perfecta integración de los productos Flos arquitectural.

Para una configuración personal, puede añadir puntos de luz en la estructura. Consultar al equipo de ventas de Flos arquitectural.

Soft technology architectonic application that permits perfect integration of the Flos architectural products.

For personal configuration, you can add light points in the structure. Ask Flos architectural sales team.



SEO TOKIO HOTEL - JAPAN

SHOWROOM - U.S.A.



510

DANIELA HOTEL - ITALY



511

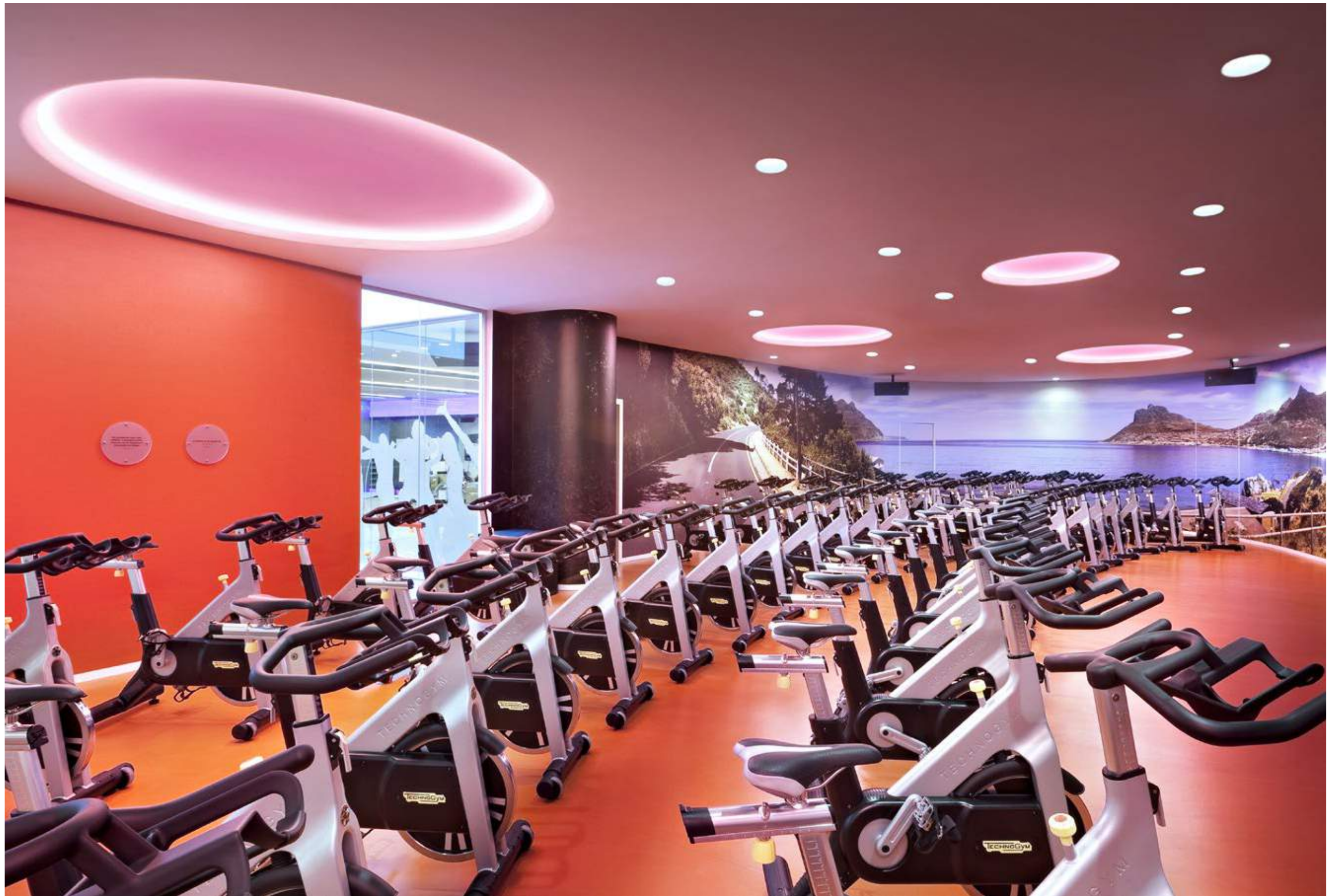

USO 900 COVE LIGHTING



USO 1700 COVE LIGHTING

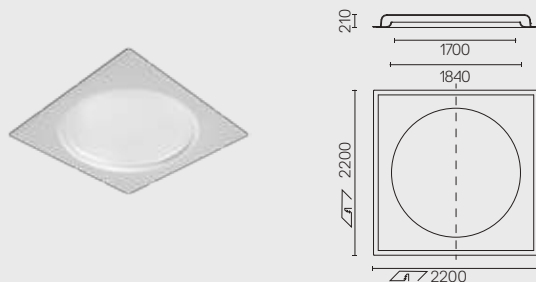

USO 2200 COVE LIGHTING

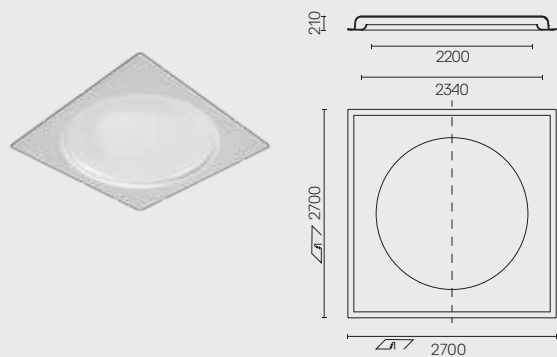

USO 2500 COVE LIGHTING

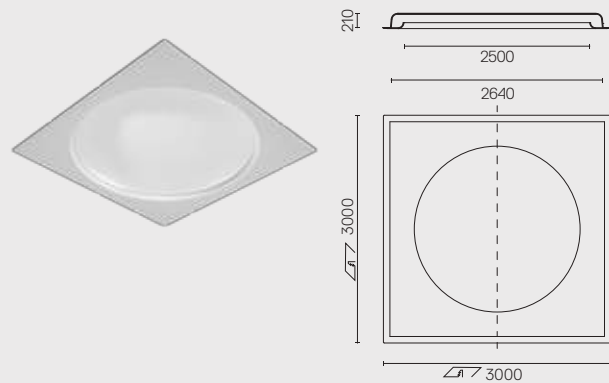

USO 100 50 COVE LIGHTING



USO 140 90 COVE LIGHTING



Luminaria empotrada para ser instalada a techo o pared. Iluminación directa con lámparas de fluorescencia, cátodo frío o LED. Equipos no incluidos en las versiones LED.

Recessed ceiling or wall-mounted luminaire. Direct lighting with fluorescent, cold cathode or LED lamps. Control gear not included in LED versions.



SEO TOKIO HOTEL - JAPAN

RNB HEADQUARTERS - SPAIN



516

LAWYERS OFFICE - ITALY

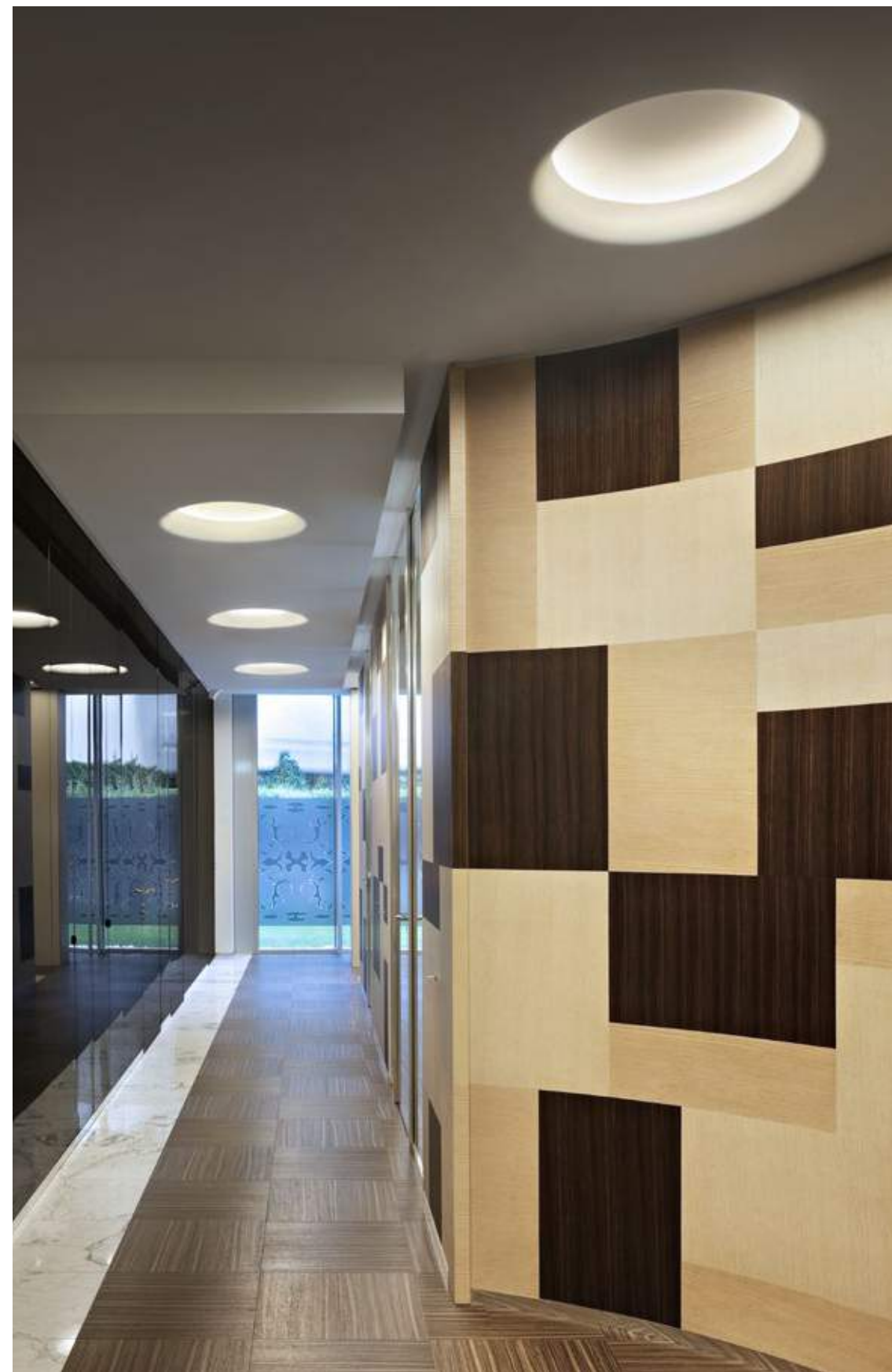

517

PRIVATE OFFICES - BELGIUM



518

LAWYERS OFFICE - ITALY



519

Lámpara LED de pared diseñada para un mínimo impacto visual integrada en la pared. Instalación enrasada a pared de yeso o escayola. Aro realizado en aluminio con difusor de policarbonato. Instalación eléctrica rápida con conectores hembra y ganchos de plástico para una fácil instalación.

WALL PIERCING

LED wall lamp designed for minimal visual impact integrated into wall. Flush-mounted on plasterboard wall. Aluminium ring with polycarbonate diffuser. Fast electrical installation with female connectors and plastic hooks for easy installation.



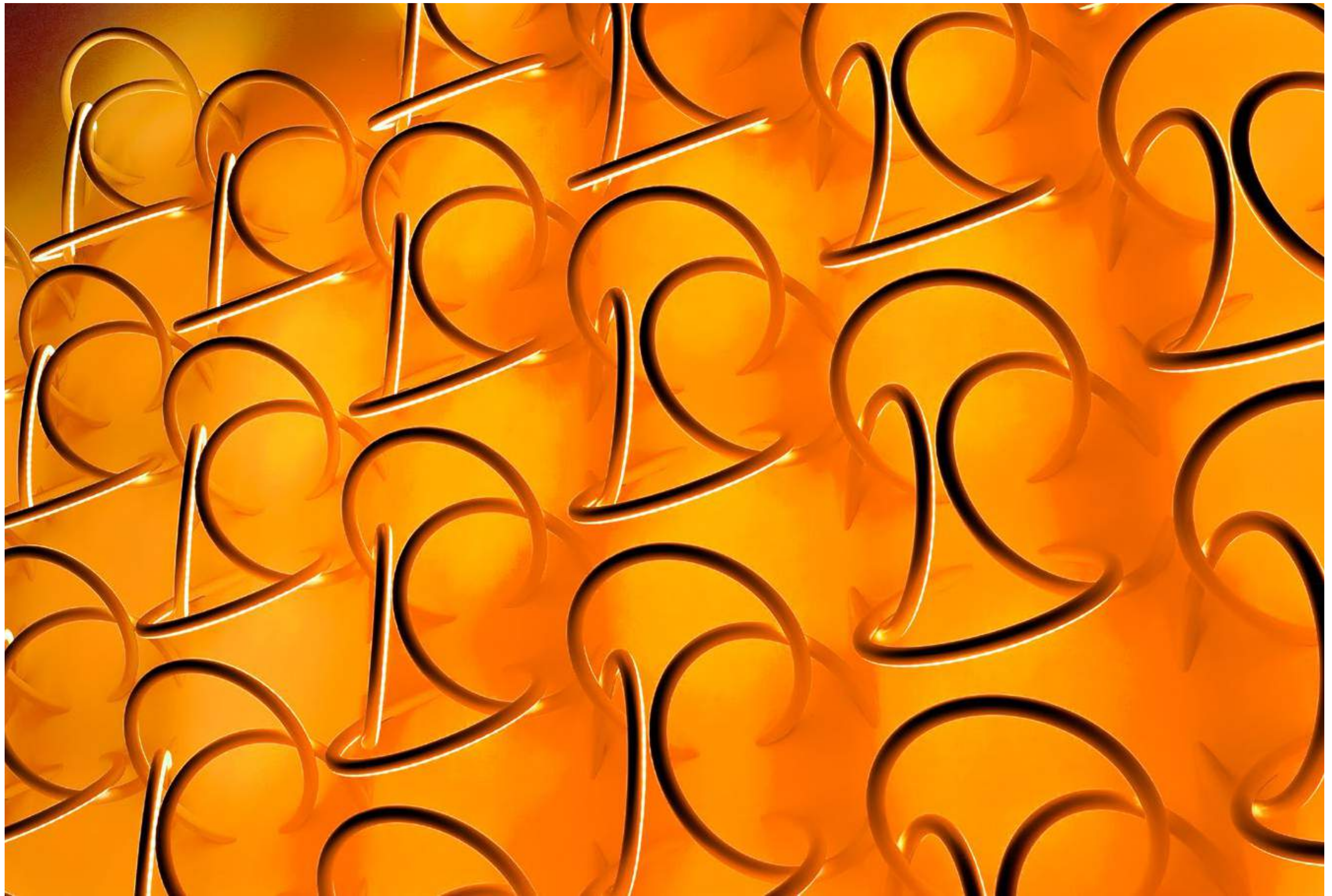

WALL PIERCING 1X

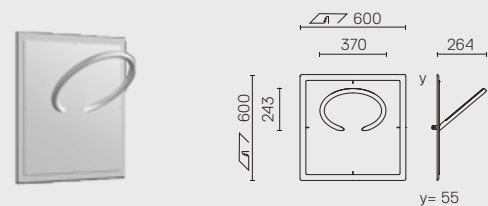

WALL PIERCING 2X

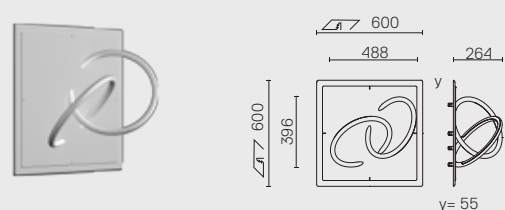

WALL PIERCING 4X

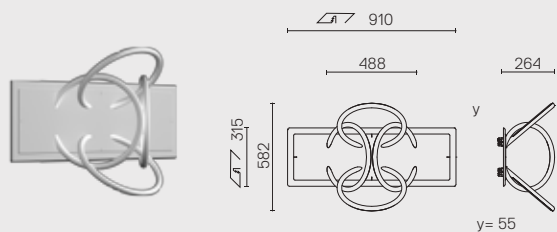

WALL PIERCING 2X LINE

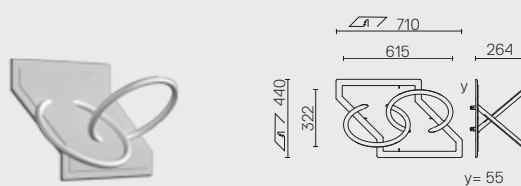

Luminaria semi-empotrada para ser instalada a techo o pared. Disponible en versiones de LED blanco o RGB. Equipo y controladores no incluidos.

Soft technology semi-recessed luminaire for ceiling or wall mounting. Available in white LED or RGB versions. Control gear not included.

Premios Awards



EUROLUCE FAIR - ITALY

FLOS SHOWROOM - ITALY



526

FLOS SHOWROOM - ITALY



527

Iluminación realizada en Soft Composite inspirada en la geometría de un volcán invertido. Disponible en dos tamaños y en versión 1 / 2 focos. Uso Boob esta específicamente diseñado para albergar los productos FLOS arquitectural.

USO BOOB

Lighting made of Soft Composite inspired by the geometry of an inverted volcano. Available in two sizes and in 1 / 2 spot version. Uso Boob is specifically designed to house FLOS architectural products.



FLOS SHOWROOM - ITALY

USO BOOB 600 1L

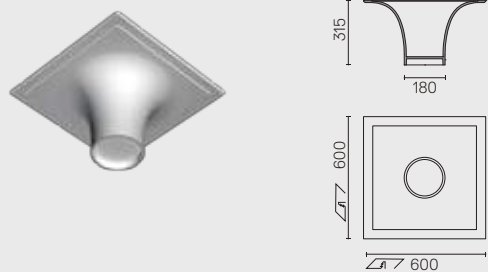

USO BOOB 600 2L

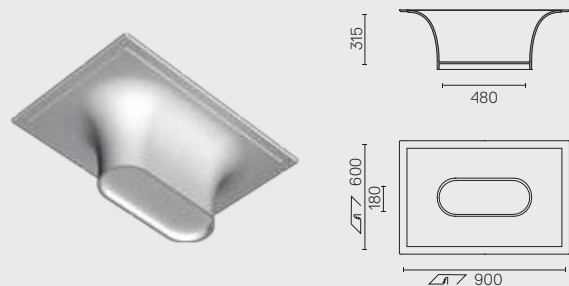

Aplicación arquitectónica de tecnología Soft que permite una perfecta integración de los productos Flos arquitectural.
Para una configuración personal, puede añadir puntos de luz en la estructura. Consultar al equipo de ventas de Flos arquitectural.

Soft technology architectonic application that permits perfect integration of the Flos architectural products.
For personal configuration, you can add light points in the structure. Ask Flos architectural sales team.

USO BOOB 600 FOR MODULAR CEILING

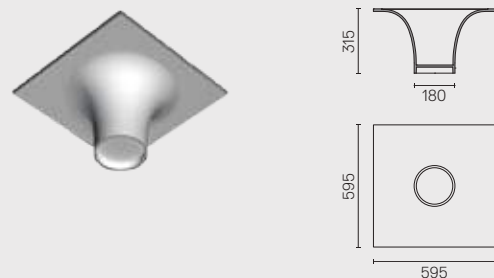

Aplicación arquitectónica de tecnología Soft para techos modulares que permite una perfecta integración de los productos Flos arquitectural.
Para una configuración personal, puede añadir puntos de luz en la estructura. Consultar al equipo de ventas de Flos arquitectural.

Soft technology architectonic application for modular ceilings that permits perfect integration of the Flos architectural products.
For personal configuration, you can add light points in the structure. Ask Flos architectural sales team.

USO BOOB 100 1L

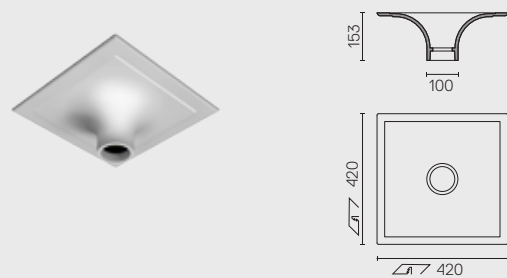

Luminaria empotrable para lámpara halógena de 12V. Transformador remoto no incluido.

Recessed luminaire for 12V halogen lamp. Remote transformer not included.

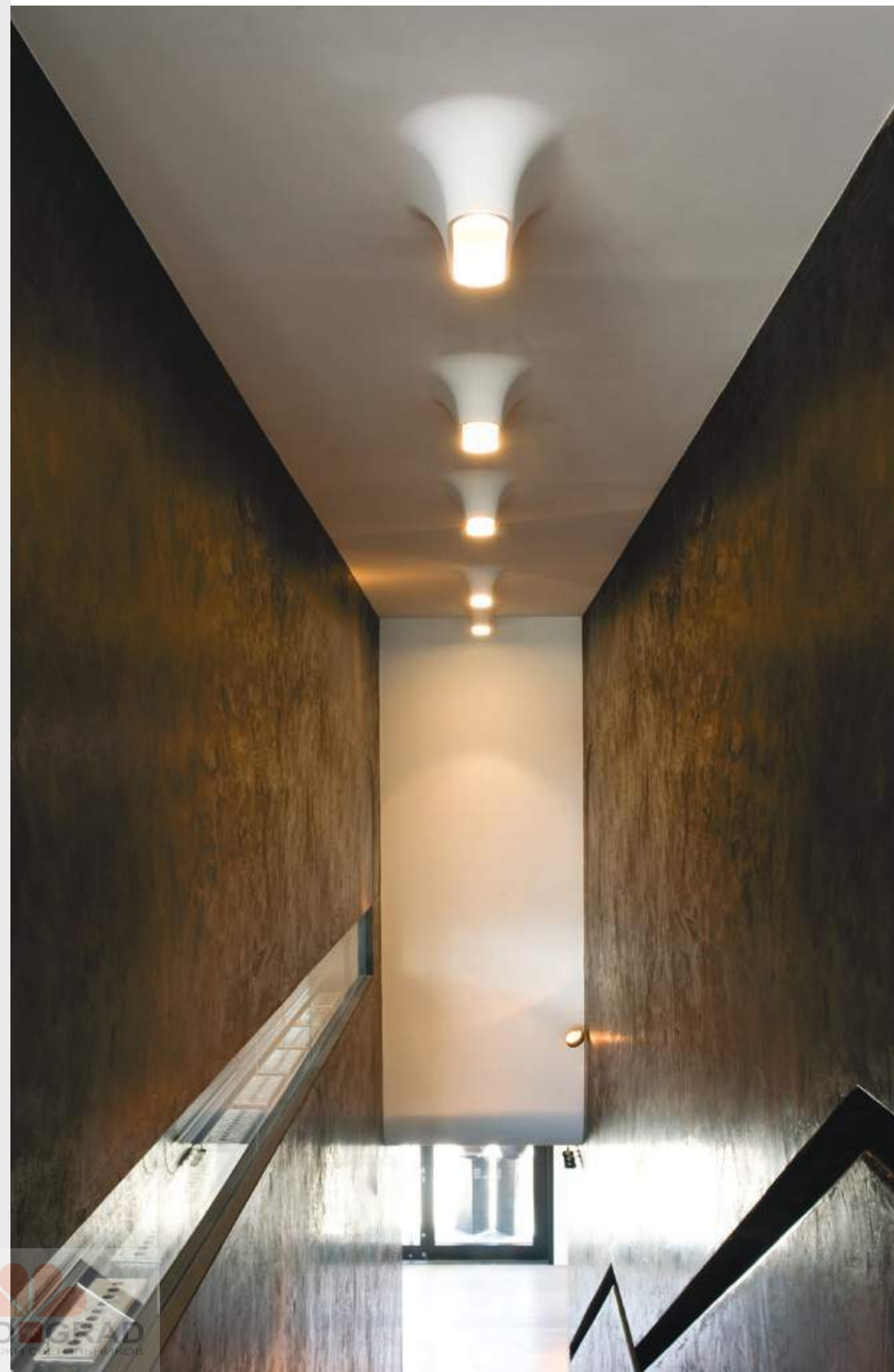



Luminaria LED para pared, específicamente diseñada para la señalización de interiores tales como pasillos, escaleras, etc. Diseñada en tecnología Soft Composite, se integra perfectamente en el espacio arquitectural. Disponible en luz blanca, ámbar o azul, según necesidades del proyecto de iluminación.

G-O IN

LED wall luminaire, specifically designed for indoor signage of corridors, stairs, etc. Fitting combined with Soft Composite technology integrates perfectly into the architecture. Available with white, amber or blue light depending on the needs of the lighting project.

IN / G-O IN

IN / G-O IN

G-O IN

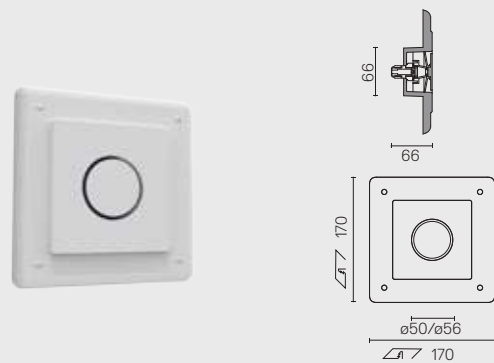

Luminaria empotrada de señalización para aplicación interior. Fuente de alimentación no incluida. Incluye cable de alimentación de 1000mm.

Recessed sign luminaire for indoor application. Power supply source not included. It includes 1000mm power supply cable.

Colores de la Luz
Lighting Colours

Blanco
White

Ámbar
Amber

Azul
Blue



Premios
Awards



reddot design award
winner 2013



PRIVATE HALL ENTRANCE - SPAIN

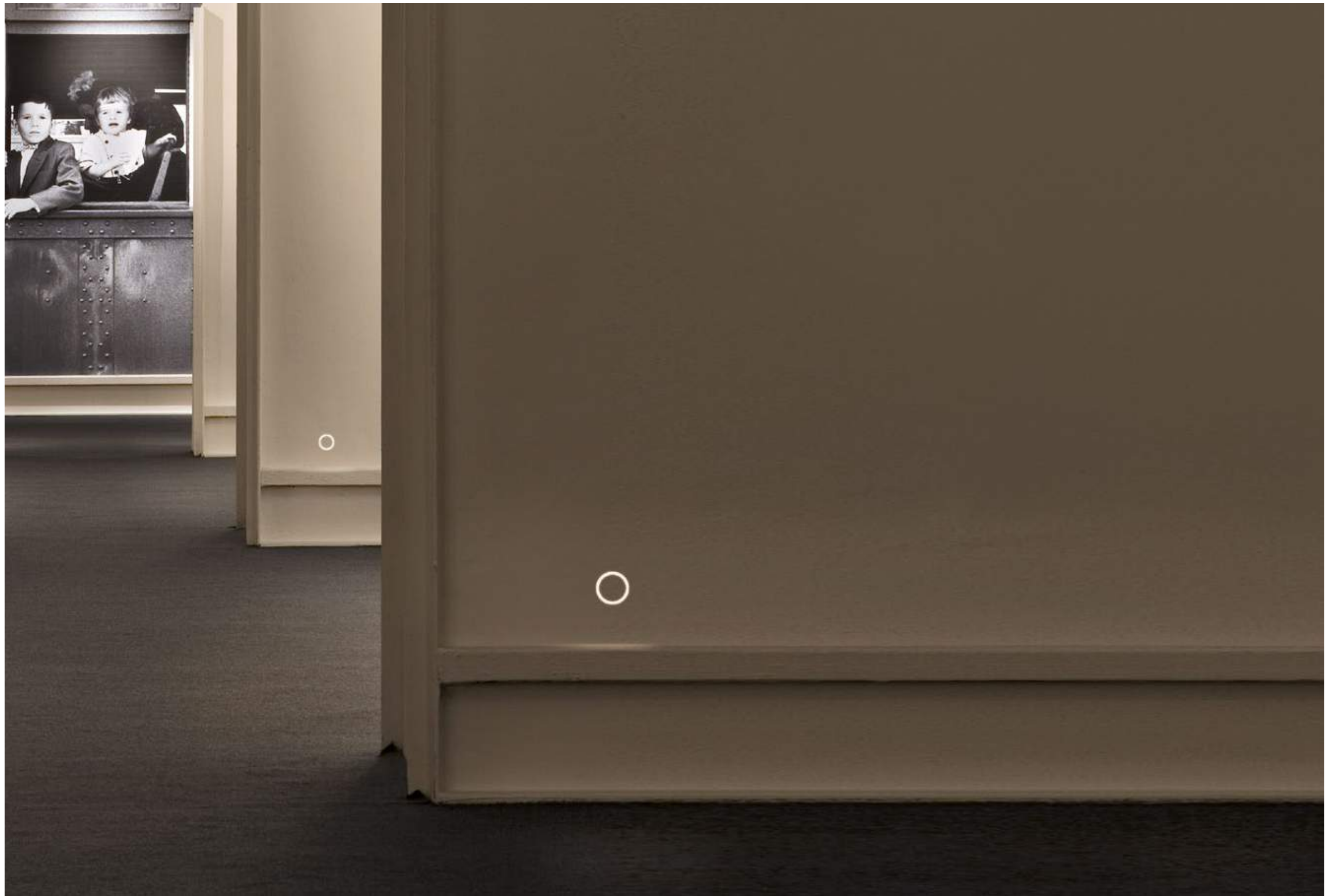

MUSEUM - ITALY

Lámpara diseñada para un mínimo impacto visual que se instala enrasada a pared de placas de yeso o escayola. Disponible con fuentes de luz halógena directa a red, fluorescente y LED. Todas ellas incluyen cristal de seguridad ópalo.

SOFT SPUN

Lamp designed for minimal visual impact that is flush mounted to plasterboard walls. Available with halogen light sources connected directly to mains, fluorescent and LED lights sources. All of them include opal safety glass.

SOFT SPUN HALOGEN SMALL

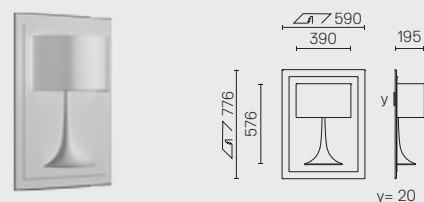

Luminaria empotrable para lámpara halógena directa a red.

SOFT SPUN HALOGEN LARGE

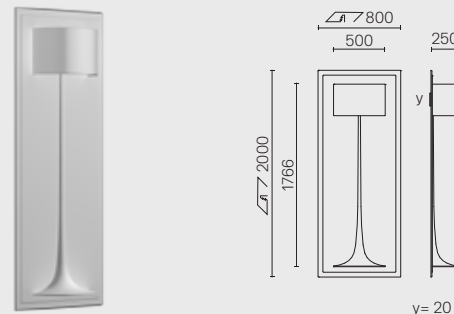

Recessed luminaire for halogen lamp, direct connection to mains.

SOFT SPUN FLUORESCENT SMALL

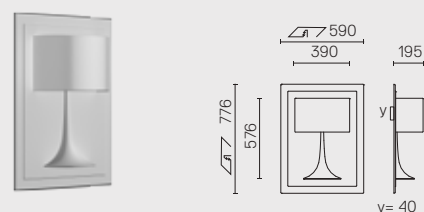

Luminaria empotrable para lámpara fluorescente. Balastos 220/240V no dimables incluidos.

SOFT SPUN FLUORESCENT LARGE

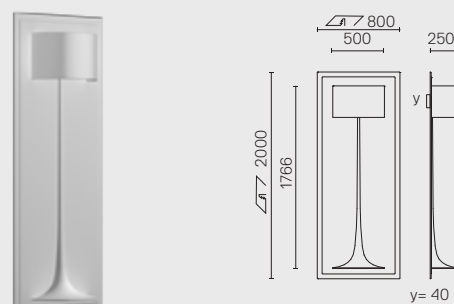

Recessed luminaire for fluorescent lamp non-dimmable 220/240V ballasts included.

SOFT SPUN LED SMALL

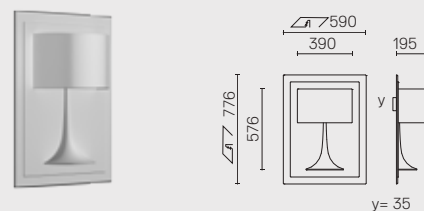

Luminaria empotrable para lámpara LED. Alimentador 220/240V no dimable incluido.

SOFT SPUN LED LARGE

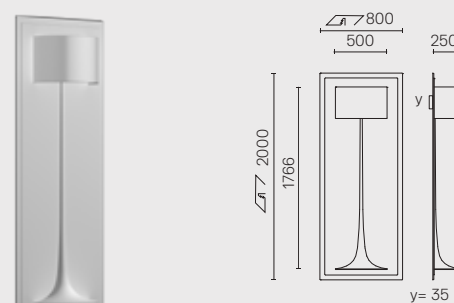

Recessed luminaire for LED lamp. Non-dimmable 220/240V power supply included.



PRIVATE HOUSE - ITALY

PRIVATE HOUSE - ITALY



546

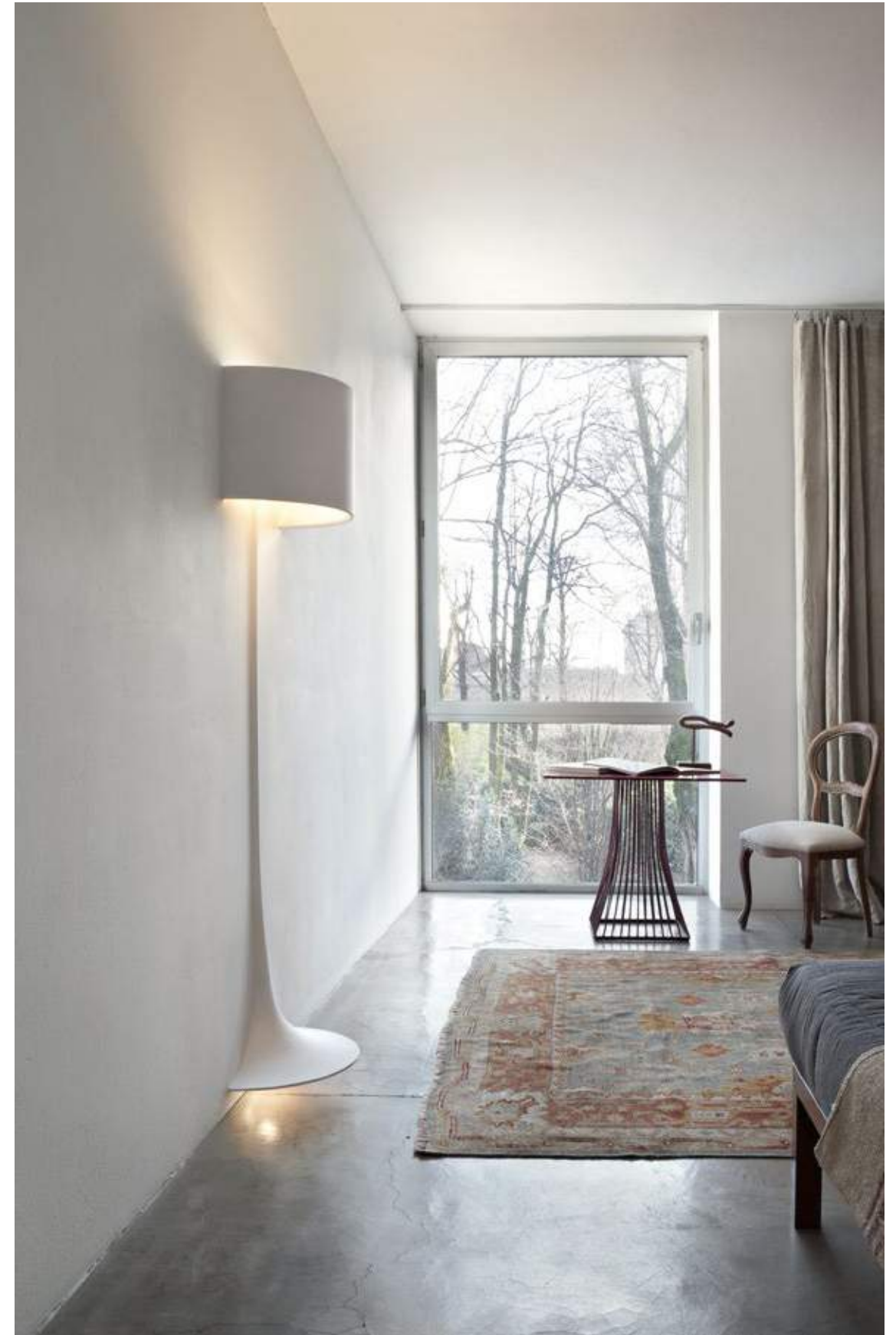

PRIVATE HOUSE - ITALY

547



VIRGIN ACTIVE - PORTUGAL

Lámpara diseñada para un mínimo impacto visual que se instala enrasada a pared de placas de yeso o escayola. Disponible con fuentes de luz halógena directa a red, fluorescente y LED. Todas ellas incluyen cristal de seguridad ópalo.

ABAJOURD'HUI

Lamp designed for minimal visual impact that is flush mounted to plasterboard walls. Available with halogen light sources connected directly to mains, fluorescent and LED lights sources. All of them include opal safety glass.



ABAJOURD'HUI SMALL

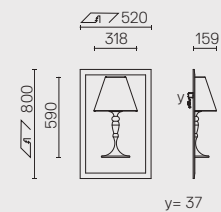

Luminaria empotrable de alimentación directa a red.

ABAJOURD'HUI LARGE

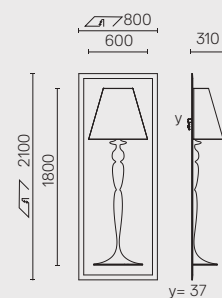

Recessed luminaire with direct connection to mains.





ARANCIO AMARO HOTEL - ITALY

556



VERBANO HOTEL - ITALY

557

Downlight redondo disponible en varios diámetros diseñado para un mínimo impacto visual realizado en escayola. La fuente de luz queda instalada en una posición profunda, para conseguir un alto confort visual. Instalación en techo realizado con placas de yeso o escayola.

TEARDROP

Round downlight available in several diameters designed for minimal visual impact made of plaster. The light source is installed in a deep position, to achieve high visual comfort.

Plasterboard ceiling-mounting.



IN / TEARDROP

IN / TEARDROP

TEARDROP SMALL

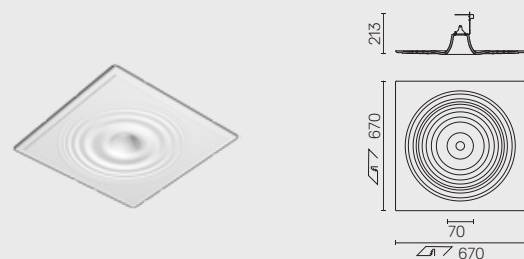

Luminaria empotrable para lámpara halógena de 12V. Transformador remoto no incluido.

Recessed luminaire for 12V halogen lamp. Remote transformer not included.

TEARDROP MEDIUM

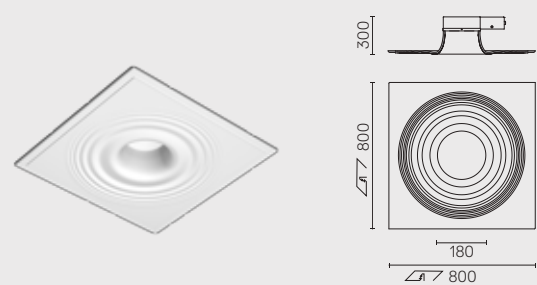

Luminaria empotrable para lámpara fluorescente. Balastos no dimables incluidos.

TEARDROP LARGE

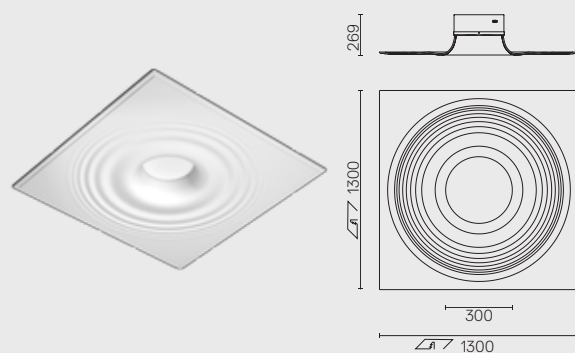

Recessed luminaire for fluorescent lamp non-dimmable ballasts included.





FLOW SHOWROOM - MALTA

Luminaria en suspensión para interiores realizada en Soft Composite. Con un innovador diseño orgánico, puede albergar tanto fuentes de luz halógenas, para iluminación directa, como de fluorescencia, para iluminación indirecta.

BENGUERRA

Suspended luminaire for indoor use, made in Soft Composite. With an innovative organic design, it can house both halogen light sources, for direct lighting, and fluorescent, for indirect lighting.

BENGUERRA SQUARE

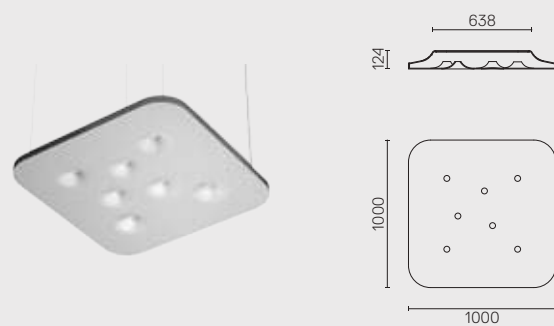

Sistema de iluminación directa/indirecta para ser instalado a techo. Iluminación directa con lámparas halógenas de 12V e indirecta con lámparas fluorescentes. Equipos no dimables incluidos.

Direct/indirect ceiling-mounted lighting system. Direct lighting with 12V halogen lamps and indirect lighting with fluorescent lamps. Non-dimmable gear included.



El grupo lumínico USL 3D, 111 & Pluto engloba un conjunto de luminarias en suspensión para interiores realizadas en Soft Composite. Ofrece gran versatilidad ya que, según modelos, pueden incorporar tanto fuentes de luz ambiental como de acento.

USL

The USL 3D, 111 & Pluto luminous group encompasses a series of suspended luminaires for indoor use, made of Soft Composite. It offers great versatility as, depending on models, they can incorporate both ambient light sources and accent light sources.

USL 800

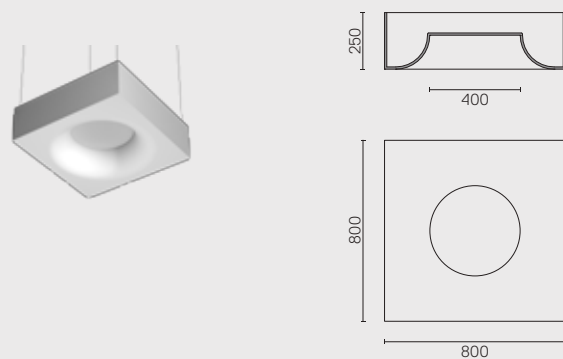

USL 1000

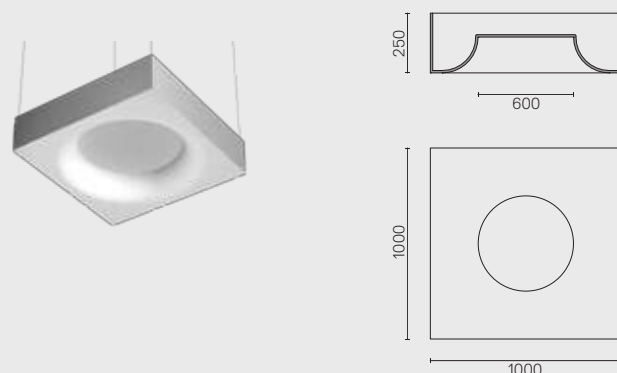

USL 1400

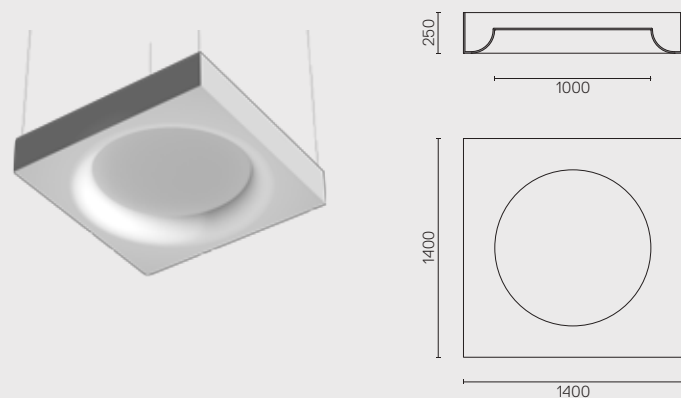

Sistema de iluminación indirecta para ser instalado a techo. Iluminación indirecta con lámparas fluorescentes lineales. Permite instalar producto Flos architectural.

Indirect ceiling-mounted lighting system. Indirect lighting for linear fluorescent lamps. It permits installation of Flos architectural product.

USL 160 71

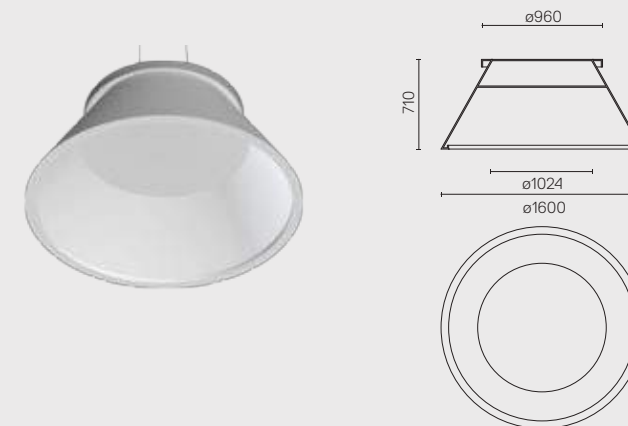

Sistema de iluminación directa para ser instalado a techo. Permite instalar producto Flos architectural.

Direct ceiling-mounted lighting system. It permits installation of Flos architectural product.

SOFT ARCHITECTURE: 3D / USL 111

USL 111 SUSPENSION



Sistema de iluminación directa para ser instalado a techo. Iluminación con lámpara de LED directa a red 220-240V.

Direct ceiling-mounted lighting system. Lighting with LED lamp, direct connection to 220-240V mains.

USL 111 RECESSED

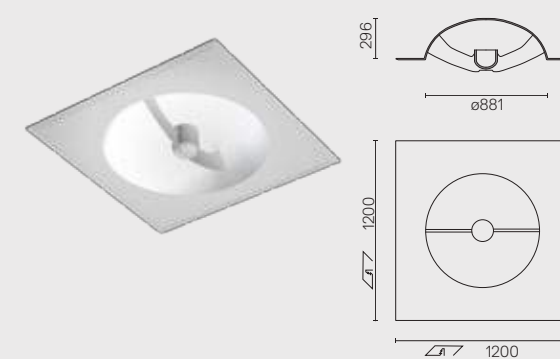

Luminaria empotrada de tecnología Soft. Iluminación con lámpara de LED directa a red 220-240V.

Soft technology recessed luminaire. Lighting with LED lamp, direct connection to 220-240V mains.

3D / USL PLUTO

3D / USL PLUTO

USL 100 PLUTO

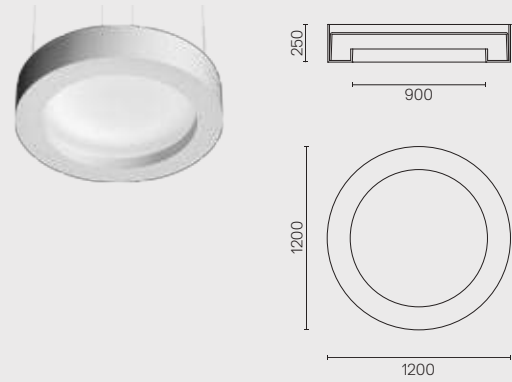

USL 200 PLUTO

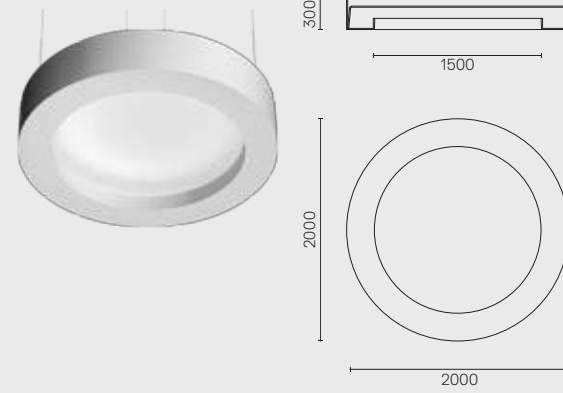

Sistema de iluminación directa para ser instalado a techo. Iluminación directa con lámparas de fluorescencia, cátodo frío o LED. Equipos no incluidos en las versiones LED.

Direct ceiling-mounted lighting system. Direct lighting with fluorescent, cold cathode or LED lamps. Control gear not included in LED versions.





CEGEKA HEADQUARTERS - BELGIUM

Aparato de iluminación empotrable para instalación en pared/techo de interiores. Disponible en versión redondo/cuadrado/rectangular. Diseñado para fundirse con el entorno y generar un mínimo impacto visual, la familia Round, Square & Vertical Light incorpora una pantalla integrada en su interior y una lente difusora realizada en policarbonato.

ROUND, SQUARE & VERTICAL LIGHT

Recessed light fitting for interior wall and ceiling mounting. Available in round/square/rectangular versions. Designed to blend in with the surroundings and generate minimal visual impact, the Round, Square & Vertical Light family incorporates a screen on the inside as well as diffuser polycarbonate lens.

IN / ROUND LIGHT

ROUND LIGHT SMALL

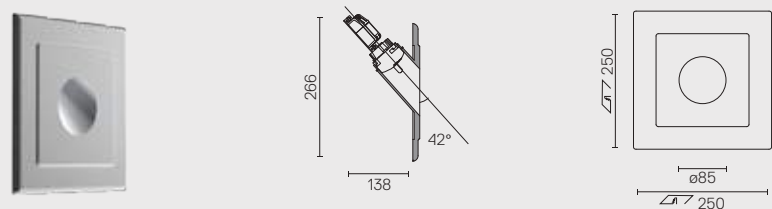

ROUND LIGHT MEDIUM

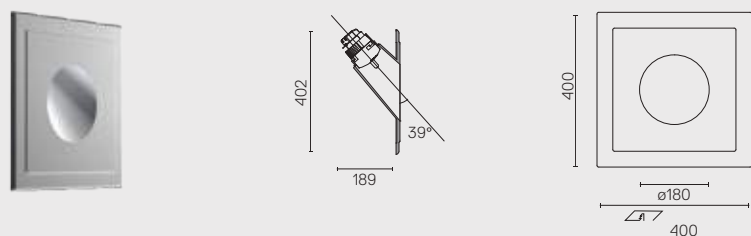

ROUND LIGHT LARGE

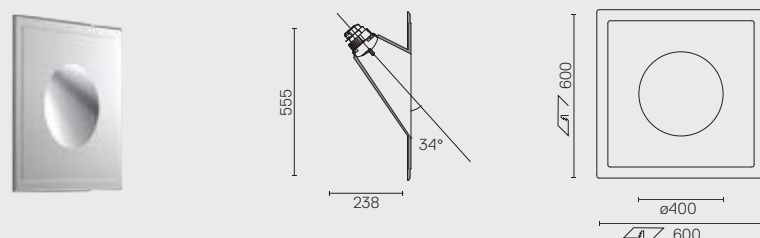

Luminaria empotrada de señalización para aplicación interior. Fuente de alimentación 100/240V incluida.

Recessed sign luminaire for indoor application. 100/240V power supply source included.

IN / SQUARE & VERTICAL LIGHT

SQUARE LIGHT SMALL

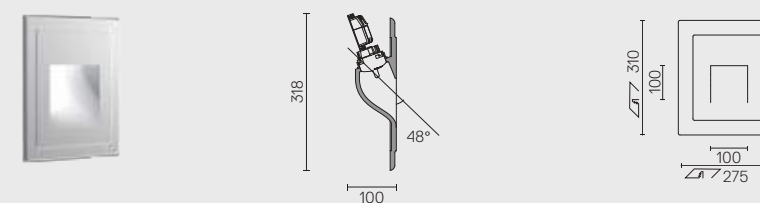

SQUARE LIGHT LARGE

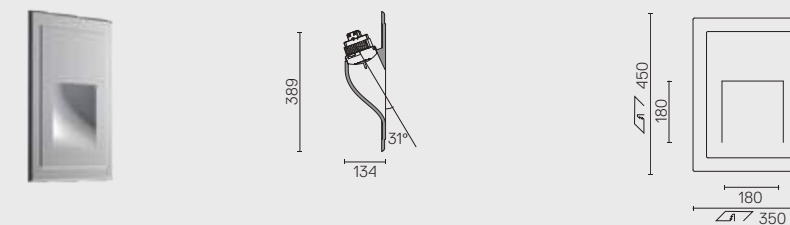

VERTICAL LIGHT SMALL

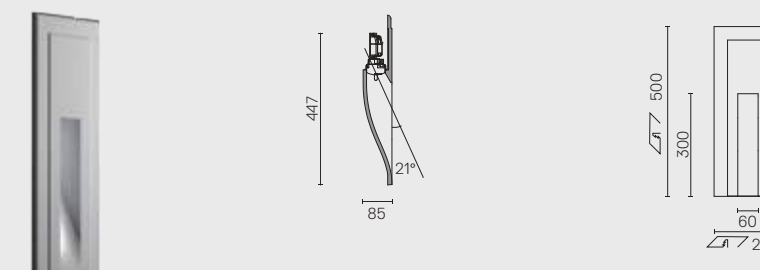

VERTICAL LIGHT LARGE

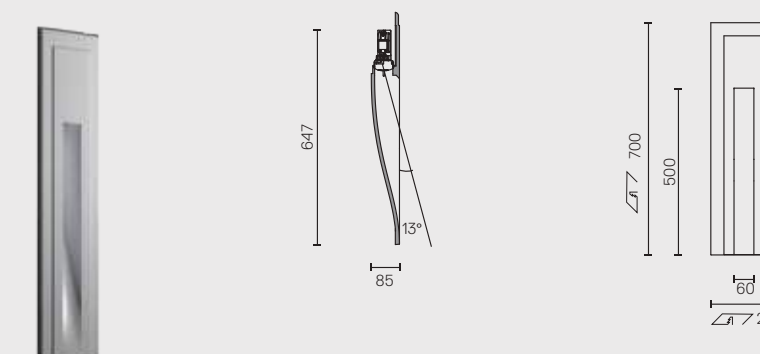

Luminaria empotrada de señalización para aplicación interior. Fuente de alimentación 100/240V incluida.

Recessed sign luminaire for indoor application. 100/240V power supply source included.



IN / SQUARE LIGHT

IN / ROUND LIGHT

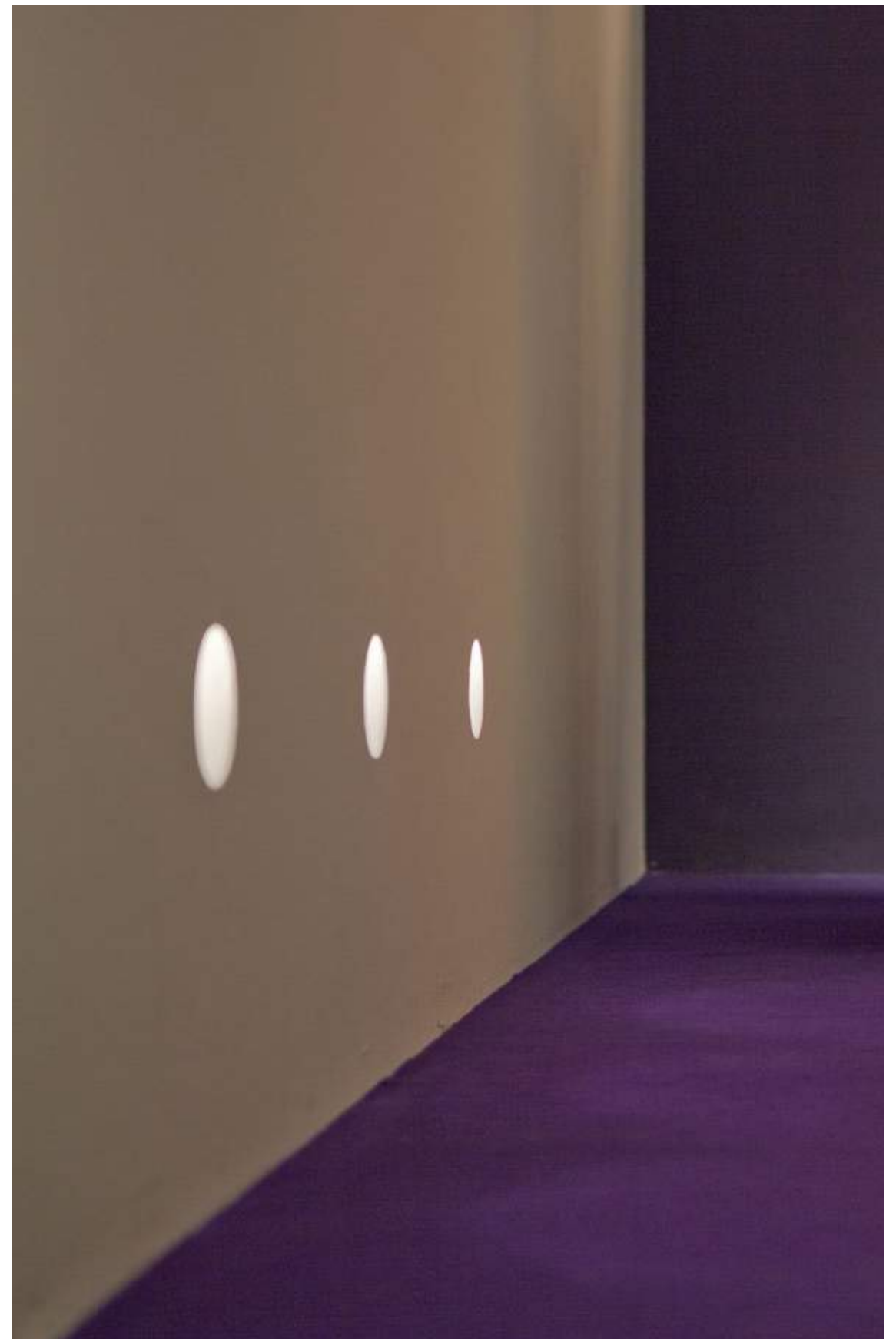

FLOS SHOWROOM - ITALY

PRIVATE OFFICES - SWEDEN

Programa de luminarias downlight empotradas diseñadas para un mínimo impacto visual. Además de estar disponibles en versión redonda y en versión cuadrada, USB Round & Square están en versión de una y dos luces y en versión wall-washer.

USB ROUND & SQUARE LIGHT

Programme of recessed downlight luminaires for minimal visual impact. Apart from being available in round and square versions, USB Round & Square is in one and two light versions and in wall-washer version.

IN / USB ROUND

USB ROUND 1L

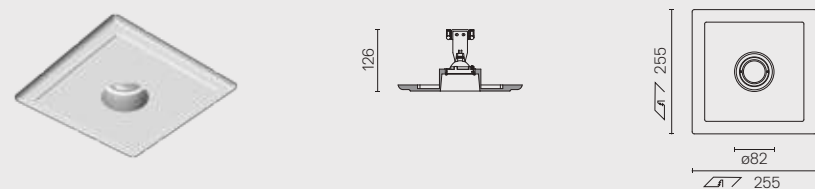

USB ROUND 1L W-W

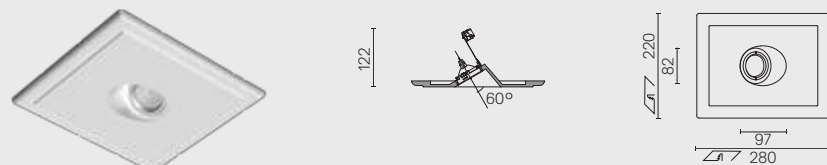

USB ROUND 2L

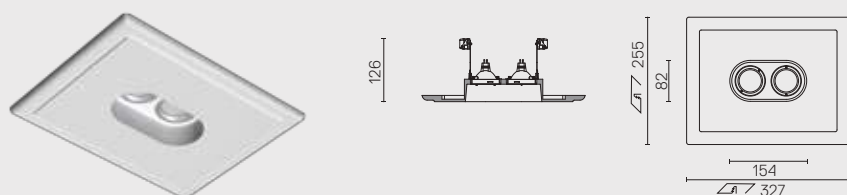

USB ROUND 2L W-W

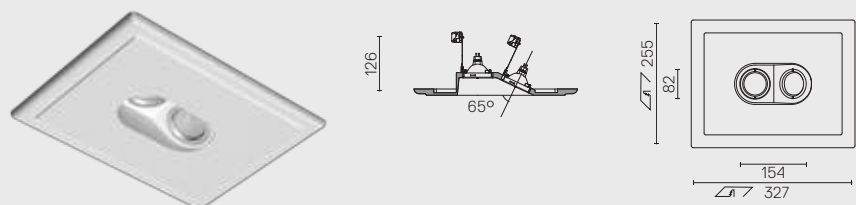

Luminaria empotrable para lámpara halógena de 12V. Transformador remoto no incluido.

Recessed luminaire for 12V halogen lamp. Remote transformer not included.

IN / USB SQUARE

USB SQUARE 1L

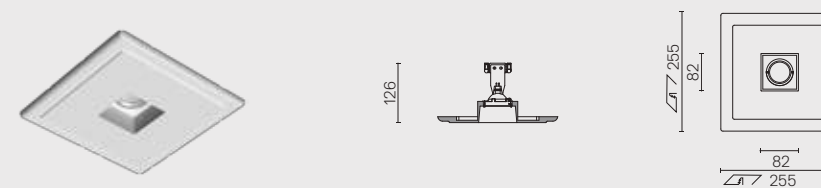

USB SQUARE 1L W-W

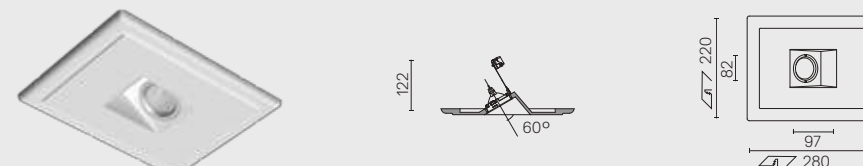

USB SQUARE 2L

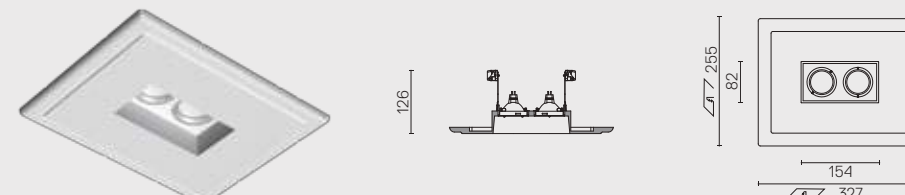

USB SQUARE 2L W-W

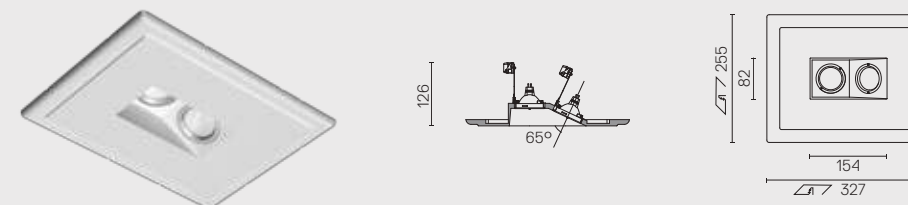

Luminaria empotrable para lámpara halógena de 12V. Transformador remoto no incluido.

Recessed luminaire for 12V halogen lamp. Remote transformer not included.

Luminaria de interiores circular de 210 mm de diámetro realizada en Soft Composite y específicamente diseñada para instalar producto FLOS arquitectural. Usb Box Round combina las altas prestaciones del producto FLOS arquitectural con su completa integración en el espacio mediante la tecnología Soft.

USB BOX

210 mm diameter circular indoor luminaire in Soft Composite and specifically designed to install FLOS architectural product. Usb Box Round combines the high performance of the FLOS architectural product with its total integration into the space by means of Soft technology.

IN / USB BOX

IN / USB BOX

USB BOX ROUND 210

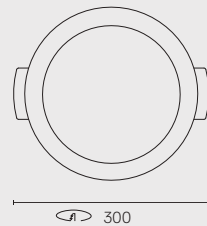
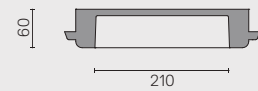

Aplicación arquitectónica de tecnología Soft que permite una perfecta integración de los productos Flos architectural. Para una configuración personal, puede añadir puntos de luz en la estructura. Consultar al equipo de ventas de Flos architectural.

Soft technology architectonic application that permits perfect integration of the Flos architectural products. For personal configuration, you can add light points in the structure. Ask Flos architectural sales team.

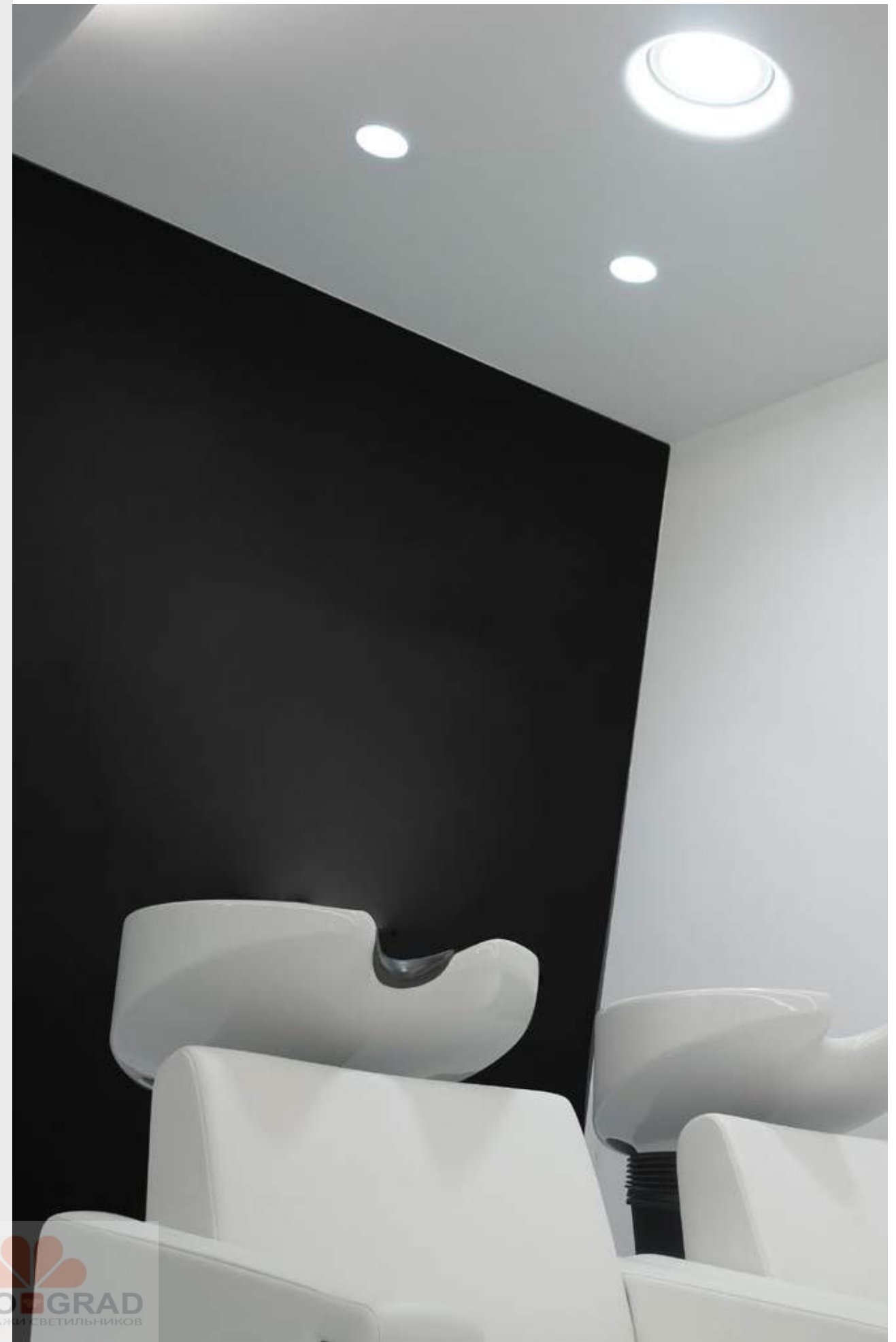

Familia de luminarias que mediante la tecnología Soft Composite se integran perfectamente en el espacio arquitectural. Existen tres versiones: la versión Smooth caracterizada por tener un perfil liso, la versión Starck cuyo perfil está inspirado en la lámpara Long & Hard, y la versión Wanders con perfil inspirado en la lámpara Sky Garden. Las tres versiones pueden ser instaladas tanto a techo como a pared y cuentan con tecnología LED de última generación en color blanco cálido o RGB.

SOFTPROFILE

Family of luminaires that use Soft Composite technology to become perfectly integrated into the architectural space. There are three versions: The Smooth version characterised by its plain profile, the Starck version whose profile is inspired by the Long & Hard lamp, and the Wanders version with profile inspired by the Sky Garden lamp. The three versions can be ceiling and wall mounted, and they have latest generation LED technology in warm white colour or RGB.

SOFTPROFILE SMOOTH SMALL

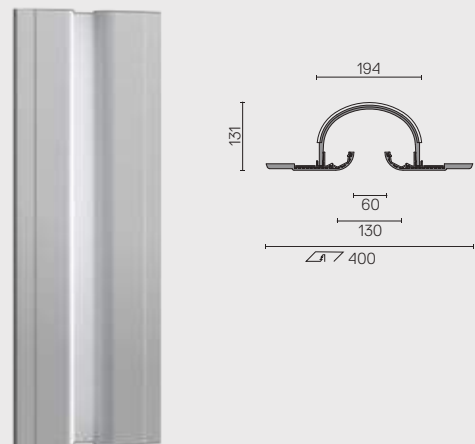

SOFTPROFILE SMOOTH LARGE

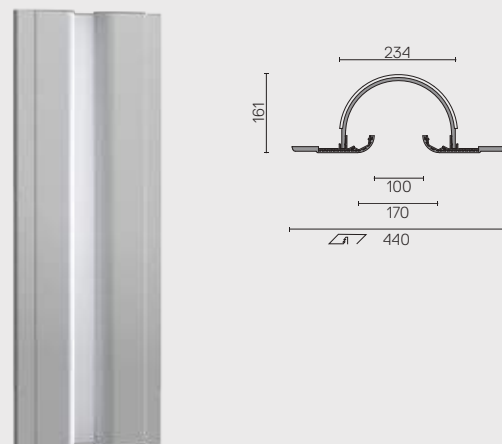

SOFTPROFILE DECO STARCK SMALL

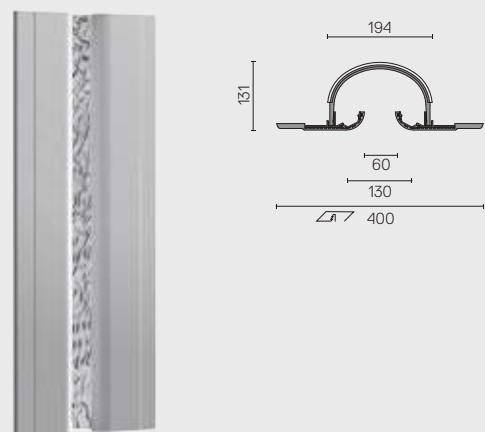

SOFTPROFILE DECO STARCK LARGE

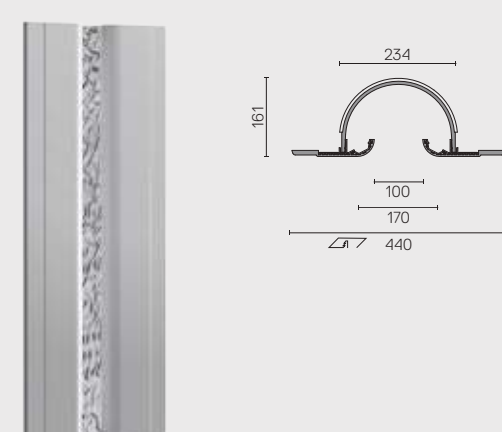

SOFTPROFILE DECO WANDERS SMALL

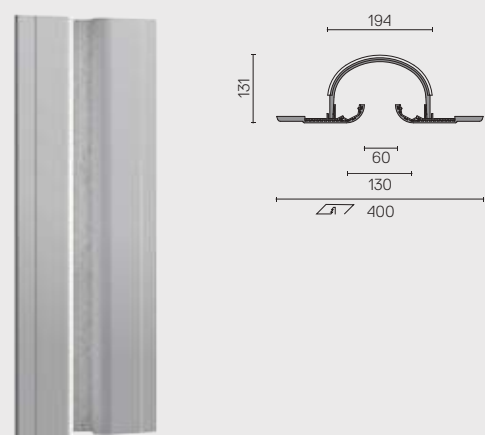

SOFTPROFILE DECO WANDERS LARGE

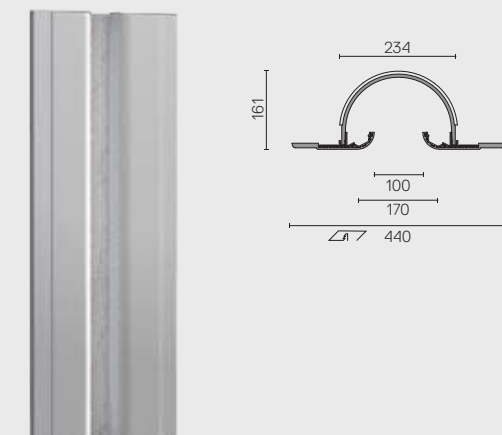

Luminaria empotrada para instalación a pared o techo de tecnología Soft. Permite la instalación de módulos LED en ambos lados. Sistemas de iluminación no incluidos.

Soft technology wall or ceiling-mounted recessed luminaire. It permits the installation of LED modules on both sides. Lighting systems not included.



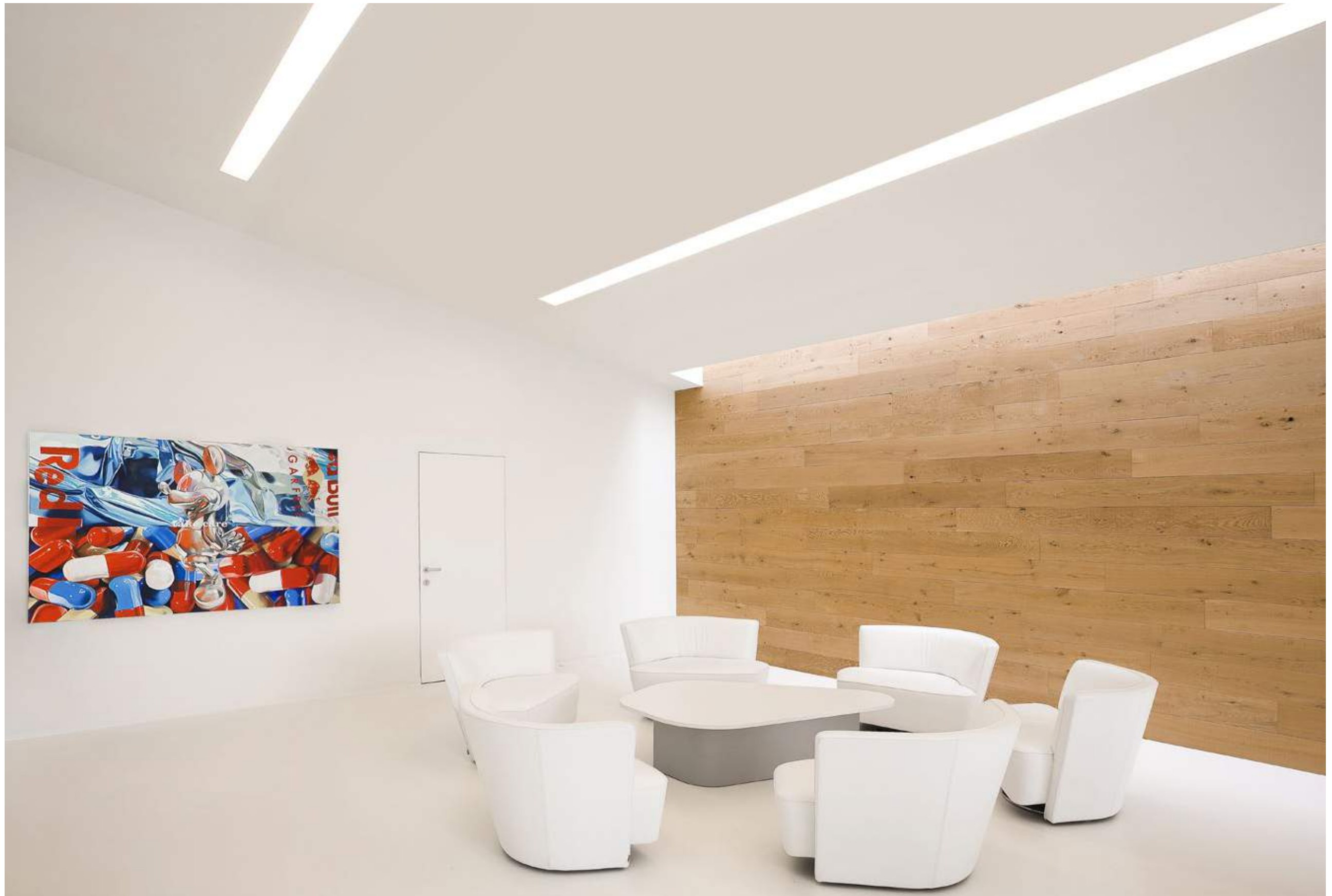

AMINOLABS HEADQUARTERS - BELGIUM

TRIENALE EXHIBITION - ITALY



598

FLOS SHOWROOM - SPAIN



599

Sistema de iluminación de luz directa general. Formado por módulos de Soft Composite que permiten su instalación en techo y que alojan en su interior módulos de iluminación de fluorescencia que garantizan una iluminación uniforme y sin sombras. Inspirado en la luminaria Kap de FLOS arquitectural. El interior del Kaprofile puede ser pintado, ofreciendo distintos decorados.

KAPPROFILE

General direct light lighting system. Comprised of Soft Composite modules that permit ceiling mounting and which house fluorescent lighting modules, thus guaranteeing uniform, shadow-free lighting. Inspired by the FLOS architectural Kap luminaire. The inside of the Kaprofile can be painted, offering different décors.

LINEAR / KAPPROFILE

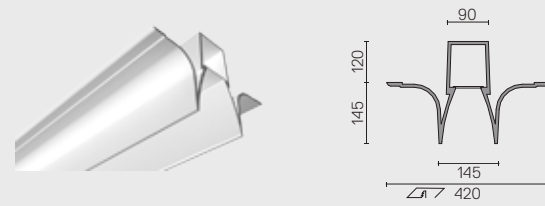

Perfil modular de tecnología Soft para una instalación a techo. Sistemas de iluminación de fluorescencia no incluidos.

Soft technology ceiling-mounted modular profile. Fluorescence lighting systems not included.

LINEAR / KAPPROFILE

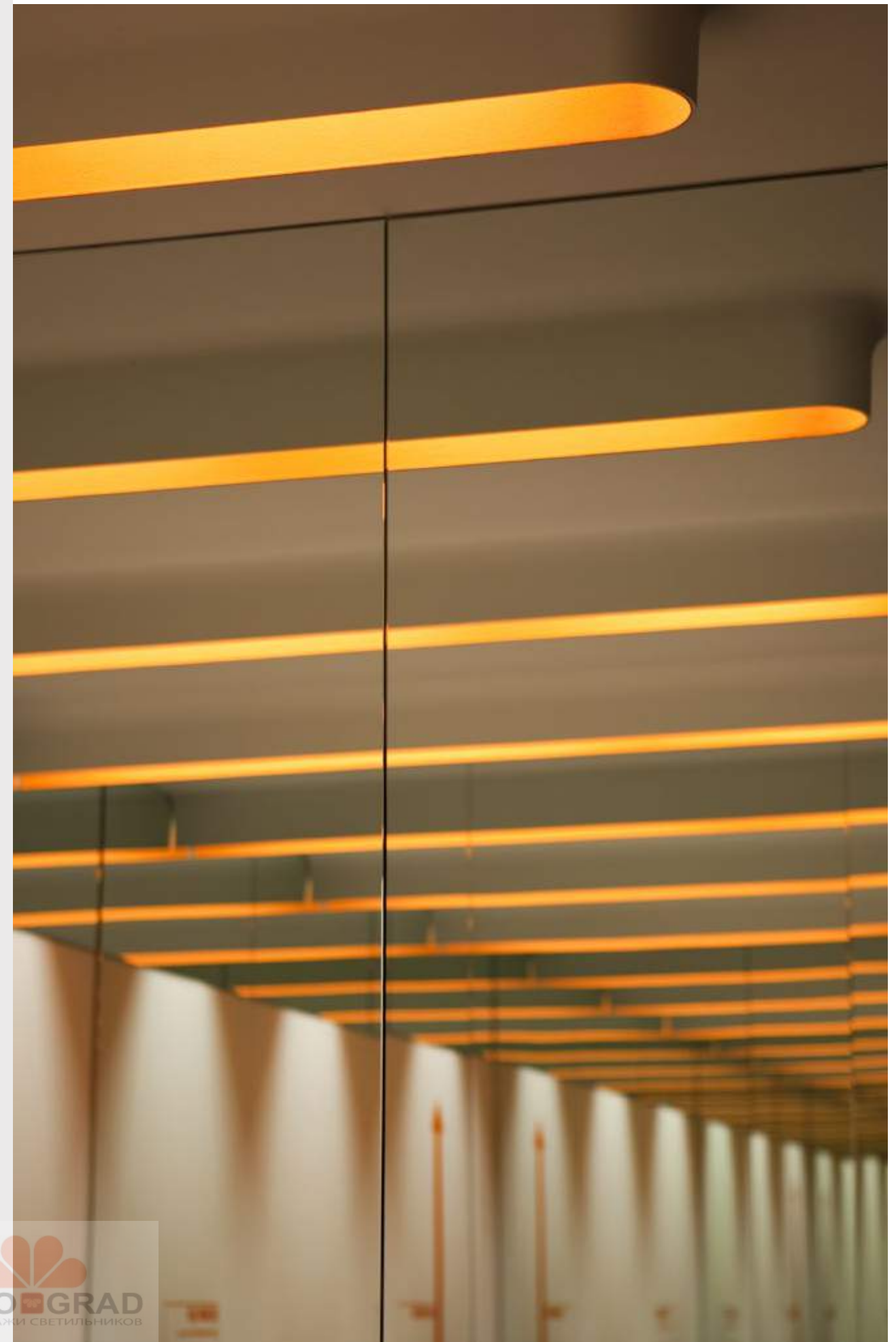



FLOS SHOWROOM - SPAIN

604

605

LightLight® In System Profile es un sistema de iluminación especialmente diseñado para alojar todos los productos de LightLight® de FLOS arquitectural. Gracias a la tecnología Soft Composite, este producto se integra perfectamente en el ambiente, minimizando el impacto visual. Está disponible en versión Surface, Flushed y Wall-Washer.

LIGHTLIGHT® IN SYSTEM PROFILE

LightLight® In System Profile is a lighting system that is especially designed to house all the FLOS architectural LightLight® products. Thanks to the Soft Composite technology, this product integrates perfectly into the environment, minimising visual impact. It is available in Surface, Flushed and Wall-Washer versions.

LINEAR / LIGHTLIGHT® IN SYSTEM PROFILE

LINEAR / LIGHTLIGHT® IN SYSTEM PROFILE

LIGHTLIGHT® IN SYSTEM
PROFILE SURFACE



Perfil modular de tecnología Soft para una instalación a techo, que permite una perfecta integración de los productos LightLight® de Flos architectural. Sistemas de iluminación no incluidos.

LIGHTLIGHT® IN SYSTEM
PROFILE FLUSHED



Soft technology ceiling-mounted modular profile, allowing for perfect integration of the Flos architectural LightLight® products. Lighting systems not included.

LIGHTLIGHT® IN SYSTEM PROFILE W-W

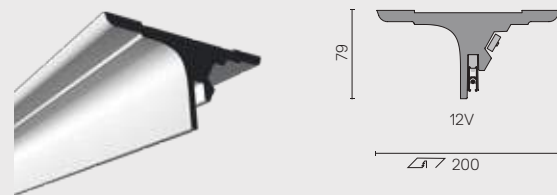

Perfil modular de tecnología Soft para una instalación a techo que permite una perfecta integración de los productos LightLight® de Flos architectural así como módulos de LEDs para iluminación indirecta. Sistemas de iluminación no incluidos.

Soft technology ceiling-mounted modular profile, allowing for perfect integration of the Flos architectural LightLight® products, as well as LED modules for indirect lighting. Lighting systems not included.



Familia de iluminación realizada en Soft Composite, disponible en formas tanto rectas como orgánicas. En combinación con productos FLOS arquitectural, la familia USP ofrece soluciones para iluminación directa, iluminación directa general y para iluminación perimetral. De esta forma se consiguen combinar las altas prestaciones que ofrecen los productos FLOS arquitectural con la tecnología Soft Composite, alcanzando un gran nivel de integración de los productos en el espacio arquitectural.

USP

Lighting family made in Soft Composite, available in straight and organic shapes. Combined with FLOS architectural products, the USP family offers solutions for direct lighting, general direct lighting and for perimeter lighting. Thus, it is possible to combine the high performance offered by the FLOS architectural products with Soft Composite technology, reaching a high product integration level into the architectural space.

LINEAR / USP

LINEAR / USP T5 DIRECT LIGHT

USP 01 18 06

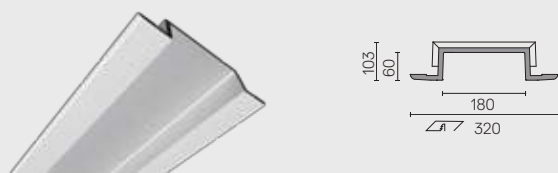

USP 01 18 15

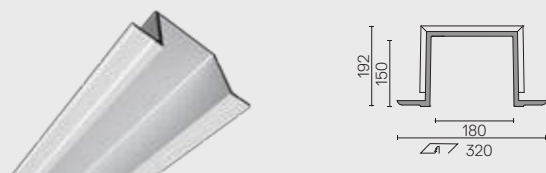

USP 02 08 12



USP 02 16 12



USP 06 18 31

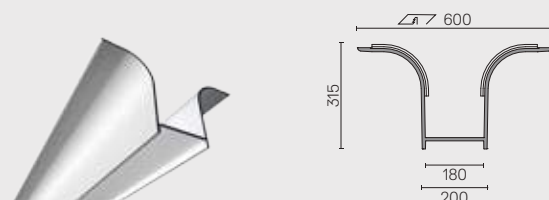

USP 12 33 21



USP 06 16 31

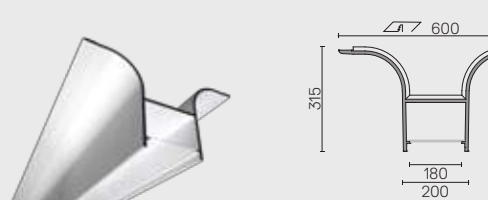

USP 11 08 12



Perfil modular de tecnología Soft para una instalación a techo que permite una perfecta integración del producto de Flos arquitectural.
Para una configuración personal, puede añadir puntos de luz en la estructura. Consultar al equipo de ventas de Flos arquitectural.

Soft technology ceiling-mounted modular profile, allowing for perfect integration of the Flos architectural product.
For personal configuration, you can add light points in the structure. Ask Flos architectural sales team.

USP 11 16 12



Perfil modular de tecnología Soft para una instalación a techo. Sistemas de iluminación de fluorescencia no incluidos.

Soft technology ceiling-mounted modular profile. Fluorescence lighting systems not included.

USP 09 18 25

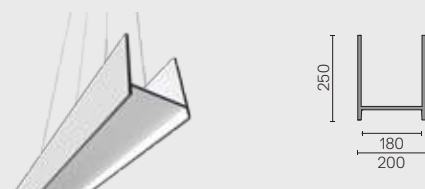

Perfil modular suspendido de tecnología Soft para una instalación a techo que permite instalar producto de Flos arquitectural.
Para una configuración personal, puede añadir puntos de luz en la estructura. Consultar al equipo de ventas de Flos arquitectural.

Soft technology suspended, ceiling-mounted modular profile, allowing for the installation of Flos architectural products.
For personal configuration, you can add light points in the structure. Ask Flos architectural sales team.

USP 09 16 25



Perfil modular de tecnología Soft suspendido para instalación a techo. Sistemas de iluminación de fluorescencia no incluidos.

Soft technology suspended, ceiling-mounted modular profile. Fluorescence lighting systems not included.



PRIVATE HOUSE - BELGIUM

LINEAR / USP INDIRECT LIGHT

LINEAR / USP INDIRECT LIGHT

USP 13 15 25

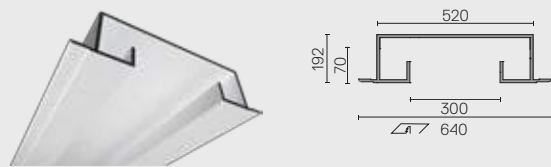

Perfil modular de tecnología Soft para instalación a techo que permite instalar producto de Flos arquitectural y sistemas de iluminación indirecta de LED o fluorescencia. Sistemas de iluminación no incluidos. Para una configuración personal, puede añadir puntos de luz en la estructura. Consultar al equipo de ventas de Flos arquitectural.

USP 14 15 25



Soft technology ceiling-mounted modular profile, allowing for the installation of Flos architectural products and indirect LED or fluorescence lighting systems. Lighting systems not included. For personal configuration, you can add light points in the structure. Ask Flos architectural sales team.

USP 03 15 25



USP 07 15 25



USP 08 15 25



Perfil modular de tecnología Soft que permite instalar sistemas de iluminación indirecta de LED o fluorescencia, no incluidos.

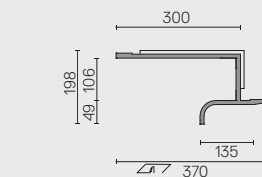

Soft technology ceiling-mounted modular profile, allowing for the installation of indirect LED or fluorescence lighting systems, not included.

USP 10 05 05

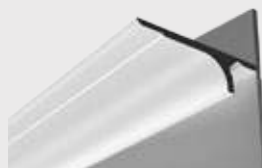

Perfil modular de tecnología Soft que permite instalar sistemas de iluminación indirecta de LED no incluidos.

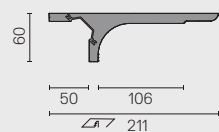

Soft technology ceiling-mounted modular profile, allowing for the installation of indirect LED lighting systems, not included.



Usl Out es una luminaria realizada con la tecnología Soft Composite con forma cónica. Al estar diseñada para instalar diversas tipologías de proyectores de FLOS arquitectural, Usl Out ofrece soluciones tanto para iluminación ambiental como de acento.

USL OUT

Usl Out is a luminaire made with Soft Composite technology and tapered shape. As it is designed to install different types of FLOS architectural spotlights, Usl Out offers solutions for both ambient and accent lighting.



OUT / USL OUT

OUT / USL OUT

USL 6031

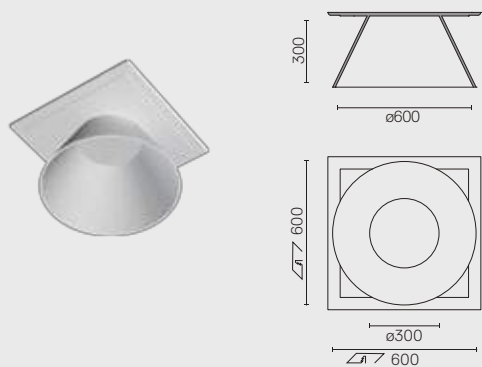

USL 6031 RECESSED

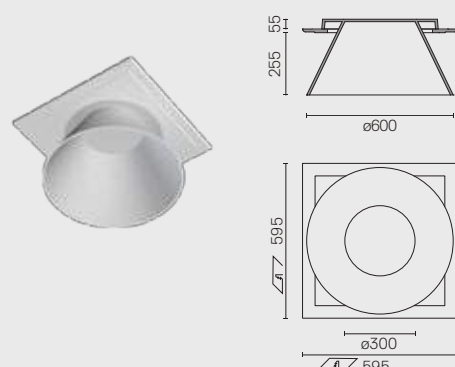

Aplicación arquitectónica de tecnología Soft que permite una perfecta integración de los productos Flos architectural.
Para una configuración personal, puede añadir puntos de luz en la estructura. Consultar al equipo de ventas de Flos architectural.

Soft technology architectonic application that permits perfect integration of the Flos architectural products.
For personal configuration, you can add light points in the structure. Ask Flos architectural sales team.

USL 6060 FOR MODULAR CEILING

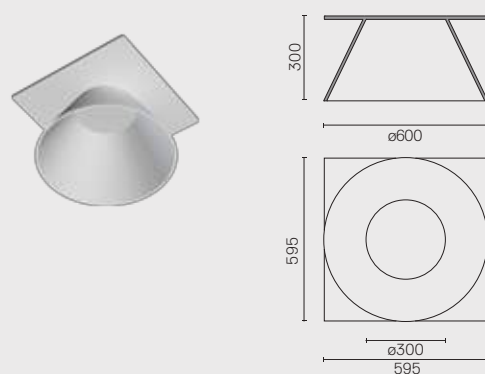

Aplicación arquitectónica de tecnología Soft para techos modulares que permite una perfecta integración de los productos Flos architectural.
Para una configuración personal, puede añadir puntos de luz en la estructura. Consultar al equipo de ventas de Flos architectural.

Soft technology architectonic application for modular ceilings that permits perfect integration of the Flos architectural products.
For personal configuration, you can add light points in the structure. Ask Flos architectural sales team.



Con el Us1 900 Disk, FLOS ofrece una solución para la iluminación ambiental utilizando la tecnología Soft Composite. Existente con fuente de luz de fluorescencia, de cátodo frío, de LED Blanco y de LED RGB.

USL 900 DISK

With the Us1 900 Disk, FLOS offers a solution for ambient lighting, using Soft Composite technology. Existent with fluorescent, cold cathode, white LED and RGB LED light source.

USL 900 DISK ON

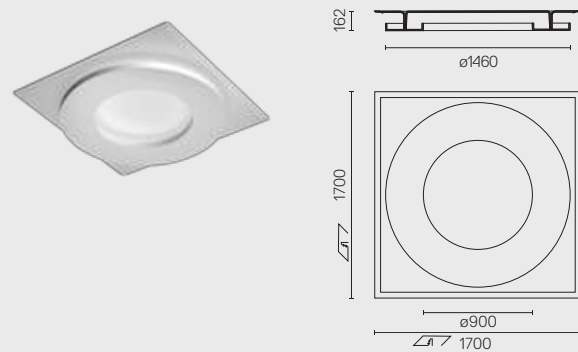

Luminaria semi-empotrada para ser instalada a techo o pared. Iluminación directa con lámparas de fluorescencia, cátodo frío o LED. Equipos no incluidos en las versiones LED.

Soft technology semi-recessed luminaire for ceiling or wall mounting. Direct lighting with fluorescent, cold cathode or LED lamps. Control gear not included in LED versions.





DISTRIBUTION

BELGIUM AND LUXEMBOURG

Flos Belux
M +32 474 413 485
Fax +39 0302438.250
flosbelux@flos.com

FRANCE

Flos S.A.R.L.
15/17 Avenue de Ségur
75007 Paris
Tel +33 (0) 1 53 59 58 88
Fax +33 (0) 1 53 59 58 89
flos@flos.fr

GERMANY

Flos GmbH
Hausinger Str. 4
40764 Langenfeld
Tel +49 2173 109 37-0
Fax +49 2173 109 37-70
info@flos-gmbh.de

UNITED KINGDOM

Atrium Ltd.
28 Leonard Street
EC2A 4BY London
Tel +44 (0)20 7681 9933
Fax +44 (0)20 7681 9943
flos@atrium.ltd.uk

DENMARK

Flos Scandinavia A/S
Sydhavnsgade 28
DK-2450 København SV
Tel +45 (0) 3388 60 00
Fax +45 (0) 3388 60 10
info@flos.dk

NORWAY

Flos Norge A/S
SjølystPlass 4
N-0278 Oslo
Tel +47 (0) 2212 86 00
Fax +47 (0) 2212 86 08
info@flos.no

THE NETHERLANDS

Flos BV
Cruquiusweg 109Q
1019 AG Amsterdam
Tel +31 (0) 20 560 50 60
Fax +31 (0) 20 560 50 70
info@flosmail.nl

U. S. A.

Flos USA Inc.
110 York Street - 5th Floor
Brooklyn, NY 11201
Tel +1 (718) 875-3472
Fax +1 (718) 875-3473
info@flosusa.com

JAPAN

Flos Co., Ltd.
PMC Building 9F
1-23-5 Higashiazabu Minato-Ku
Tokyo 104-0044
Tel +81 (0) 3 35 82 14 68
Fax +81 (0) 3 35 82 09 74
info@flosjapan.com

FAR EAST

Flos Representative Office 1,
Commonwealth Lane #08-12
149544 Singapore
Tel +65 (0) 6372 1495
Fax +65 (0) 6372 7607
flosasia@flos.com

CHINA

Flos illumination Shanghai Co Ltd
Unit 2299, 22nd floor,
68 Yin Cheng Road,
Shanghai 200120, China
Tel +86-21-61946740
Fax +86-21-61946699
floschina@flos.com

CONTACT

ITALY

Flos Spa
Via Angelo Faini, 2
25073 Bovezzo (Brescia)
Tel +39 0302438.1
Fax +39 0302438.250
info@flos.com

SPAIN

Antares Iluminación S.A.U.
Calle Mallorca, 1
Polígono Industrial Reva
46394 Ribarroja (Valencia)
Tel +34 96 166 95 20
Fax +34 96 166 82 86
flos.architectural@flos.com

SHOWROOMS

MILANO

Corso Monforte, 15
20122 Milano
Tel +39 02 79 84 57
Fax +39 02 89 78 56 41
contract.milano@flos.com

COPENAGHEN

Sydhavnsgade 28
DK-2450 København SV
Tel +45 (0) 3388 60 00
Fax +45 (0) 3388 60 10
info@flos.dk

AMSTERDAM

Cruquiusweg 109Q
1019 AG Amsterdam
The Netherlands
Tel +31 (0) 20 560 50 60
Fax +31 (0) 20 560 50 70
info@flosmail.nl

OSLO

Sjølyst Plass 4
N-0278 Oslo
Tel +47 (0) 2212 86 00
Fax +47 (0) 2212 86 08
info@flos.no

TOKYO

PMC Building 9F
1-23-5 Higashiazabu Minato-Ku
Tokyo 104-0044
Tel +81 (0) 3 35 82 14 68
Fax +81 (0) 3 55 75 70 87
info@flosjapan.com

FLAGSHIP STORES

MILANO

Corso Monforte, 9 - 20122
Tel +39 02 37011080
Fax +39 02 780833
flosmilano@flos.com

ROMA

Via del Babuino, 85 - 00187
Tel +39 06 3207631
Fax +39 06 3207690
flosroma@flos.com

PARIS

15, rue de Bourgogne - 75007
Tel +33 (0)1 53 85 49 93
Fax +33 (0)1 53 85 49 99
shop@flos.fr

LYON

17 rue Jarente - 69002
Tel +33 478621301
Fax +33 478622119
lyon@flos.fr

HONG KONG

G/F Wyndham Place, 44 Wyndham
Street, Central
Tel +852 2801 7608
Fax +852 2869 0722
dentropo@netvigator.com

STOCKHOLM

Karlaplan Lützengatan 1 - S-115-20
Tel +46 (0) 8 660 4405
Fax +46 (0) 8 660 7005
info@flos.se

NEW YORK

152 Greene Street - NY 10012
Tel +1 212 941 4760
Fax +1 212 941 4763
info@flosusa.com

CREDITS

ART DIRECTION

Omar Sosa

GRAPHIC DESIGN

Omar Sosa
Teddy Iborra Wicksteed

LAYOUT

Flos Architectural Team

ART PHOTOGRAPHY

Carl Kleiner

ILLUSTRATIONS

Aurore de La Morinerie

COMIC

Flag

TECHNICAL

Jorge Herrera Studio

IN-PLACE PHOTOGRAPHY

Fernando Alda
Germano Borrelli
Santi Caleca
Cesare Chimenti
Diana Di Nitto
David Frutos
Jesús Granada
Javier Orive
Ángel Rosique
Simona Rota
Héctor Santos
Tommaso Sartori
Shuhe
Gionata Xerra

PRINTED BY

Euroteam Brescia Italy

PHOTO PRODUCT

Piero Fasanotto
Javier Ferrer
Carlos Gutiérrez
Alessandro Lourenço

EDITION

April 2015
Copyright © Flos 2015
All rights reserved

ACKNOWLEDGEMENTS

Iñigo Beguiristain
Moba Showroom
Fran Silvestre
Negre Estudio
Pepe Cabrera
Carhartt
Val Office
Familia Parrón-Ortiz
Hakei
Moremas Arquitectos
Itínere Baqueira
RNB
Gyro Toys
Kitoko
Pitsou Kedem



OMAR SOSA BY CARL KLEINER DURING THE SHOOTING IN STOCKHOLM

As our world is in constant evolution, technical upgrades happens every day in our business.

Flos aim is to offer always the best reliable technology available, constantly reviewing our products and upgrading them as soon as technologic evolutions offers benefits for our partners and clients.

This philosophy means that our technical catalogue and product data sheets also are in constant evolution, requiring upgrades and constants reviewing.

Thus, when you need technical details and the most recent product information, please browse the product section of our Flos.com official website: it is updated daily, and there you'll find the latest product details, all available part numbers, all product documents available for immediate download.

www.flos.com

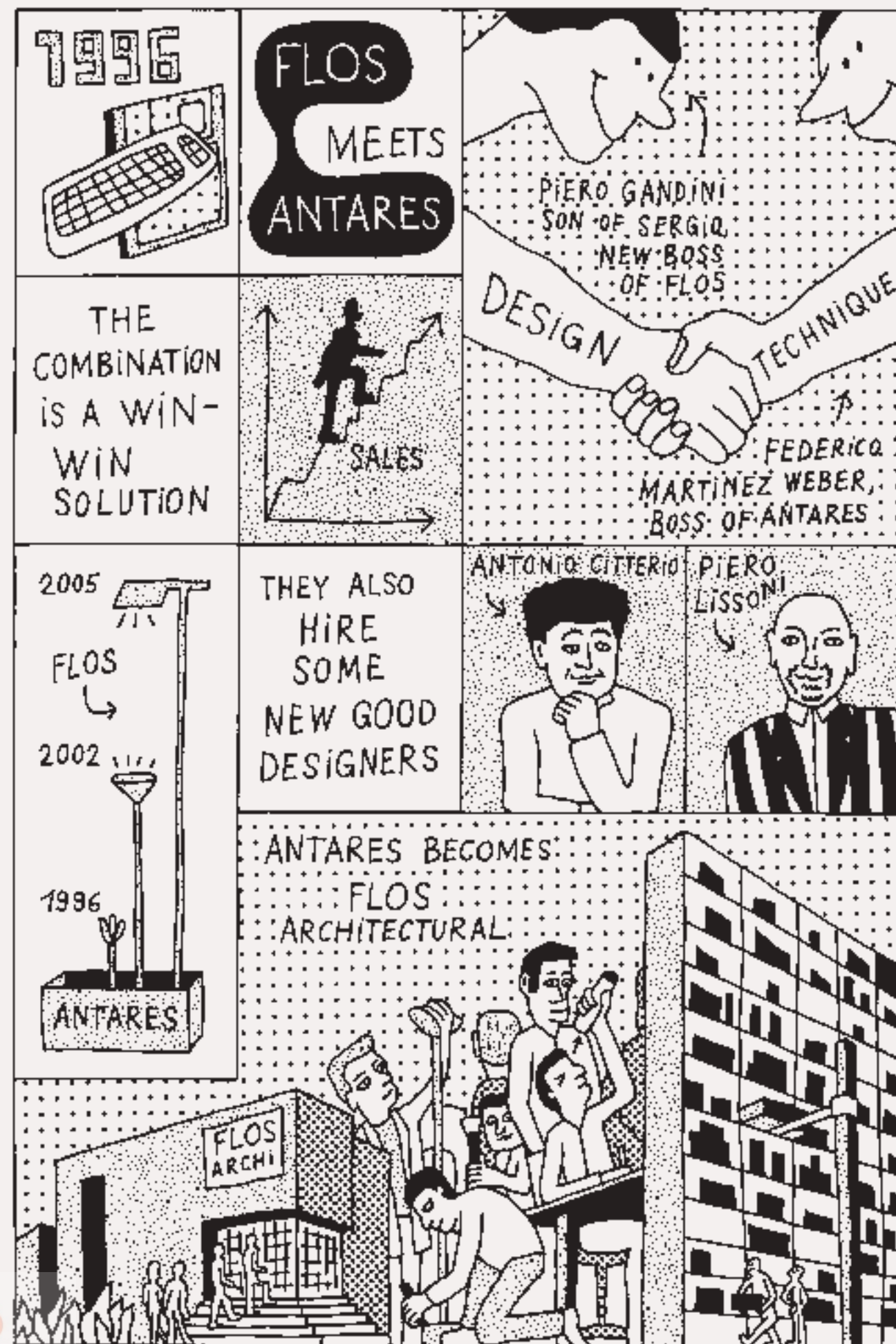

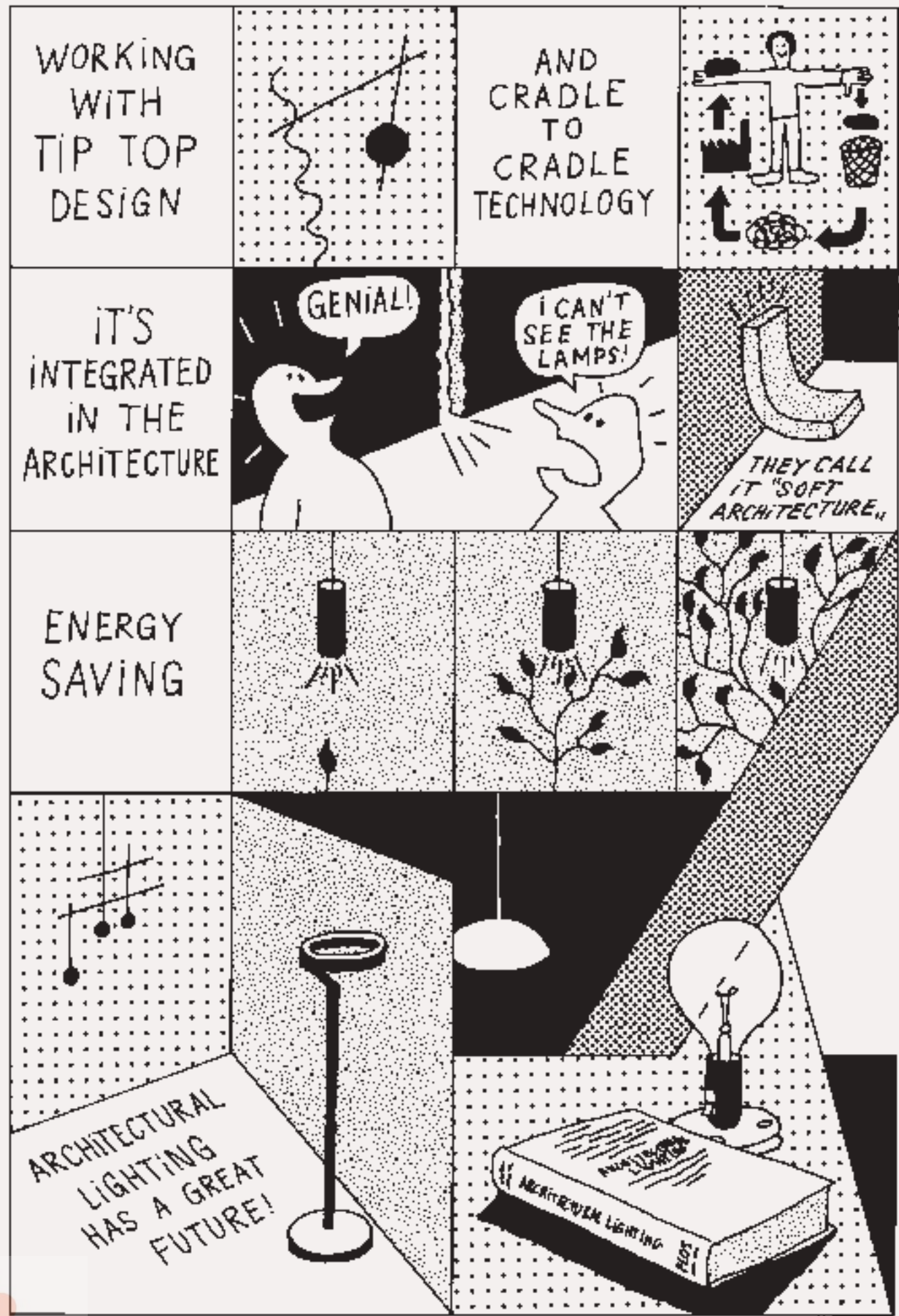
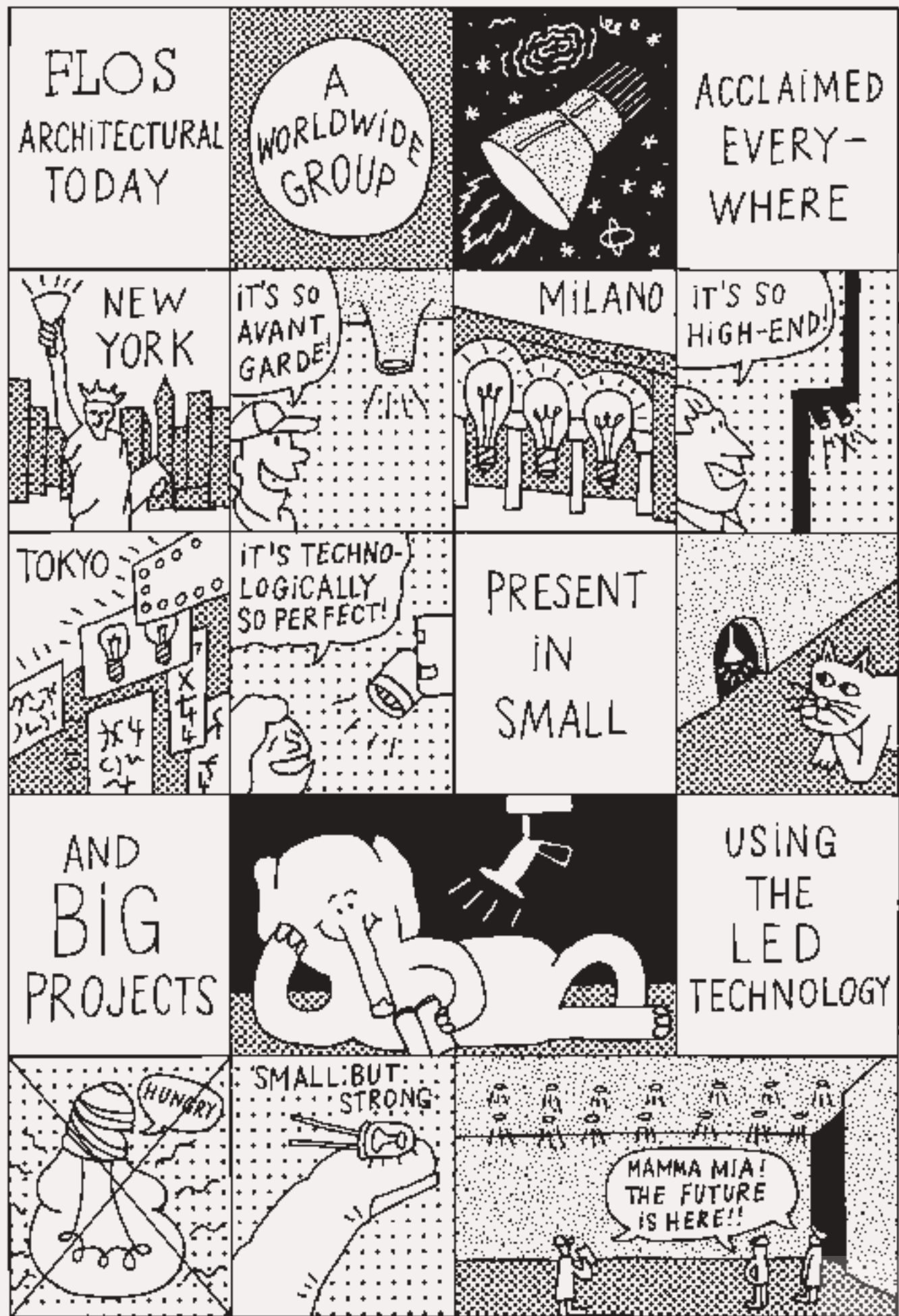

WWW.FLOS.COM