

PANZERI® DESIGN

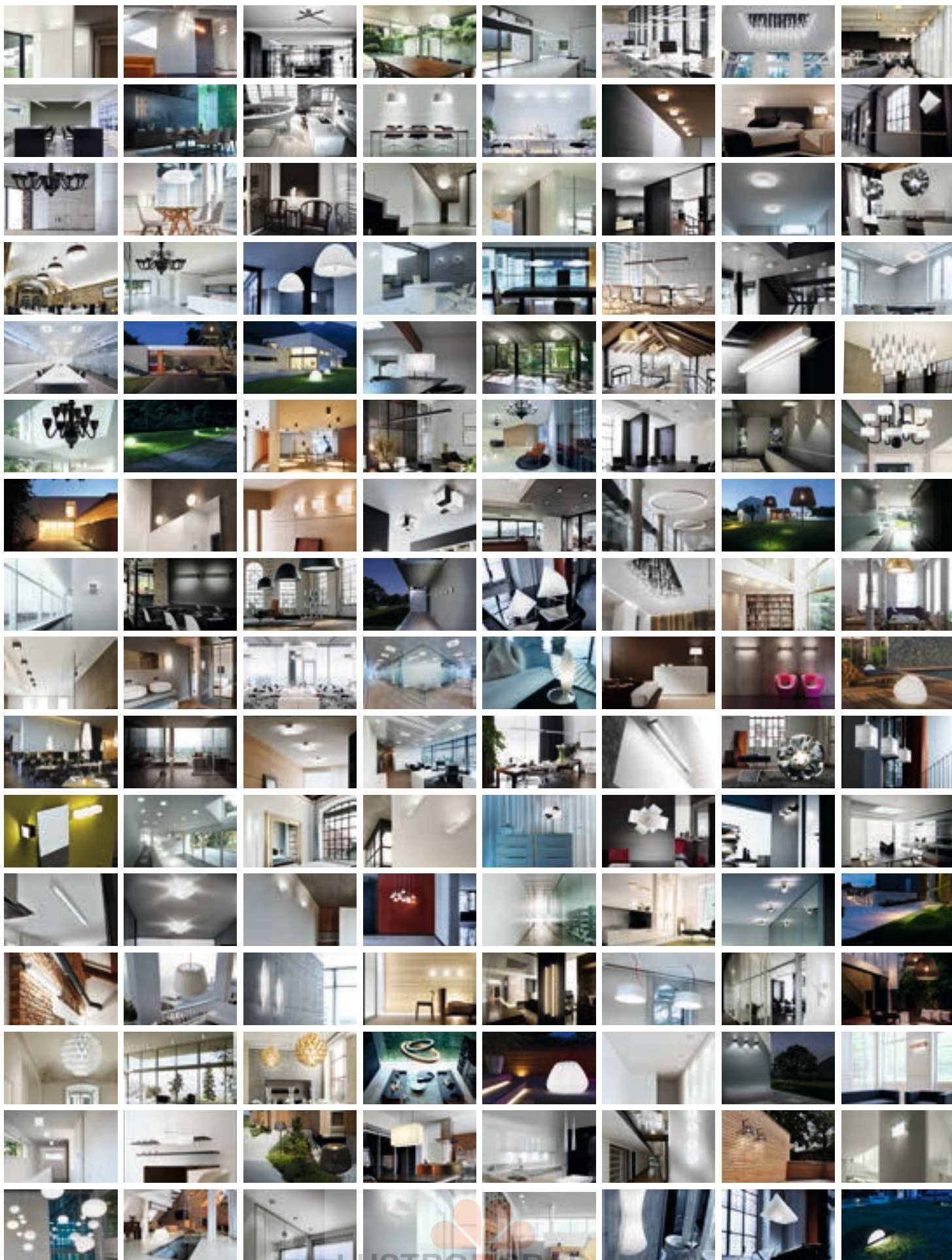

PANZERI® DESIGN

Qualità, tradizione, innovazione.

Sono questi i valori su cui si basa Panzeri, azienda che dal 1947 produce illuminazione e commercializza il Made in Italy in oltre 50 paesi nel mondo. La filosofia aziendale si sintetizza nella teoria di guardare sempre al futuro ma con un occhio attento al passato, grazie al patrimonio tradizionale e artigianale ereditato in oltre 65 anni di storia.

Lampade realizzate con cura e con attenzione ai dettagli, progettate per illuminare e per impreziosire spazi interni ed esterni con molteplici soluzioni in termini di stile, e prodotte in Italia in uno stabilimento produttivo eco-compatibile quasi interamente alimentato ad energia solare.

Quality, tradition, innovation.

These are the values that form the foundations of Panzeri, a company that has produced and sold lighting Made in Italy to over 50 countries worldwide since 1947.

The company's philosophy is summed up in the practise of constantly looking to the future while maintaining and respecting the past, its heritage of traditional craftsmanship with a history of over 65 years.

Panzeri lamps are made with care and attention to detail, designed to illuminate and decorate indoor and outdoor spaces offering multiple stylistic solutions, produced in Italy at an eco-compatible production plant almost entirely powered by solar energy.



Le lampade Panzeri sono la scelta ideale di professionisti e creativi che intendono inserire un'illuminazione dal design funzionale e personalizzabile in ambienti pubblici e privati.

Una scelta senza dubbio dettata dall'altissima qualità di ogni prodotto. La selezione delle materie prime, la sapiente tradizione e manualità per le lavorazioni più esclusive, le attrezzature e i macchinari di produzione all'avanguardia, le soluzioni innovative in ambito di tecnologie LED e un design tutto italiano, sono la chiave del successo di questa azienda che ha creduto sin dall'inizio - per mano del suo fondatore Carlo Panzeri - di poter diventare un punto di riferimento nel settore dell'illuminazione.

Panzeri lamps are the ideal choice for professionals looking for creative, functional and customizable lighting designs adapted for public and private environments.

A choice dictated by the undoubtedly high quality of all our products. Careful raw material selection, our long tradition of highly-skilled craftsmanship, the adoption of state of the art technology, innovative LED technology solutions and uniquely Italian design: these are the keys to the success of this company. These are the values we have believed in from the beginning - the ideas of its founder Carlo Panzeri - which has made our company a reference point in the lighting industry.

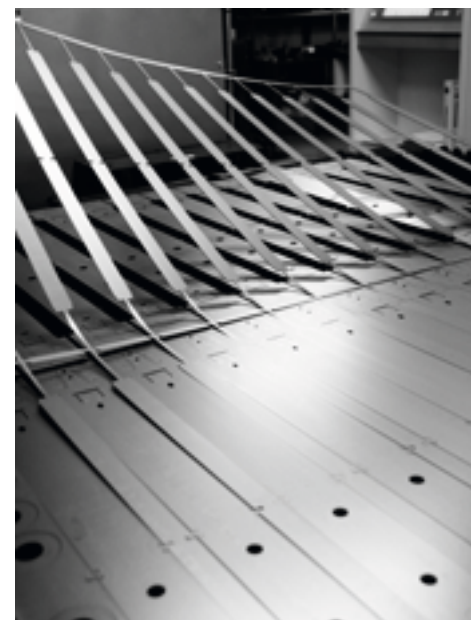
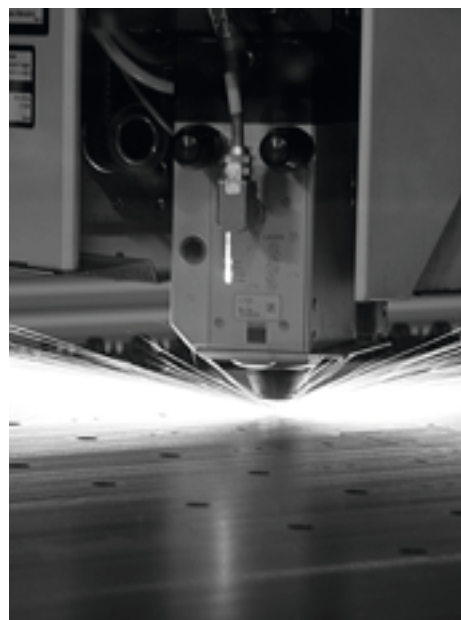

Contract&custom made_



Hertz - Paris, France

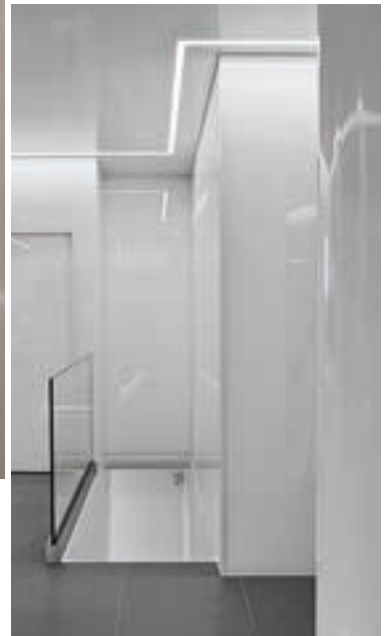

Maxi Sport - Sesto S. G., Mi, Italia





Centro Culturale IMG Candiani - Mestre, Ve - Italia

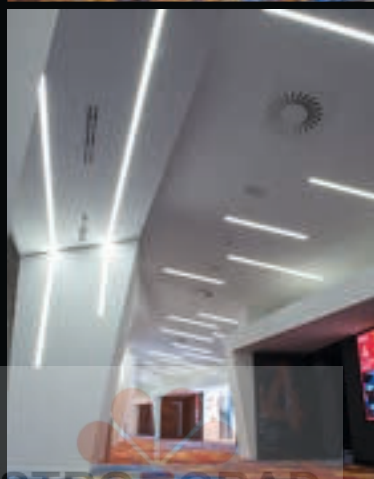



Credito Valtellinese - Milano, Italia

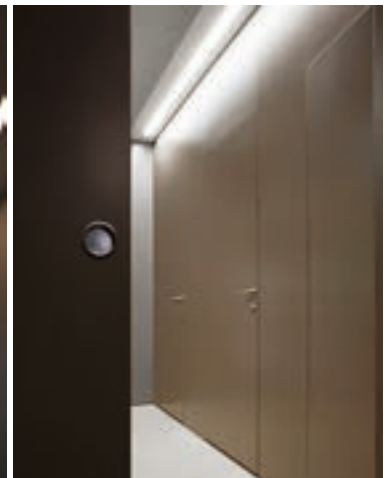
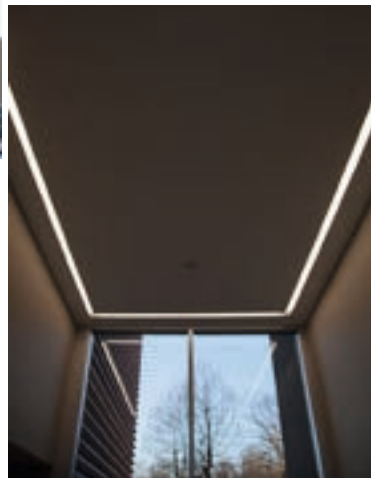
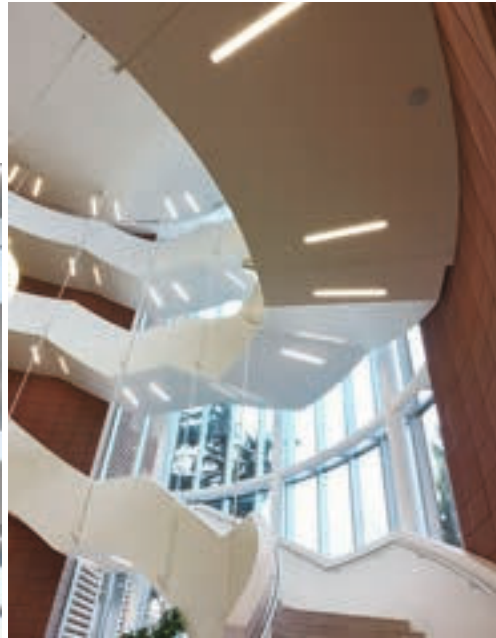
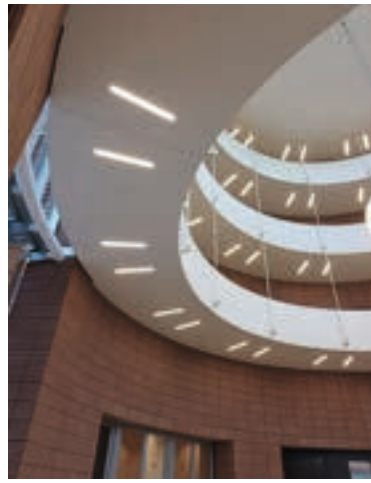



Teatro Astra - San Donà di Piave, VE, Italia
Arch. Gonçalo Byrne



Katholische Kirche - Langnau, Switzerland





Confindustria - Monza, Italia



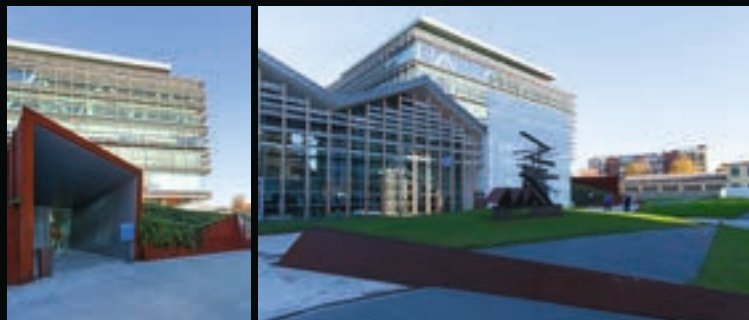

Uffici Direzionali - Milano, Italia

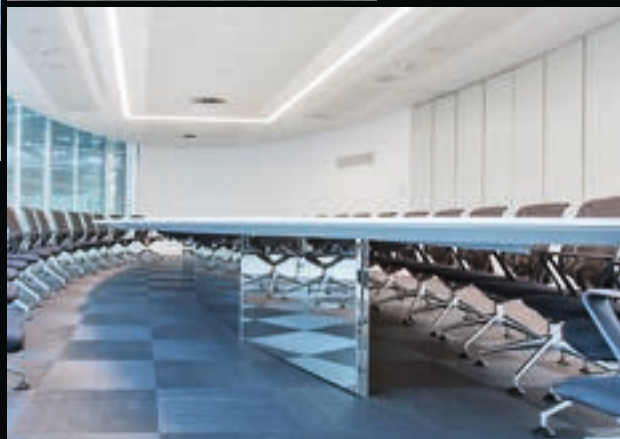



Hard Rock Hotel - Ibiza, Spain

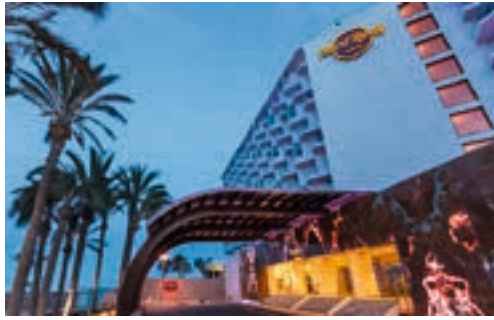

Enoteca Caffè Vistarini - Lodi, Italia





Noa Restoran - Tallin, Estonia



Hotel Bellevue - Mali Losinj, Croatia Arch. Dean Skira

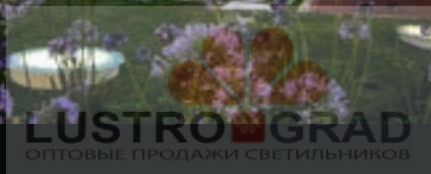

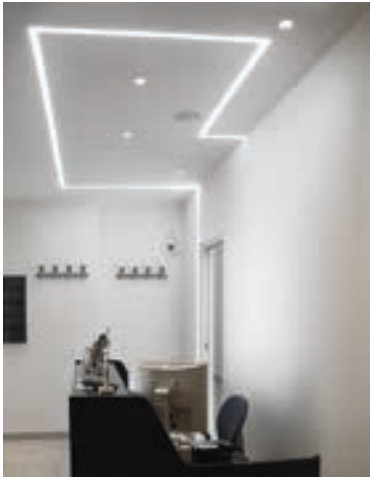

Studio dentistico - L'Aquila, Italia

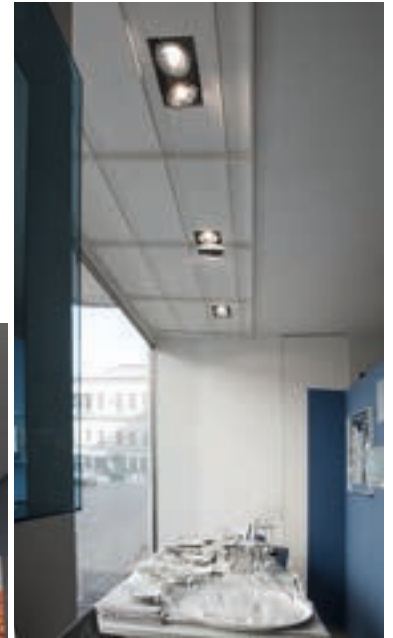

Uffici TP - Ragusa, Italia



Arredamenti Bolzoni - Rovigo, Italia

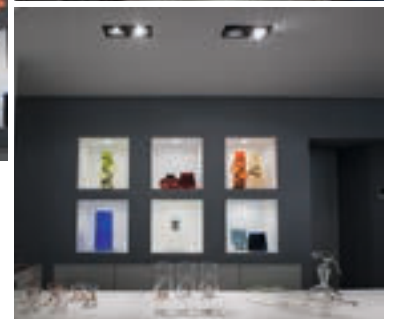



Private house, Toscana, Italia

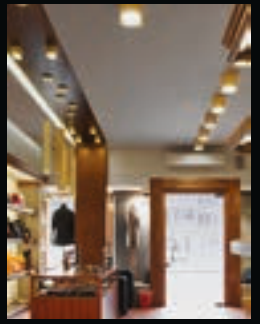

Misuri store - Firenze, Italia

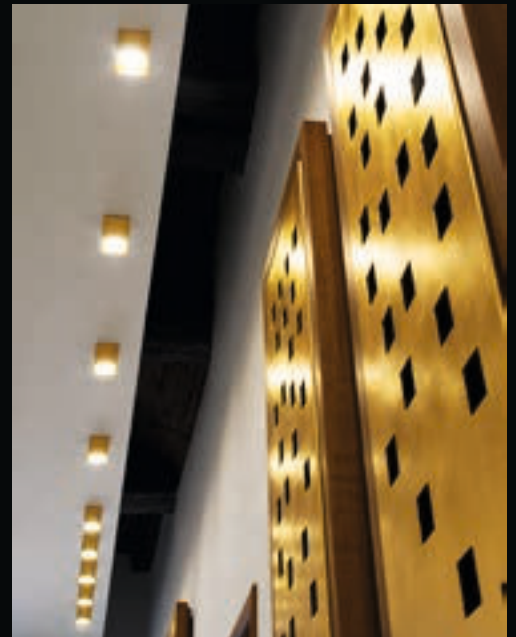

Design_

From page 23 to 399



Acheos
P 140



Blow mini
P 272



Delphina
P 380

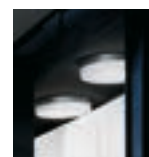

Flan
P 390



Agave
P 240



Bollard
P 394



Disco
P 260



Flat
P 178

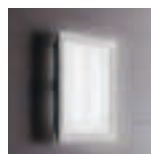

All
P 386

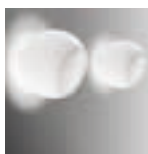

Bonbon
P 376

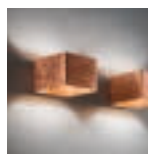

Domino
P 144

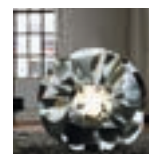

Floral
P 362



Alvi
P 312



Candle
P 308



Domino Inox
P 154



Four
P 134

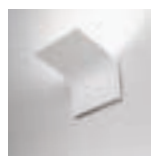

App
P 208

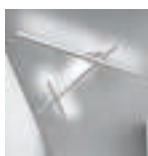

**Carmen
Carmencita**
P 198



Draco
P 280



Gilbert
P 172

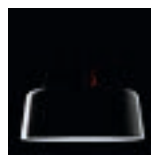

Blanca
P 188



Carrè
P 336



Dreamy
P 352



Glim
P 382

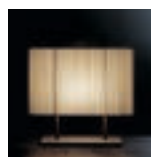

Blissy
P 340



Classic
P 330



Elle
P 276



Golden Ring
P 56



Blow
P 266



Cross
P 302



Emma&Clio
P 42



Jackie
P 24

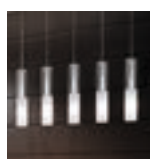

Jazz
P 262



Ralph
P 214

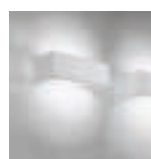

Toy gypso
P 82



Willy 60
P 92



Kubik
P 84



Rimmel
P 372



Track
P 358



Willy 100
P 104

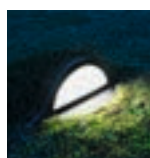

LAMPyris
P 228



Spyra
P 368



Tutu
P 246

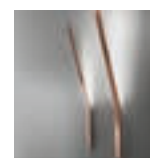

Ypsilon
P 166



Line
P 284

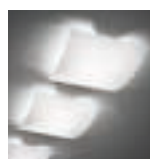

Tecla
P 296



Twister
P 254

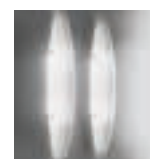

Zenith
P 318



Lucilla
P 326



Three
P 130



Two
P 124



Zero
P 158



Night
P 344



Tip_Tap
P 290



Ventitrentacinque
P 114



Decentramento
P 398

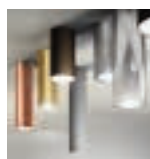

One
P 118



Tourbillon
P 322



Ventitrentatre
P 108



M89
P 399



Potter
P 234



Toy
P 72



Viky
P 348



M120
P 399

Veneziani_

From page 400 to 431

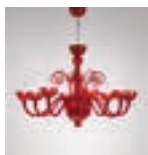

Brera
P 410



Puškin
P 418



D'Orsay
P 420



Tate
P 404



Guggenheim
P 424



Uffizi
P 408



Hermitage
P 416



Louvre
P 422



Metropolitan
P 426



Moma
P 412



Prado
P 414

Dimensioni espresse nella tabella tecnica_
Dimensions given in the specifications table_

Sospensione / Suspension

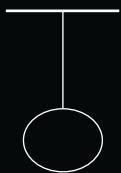

Tavolo / Table
Terra / Floor



Plafone / Ceiling
Parete / Wall



Parete / Wall

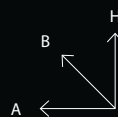
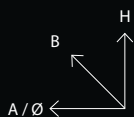
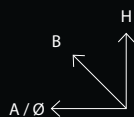
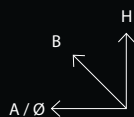
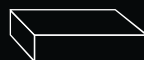

Design_

Jackie_

Design Enzo Panzeri 2015



Lampada da tavolo LED orientabile in pressofusione di alluminio. Dimmerazione con tecnologia touch. Disponibili anche versioni orientabili LED da terra, da parete, con perno passante o con morsetto. Inoltre disponibile Faretto LED orientabile parete/soffitto in versione dimmerabile o non dimmerabile.

Adjustable LED table lamp in cast aluminum alloy. Dimming with touch technology. Also available: adjustable LED floor, wall with pin or clamp versions. Also available: adjustable LED wall / ceiling spotlight, dimmable or non-dimmable.

Schwenkbare LED-Tischleuchte aus Aluguss. Dimmer mit Touch-Technologie. Auch als schwenkbare LED-Stehleuchte, Wandleuchte, befestigungsweise mittels Stift oder Lüsterklemme lieferbar. Schwenkbares LED-Spotlicht für die Wand/Decke in dimmbarer oder nicht dimmbarer Ausführung lieferbar.

Lámpara de mesa LED orientable de aluminio fundido a presión. Disponible también en versiones orientables LED de suelo, de pared, con eje pasante o con abrazadera. Además, puede ser incluido un Foco LED orientable de pared/techo en versión regulable o menos.

Lampe de table LED réglable coulée d'aluminium. Variation avec la technologie touch. Disponibles aussi en versions réglables LED sol, au mur, ou par-boulon, ou avec borne. Également disponible spot LED pivotant mur / plafond en version dimmable ou non dimmable.

Регулируемая светодиодная настольная лампа из алюминиевого сплава. Оснащена сенсорным диммером. Также доступны: регулируемые светодиодные напольные, настенные версии или версия на зажиме. Также доступен регулируемый светодиодный настенно-потолочный прожектор, диммируемый или не диммируемый.



Jackie_





Jackie_







Jackie_



Jackie_







Jackie_



Jackie_





Jackie_





Jackie_



Jackie_

design_Enzo Panzeri 2015

Registered Design

LED CE IP20 (⊕ - A/P77_ _)

Energy Label available at www.panzeri.it

220 / 240 V

	CODICE / CODE	CM A x B	H	INCHES A x B	H	LED
Tavolo / Table	C77_ _	59 x 17,5	54	23 ¼" x 6 ⅞"	21 ⅝"	8W 3000K Ra 90 600lm (STEP DIM)
Tavolo morsetto / Table clamp	C77_ _ M	59 x 10,5	53	23 ¼" x 4 ½"	20 ⅞"	8W 3000K Ra 90 600lm (STEP DIM)
Tavolo perno / Table pin	C77_ _ P	59 x 10,5	53	23 ¼" x 4 ½"	20 ⅞"	8W 3000K Ra 90 600lm (STEP DIM)
Braccio parete / Wall bracket	C77_ _ A	59 x 10,5	54	23 ¼" x 4 ½"	21 ⅝"	8W 3000K Ra 90 600lm (STEP DIM)
Terra / Floor	T77_ _	59 x 23	128	23 ¼" x 9"	50 ⅜"	8W 3000K Ra 90 600lm (STEP DIM)
Faretto parete / Wall spot	A77_ _	20 x 10,5	8,5	7 ⅞" x 4 ½"	3 ⅓"	8W 3000K Ra 90 600lm (STEP DIM)
Faretto parete-soffitto / Wall ceiling spot	P77_ _	20 x 10,5	8,5	7 ⅞" x 4 ½"	3 ⅓"	6,5W 3000K Ra 80 800lm

Fotometrie disponibili www.panzeri.it / Photometric data available at www.panzeri.it

CODICI COLORI DISPONIBILI / CODES AVAILABLE COLOURS

01 Bianco White **02** Nero Black **03** Rosso Red **30** Titanio Titanium



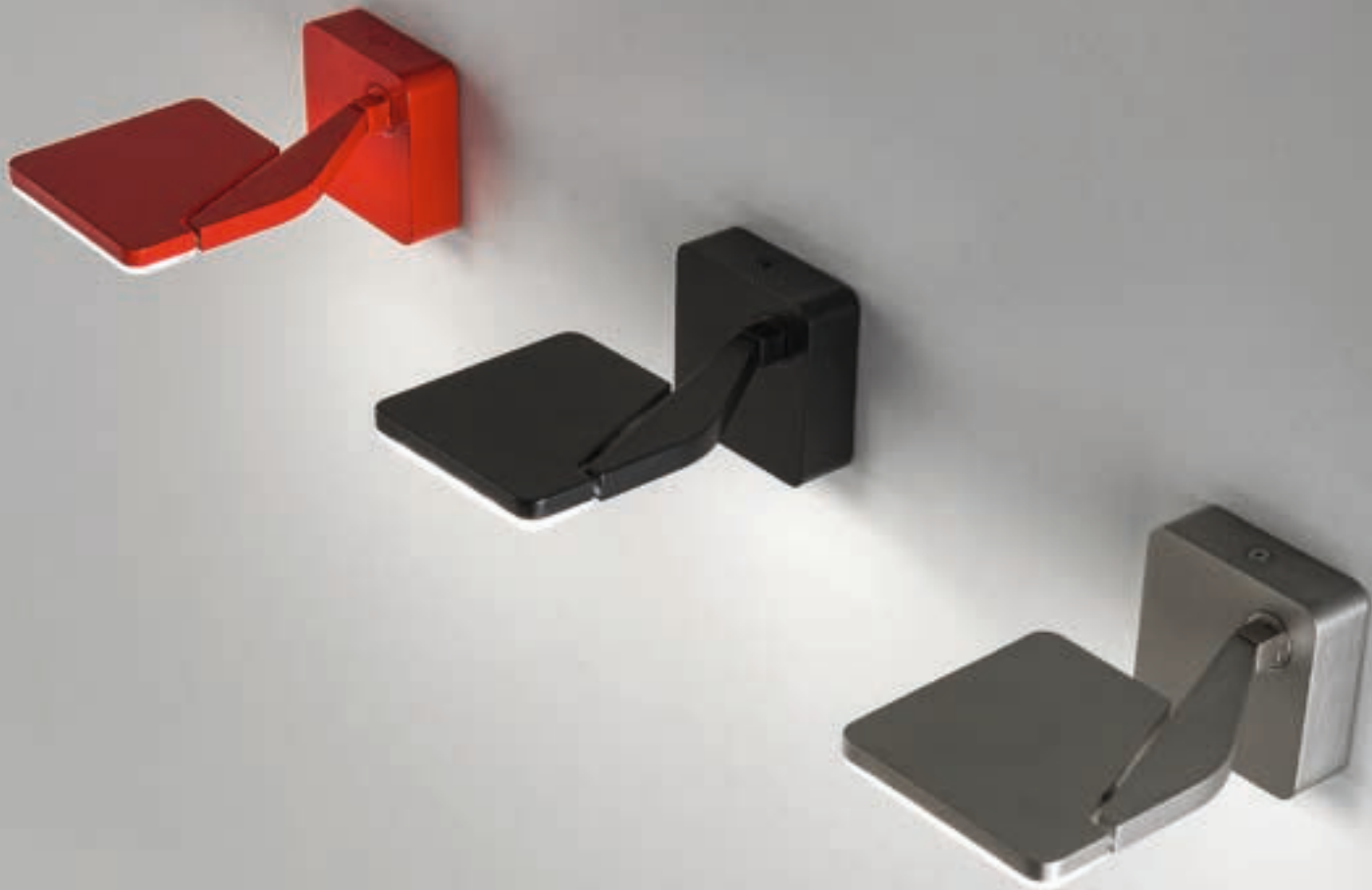

Emma&Clio_

Design Sivia Poma 2015

Lampade a sospensione con attacco E27 dotate di lampadina Led decorativa. Vetro soffiato a fermo con particolare finitura a coste, disponibile nelle versioni trasparente, acciaio, ambra, bronzo e tabacco. E' dotata di un inedito sistema di aggancio multiplo a soffitto dei corpi illuminanti che permette una grande componibilità.

Suspension lamps with E27 socket and decorative LED bulb. Blown glass with unique ribbed finish, available in these versions: transparent, steel, amber, bronze and tobacco. Equipped with a brand new system for attaching multiple ceiling lighting fixtures that allows for great modularity.

Pendelleuchten mit E27-Sockel und dekorativen LED-Lampen. Festgeblasenes Glas mit besonderer Rippenausführung, lieferbar in den Versionen Transparent, Stahl, Bernstein, Bronze und Tabak. Ausgestattet mit einem innovativen Mehrfach-Einhängesystem für die Beleuchtungskörper, wodurch vielfache Zusammenstellungen möglich sind.

Lámparas en suspensión con casquillo E27, bombillas LED decorativas incluidas. Vidrio soplado en molde con particular acabado a rayas, disponible en versión transparente, acero, ámbar, bronce y tabacco. Completas de un inedito sistema de enganche múltiple de techo, lo que permite una gran libertad de composición.

Lampes à suspension attache E27 avec ampoule Led décorative. Verre soufflé à « fermo » côtelé, disponible aussi en transparent, acier, ambre, bronze et en tabac. Elle est équipée d'un nouveau système de fixation multiple au plafond des organes d'éclairage qui permet une grande modularité.

Подвесной светильник с цоколем E27 и декоративной светодиодной лампой. Выдувное стекло с уникальной ребристой отделкой, доступно в следующих цветах: прозрачный, сталь, янтарь, бронза и "тобаско". Светильник оснащен новой системой крепления на несколько подвесов, что позволяет его моделировать.









CLIO



EMMA







Clio_





Emma&Clio_

Dotata di un inedito sistema di aggancio multiplo a soffitto dei corpi illuminanti che permette una grande componibilità.

Equipped with a brand new system for attaching multiple ceiling lighting fixtures that allows for great modularity.

Ausgestattet mit einem innovativen Mehrfach-Einhängesystem für die Beleuchtungskörper, wodurch vielfache Zusammenstellungen möglich sind.

Completa de un inedito sistema de enganche múltiple de techo, lo que permite una gran libertad de composición.

Elle est équipée d'un nouveau système de fixation multiple au plafond des organes d'éclairage qui permet une grande modularité.

Светильник оснащен новой системой крепления на несколько подвесов, что позволяет его моделировать.

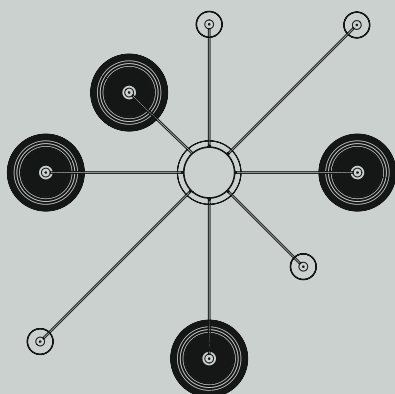
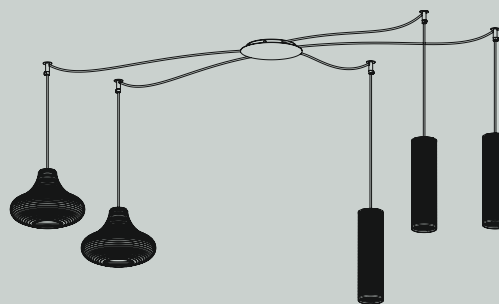
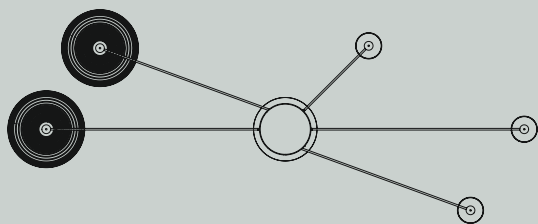
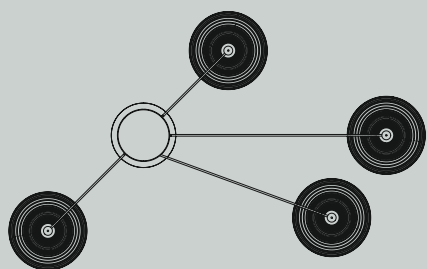

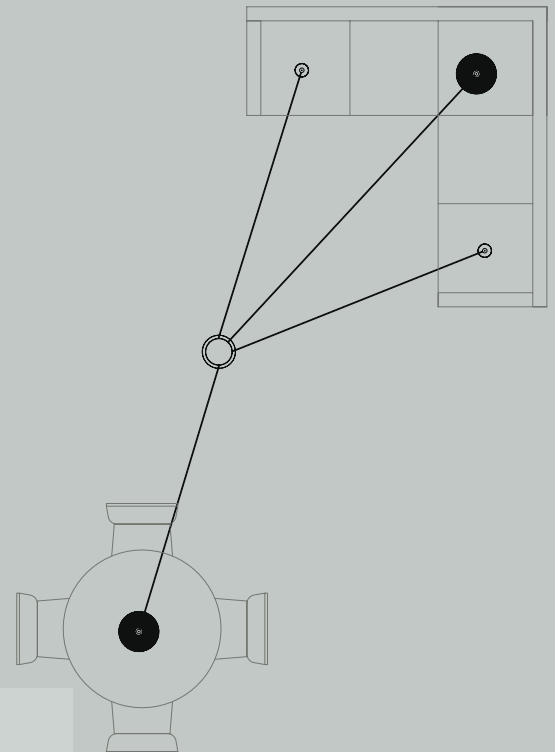
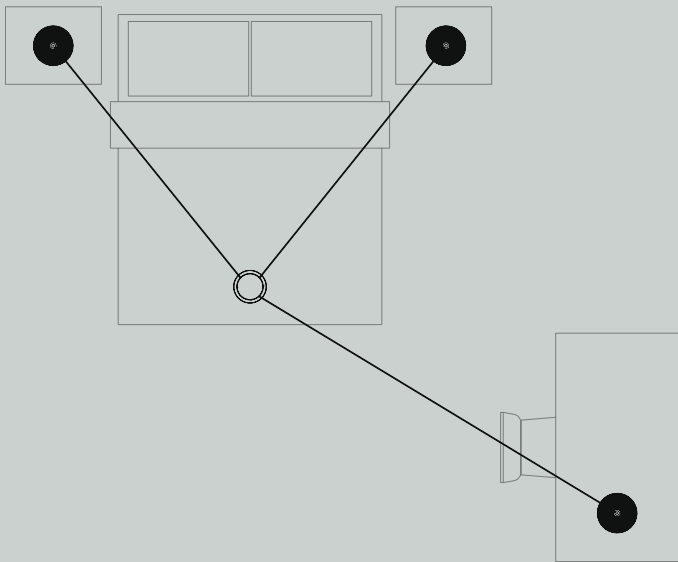
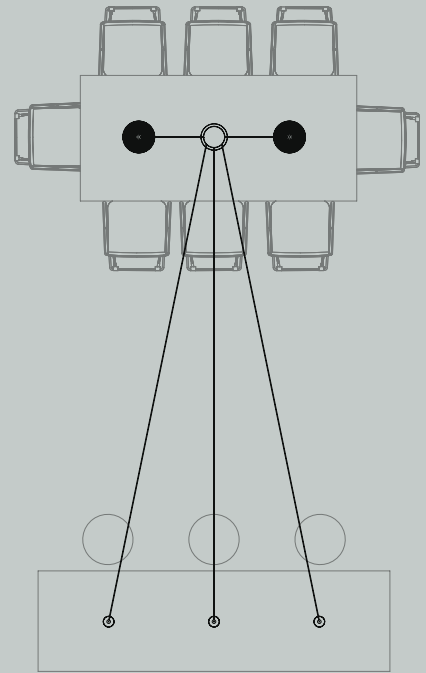
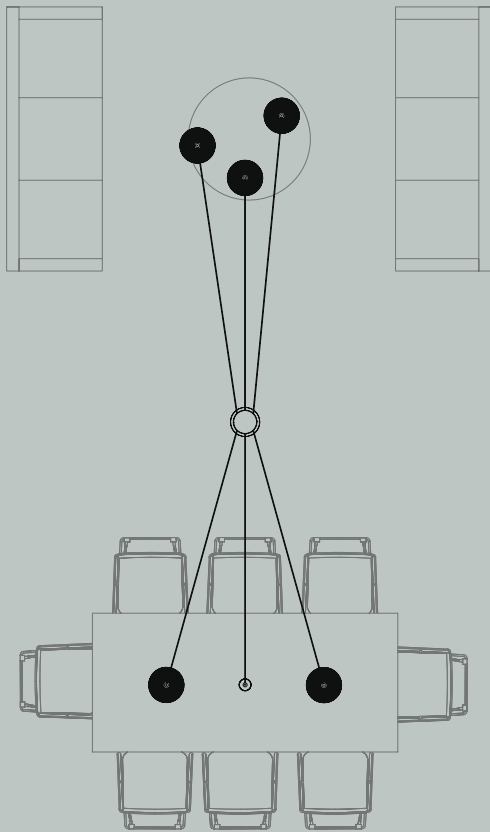

Emma&Clio_

design_Silvia Poma 2015

Registered Design



Energy Label available at www.panzeri.it

220 / 240 V

	CODICE / CODE	CM Ø	H	INCHES Ø	H	LED	HALO
Emma Sospensione / Suspension	L91_ _	26	18,5	10 ¼"	7 ¾"	Incl LED BULB 7W E27 2700K Ra 80 600lm *	max 57W E27
Sospensione senza rosone per composizioni multiple Suspension without canopy for multiple compositions	M91_ _S	26	18,5	10 ¼"	7 ¾"	Incl LED BULB 7W E27 2700K Ra 80 600lm *	max 57W E27
Rosone max 8+1 uscite Canopy max 8+1 output	M91/94_ _	21	4	8 ¾"	1 ½"		

4,50 mt cavo + appendimento in policarbonato
4,50 mt cable + polycarbonate hook

Clio Sospensione / Suspension	L94_ _	8,5	31	3 ½"	12 ½"	Incl LED BULB 7W E27 2700K Ra 80 600lm *	max 57W E27
Sospensione senza rosone per composizioni multiple Suspension without canopy for multiple compositions	M94_ _S	8,5	31	3 ½"	12 ½"	Incl LED BULB 7W E27 2700K Ra 80 600lm *	max 57W E27
Rosone max 8+1 uscite Canopy max 8+1 output	M91/94_ _	21	4	8 ¾"	1 ½"		

4,50 mt cavo + appendimento in policarbonato
4,50 mt cable + polycarbonate hook

*Not dimmable

CODICI COLORI DISPONIBILI / CODES AVAILABLE COLOURS

02 Nero
Black

25 Rame lucido
Polished copper



CODICI COLORI VETRI DISPONIBILI / CODES AVAILABLE GLASS COLOURS

-CRI Cristallo
Crystal

-STE Acciaio
Steel

-AMB Ambra
Amber

-BRO Bronzo
Bronze

-TOB Tabacco
Tobacco





Golden Ring_

Design Enzo Panzeri 2015

Serie di anelli in alluminio verniciato bianco o foglia oro, dotate di schede LED di potenza per soluzioni progettuali personalizzate in ambienti domestici o grandi composizioni per uffici, strutture ricettive e spazi pubblici. A richiesta altri colori.

Set of aluminum rings painted white or in gold leaf, equipped with power LEDs for customised design solutions for the home or large compositions for offices, hotels and public spaces.
On request other colours.

Weiß lackierte oder mit Blattgold beschichtete Aluminiumringe mit LED-Leistungskarten für individuelle Gestaltungen in Wohnungen oder groß angelegten Büroräumen, Hotelbetrieben und öffentlichen Einrichtungen. Auf Anfrage andere Farben.

Serie de anillos de aluminio barnizado blanco o pan de oro, completas de High Power LED chip para soluciones proyectivas personalizadas en ambientes domésticos o grandes composiciones para oficinas, estructuras de recepción y espacios públicos. A petición otras colores.

Série d'anneaux en aluminium peint en blanc ou feuille d'or, avec les conseils LED de puissance pour solutions de conceptions personnalisées à la maison ou grandes compositions pour les bureaux, les hôtels et les espaces publics. Sur demande autres couleurs.

Серия алюминиевых колец окрашенных в белый цвет или покрытых сусальным золотом, оснащены мощными светодиодами. Подойдут для индивидуальных дизайнерских решений для дома и больших композиций для офисов, гостиниц и общественных помещений.





Golden Ring_





Ring_
Ø 120





Golden Ring_

Ø 120





Golden Ring_

Ø 180





Golden Ring_

Ø 120

Ø 180





Golden Ring_

Ø 300



Golden Ring_

design_Enzo Panzeri 2015

Registered Design



Energy Label available at www.panzeri.it

220 / 240 V

	CODICE / CODE	CM Ø	H	INCHES Ø	H		LED
Sospensione / Suspension	L81__800 MONO	ext. 78 / int. 56,2	15	ext. 30 3/4" / int. 22 1/2"	6"	Direct light	45,5W 3000K Ra 80 5390lm
	L81__800 BIEM	ext. 78 / int. 56,2	15	ext. 30 3/4" / int. 22 1/2"	6"	Direct light / Indirect light*	91W 3000K Ra 80 5390+5390lm **
	L81__1200	ext. 123,5 / int. 101,7	15	ext. 48 2/8" / int. 40"	6"	Direct light / Indirect light*	156W 3000K Ra 80 9240+9240lm **
	L81__1800	ext. 183 / int. 161,2	15	ext. 72 1/8" / int. 63 1/2"	6"	Direct light / Indirect light*	234W 3000K Ra 80 13860+13860lm **
	L81__3000***	ext. 301 / int. 279,2	15	ext. 118 3/8" / int. 110"	6"	Direct light / Indirect light*	390W 3000K Ra 80 23100+23100lm **
	M81__-3	20		7 7/8"		Rosone opzionale per raggruppamento cavi acciaio Optional canopy to join steel cables	
	M81__-4	30		11 5/8"		Rosone opzionale per raggruppamento cavi acciaio Optional canopy to join steel cables	

* Single switching

** 800 BIEM max 4 fixtures push dim

1200 max 2 fixtures push dim

1200 max 2 fixtures push dim

1200 max 1 fixtures push dim

*** Fixture in 2 parts to compose

Fotometrie disponibili www.panzeri.it / Photometric data available at www.panzeri.it

CODICI COLORI DISPONIBILI / COLOURS CODES AVAILABLE

01 Bianco
White

21 Foglia oro
Gold leaf



Golden Ring_

Ø 300



Toy_

Design_Highlight 2007



Sospensioni, lampade da parete e soffitto in metallo bianco, marrone metallizzato, acciaio inox lucido, satinato, rame lucido (per parete cm 07, 25, 45, 60), foglia oro. A richiesta foglia argento e foglia rame. La versione da parete con diffusore in vetro. Le versioni da soffitto e sospensioni con diffusori in polycarbonato. Lampade da parete cm 25, 45, 60 e 90 disponibili anche in versione LED.

Suspensions, ceiling and wall lamps in polished, mat stainless steel, polished copper (only wall lamp cm 07, 25, 45, 60) white metal, metallized brown metal, gold leaf. On request silver and copper leaf. Glass diffuser in wall lamps and polycarbonate diffuser in suspensions and ceiling lamps. LED version also available in 25, 45, 60 and 90 cm wall lamps.

Hänge-, Wand- und Deckenleuchten in weißem Metall, braunmetallisch, Edelstahl glänzend, oder matt, Kupfer glänzend (Wand-07, 25, 45, 60 cm), Blattgold. Auf Anfrage Blattsilber und Blattkupfer. Wandversion mit Lichtverteiler aus Glas. Decken- und Hängeleuchten mit Lichtverteiler aus Polycarbonat. Wandleuchten 25, 45, 60 und 90 cm auch in LED-Ausführung.

Suspensiones, lámparas de pared, techo en metal blanco, acero inoxidable brillante, satinado, cobre lúcido (lámparas de pared cm 07, 25, 45, 60), marrón metalizado, pan de oro. A petición pan de plata y pan de cobre. La versión de pared tiene un difusor en vidrio satinado, mientras la versión de techo y suspensiones tiene un difusor en policarbonato blanco. Lámparas de pared 25, 45, 60 y 90 cm disponible también en versión LED.

Suspensions, wliques et plafonniers en métal blanc, acier inoxydable brillant, satiné, cuivre brillant (applique 07, 25, 45, 60 cm) brun métallisé, feuille d'or. Sur demande feuille d'argent et feuille cuivre. Les appliques ont le diffuseur en verre satiné, tandis que les suspensions et les plafonniers ont le diffuseur en polycarbonate. Appliques 25, 45, 60 et 90 cm disponible aussi en version LED.

Подвесные, потолочные и настенные светильники, доступны в отделках: полированная нержавеющая сталь, матовая нержавеющая сталь, медь (настенные светильники 7,25,45,60см), белый, коричневый металл, сусальное золото, сусальное серебро и сусальная медь доступны по запросу. Настенные светильники 25см, 45см, 60см и 90см доступны на LED.





Toy_





Toy_





Toy_





Toy_



Toy_		design_Highlight 2007				LED CE IP20		
Energy Label available at www.panzeri.it								
220 / 240 V								
	CODICE / CODE	CM A x B	H	INCHES A x B	H	LED	FLUO	HALO
Sospensione / Suspension	L 16_._60	74 x 7,5	9	29" x 3"	3 1/2"		80W/830 2G11	
	L 16_._120	134 x 7,5	9	52 3/4" x 3"	3 1/2"		2x54W/830 G5	
Soffitto / Ceiling	P 16_._25	32 x 7,5	9	12 1/2" x 3"	3 1/2"		26W/830 G24 q-3	
	P 16_._60	74 x 7,5	9	29" x 3"	3 1/2"		80W/830 2G11	
	P 16_._120	134 x 7,5	9	52 3/4" x 3"	3 1/2"		2x54W/830 G5	
Parete / Wall	*A 16_._07	7,5 x 8,5	7,5	3" x 3 1/4"	3"			max 48W G9
	A 16_._25	25 x 8,5	7	9 7/8" x 3 1/4"	2 3/4"		26W/830 G24 q-3	
	*A 16_._25 LED	25 x 8,5	7	9 7/8" x 3 1/4"	2 3/4"			
	A 16_._25 HALO	25 x 8,5	7	9 7/8" x 3 1/4"	2 3/4"			max 80W R7s 78 mm
	A 16_._45	45,5 x 8,5	7	18" x 3 1/4"	2 3/4"		36W/830 2G11	
	*A 16_._45 LED	45,5 x 8,5	7	18" x 3 1/4"	2 3/4"	24W 3000K Ra 80 1460lm + 1460lm		
	A 16_._45 HALO	45,5 x 8,5	7	18" x 3 1/4"	2 3/4"			2x max 80W R7s 78 mm
	A 16_._60	61 x 8,5	7	24" x 3 1/4"	2 3/4"		80W/830 2G11	
	*A 16_._60 LED	61 x 8,5	7	24" x 3 1/4"	2 3/4"	36W 3000K Ra 80 2190lm + 2190lm		
	A 16_._60 HALO	61 x 8,5	7	24" x 3 1/4"	2 3/4"			2x max 80W R7s 117 mm
	A 16_._90	88,5 x 8,5	7	34 7/8" x 3 1/4"	2 3/4"		2x39W/830 G5	
	A 16_._90 LED	88,5 x 8,5	7	34 7/8" x 3 1/4"	2 3/4"	48W 3000K Ra 80 2920lm + 2920lm		
A 16_._120	119 x 8,5	7	46 7/8" x 3 1/4"	2 3/4"		2x54W/830 G5		

Fotometrie disponibili www.panzeri.it / Photometric data available at www.panzeri.it

CODICI COLORI DISPONIBILI / COLOURS CODES AVAILABLE

01 Bianco White	21 Foglia oro Gold leaf	23 Foglia argento (a richiesta) Silver leaf (available on request)	24 Foglia rame (a richiesta) Copper leaf (available on request)	*25 Rame lucido Polished copper	37 Acciaio inox lucido Polished stainless steel	39 Acciaio inox satinato Mat stainless steel	44 Marrone metallizzato Metallized brown
---------------------------	-----------------------------------	--	---	--	---	---	---



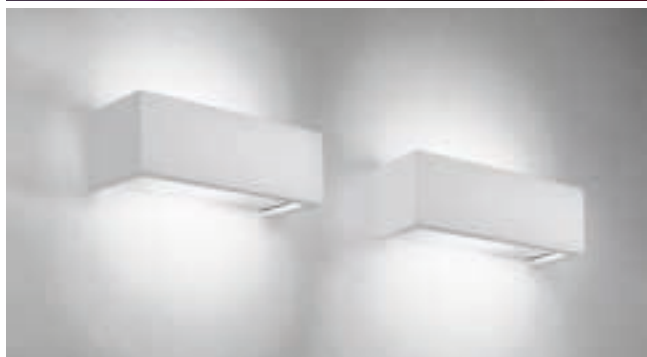

Lampada da parete in gesso.
Montatura in metallo bianco e diffusori in
vetro satinato. Disponibile anche in
versione LED.

Wall lamp in plaster. White fitting and mat
glass diffuser. LED version also available.

Wandleuchte in Gips. Weißer Struktur
und Mattglas. Hängeleuchte auch in
LED-Ausführung.

Lámpara de pared en yeso.
Montura en metal blanco y difusores en
vidrio satinado. Disponible también en
versión LED.

Applique en gypse. Monture en métal
blanc et diffuseurs en verre satiné.
Disponible aussi en version LED.

Бра из гипса. Арматура из металла белого
цвета и рассеиватели из сатинированного
стекла. Возможен вариант со
светодиодной лампой.





Toy gypso_

design_Highlight 2011

 **CE IP20**

Energy Label available at www.panzeri.it

220 / 240 V

	CODICE / CODE	CM A x B	H	INCHES A x B	H	LED	FLUO
Parete / Wall	A 1642.25	27 x 9,5	8,5	10 1/2" x 3 3/4"	3 1/4		26W/830 G24 q-3
	A 1642.25 LED	27 x 9,5	8,5	10 1/2" x 3 3/4"	3 1/4	12W 3000K Ra 80 730lm + 730lm	
	A 1642.60	61 x 8,5	8,5	24" x 3 1/4"	3 1/4		80W/830 2G11
	A 1642.60 LED	61 x 8,5	8,5	24" x 3 1/4"	3 1/4	36W 3000K Ra 80 2190lm + 2190lm	

Fotometrie disponibili www.panzeri.it / Photometric data available at www.panzeri.it

CODICI COLORI DISPONIBILI / COLOURS CODES AVAILABLE

42 Gesso
Plaster





Sospensione, plafoniera, lampada da terra, da tavolo e da parete.
Vetro soffiato bianco satinato.
Sospensione, lampada da tavolo e parete/soffitto anche in versione LED.

Suspension, ceiling, floor, table and wall lamp. Blown white mat glass.
Suspension, table, wall/ceiling lamp also in LED version.

Hänge, Decken-, Steh-, Tisch- und Wandleuchte. Mundgeblasenes Glas weiß satiniert.
Hänge-Tisch-,Decken/Wandleuchte auch in LED Ausführung.

Suspensión, plafón, lámpara de suelo, de mesa y de pared. Vidrio soplado blanco satinado.
Suspensión lámpara de mesa y de pared/techo también en versión LED.

Suspension, plafonnier, lampe au sol, lampe de table et applique.
Verre soufflé blanc satiné.
Suspension, lampe de table et applique/plafon aussi en version LED.

Подвесные, потолочные, напольные, настольные и настенные светильники.
Выдувное стекло белого матового цвета.
Подвесные, настольные и настенно-потолочные светильники доступны на LED.







Kubik_





Kubik_





Kubik_



Kubik_

design_Team Design 2001

LED CE IP40 (IP20) Table / Floor

Energy Label available at www.panzeri.it

220 / 240 V

	CODICE / CODE	CM A x B	H	INCHES A x B	H	LED	FLUO	HALO
Sospensione / Suspension	L 7033.11 LED	11 x 11	73 → 128	4 ¼" x 4 ¼"	28 ¾" → 50 ½"	8W 3000K Ra 80 1080lm		
	L 7033.11	11 x 11	73 → 128	4 ¼" x 4 ¼"	28 ¾" → 50 ½"			max 48W G9
	L 7033.14 LED	14 x 14	76 → 128	5 ½" x 5 ½"	30" → 50 ½"	12W 3000K Ra 80 1460lm		
	L 7033.14	14 x 14	76 → 128	5 ½" x 5 ½"	30" → 50 ½"			max 60W G9
Parete / Wall	A 7033.11 LED	11 x 11	11	4 ¼" x 4 ¼"	4 ¼"	8W 3000K Ra 80 1080lm		
	A 7033.11	11 x 11	11	4 ¼" x 4 ¼"	4 ¼"			max 60W E14
	A 7033.14 LED	14 x 14	14	5 ½" x 5 ½"	5 ½"	12W 3000K Ra 80 1460lm		
	A 7033.14	14 x 14	14	5 ½" x 5 ½"	5 ½"		max 23W Micro Twist E27	max 70W E27
	A 7033.25	25 x 6	11	9 ¾" x 2 ¾"	4 ¼"			max 80W R7s 117 mm
	A 7033	14 x 7	29	5 ½" x 2 ¾"	11 ½"		max 23W Micro Twist E27	max 70W E27
Tavolo / Table	C 7033.11 LED	11 x 11	11	4 ¼" x 4 ¼"	4 ¼"	8W 3000K Ra 80 1080lm		
	C 7033.14 LED	14 x 14	14	5 ½" x 5 ½"	5 ½"	12W 3000K Ra 80 1460lm		
Terra / Floor	T 7033	27	162	10 ½"	63 ¾"			max 205W E27 dimmer

Fotometrie disponibili www.panzeri.it / Photometric data available at www.panzeri.it

CODICI COLORI DISPONIBILI / COLOURS CODES AVAILABLE

33 Grigio metallizzato
Metallized grey



ps://www.lustrograd.com/vendors/panzeri/

Willy_

Design_Enzo Panzeri
2002/2007/2009



Sospensioni in vetro soffiato bianco satinato o decorato nero Ø 16 cm, Ø 40 cm, Ø 50 cm e Ø 60 cm (Ø 60 anche in versione con alogenuri metallici) con diffusore in lastra di vetro. Montature in grigio metallizzato. La versione Ø 60 è disponibile anche in alluminio grigio o grigio micaceo o in bianco lucido, anche in versione con alogenuri metallici. La versione Ø 60 è disponibile anche in alluminio foglia oro. A richiesta foglia argento o foglia rame e LED.

Suspensions in white blown or black painted glass, Ø 16 cm, Ø 40 cm, Ø 50 cm and Ø 60 cm (the Ø 60 cm model also with metal halide lamps) with glass sheet as diffuser. Fittings in metallized grey metal. The Ø 60 cm version is available in grey or micaceous grey aluminium or in glossy white also with metal halide lamps. The Ø 60 cm version is available in gold. On request silver or copper leaf. Also available in LED version.

Hängeleuchten aus weißem, mundgeblasenem Glas oder schwarz dekoriertem Glas Ø 16 cm, Ø 40 cm, Ø 50 cm und Ø 60 cm (Ausführung mit Ø 60 cm auch mit Metalldampflampen erhältlich) mit Lichtverteiler aus Glas. Die Ausführung Ø 60 cm ist auch aus Aluminium graumetallic, grau glimmerig oder glänzend weiß auch mit Metalldampflampen erhältlich. Die Version Ø 60 cm ist auch aus Aluminium mit Blattgold. Auf Anfrage Blattsilber oder BlattKupfer und LED erhältlich.

Suspensión en vidrio soplado blanco o decorado negro, Ø 16 cm, Ø 40 cm, Ø 50 cm y Ø 60 cm (Ø 60 cm en versión con bombilla de alogenuro metálico también) con difusor en lastra de vidrio. Montura en gris metalizado. La versión Ø 60 cm es disponible en aluminio gris o en gris micaceo o en blanco brillante, también en la versión con alogenuro metálico. La versión Ø 60 cm es disponible en aluminio pan de oro. A petición pan de plata o pan de cobre y LED.

Suspensions en verre soufflé blanc satiné ou décoré noir, Ø 16 cm, Ø 40 cm, Ø 50 cm et 60 cm (Ø 60 cm aussi en version aux halogénures métalliques) avec diffuseur en plaque de verre. Monture en gris métallisé. La version Ø 60 cm est disponible en aluminium gris ou gris micacé ou blanc brillant aussi en version aux halogénures métalliques. La version Ø 60 cm est disponible en aluminium feuille d'or. Sur demande feuille d'argent ou feuille de cuivre et LED.

Подвесные светильники выдувного стекла, белого либо окрашенного в черный цвета, Ø 16cm, Ø 40cm, Ø 50cm и Ø 60cm со стеклянным диффузором. Арматура выполнена в цвете серый металлик. Версия Ø 60cm доступна в цветах серый алюминий, серый слюдяной алюминий, глянцевый белый, сусальное золото. Сусальное серебро и сусальная медь доступны по запросу. Также светильник Ø 60cm доступен в версиях с металлогалогенной лампой и на LED.



Willy_



WILLY60



WILLY50



WILLY40



WILLY16



WILLY100

Willy_

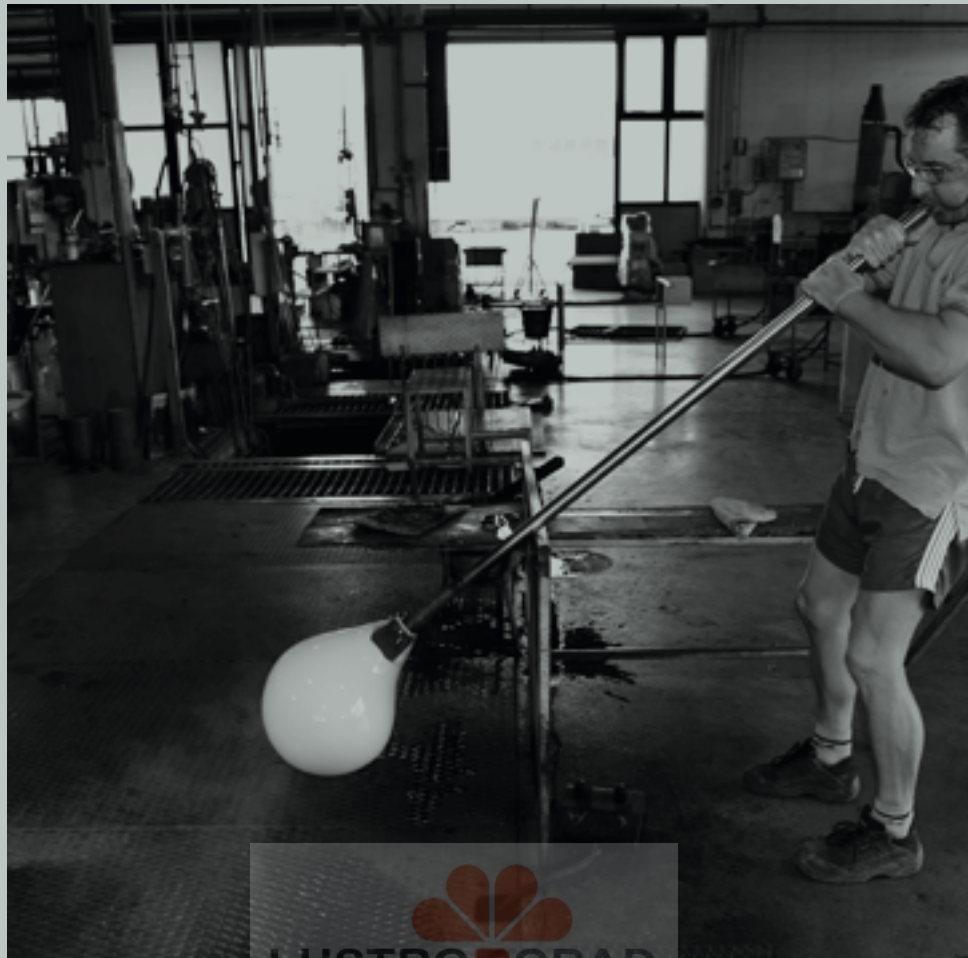



Willy_





Willy 60_

design_Enzo Panzeri 2002



Vetro / Glass

Energy Label available at www.panzeri.it

220 / 240 V

	CODICE / CODE	CM Ø H	INCHES Ø H	LED	FLUO	HALO
Sospensione / Suspension	L 7633.16	16 25	6 1/4" 9 7/8"			max 48W G9
	L 7633.16 BLACK	16 25	6 1/4" 9 7/8"			max 48W G9
	L 7633.40	40 28	15 3/4" 11"		max 23W Micro Twist E27	max 150W E27
	L 7633.40 BLACK	40 28	15 3/4" 11"		max 23W Micro Twist E27	max 150W E27
	L 7633.50	50 30	19 5/8" 11 3/4"		max 30W Superstar E27	max 150W E27
	L 7633.50 BLACK	50 30	19 5/8" 11 3/4"		max 30W Superstar E27	max 150W E27
	L 7633.60	60 37- max 237	23 5/8" 14 5/8" - max 93 3/8"		3x max 30W Superstar E27	3x max 100W E27
	L 7633.60 BLACK	60 37- max 237	23 5/8" 14 5/8" - max 93 3/8"		3x max 30W Superstar E27	3x max 100W E27
	L 7633.60 LED	60 37- max 237	23 5/8" 14 5/8" - max 93 3/8"	44W 3000K Ra 80 4170lm		
	L 7633.60 LED BLACK	60 37- max 237	23 5/8" 14 5/8" - max 93 3/8"	44W 3000K Ra 80 4170lm		
	L 7633.60 HI	60 37- max 237	23 5/8" 14 5/8" - max 93 3/8"			70W E27 HCl / HQI
	L 7633.60 HI BLACK	60 37- max 237	23 5/8" 14 5/8" - max 93 3/8"			70W E27 HCl / HQI

Fotometrie disponibili www.panzeri.it / Photometric data available at www.panzeri.it

CODICI COLORI DISPONIBILI / COLOURS CODES AVAILABLE

33 Grigio metallizzato_bianco
Metallized grey_white

33 Grigio metallizzato_nero
Metallized grey_black





34
Grigio micaceo
Micaceous grey

33
Grigio metallizzato
Metallized grey

10
Bianco lucido
Glossy white

Willy 60_

Design Enzo Panzeri 2009

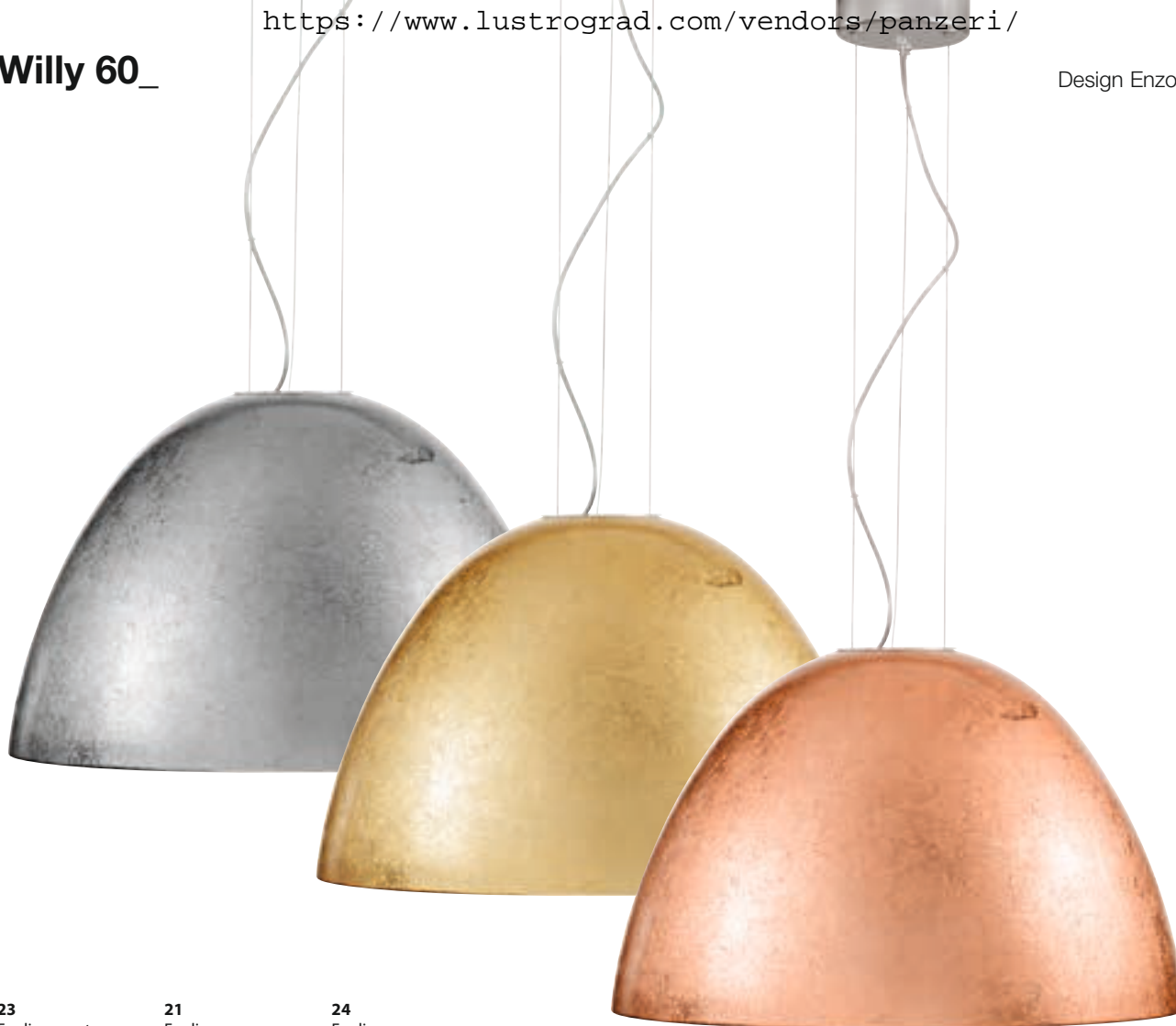

23
Foglia argento
Silver leaf

21
Foglia oro
Gold leaf

24
Foglia rame
Copper leaf

Willy 60_

design_Enzo Panzeri 2009

LED CE IP20

Alluminio / Aluminium

Energy Label available at www.panzeri.it

Disponibile anche in versione LED / LED version available

220 / 240 V

	CODICE / CODE	CM Ø	H	INCHES Ø	H	FLUO	HALO
Sospensione / Suspension	L 7610.60 GLOSSY	60	37 - max 237	23 5/8"	14 5/8" - max 93 3/8"	3x max 30W Superstar E27	3x max 100W E27
	L 7610.60 GLOSSY HI	60	37 - max 237	23 5/8"	14 5/8" - max 93 3/8"		70W E27 HCl / HQI
	L 7621.60 GOLD	60	37 - max 237	23 5/8"	14 5/8" - max 93 3/8"	3x max 30W Superstar E27	3x max 100W E27
	L 7633.60 ALU	60	37 - max 237	23 5/8"	14 5/8" - max 93 3/8"	3x max 30W Superstar E27	3x max 100W E27
	L 7633.60 ALU HI	60	37 - max 237	23 5/8"	14 5/8" - max 93 3/8"		70W E27 HCl / HQI
	L 7634.60 ALU	60	37 - max 237	23 5/8"	14 5/8" - max 93 3/8"	3x max 30W Superstar E27	3x max 100W E27
	L 7634.60 ALU HI	60	37 - max 237	23 5/8"	14 5/8" - max 93 3/8"		70W E27 HCl / HQI

Fotometrie disponibili www.panzeri.it / Photometric data available at www.panzeri.it

CODICI COLORI DISPONIBILI / COLOURS CODES AVAILABLE

10 Bianco lucido
Glossy white

21 Foglia oro
Gold leaf

23 Foglia argento (a richiesta)
Silver leaf (available on request)

24 Foglia rame (a richiesta)
Copper leaf (available on request)

33 Grigio metallizzato
Metallized grey

34 Grigio micaceo
Micaceous grey



Willy60_









Sospensione in polietilene con montatura grigia metallizzata e diffusore in lastra di vetro. Anche in versione con alogenuri metallici e LED.

Suspension of polyethylene with fittings in metallized grey metal and glass sheet as diffuser. Also available model with metal halide lamps and LED.

Hängeleuchte aus Polyäthylen mit Struktur in graumetall und Glasscheibe. Auch mit Metalldampflampen und LED verfügbar.

Suspensión en polietileno con montura gris metalizado y difusor en lastra de vidrio. Disponible en la versión con bombilla de alogenuro metálico y LED también.

Suspension en polyéthylène avec monture gris métallisée et diffuseur en plaque de verre. Version avec lampes aux halogénures métalliques et LED aussi.

Подвесной светильник из полиэтилена с арматурой цвета серый металл и стеклянным диффузором. Также доступны версии с металлогалогенной лампой и на LED.



Willy 100_

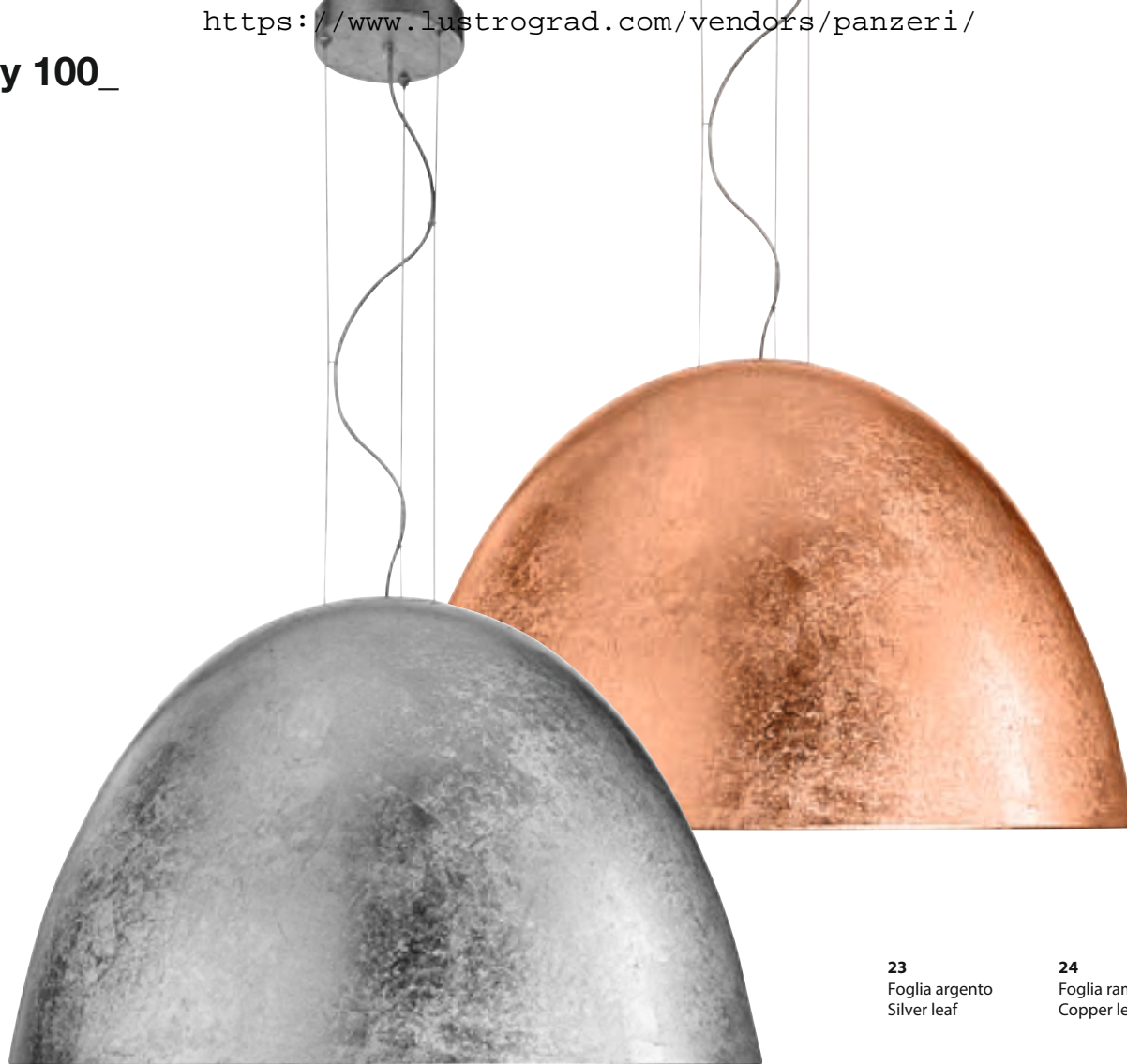

23
Foglia argento
Silver leaf

24
Foglia rame
Copper leaf

Willy 100_

design_Enzo Panzeri 2007

LED CE IP20

Polietilene / Polyethylene

Energy Label available at www.panzeri.it

Disponibile anche in versione LED / LED version available

220 / 240 V

	CODICE / CODE	CM Ø	H	INCHES Ø	H	FLUO	HALO
Sospensione / Suspension	L 7633.100	100	63 - max 263	39 3/8"	24 3/8" - max 103 1/2"	4x max 30W Superstar E27	4x max 100W E27
	L 7633.100 HI	100	63 - max 263	39 3/8"	24 3/8" - max 103 1/2"		150W E27 HCl / HQI
	L 7621.100 GOLD	100	63 - max 263	39 3/8"	24 3/8" - max 103 1/2"	4x max 30W Superstar E27	4x max 100W E27
	L 7621.100 GOLD HI	100	63 - max 263	39 3/8"	24 3/8" - max 103 1/2"		150W E27 HCl / HQI
	L 7633.100 BLACK	100	63 - max 263	39 3/8"	24 3/8" - max 103 1/2"	4x max 30W Superstar E27	4x max 100W E27
	L 7633.100 BLACK HI	100	63 - max 263	39 3/8"	24 3/8" - max 103 1/2"		150W E27 HCl / HQI

Fotometrie disponibili www.panzeri.it / Photometric data available at www.panzeri.it

CODICI COLORI DISPONIBILI / COLOURS CODES AVAILABLE

21 Foglia oro_Foglia oro
Gold leaf_Gold leaf

23 Foglia argento_Foglia argento
(a richiesta)
Silver leaf_Silver leaf
(available on request)

24 Foglia rame_Foglia rame
(a richiesta)
Copper leaf_Copper leaf
(available on request)

33 Grigio metallizzato_Bianco
Metallized grey_White

33 Grigio metallizzato_Nero
Metallized grey_Black



Ventitrentatre_



Sospensione a LED in alluminio estruso verniciato bianco, nero con riflettore e schermo.

Suspension LED in extruded aluminium, painted white, black with reflector and screen.

LED-Pendelleuchte aus extrudiertem Aluminium, weiß lackiert, schwarz mit Reflektor und Schirm.

Suspensión con LED de aluminio extruso barnizado blanco, negro con reflector y pantalla.

Suspension à LED en aluminium extrudé peint en blanc, noir avec réflecteur et écran.

Подвесной светодиодный светильник из экструдированного алюминия окрашенного в белый или чёрный цвет с отражателем и экраном.



Ventitrentatre_





Ventitrentatre_



Ventitrentatre_

 **CE** IP20

Energy Label available at www.panzeri.it

220 / 240 V

	CODICE / CODE	CM A x B	H	INCHES A x B	H	LED
Sospensione / Suspension	L 2033.100 LED	102 x 3,5	3,5	40 1/2" x 1 3/8"	1 3/8"	17W 3000K Ra 80 2150lm
	L 2033.150 LED	152 x 3,5	3,5	59 5/8" x 1 3/8"	1 3/8"	25,5W 3000K Ra 80 3225lm
	L 2033.100 LED BLA	102 x 3,5	3,5	40 1/2" x 1 3/8"	1 3/8"	17W 3000K Ra 80 2150lm
	L 2033.150 LED BLA	152 x 3,5	3,5	59 5/8" x 1 3/8"	1 3/8"	25,5W 3000K Ra 80 3225lm

Fotometrie disponibili www.panzeri.it / Photometric data available at www.panzeri.it



Ventitrentacinque_

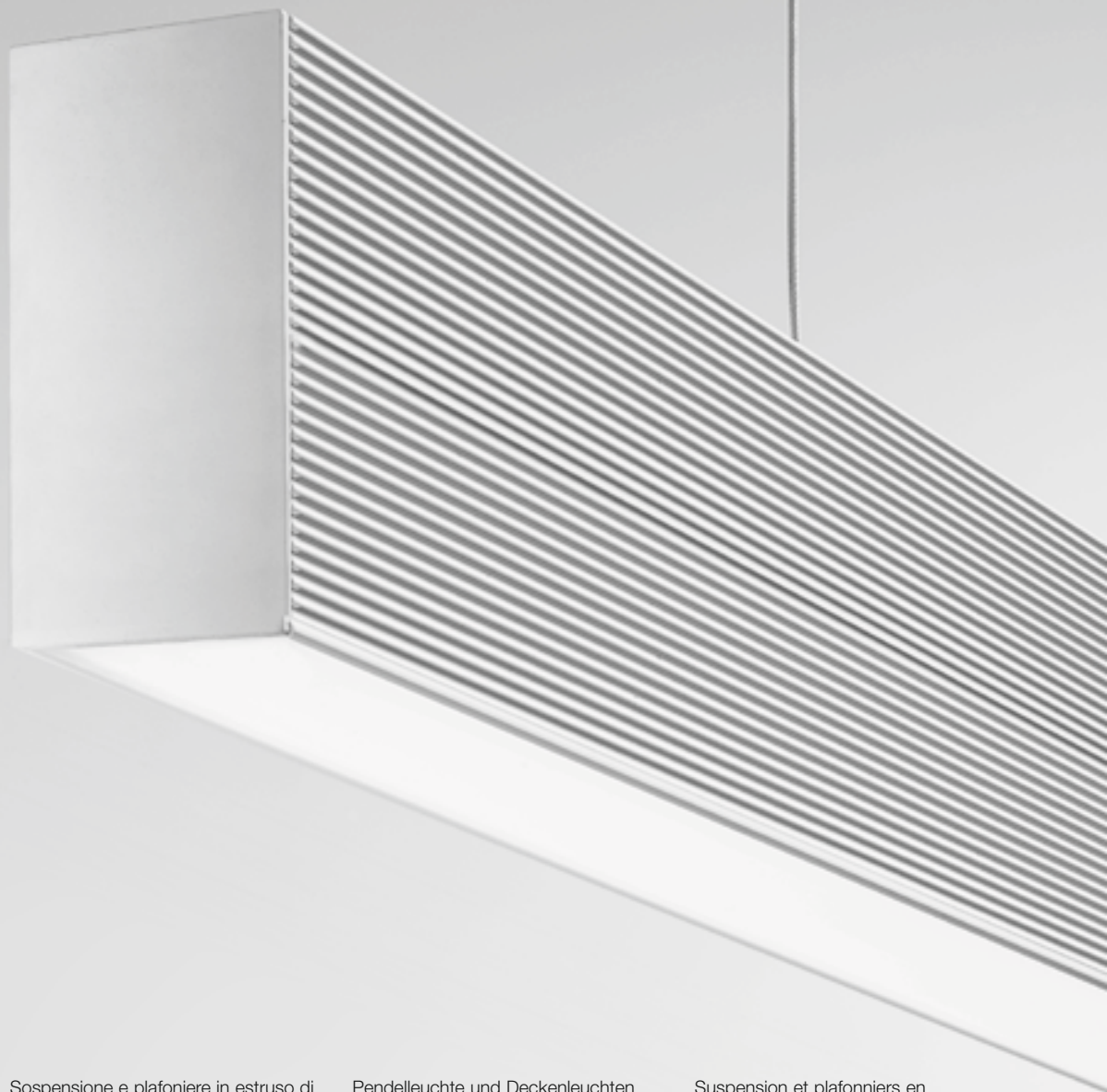

Sospensione e plafoniere in estruso di alluminio verniciato bianco. Complete di portalampada, reattore elettronico, riflettore e lampadina fluo SLS G5.

Suspension and ceiling lights made of extruded aluminium, painted white. Complete with lamp, electronic ballast, reflector and fluorescent bulb SLS G5.

Pendelleuchte und Deckenleuchten aus extrudiertem Aluminium, weiß lackiert. Mit Lampenfassung, elektronischem Reaktor, Reflektor und Leuchtstofflampe SLS G5.

Suspensión y plafones en extruso de aluminio barnizado blanco. Completas de portalámpara, reactor electrónico, reflector y bombilla fluo SLS G5.

Suspension et plafonniers en aluminium extrudé peint en blanc. Livrés avec douille, réacteur ballast électronique, le réflecteur et l'ampoule fluorescente G5 SLS.

Подвесной и потолочные светильники из экструдированного алюминия окрашенного в белый цвет. Патрон, электронный балласт, отражатель и люминесцентная лампа SLS G5 входят в комплект.





Ventitrentacinque_



Ventitrentacinque_

CE IP20

Energy Label available at www.panzeri.it

220 / 240 V

FLUO

	CODICE / CODE	CM A x B	H	INCHES A x B	H	
Sospensione / Suspension	L 2035.120	119 x 3,5	7,5	46 7/8" x 1 3/8"	3"	54W/830 HO54SLS G5
Soffitto / Ceiling	P 2035.120	119 x 3,5	7,5	46 7/8" x 1 3/8"	3"	54W/830 HO54SLS G5

Fotometrie disponibili www.panzeri.it / Photometric data available at www.panzeri.it

One_

Design_Team Design 2010



Lampade da sospensione e plafone in tubo tondo di alluminio nei colori: bianco, marrone metallizzato, alluminio sabbiato, foglia oro. A richiesta foglia argento o rame. Disponibile anche in versione LED.

Suspension and ceiling lamp in round aluminium tube. White, metallized brown, sanded aluminium, gold leaf. On request silver or copper leaf. LED version also available.

Hänge-und Deckenleuchte in Aluminium Rundrohr. Weiß, Braunmetall, sandgestrahlte Aluminium, Blattgold. Auf Anfrage Blattsilber oder Blattkupfer. Hängeleuchte auch in LED-Ausführung.

Lámpara de mesa, de techo en tubo redondo de aluminio. Blanco, marrón metalizado, aluminio arenado, pan de oro. A petición pan de plata o pan de cobre. Disponible también en versión LED.

Plafonnier et suspension en tube rond en aluminium. Blanc, brun métallisé, aluminium sablé, feuille d'or. Sur demande feuille d'argent ou cuivre. Disponible aussi en version LED.

Подвесные и потолочные светильники из круглой алюминиевой трубы. Доступны отделки: белый, коричневый металл, матовый алюминий, сусальное золото. Сусальное серебро и сусальная медь доступны по запросу. Также доступна версия на LED.



One_



Teatro Astra - San Donà di Piave, VE, Italia
Arch. Gonçalo Byrne



"One" Custom





One_



One_

design_Team Design 2010

LED CE IP20 (IP40-LED) (LED)

Energy Label available at www.panzeri.it

220 / 240 V

	CODICE / CODE	CM Ø	H	INCHES Ø	H	LED	HALO
Sospensione / Suspension	L 37__ LED	10,5	38	4 1/8"	15"	13W 3000K Ra 80 1210lm	
Sospensione / Suspension	L 37__	10,5	38	4 1/8"	15"		Max 75W Halopar 30 E27
Soffitto / Ceiling	P 37__ LED	10,5	21	4 1/8"	8 1/4"	13W 3000K Ra 80 1210lm	
Soffitto / Ceiling	P 37__	10,5	21	4 1/8"	8 1/4"		Max 75W Halopar 30 E27

Fotometrie disponibili www.panzeri.it / Photometric data available at www.panzeri.it

CODICI COLORI DISPONIBILI / COLOURS CODES AVAILABLE

01 Bianco
White

21 Foglia oro
Gold leaf

23 Foglia argento (a richiesta)
Silver leaf (available on request)

24 Foglia rame (a richiesta)
Copper leaf (available on request)

35 Alluminio sabbato
Sanded aluminium

44 Marrone metallizzato
Metallized brown





Lampade da sospensione e plafone in tubo quadro di alluminio nei colori: bianco, marrone metallizzato, alluminio sabbato, foglia oro. A richiesta foglia argento o rame. Disponibile anche in versione LED.

Suspension and ceiling lamp in squared aluminium tube. White, metallized brown, sanded aluminium, gold leaf. On request silver and copper leaf. LED version also available.

Hänge-und Deckenleuchte in Aluminium Vierkantröhr. Weiß, Braunmetall, sandgestrahlte Aluminium, Blattgold. Auf Anfrage Blattsilber oder Blattkupfer. Hängeleuchte auch in LED-Ausführung.

Lámpara de mesa, de techo en tubo cuadrado de aluminio. Blanco, marrón metalizado, aluminio arenado, pan de oro. A petición pan de plata o pan de cobre. Disponible también en versión LED.

Plafonnier et suspension en tube carré en aluminium. Blanc, brun métallisé, aluminium sablé, feuille d'or. Sur demande feuille d'argent ou cuivre. Disponible aussi en version LED.

Подвесные и потолочные светильники из квадратной алюминиевой трубы. Доступны в отделках: белый, коричневый металл, матовый алюминий, сусальное золото. Сусальное серебро и сусальная медь доступны по запросу. Также доступна версия на LED.



Two_





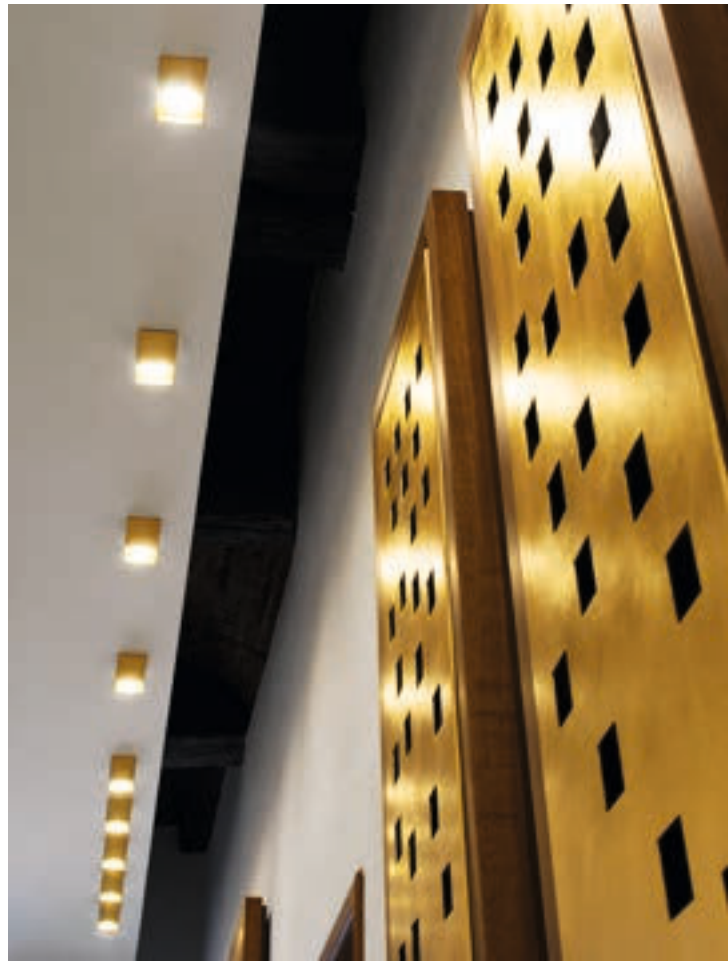

Misuri store - Firenze, Italia



Two_



Two_

design_Team Design 2010

LED CE IP20 (IP40-LED) (LED)

Energy Label available at www.panzeri.it

220 / 240 V

	CODICE / CODE	CM A x B	H	INCHES A x B	H	LED	HALO
Sospensione / Suspension	L 38_ _ LED	8 x 8	38	3 1/8" x 3 1/8"	15"	13W 3000K Ra 80 1210lm	
Sospensione / Suspension	L 38_ _	8 x 8	38	3 1/8" x 3 1/8"	15"		Max 75W Halopar 20 GU10
Soffitto / Ceiling	P 38_ _ LED	8 x 8	8,7	3 1/8" x 3 1/8"	3 1/2"	13W 3000K Ra 80 1210lm	
Soffitto / Ceiling	P 38_ _ N	8 x 8	8,7	3 1/8" x 3 1/8"	3 1/2"		Max 50W Halopar 16 GU10

Fotometrie disponibili www.panzeri.it / Photometric data available at www.panzeri.it

CODICI COLORI DISPONIBILI / COLOURS CODES AVAILABLE

0 1 Bianco
White

2 1 Foglia oro
Gold leaf

2 3 Foglia argento (a richiesta)
Silver leaf (available on request)

2 4 Foglia rame (a richiesta)
Copper leaf (available on request)

3 5 Alluminio sabbaiato
Sanded aluminium

4 4 Marrone metallizzato
Metallized brown



Three_

Design_Team Design 2011

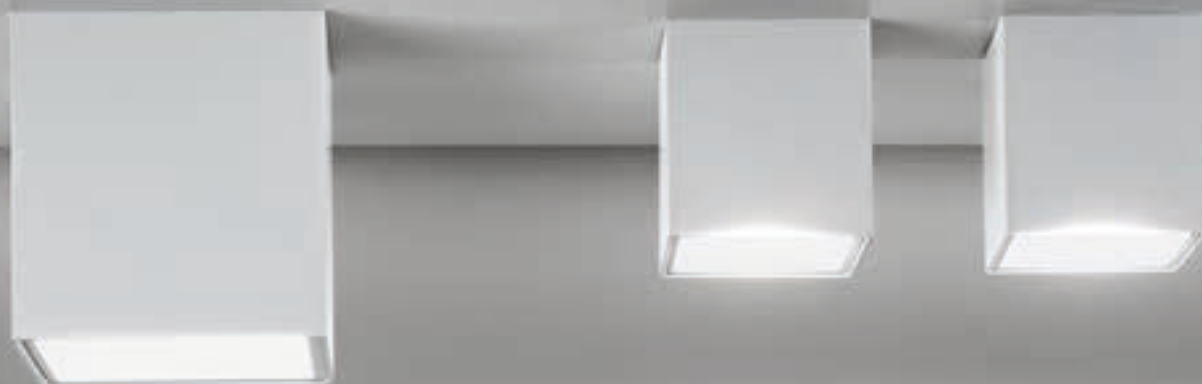

Lampada da parete/plafone in alluminio e vetro nei colori: bianco, marrone metallizzato e alluminio sabbiato. Disponibile anche in versione LED.

Wall/ceiling lamp in aluminium and glass: white, metallized brown and sanded aluminium. LED version also available.

Wand-Deckenleuchte in Aluminium und Glas: Weiß, Braunmetallisch und Sandgestrahlte Aluminium. Hängeleuchte auch in LED-Ausführung.

Lámpara de pared/techo en aluminio y vidrio. Blanco, marrón metalizado y aluminio arenado. Disponible también en versión LED.

Applique/plafonnier en aluminium et verre. Blanc, brun métallisé, aluminium sablé. Disponible aussi en version LED.

Бра/потолочный светильник из алюминия и стекла, цвета: коричневый металл, белый, матовый алюминий. Возможен вариант со светодиодной лампой.





Three_



Three_

design_Team Design 2011

Registered Design

LED CE IP40 (LED)

Energy Label available at www.panzeri.it

220 / 240 V

	CODICE / CODE	CM A x B	H	INCHES A x B	H	LED	FLUO	HALO
Soffitto-parete / Ceiling-wall	P 39_ _N LED	11 x 11	11	4 1/2" x 4 1/2"	4 1/2"	13W 3000K Ra 80 1210lm		
	P 39_ _N	11 x 11	11	4 1/2" x 4 1/2"	4 1/2"			Max 50W Halopar 16 GU10
	P 39_ _N XL LED	15 x 15	15	6" x 6"	6"	17,5W 3000K Ra 80 1590lm		
	P 39_ _N XL	15 x 15	15	6" x 6"	6"		Max 23W Micro Twist E27	Max 77W E27

Fotometrie disponibili www.panzeri.it / Photometric data available at www.panzeri.it

CODICI COLORI DISPONIBILI / COLOURS CODES AVAILABLE

01 Bianco
White

35 Alluminio sabbaiato
Sanded aluminium

44 Marrone metallizzato
Metallized brown



Four_

Design_Team Design 2011



Lampada da parete/plafone IP65 in fusione di alluminio e fronte in acciaio MARINO AISI 316 verniciato marrone metallizzato o bianco con vetro frontale. Disponibile anche in versione LED.

Wall/ceiling lamp IP65 in aluminium casting. Brown metallized or white stainless MARINE AISI 316 and mat glass. LED version also available.

Wand-/Deckenleuchte IP65 aus Aluminiumguss und MARINE Stahl AISI 316 braunmetallisch oder weiß. Mattglas. Hängeleuchte auch in LED-Ausführung.

Lámpara de pared/techo IP65 en fusión de aluminio. MARINAS de acero AISI 316 marrón metalizado o blanco. Vidrio soplado. Disponible también en versión LED.

Applique/Plafonnier IP65 en fonte de aluminium. En acier inox MARINE AISI 316 brun métallisé ou blanc avec verre satiné. Disponible aussi en version LED.

Настенно — потолочный светильник IP65 из литого алюминия. Отделки: белый, коричневый металллик MARINE AISI 316 и матовое стекло.





Four_

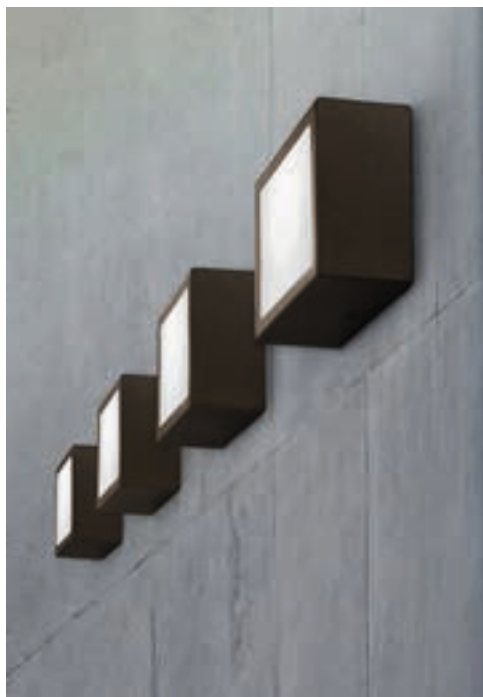



Four_

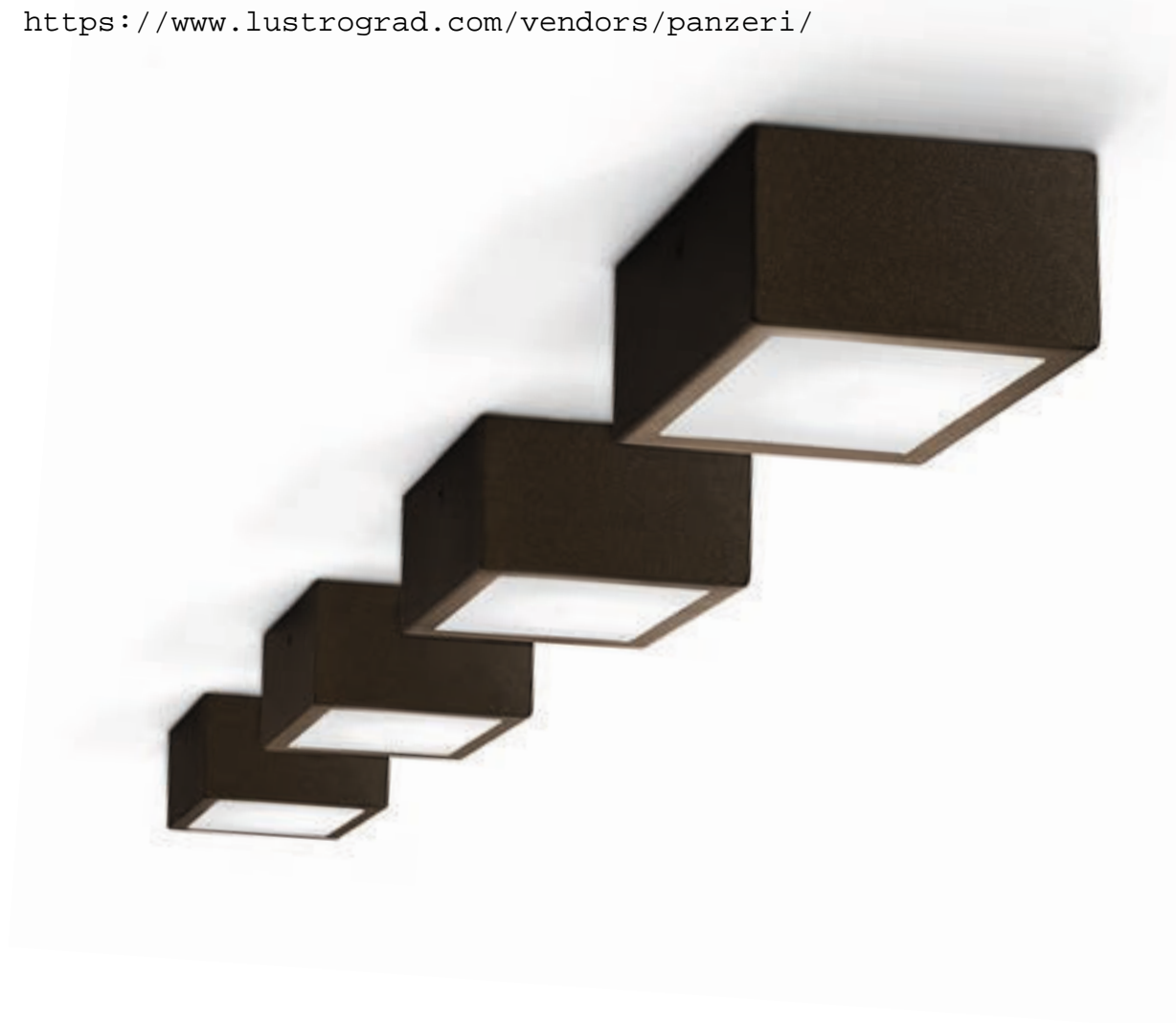

Four_	design_Team Design 2011					
				Energy Label available at www.panzeri.it		
				220 / 240 V		
	CODICE / CODE	CM A x B	H	INCHES A x B	H	
Soffitto-parete / Ceiling-wall	EP 44_ _ LED	12 x 12	6	4 3/4" x 4 3/4"	2 3/8"	13W 3000K Ra 80 1210lm
	EP 44_ _	12 x 12	6	4 3/4" x 4 3/4"	2 3/8"	max Nano TW 9W G9 max 33W G9

Fotometrie disponibili www.panzeri.it / Photometric data available at www.panzeri.it

CODICI COLORI DISPONIBILI / COLOURS CODES AVAILABLE

01 Bianco
White

44 Marrone metallizzato
Metallized brown



Acheos_

Design_Enzo Panzeri 2012



Lampada da parete in metallo bianco.
Disponibile in versione alogena o LED.

Wall lamp in white.
Available in halogen or LED versions.

Wandleuchte aus weißem Metall.
Als Halogen- oder LED-Leuchte
verfügbar.

Lámpara de pared de metal blanco.
Disponibile en versión halógena o LED.

Applique en métal blanc. Disponible en
version halogène ou LED.

Настенный металлический светильник
белого цвета. Доступен в версиях на
галогенных лампах или на LED.



Acheos_





Acheos_

design_Enzo Panzeri 2012

  IP20

Energy Label available at www.panzeri.it

220 / 240 V

	CODICE / CODE	CM A x B	H	INCHES A x B	H	LED	HALO
Parete / Wall	A 6001 LED	12,5 x 10	6	5" x 4"	2 3/8"	13W 3000K Ra 80 1300lm	
	A 6001 HALO	12,5 x 10	6	5" x 4"	2 3/8"		max 120W R7s 78mm

Fotometrie disponibili www.panzeri.it / Photometric data available at www.panzeri.it

CODICI COLORI DISPONIBILI / COLOURS CODES AVAILABLE

01 Bianco
White



Domino_

Design_Yohji Terazeri 2005



Lampade da parete/soffitto, da sospensione, da terra, da tavolo verniciate in grigio metallizzato. Vetro soffiato bianco satinato e nero. Nelle versioni a vetri multipli (lampada da terra e parete/soffitto) le combinazioni colori disponibili sono bianco/bianco e bianco/nero. Disponibile anche in versione foglia oro. A richiesta foglia argento o foglia rame.

Suspensions, wall/ceiling, table, floor lamp in metallized grey metal. Blown white mat glass and black. In multiple glasses versions (floor and wall/ceiling lamp) available combinations are white/white and white/black. Gold leaf version also available. On request silver or copper leaf version.

Hänge-, Wand-/Decken-, Steh-, Tischleuchten in graumetallic. Mundgeblasenes Glas weiß satiniert oder schwarz. Zusätzliche Glasfarben-Kombinationen (Steh- und Wand-/Deckenleuchten) sind weiß/weiß und weiß/schwarz. Blattgold- ausführung ebenfalls zur Verfügung. Auf Anfrage Blattsilber oder Blattkupfer.

Lámpara de suelo, de mesa, de pared/plafón y suspensión en gris metalizado. Vidrio soplado blanco satinado y negro. Combinación de colores por lámpara de suelo, de pared/plafónes son blanco/blanco y blanco/negro. Versión pan de oro también disponible. A petición version pan de plata o pan de cobre.

Suspensions, lampe au sol, de table et applique/plafonniers en gris métallisé. Verre soufflé blanc satiné et noir. Combinaisons de couleurs pour lampe au sol et appliques/plafonniers sont blanc/blanc et blanc/noir. Version feuille d'or aussi disponible. Sur demande version feuille d'argent ou feuille de cuivre.

Подвесные, настенно-потолочные, настольные и напольные светильники с арматурой цвета серый металл. Выдувное белое матовое и черное стекло. В моделях с несколькими плафонами (напольные и настенно-потолочные светильники) доступны комбинации цветов стекол: белое/белое и белое/черное. Возможна отделка сусальным золотом. Сусальное серебро и сусальная медь по запросу.





Noa Restoran - Tallin, Estonia



Domino_





Domino_



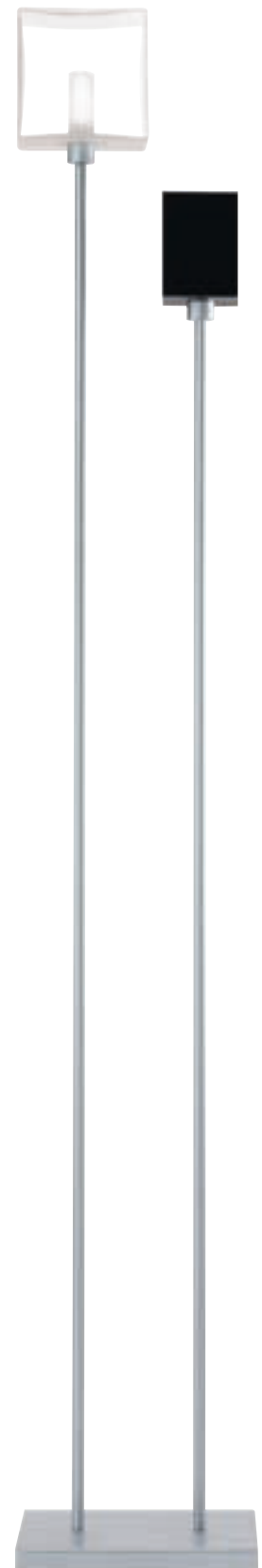

Domino_







Domino_

design_Yohji Terazeri 2005

CE IP40 (☐ Table / Floor) ⚡

Energy Label available at www.panzeri.it

	CODICE / CODE	CM A x B	H	INCHES A x B	H	HALO
Sospensione / Suspension	L 90__11	11 x 8	26	4 ¼" x 3 ⅞"	10 ¼"	max 60W G9
	L 90__14	14 x 9	29	5 ½" x 3 ½"	11 ½"	max 60W G9
Soffitto / Ceiling	P 90__11	11 x 8	13	4 ¼" x 3 ⅞"	5 ⅞"	max 60W G9
	P 90__14	14 x 9	16	5 ½" x 3 ½"	6 ¼"	max 60W G9
	P 90__ - 2	23 x 23	16	9" x 9"	6 ¼"	2x max 60W G9
	P 90__ - 4	28 x 24	16	11" x 9 ½"	6 ¼"	4x max 60W G9
	P 90__ - 9	45 x 43	19	17 ¾" x 17"	7 ½"	9x max 33W G9
Tavolo / Table	C 90__	11 x 8	13	4 ¼" x 3 ⅞"	5 ⅞"	max 60W G9
Terra / Floor	T 90__	25	165	9 ⅞"	65"	2x max 60W G9

CODICI COLORI DISPONIBILI / COLOURS CODES AVAILABLE

2 1 Foglia oro
Gold leaf

2 3 Foglia argento (a richiesta)
Silver leaf (available on request)

2 4 Foglia rame (a richiesta)
Copper leaf (available on request)

3 3 Grigio metallizzato
Metallized grey



WHITE



BLACK



W/W WHITE/WHITE



W/B WHITE/BLACK



Domino inox_

Design_Yohji Terazeri 2006

Lampade da parete/soffitto in acciaio inox con montatura grigia metallizzata con vetri di protezione.

Wand-/Deckenleuchten aus Edelstahl und Struktur graumetallic mit Schutzgläsern.

Appliques/plafonniers en acier inoxydable. Monture en gris métallisé avec de verres de protection.

Ceiling/wall lamps in stainless steel and metallized grey metal part and protection glasses.

Pared/plafones de acero inoxidable y montura de metal gris con vidrios de protección.

Потолочные/настенные светильники из нержавеющей стали с арматурой в цвете серый металлик, с защитными стеклами.





Domino inox_

Domino inox_

design_Yohji Terazeri 2006

CE IP20 

Energy Label available at www.panzeri.it

	CODICE / CODE	CM A x B	H	INCHES A x B	H	HALO
Soffitto / Ceiling	P 1037.11	11 x 8	13	4 ¼" x 3 ⅛"	5 ⅛"	max 60W G9
	P 1037.14	14 x 9	16	5 ½" x 3 ½"	6 ¼"	max 60W G9
	P 1037 - 2	23 x 23	16	9" x 9"	6 ¼"	2x max 60W G9

CODICI COLORI DISPONIBILI / COLOURS CODES AVAILABLE

37 Acciaio inox lucido
Polished stainless steel



Zero_

Design_Team Design 2012



Lampade da parete/soffitto in metallo bianco, marrone metallizzato, cromo, rame lucido e foglia oro completa di LED e driver. A richiesta foglia argento o foglia rame.

Wall/ceiling lamps in white metal, metallic brown, chrome, polished copper and gold leaf complete with LED and driver. On request silver or copper leaf.

Wand-/Deckenleuchten aus weißem Metall, braun metallisiert, Chrom, Kupfer glänzend und Blattgold mit LED und Treiber. Auf Anfrage Blattsilber oder Blattkupfer.

Lámpara de pared /de techo de metal blanco, marrón metalizado, cromo, cobre lúcido y pan de oro completa de LED y de driver. A petición pan de plata o pan de cobre.

Appliques/plafonniers en métal blanc, marron métallisé, chrome, cuivre brillant et feuille or avec LED et driver. Sur demande feuille d'argent ou cuivre.

Настенно — потолочные светильники. Доступные отделки: белый, коричневый металл, хром, медь и сусальное золото. LED и LED драйвер входят в комплект.



Zero_







Zero_





Zero_



Zero_	design_Team Design 2012	Registered Design	IP20
			Energy Label available at www.panzeri.it
			220 / 240 V
	CODICE / CODE	CM A x B H	INCHES A x B H
			LED
Parete / Wall	A 35_-.50 LED	52 x 7,5 3	L 20 1/2" x 3" 1 1/2"
	A 35_-.100 LED	102 x 7,5 3	L 40 1/2" x 3" 1 1/2"
			8,5W 3000K Ra 80 1075lm
			17W 3000K Ra 80 2150lm

Fotometrie disponibili www.panzeri.it / Photometric data available at www.panzeri.it

CODICI COLORI DISPONIBILI / COLOURS CODES AVAILABLE

01 Bianco White	21 Foglia oro Gold leaf	22 Cromo Chrome	23 Foglia argento (a richiesta) Silver leaf (available on request)	24 Foglia rame (a richiesta) Copper leaf (available on request)	25 Rame lucido Polished copper	44 Marrone metallizzato Metallized brown
---------------------------	-----------------------------------	---------------------------	--	---	--	--





Lampada da parete a LED in bianco, nero, ottone cromato e rame lucido con montatura a scomparsa oppure esterna.

LED wall lamp in white, black, chrome plated brass and polished copper with recessed or external fitting.

LED-Wandleuchte aus weiß, schwarz, verchromtem Messing und Kupfer glänzend mit eingebautem oder externem Struktur.

Lámpara de pared LED blanco, negro de latón cromado y cobre lúcido con montura corredera empotrada o externa.

Applique à LED en blanc, noir, laiton chromé et cuivre brillant avec cadre caché ou externe.

Настенный светильник на LED. Доступны отделки: белый, черный, хром, и медь. Встраиваемый либо накладной.









Ypsilon_



Ypsilon_

design_Team Design 2013

LED **CE** **IP20**

Energy Label available at www.panzeri.it

220 / 240 V

	CODICE / CODE	CM A x B	H	INCHES B	H	LED
Parete / Wall	A 72_ _ OUT	3 x 14,5	62	1 1/8" x 5 7/8"	24 3/8"	12W 3000K Ra 80 1460lm
	A 72_ _ IN	3 x 11	62	1 1/8" x 4 1/8"	24 3/8"	12W 3000K Ra 80 1460lm

Fotometrie disponibili www.panzeri.it / Photometric data available at www.panzeri.it

CODICI COLORI DISPONIBILI / COLOURS CODES AVAILABLE

- 01** Bianco
White
- 02** Nero
Black
- 22** Cromo
Chrome
- 25** Rame lucido
Polished copper





Sospensioni, plafoniere e lampada da tavolo in vetro bianco soffiato con montatura in metallo verniciato bianco. Disponibile anche in versione LED.

Suspension, ceiling lamps and table lamp in white blown glass with a metal fitting painted white. LED version also available.

Hänge-, Decken- und Tischleuchten aus weißem, mundgeblasenem Glas mit weiß lackiertem Metallstruktur. Leuchten auch in LED-Ausführung.

Suspensiones, plafones y lampara de mesa de cristal blanco soplado con montura de metal barnizado blanco. Disponible también en versión LED.

Suspensions, plafonniers et lampe de table en verre soufflé blanc avec cadre en métal peint blanc. Disponible aussi en version LED.

Подвесные, потолочные и настольные светильники из белого выдувного стекла, металлическая арматура окрашена в белый цвет. LED версия также доступна.











Gilbert_



Gilbert_

design_Team Design 2013



Energy Label available at www.panzeri.it

220 / 240 V

	CODICE / CODE	CM Ø	H	INCHES Ø	H	LED	FLUO	HALO
Sospensione / Suspension	L 6501.22 LED	22	14	8 2/3"	5 1/2"	9,5W 3000K Ra 80 1000lm		
	L 6501.22	22	14	8 2/3"	5 1/2"			max 60W G9
	L 6501.37 LED	37	27	14 4/5"	10 2/3"	31W 3000K Ra 80 3250lm		
	L 6501.37	37	27	14 4/5"	10 2/3"		max 18W Micro Twist E27	max 150W E27
	L 6501.45 LED	45	33	17 3/4"	13"	31W 3000K Ra 80 3250lm		
	L 6501.45	45	33	17 3/4"	13"		max 23W Micro Twist E27	max 150W E27
Soffitto / Ceiling	P 6501.37 LED	37	27	14 4/5"	10 2/3"	24W 3000K Ra 80 2250lm		
	P 6501.37	37	27	14 4/5"	10 2/3"		max 18W Micro Twist E27	max 150W E27
	P 6501.45 LED	45	33	17 3/4"	13"	24W 3000K Ra 80 2250lm		
	P 6501.45	45	33	17 3/4"	13"		max 23W Micro Twist E27	max 150W E27
Tavolo / Table	C 6501.22 LED	22	14	8 2/3"	5 1/2"	8W 3000K Ra 80 1080lm		

Fotometrie disponibili www.panzeri.it / Photometric data available at www.panzeri.it

CODICI COLORI DISPONIBILI / COLOURS CODES AVAILABLE

01 Bianco
White



Flat_

Design_Enzo Panzeri 2014



Plafoniere LED in metallo bianco o marrone metallizzato a luce diretta. Disponibile versione incasso cm 60x60 da appoggio **per controsoffitti modulari standard**. Sospensione LED in metallo bianco o marrone metallizzato a luce diretta e indiretta. Perimetro luminescente. A richiesta foglia oro, foglia argento o foglia rame.

LED ceiling lamp in white metal or in metallic brown, providing direct light. Recessed resting version 60x60 cm available **for standard ceiling suspensions**. LED suspension lamp in white metal or in metallic brown, providing direct and indirect light. Luminescent perimeter. On request gold, silver or copper leaf.

LED-Deckenleuchten aus Metall, in Weiß und Braun metallisiert mit direkter Beleuchtung. Lieferbar als Aufsatz-Einbauleuchte cm 60x60 **für Systemzwischendecken**. LED-Pendelleuchte aus Metall, in Weiß und Braun metallisiert mit direkter und indirekter Beleuchtung. Leuchtstoff-Umfang. Auf Anfrage Blattgold, Blattsilber oder Blattkupfer.

Plafones LED en metal blanco y marrón metalizado con luz directa. Disponible versión empotrable cm 60x60 de apoyo **para falsos techos modulares standard**. Suspensión LED en metal blanco y marrón metalizado con luz directa e indirecta. Perimetro luminiscente. A petición pan de oro, pan de plata o pan de cobre.

Plafond LED en métal blanc ou en brun métallique avec la lumière directe. Disponible version encastrée cm 60x60 en support **en faux-plafonds modulaires**. Suspension LED en métal blanc ou en brun métallique avec la lumière directe et indirecte. Périimètre luminescent. Sur demande feuille d'or, feuille d'argent ou feuille de cuivre.

Потолочный LED светильник прямого света. Доступные отделки металла: белый или коричневый металл. Доступна встраиваемая версия 60x60см. Подвесной LED светильник прямого и отраженного света. Доступные отделки металла: белый или коричневый металл. Светится по периметру. Отделки: сусальное золото, сусальное серебро и сусальная медь доступны по запросу.



Flat_





Flat_





Uffici Direzionali - Mi, Italia









Flat_



Flat_ design_Enzo Panzeri 2014 LED CE IP40

Energy Label available at www.panzeri.it

220 / 240 V

	CODICE / CODE	CM A x B	H	INCHES A x B	H	LED
Sospensione / Suspension	L 75_..51	51 x 51	4,5	20" x 20"	1 7/8"	46W+11,5W 3000K Ra 80 4800lm+1200lm dimmable driver 
Soffitto / Ceiling	P 75_..38	38 x 38	4,5	15" x 15"	1 7/8"	24W 3000K Ra 80 2920lm
	P 75_..51	51x51	4,5	20" x 20"	1 7/8"	46W 3000K Ra 80 4800lm dimmable driver 
Soffitto-incasso / Ceiling recessed	P 75_..60 IN	59,5 x 59,5	6	23 3/8" x 23 3/8"	2 3/8"	46W 3000K Ra 80 4800lm

Modalità di installazione ad incasso in appoggio in controsoffitti modulari / Resting recessed installation into modular suspended ceilings

Soffitto-incasso / Ceiling recessed	P 75_..60 IN EM	59,5 x 59,5	6	23 3/8" x 23 3/8"	2 3/8"	46W 3000K Ra 80 4800lm 
-------------------------------------	------------------------	-------------	---	-------------------	--------	--

Modalità di installazione ad incasso in appoggio in controsoffitti modulari / Resting recessed installation into modular suspended ceilings

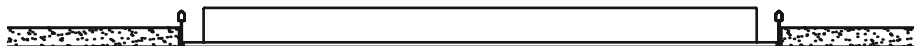

Fotometrie disponibili www.panzeri.it / Photometric data available at www.panzeri.it

CODICI COLORI DISPONIBILI / COLOURS CODES AVAILABLE

- | | | | | |
|----------------------------|---|---|--|---|
| 0 1 Bianco
White | 2 1 Foglia oro (a richiesta)
Gold leaf (available on request) | 2 3 Foglia argento (a richiesta)
Silver leaf (available on request) | 2 4 Foglia rame (a richiesta)
Copper leaf (available on request) | 4 4 Marrone metallizzato
Metallized brown |
|----------------------------|---|---|--|---|



Blanca_

Design_Federico Churba 2012



Sospensione a LED dimmerabile di ultima generazione. Alluminio tornito verniciato bianco lucido e marrone metallizzato con diffusore in polimetilmetacrilato (PMMA) opale.

Suspension in LED dimmable version of the latest generation. Glossy white and brown metallized turned aluminium piece and opal polymethylmethacrylate (PMMA) diffuser.

Hängeleuchte in LED version dimmable der neuesten Generation. Glänzend weiße und braunmetallisch gefräste Aluminium Stück und opal Polymethylmethacrylat (PMMA) Schirm.

Suspensión con LED version dimmable de última generación. Pieza de aluminio tornado blanco brillante y marrón metalizado y difusor en opal polimetilmetacrilato (PMMA). Disponible también la versión Ø 90 cm dimmable.

Suspension avec LED version dimmable de dernière génération. Pièce en aluminium tourné blanc brillant et brun métallisé et diffuseur en opal polyméthacrylate (PMMA).

Подвесной светильник на диммируемых LED последнего поколения. Доступные отделки: глянцевый белый и коричневый металллик, опаловый диффузор из полиметилметакрилата (PMMA).

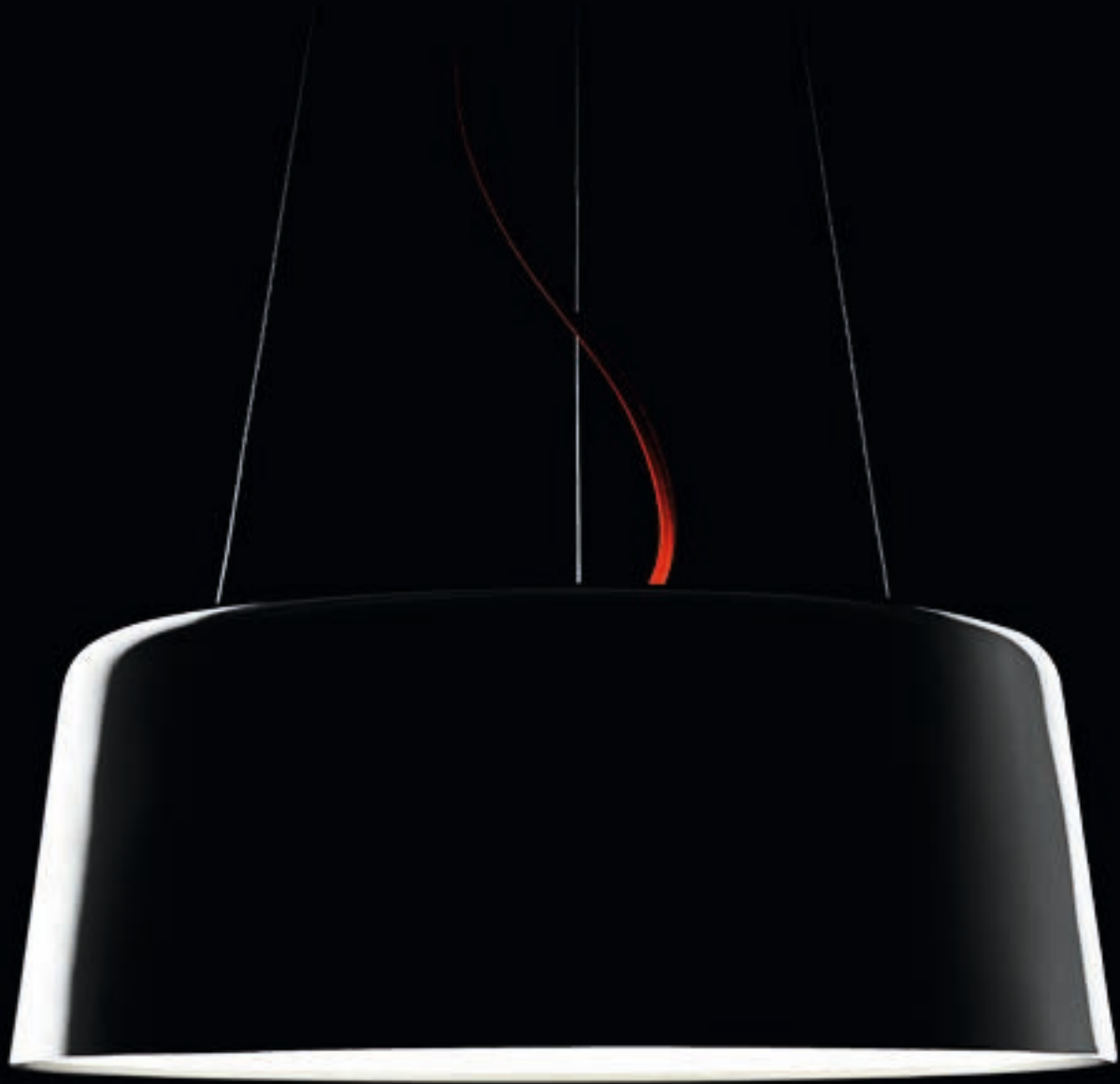

Blanca_

Ø 90







Blanca_
Ø 60



Blanca_
Ø 90



Enoteca Caffè Vistarini - Lodi, Italia



Blanca_
Ø 60





BLANCA60



BLANCA90

Blanca_

design_Federico Churba 2012

IP40

Energy Label available at www.panzeri.it

220 / 240 V

LED

	CODICE / CODE	CM Ø H	INCHES Ø H
Sospensione / Suspension	L 57_ _ DIM	60 23	Ø 23 5/8" 9"
	L 57_ _ 90 DIM	89 28	Ø 35" 11"

63W 3000K Ra 80 6900lm dimmable driver



69W 3000K Ra 80 7500lm dimmable driver



Fotometrie disponibili www.panzeri.it / Photometric data available at www.panzeri.it

CODICI COLORI DISPONIBILI / COLOURS CODES AVAILABLE

1 0 Bianco lucido
Glossy white

4 4 Marrone metallizzato
Metallized brown



Carmen_Carmencita_

Design_Carmen Ferrara
2013/2014



Lampade da soffitto a LED in metallo bianco o nero con bracci snodati. Disponibile anche la versione a parete.

LED-Deckenleuchten aus weißem oder schwarzem Metall mit Gelenkarmen. Auch Wandleuchten Ausführung.

Plafonniers à LED en métal blanc ou noir à bras articulés. Disponible aussi en version appliqués.

LED ceiling lamps in black or white metal with articulated arms. Wall lamp version also available.

Lámparas de plafón LED de metal blanco o negro con brazos articulados. Disponible también la versión de pared

Потолочные светодиодные светильники из металла белого или черного цвета с поворотными планками. Возможен настенный вариант.



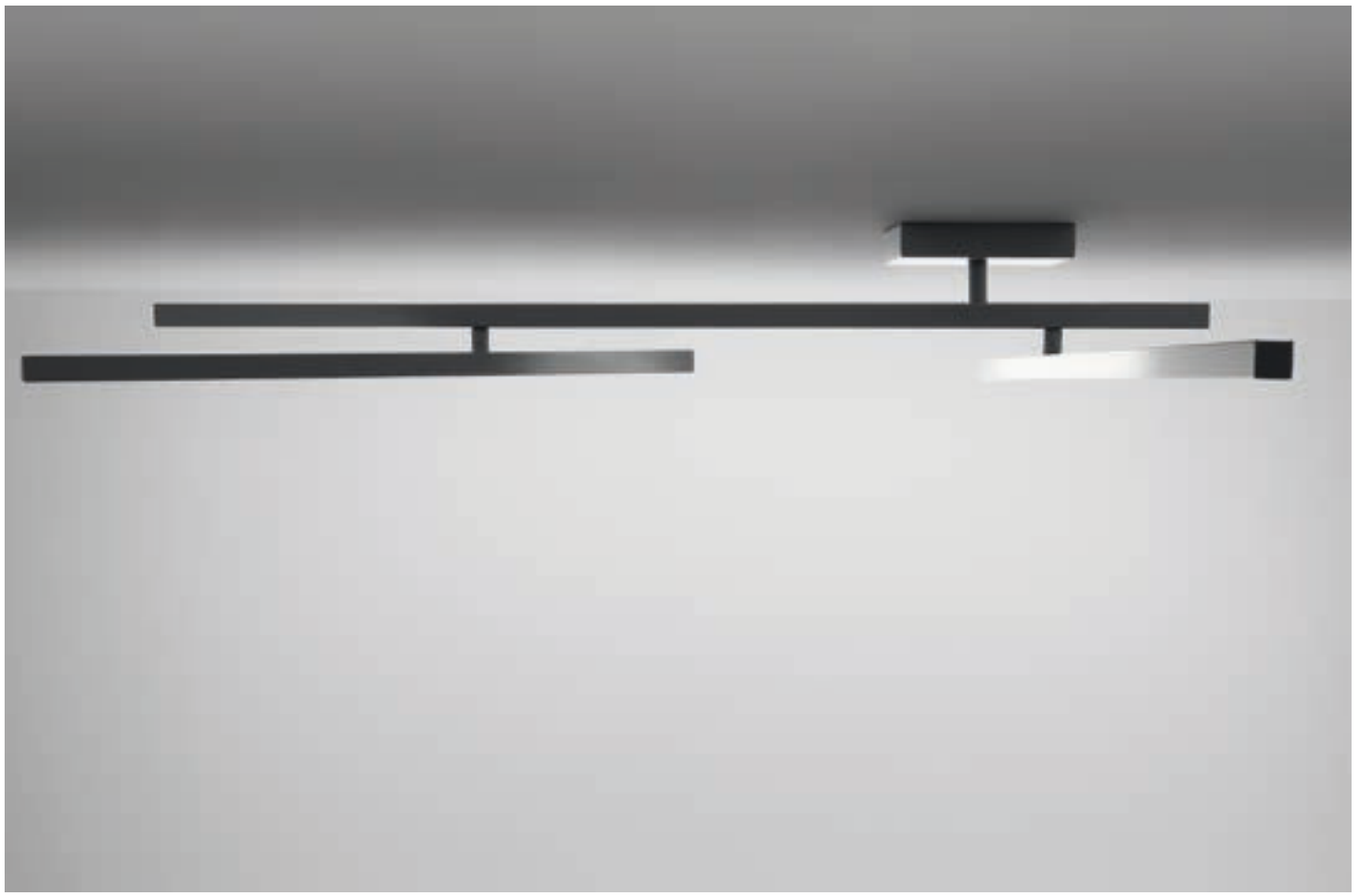

Carmen_



Uffici TP - Ragusa, Italia



Carmen_





Carmencita_



Carmen_



Private house - Monza, Italia

Carmen_Carmencita

design_Carmen Ferrara 2013/2014

LED CE IP20

Energy Label available at www.panzeri.it

220 / 240 V

	CODICE / CODE	CM A x B	H	INCHES A x B	H	LED
Soffitto / Ceiling	P 64_ _	222	20	87 1/2"	7 7/8"	49W 3000K Ra 80 6180lm L10V PUSH DIM
	P 64_ _-2	151	20	59 1/2"	7 7/8"	26W 3000K Ra 80 3225lm
Parete / Wall	A 64_ _	26 x 14	61	10 1/4" x 5 1/2"	24"	11W 3000K Ra 80 1340lm

Fotometrie disponibili www.panzeri.it / Photometric data available at www.panzeri.it

CODICI COLORI DISPONIBILI / COLOURS CODES AVAILABLE

01 Bianco
White

02 Nero
Black

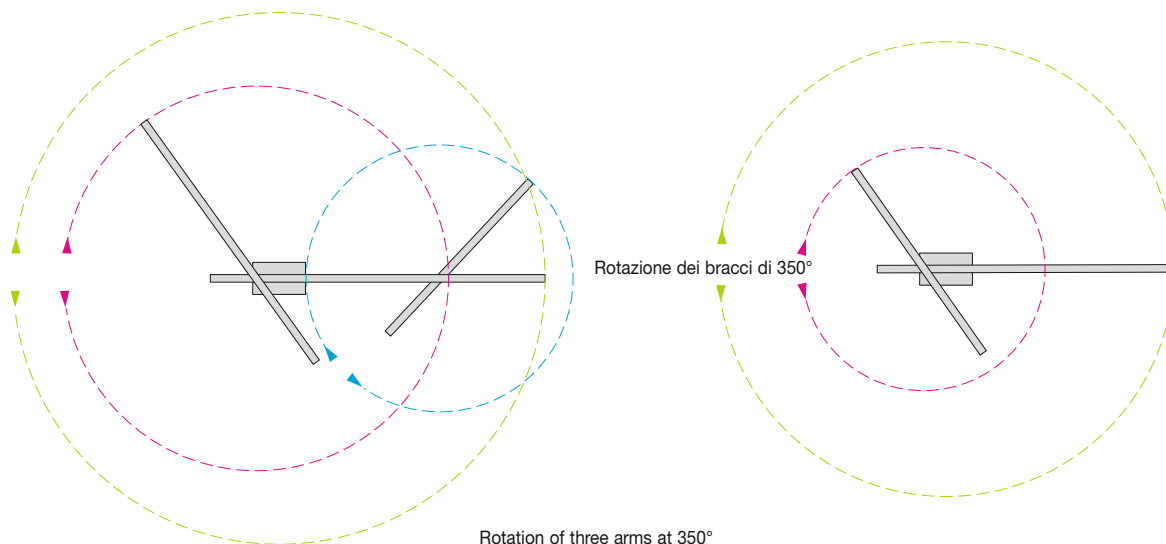

Rotazione dei bracci di 350°

Rotation of three arms at 350°
Die Drei arm 350° schwenkbar
Rotación de los tres brazos de 350°
Rotation des trois bras à 350°
Угол вращения трех рожков 350°.

App_

Design_Q2 2013



Lampada da parete a LED in alluminio lucido, alluminio verniciato bianco o titanio.

LED wall lamp in polished aluminium, white or titanium aluminium.

LED Wandleuchten aus Glänzendem Aluminium, Weißen oder titanium Aluminium.

Lámpara de pared LED en aluminio brillante, blanco o titanio.

Applique LED en aluminium brillant, blanc ou titanium.

Настенный светильник на LED из полированного либо окрашенного в белый, titanium цвет алюминия.



App_







App_

App_

design_Q² 2013

LED CE IP20 

Energy Label available at www.panzeri.it

220 / 240 V

	CODICE / CODE	CM A x B	H	INCHES A x B	H	LED
Parete / Wall	APP 1.0. _ _	12 x 20	20	4 ¾" x 7 ¾"	7 ¾"	17,5W 3000K Ra 80 1590lm
	APP 2.0. _ _	24 x 20	20	9 ½" x 7 ¾"	7 ¾"	35W 3000K Ra 80 3180lm

Fotometrie disponibili www.panzeri.it / Photometric data available at www.panzeri.it

CODICI COLORI DISPONIBILI / COLOURS CODES AVAILABLE

01 Bianco
White

30 Titanio
Titanium

36 Alluminio lucido
Polished aluminium



Ralph_

Design_Team Design 2011



RALPH Ø 50

RALPH Ø 90

Collezione di lampade IP65 in alluminio e ottone verniciate marrone o bianco con paralume in rattan sintetico.

Lamps collection IP65 in aluminium and brass metallized brown or white painted. Rattan synthetic lampshade.

Leuchtenkollektion IP65 aus Aluminium und Messing weiß- oder braunmetallisch. Synthetischer Rattan Lampenschirm.

Colección de lámpara IP65 en aluminio e latón marrón o blanco metalizado. Pantalla en rattan sintético.

Collection de lampes IP65 en aluminium et laiton peinté brun ou blanc métallisé. Abat-jour en rattan synthétique.

Коллекция светильников со степенью защиты IP65 из алюминия и латуни, коричневый металлик или крашенный белый. Абажур из синтетического ротанга.





Ralph_
Ø 90





RALPH Ø 35

RALPH Ø 50

Ralph_
Ø 50





Ralph_
Ø 50

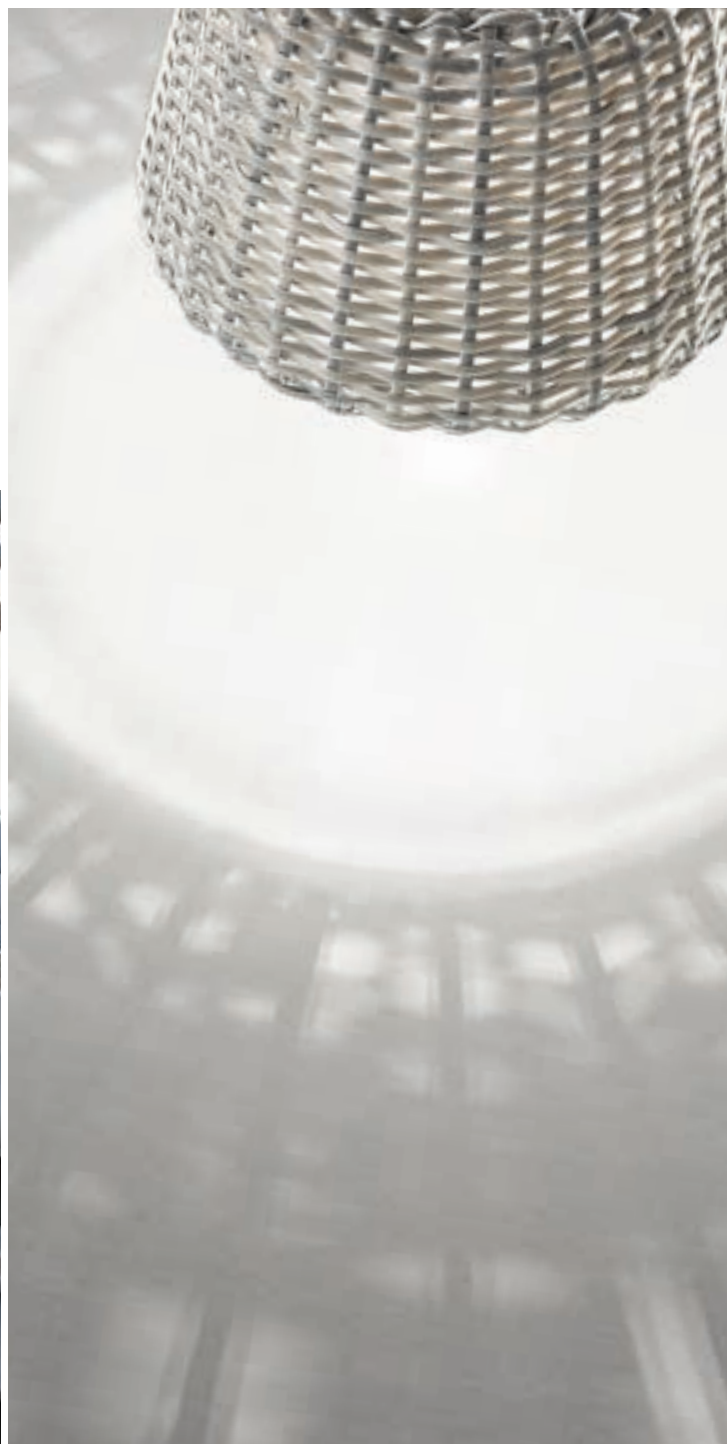



Lampada da esterno-interno in rattan sintetico con diffusore in polimetilmetacrilato (PMMA) trasparente con cavo arancio.

Interior/outside lamps in synthetic rattan lampshade with clear polymethylmethacrylate (PMMA) diffuser and orange cable.

Innen und Außenbereichleuchte mit syntethischem Rattan Lampenschirm und mit klarem Schirm in Polymethylmethacrylat (PMMA). Oranges Kabel.

Lámpara de interno/externo con pantalla en rattan sintético con difusor en polimetilmetacrilato (PMMA) transparente con cable naranja.

Lampe pour intérieur/extérieur avec abat-jour en rattan synthétique, diffuseur en polyméthacrylate de méthyle (PMMA) transparent et orange câble.

Светильник для внутреннего и наружного освещения из синтетического ротанга с рассеивателем из прозрачного полиметилметакрилата (пмма) и проводом оранжевого цвета.

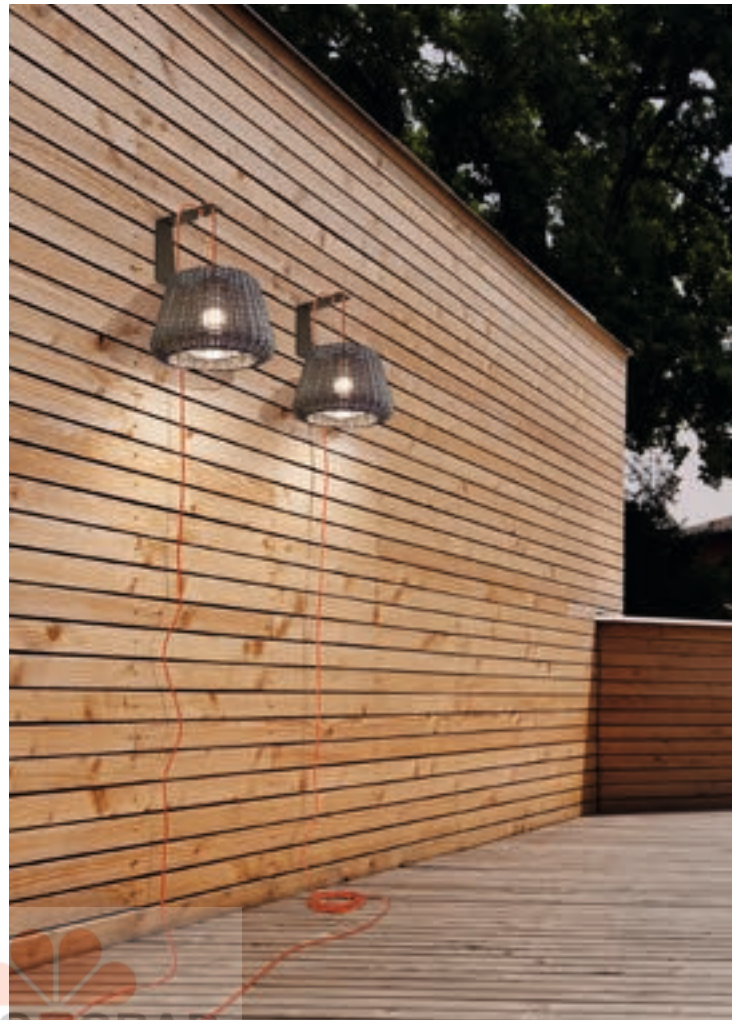

Ralph_ Ø 50

Sospensioni IP65, cavo arancio 4,50 mt con spina. In dotazione rosone, O-Ring silicone e gancio per molteplici appendimenti. A richiesta accessorio in alluminio plastificato per appendimento a parete per EL 47_ _35.

Suspensions IP65, 4,50 mt orange cable with plug. Canopy, silicone O-ring and hook to be use for multiple fixing included. Bracket in plasticized aluminium to fix as a wall lamp for EL 47_ _35 on request.

Hängeleuchten IP65, Mt 4,50 oranges Kabel mit Steckdose. Inklusiv Rosette, silikon O-Ring und Haken für verschiedene Fixierungsmöglichkeiten. Zubehör aus plastifiziertem Aluminium zur Wandausführung für EL 47_ _35 auf Anfrage.

Suspensions IP65, 4,50 mt de cable naranja con enchufe. Roseton, silicona O-Ring y gancho para diferentes modo de colgar incluido. Abrazadera de aluminio plastificada por le fijacion a pared por EL 47_ _35 a petición.

Suspensions IP65, 4,50 mt de câble orange avec l'épîne. Rosace, desilicone O-Ring et mousqueton pour differentes façon de fixage. Étrier en aluminium plastifié pour le fixage comme applique pour EL 47_ _35 sur demande.

Подвесной светильник с IP65, провод оранжевого цвета 4,50м с вилкой. В комплект, silicone O-Ring входят розон и крюк для разного типа подвешивания. По спец. Запросу поставляется аксессуар из пластифицированного алюминия для крепления на стену x EL 47_ _35.

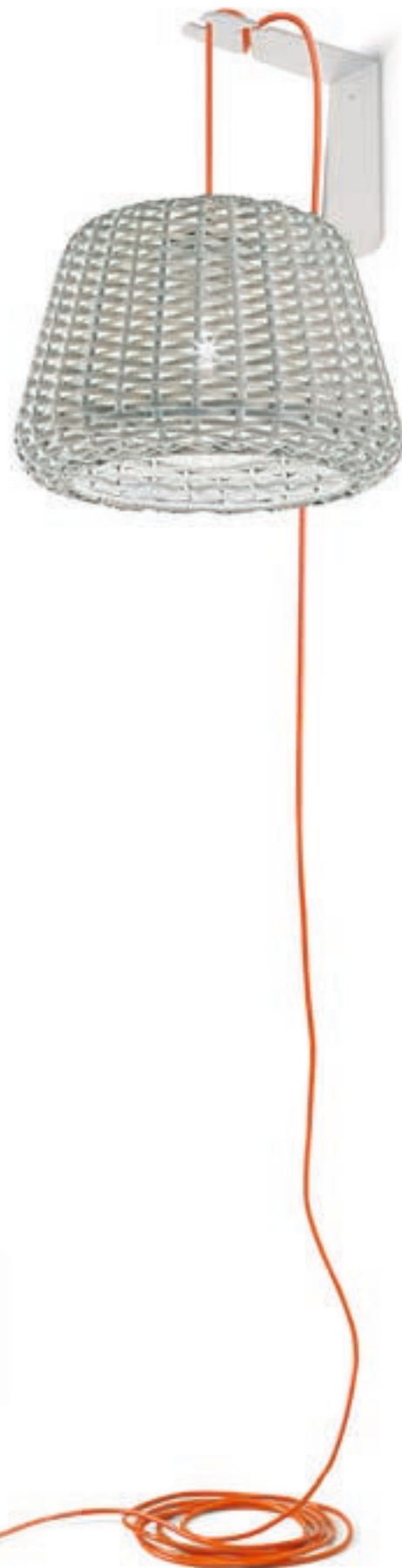



Ralph_

Hard Rock Hotel - Ibiza, Spain







Ralph_



Ralph_

design_Team Design 2011

CE IP65  

Energy Label available at www.panzeri.it

	CODICE / CODE	CM Ø / A x B H	INCHES Ø / A x B H	FLUO	HALO
Sospensione / Suspension	EL 47__35	35 25	13 3/4" 9 7/8"	max 23W Micro Twist E27	max 53W E27
	EL 47__50	50 34	19 3/4" 13 1/4"	max 23W Micro Twist E27	max 53W E27
	EL 47__90	90 61	35 1/2" 24"	max 23W Micro Twist E27	max 53W E27
Tavolo / Table	EC 47__35	35 58	13 3/4" 22 7/8"	max 23W Micro Twist E27	max 53W E27
Terra / Floor	ET 47__35	35 115	13 3/4" 45 1/4"	max 23W Micro Twist E27	max 53W E27
	ET 47__35-P	35 115	13 3/4" 45 1/4"	max 23W Micro Twist E27	max 53W E27
	ET 47__50	55 190	21 1/2" 74 3/4"	max 23W Micro Twist E27	max 53W E27
	M47__ A	20,5 18,3	8" 7 1/4"	Staffa a parete per art. EL 47__35 / Wall bracket for item EL 47__35	
	M47T			Picchetto per fissaggio a terreno art. ET 47__50 Peg to fix to the ground for item ET 47__50	

CODICI COLORI DISPONIBILI / COLOURS CODES AVAILABLE

01 Bianco
White

44 Marrone metallizzato
Metallized brown



LAMPyris_

Design_Lorenzo Giacomini 2014



Lampada da esterno a LED IP65 in alluminio e policarbonato.

LED-Leuchte für den Außenbereich IP65 aus Aluminium und Polycarbonat.

Lampe d'extérieur à LED IP65 en aluminium et polycarbonate.

Outdoor lamp with LED IP65 in aluminium and polycarbonate.

Lámpara para el exterior con LED IP65 en aluminio y policarbonato.

Уличный LED светильник со степенью защиты IP65 из алюминия и стекла.





LAMPyris_





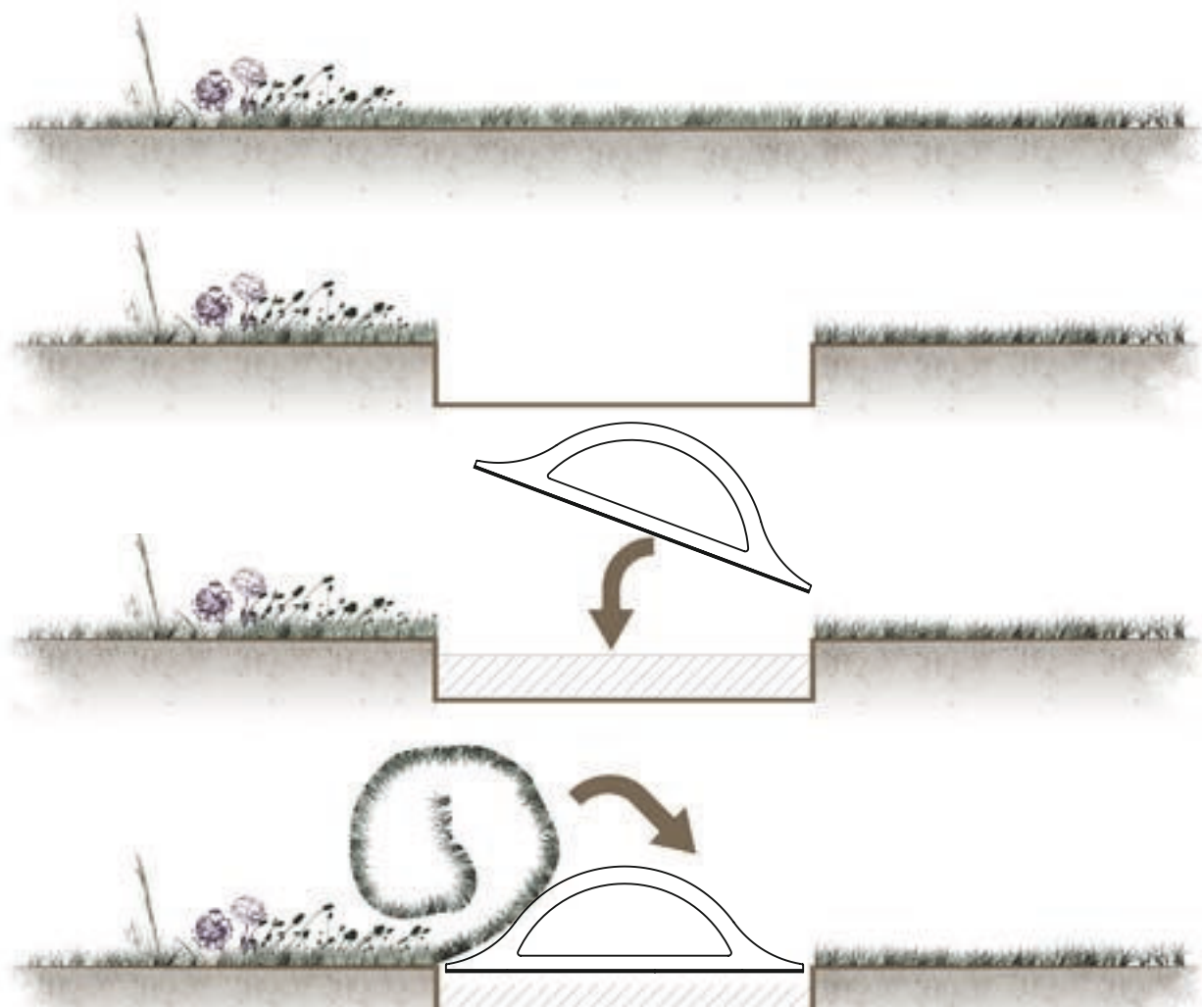

LAMPyris_

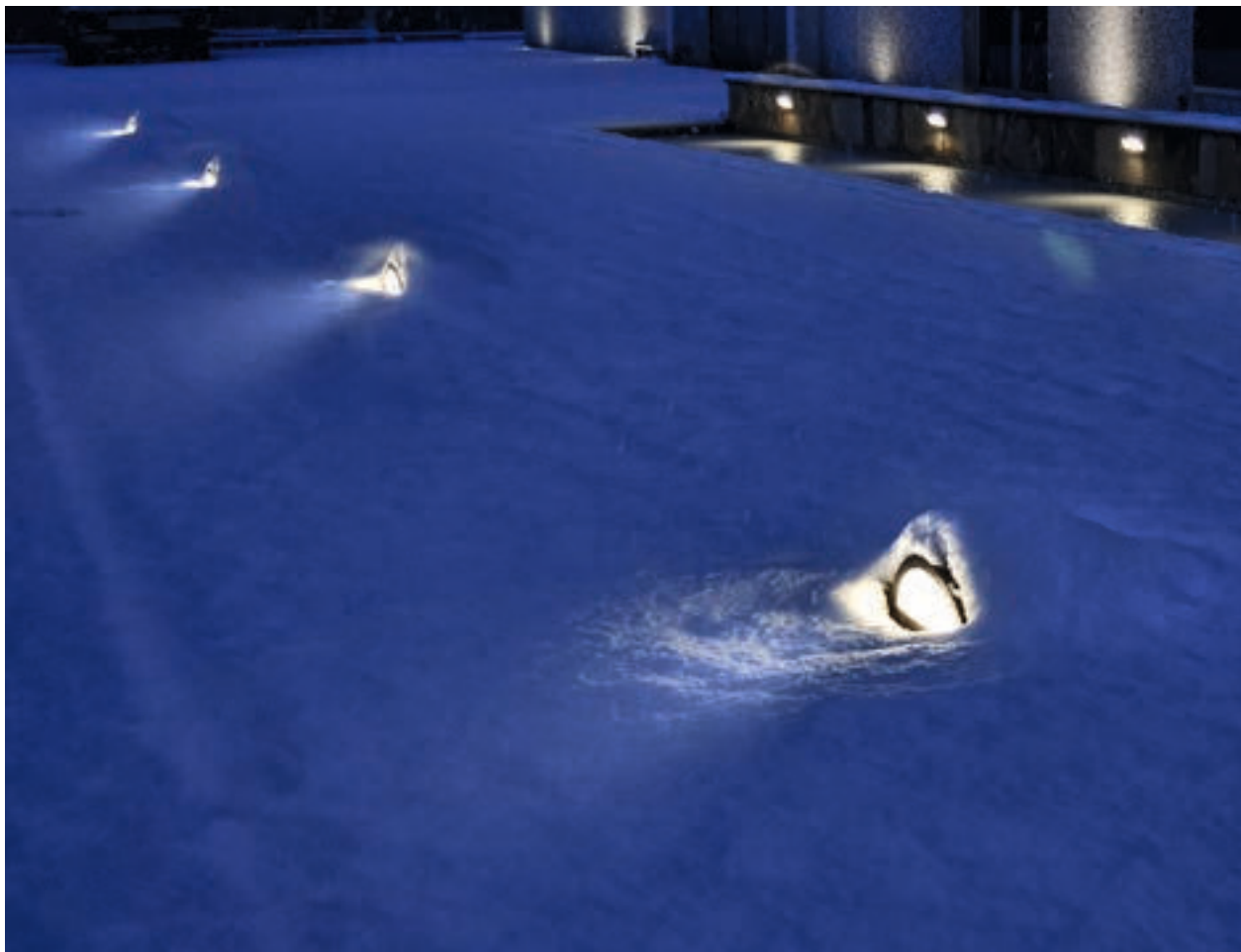

LAMPyris_

design_Lorenzo Giacomini 2014

LED CE IP65 IK09

Energy Label available at www.panzeri.it

220 / 240 V

LED

	CODICE / CODE	CM A x B	H	INCHES A x B	H	
Terra / Floor	ET 8001 BROWN	62 x 38,5	18	24 3/4" x 15 1/8"	7	8W 3000K Ra 80 1000lm

Fotometrie disponibili www.panzeri.it / Photometric data available at www.panzeri.it

Potter_

Design_Valerio Bottin
Enzo Panzeri 2011



Lampada da interno/esterno in polietilene bianco, utilizzabile come seduta.

Illuminated interior/outside stool in white polyethylene.

Hocker aus Polyethylen weiß mit Leuchtkörper für den Innen- und Außenbereich.

Asiento iluminado de interno/externo en polietileno blanco.

Un assis illuminé pour intérieur/extérieur en polyéthylène blanc.

Светильник из белого полиэтилена, применим для внутреннего и наружного освещения, возможно использовать как табурет.

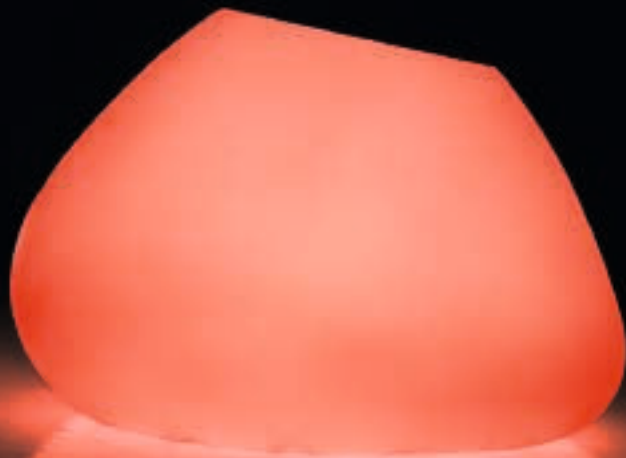





Potter_





Potter_



Potter_

design_Valerio Bottin_Enzo Panzeri 2011

Registered Design



Energy Label available at www.panzeri.it

+ ELECTRIC OPTIONS:

	CODICE / CODE	CM A x B	H	INCHES A x B	H	XM42 IN (indoor)	XM42 OUT (outdoor)	XM42 RGB (outdoor)
Lampada / Lamp Seduta / Stool	EC 4201	80 x 70	55	31 1/2" x 27 1/2"	21 5/8"	max 70W E27 max 30W Superstar E27 + interruttore / Switch IP20	max 70W E27 max 30W Superstar E27 IP65	RGB max 8,2W 350mA 220-240V + remote control IP65
	M42	picchetto per fissare la lampada al terreno / Peg to fix lamp to the ground						

Portata max 130 Kg / Maximum load 130 Kg

CODICI COLORI DISPONIBILI / COLOURS CODES AVAILABLE

01 Bianco
White



Agave_

Design_Diego Chilò 2009



Sospensioni, plafoniere, lampada da parete con petali di metallo verniciati in bianco. A richiesta foglia oro, foglia argento o foglia rame. Diffusori in vetro satinato.

Suspensions, ceiling, wall lamps with pieces of white painted metal. On request gold, silver or copper leaf. Mat glass.

Hänge-, Decken-, Wandleuchte mit Metallelementen, weiß lackiert. Auf Anfrage Blattgold, Blattsilber oder BlattKupfer. Lichtverteiler aus Mattglas.

Suspensiones, lámparas de techo, de pared con piezas de metal lacado blanco. A petición pan de oro, pan de plata o pan de cobre. Cristal satinado.

Suspensions, plafonniers, applique avec pétales en métal vernies en blanc. Sur demande feuille d'or, feuille d'argent ou feuille de cuivre. Diffuseurs en verre satiné.

Подвесные, потолочные, настенные светильники из металлических лепестков окрашенных в белый цвет либо покрытых сусальным золотом или серебром. Сусальная медь доступна по запросу. Рассеиватель из матового стекла.



Agave_



AGAVE Ø51



AGAVE Ø71



AGAVE Ø89



Agave_



Agave_ design_Diego Chilà 2009 Registered Design **CE** IP20

Energy Label available at www.panzeri.it

	CODICE / CODE	CM Ø / A x B H	INCHES Ø / A x B H	FLUO	HALO
Sospensione / Suspension	L 30_._50	51 77	20" 30 ¼"	max 30W Superstar E27	max 205W E27 + 75W Halopar 20 GU10
	L 30_._70	71 84	28" 33"	4x max 30W Superstar E27	4x max 150W E27 GU10 + 75W Halopar 20 GU10
	L 30_._90	89 117	35" 46"	6x max 30W Superstar E27	6x max 150W E27 GU10 + 75W Halopar 20 GU10
Soffitto / Ceiling	P 30_._50	51 32	20" 12 ½"	max 23W Micro Twist E27	max 205W E27
	P 30_._70	71 42	28" 16 ½"	3x max 30W Superstar E27	3x max 150W E27
	P 30_._90	89 52	35" 20 ½"	3x max 30W Superstar E27	3x max 150W E27
Parete / Wall	A 30_._	45 x 20 30	17 ¾" x 7 ¾" 11 ¾"	2x max 23W Micro Twist E27	2x max 150W E27

CODICI COLORI DISPONIBILI / COLOURS CODES AVAILABLE

- 0 1** Bianco
White
- 2 1** Foglia oro (a richiesta)
Gold leaf (available on request)
- 2 3** Foglia argento (a richiesta)
Silver leaf (available on request)
- 2 4** Foglia rame (a richiesta)
Copper leaf (available on request)





Tutu_

Design_Hiroki Takada 2012

Sospensioni, plafoniere e lampada da parete con diffusore in pyrex. Elementi decorativi in carta sintetica giapponese, appesi con particolari in tecnopolimero rosso. Montature in fusione di alluminio di colore bianco.

Suspensions, ceiling lamps and wall lamp with pyrex as diffuser. Decorative elements in Japanese synthetic paper, hung by red polymer details. Fittings in white aluminium.

Wand-, Hänge und Deckenleuchten mit Pirex-Schirm. Dekorationselemente aus synthetischem, japanischem Papier, aufgehängt mit roten Polymerelementen. Struktur aus weißem Aluminium.

Suspensiones, lámparas de plafón y de pared con difusor en pyrex. Elementos decorativos en papel sintético japonés adornado con detalles en polímero rojo. Monturas en aluminio blanco.

Suspensions, plafonniers et applique avec diffuseur en pyrex. Parties décoratives de papier synthétique japonais accroché avec des détails en polymère rouge. Montures en aluminium blanc.

Подвесные, потолочные светильники и бра с рассеивателем из Pyrex. Декоративные элементы из японской синтетической бумаги, подвешены с деталями из технополимера. Арматура из литого алюминия белого цвета.



Tutu_





Tutu_







Tutu_

Tutu_		design_Hiroki Takada 2012				Registered Design CE IP20	
Energy Label available at www.panzeri.it							
220 / 240 V							
	CODICE / CODE	CM Ø / A x B	H	INCHES Ø / A x B		H	FLUO
Sospensione / Suspension	L 5601.55	55	39	21 ½"	15 ¼"		26/32/42W GX24 q-3/q-4
	L 5601.70	70	40	27 ½"	15 ¾"		2x 26/32/42W GX24 q-3/q-4
Soffitto / Ceiling	P 5601.55	55	39	21 ½"	15 ¼"		26/32/42W GX24 q-3/q-4
	P 5601.70	70	40	27 ½"	15 ¾"		2x 26/32/42W GX24 q-3/q-4
Parete / Wall	A 5601	55 x 35	45	21 ½" x 13 ¾"	17 ¾"		26W G24 q-3

CODICI COLORI DISPONIBILI / COLOURS CODES AVAILABLE

01 Bianco
White



Twister_

Design_Enzo Panzeri 1998



Lampada da terra, da tavolo, da soffitto e da parete in nichel satinato. Vetro soffiato bianco satinato.

Tisch-, Wand-, Hänge- und Stehleuchte in satiniertem Nickel. Mundgeblasene, weiße Mattgläser.

Lampe au sol, lampe de table, de plafond et applique en nickel satiné. Verre soufflé blanc satiné.

Table, floor, suspension and wall lamps in mat nichel metal. Blown white mat glass.

Lámpara de suelo, de mesa, de techo y de pared de níquel satinado. Vidrio soplado blanco satinado.

Настольные, напольные, подвесные и настенные светильники, цвет матовый никель. Матовое выдувное стекло белого цвета.







Twister_





Twister_

Twister_		design_Enzo Panzeri 1998				CE IP20 (☐ Table / Floor) Ⓢ	
Energy Label available at www.panzeri.it							
220 / 240 V							
	CODICE / CODE	CM Ø / A x B	H	INCHES Ø / A x B	H	FLUO	HALO
Sospensione / Suspension	L 6732.35	14	34	5½"	13 ¼"		max 150W B15d
	L 6732.50	20	55	8"	21 ½"	max 23W Micro Twist E27	max 150W E27
Parete / Wall	A 6732.35	24 x 11	32	9 ½" x 4 ¼"	12 ½"	max 23W Micro Twist E27	max 70W E27
	A 6732.50	24 x 11	51	9 ½" x 4 ¼"	20"	2x max 23W Micro Twist E27	2x max 70W E27
Tavolo / Table	C 6732.35	15	51	6"	20"		max 60W E14
	C 6732.50	21	78	8 ¼"	30 ¾"	max 23W Micro Twist E27	max 150W E27
Terra / Floor	T 6732	29	183	11 ½"	72"		max 205W E27 dimmer

CODICI COLORI DISPONIBILI / COLOURS CODES AVAILABLE

32 Nichel_Bianco
Nickel_White



Disco_

Design_Team Design 2006



Lampada da parete e plafoniera in vetro soffiato satinato bianco. Struttura a scomparsa (per i modelli Ø 30 cm e Ø 40 cm) in metallo verniciato bianco. Struttura a vista (per il modello Ø 50 cm) in metallo verniciato bianco. Disponibile anche in versione LED.

Wall and ceiling lamp made of mat blown glass. Invisible white metal part for Ø 30 cm and Ø 40 cm size. Visible white metal part for Ø 50 size. LED version also available.

Wand- oder Deckenleuchte mit weißem satiniertem Glas. Bei Ø 30 cm und Ø 40 cm Halterung nicht sichtbar. Bei Ø 50 cm weiße Halterung sichtbar. Deckenleuchte auch in LED-Ausführung.

Lámpara de pared y plafón de vidrio soplado satinado blanco. Estructura escondida (para los modelos Ø 30 cm y Ø 40 cm) de metal barnizado blanco. Estructura de vista (para el modelo Ø 50 cm) de metal barnizado blanco. Disponible también en versión LED.

Applique et plafonnier en verre soufflé satiné blanc. Structure cachée (pour les modèles Ø 30 cm et Ø 40 cm) en métal verni blanc. Structure en vue (pour le modèle Ø 50 cm) en métal verni blanc. Disponible aussi en version LED.

Настенные и потолочные светильники из белого матового выдувного стекла. Белое металлическое основание. Невидимое для моделей Ø 30см и Ø 40см, видимое для модели Ø 50см. LED версия также доступна.

Disco_		design_Team Design 2006		LED CE IP20		Energy Label available at www.panzeri.it	
				220 / 240 V			
	CODICE / CODE	CM Ø H	INCHES Ø H	FLUO	HALO	LED	
Soffitto / Ceiling	P 6601.30 LED	30 9	11 ¾" 3 ½"			12W 3000K Ra80 1460lm	
	P 6601.30	30 9	11 ¾" 3 ½"	max 14W Micro Twist E27	max 53W E27		
	P 6601.40 LED	40 10	15 ¾" 4"			18W 3000K Ra80 2190lm	
	P 6601.40	40 10	15 ¾" 4"	2x max 18W Micro Twist E27	2x max 53W E27		
	P 6601.50 LED	50 16	19 ¾" 6 ¼"			18W 3000K Ra80 2190lm	
	P 6601.50	50 16	19 ¾" 6 ¼"	2x max 23W Micro Twist E27	2x max 53W E27		

Fotometrie disponibili www.panzeri.it / Photometric data available at www.panzeri.it

CODICI COLORI DISPONIBILI / COLOURS CODES AVAILABLE

01 Bianco
White





Jazz_

Design_Silvia Poma 2004



Sospensioni verniciate bianco o grigio metallizzato con doppio vetro in borosilicato parzialmente satinato. Disponibile anche in versione LED.

Suspension white painted finish or metallized grey metal and double borosilicate glass shades with a partial satin finish. LED version also available.

Hängeleuchten weiß lackiert oder graumetallic mit teilweise satiniertem, doppeltem Borosilikatglas. Auch in LED- Ausführung.

Suspensión blanco o gris metalizado. Doble vidrio borosilicado parcialmente satinado. Disponible también en versión LED.

Suspension en blanc ou gris métallisé. Double verre borosilicate en partie satiné. Disponible aussi en version LED.

Подвесной светильник. Цвет арматуры: белый или серый металл. Плафоны из двойного частично сатинированного боросиликатного стекла. LED версия также доступна.







Jazz_

design_Silvia Poma 2004



Energy Label available at www.panzeri.it

220 / 240 V

	CODICE / CODE	CM Ø / A x B	H	INCHES Ø / A x B	H	HALO	LED	
Sospensione / suspension	L 89_ _ LED	6,5	35	2 ½"	13 ¾"		3,2 W 3000K Ra80 320lm	
	L 89_ _	6,5	35	Ø 2 ½"	13 ¾"	max 48W G9		
Sospensione senza rosone per composizioni multiple Suspension without canopy for multiple compositions	M 89_ _ - S LED	6,5	35	2 ½"	13 ¾"		3,2 W 3000K Ra80 320lm 24V	
	M 89_ _ - 42 LED	max 3 M89_ _-S LED*	42 x 6,5	16 ½" x 2 ½"				
	M 89_ _ - 76 LED	max 5 M89_ _-S LED*	76 x 6,5	30" x 2 ½"				
	M 89_ _ - 25 LED	max 6 M89_ _-S LED*	42 x 25	16 ½" x 9 ⅞"				
	M 8901- S		6,5	35	2 ½"	13 ¾"	max 48W G9	
	M 89_ _ - 42	max 3 M89_ _-S	42 x 6,5	16 ½" x 2 ½"				
	M 89_ _ - 76	max 5 M89_ _-S	76 x 6,5	30" x 2 ½"				
	M 89_ _ - 25	max 6 M89_ _-S	42 x 25	16 ½" x 9 ⅞"				

Fotometrie disponibili www.panzeri.it / Photometric data available at www.panzeri.it

* incluso 24V dc driver
24V dc driver included

CODICI COLORI DISPONIBILI / COLOURS CODES AVAILABLE

01 Bianco
White

33 Grigio metallizzato
Metallized grey



Blow_

Design_Enzo Panzeri 2003
Mario Ornaghi



Lampada da terra, da tavolo, a soffitto, da parete e sospensione in nichel satinato. Vetro soffiato bianco satinato.

Tisch-, Wand-, Decken-, Stehleuchte und Hängeleuchte in Nickel. Mundgeblasenes Glas weiß satiniert.

Lampe au sol, lampe de table, applique, plafonniers et suspension en nickel. Verre soufflé blanc satiné.

Table, floor, ceiling and wall lamps and suspensions in mat nickel metal. Blown white mat glass.

Lámpara de suelo, de mesa, de pared, plafones y suspensiones níquel. Vidrio soplado blanco satinado.

Торшер, настольные лампы, бра, потолочный и подвесные светильники. Цвет сатинированный никель. Выдувное белое сатинированное стекло.





Blow_





Blow_

Blow_		design_Enzo Panzeri - Mario Ornaghi 2003				CE IP20 (☐ Table / Floor) Ⓢ	
Energy Label available at www.panzeri.it							
220 / 240 V							
	CODICE / CODE	CM Ø / A x B	H	INCHES Ø / A x B	H	FLUO	HALO
Sospensione / Suspension	L 7932.20	23	13	9"	5 1/8"		max 60W E14
	L 7932.40	39	18	15 1/4"	7"	max 18W Micro Twist E27	max 150W E27
Soffitto / Ceiling	P 7932	39 x 18	18	15 1/4" x 7"	7"	2x max 23W Micro Twist E27	2x max 53W E27
Parete / Wall	A 7932	23 x 15	23	9" x 6"	9"		max 100W E27
Tavolo / Table	C 7932.20	23	23	9"	9"		max 60W E14
	C 7932.40	39	33	15 1/4"	13"	max 18W Micro Twist E27	max 150W E27
Terra / Floor	T 7932	39	185	15 1/4"	72 3/4"		max 205W E27 dimmer

CODICI COLORI DISPONIBILI / COLOURS CODES AVAILABLE

32 Nichel
Nickel



Blow mini_

Design_Enzo Panzeri 2003



Lampada da tavolo, da parete, da soffitto e sospensione in nichel satinato. Vetro soffiato bianco.

Tisch-, Wand-, Decken- und Hängeleuchte aus satiniertem Nickel. Mundgeblasenes Glas weiß.

Lampe de table, applique, lampe de plafond et suspension, en nickel satiné. Verre soufflé blanc.

Table, wall, ceiling and suspensions in mat nickel metal. Blown white mat glass.

Lámpara, de mesa, de pared, de techo y de suspensión, de níquel satinado. Vidrio soplado blanco.

Настольные, настенные, потолочные и подвесные светильники, цвет матовый никель. Матовое выдувное стекло белого цвета.





Blow mini_





Blow mini_

design_Enzo Panzeri 2003

CE IP20 (□ Table) Ⓢ

Energy Label available at www.panzeri.it

	CODICE / CODE	CM Ø	H	INCHES Ø	H	HALO
Sospensione / Suspension	L 8632	14	9	5 ½"	3 ½"	max 48W G9
Parete / Wall	A 8632	14	9	5 ½"	3 ½"	max 48W G9
Tavolo / Table	C 8632	14	9	5 ½"	3 ½"	max 48W G9

CODICI COLORI DISPONIBILI / COLOURS CODES AVAILABLE

32 Nichel
Nickel



Elle_

Design_Highlight 2012



Lampade da parete/plafone in metallo bianco.

Wand/Deckenleuchten in weißem Metall.

Appliques/plafonniers en métal blanc.

Wall/ceiling lamps in white metal.

Lámparas de pared/techo en metal blanco.

бра/потолочные светильники из металла белого цвета.



Elle_





Elle_		design_Highlight 2012				CE IP20	
Energy Label available at www.panzeri.it							
	CODICE / CODE	CM A x B	H	INCHES A x B	H	HALO	
Soffitto / Ceiling	P 5001-1L	16,5 x 16,5	16,5	6 1/2" x 6 1/2"	6 1/2"	max 75W G53 12V QR111	
	P 5001-2L	33 x 16,5	16,5	13" x 6 1/2"	6 1/2"	2x max 75W G53 12V QR111	
	P 5001-1U	16,5 x 16,5	16,5	6 1/2" x 6 1/2"	6 1/2"	max 75W G53 12V QR111	
	P 5001-2U	33 x 16,5	16,5	13" x 6 1/2"	6 1/2"	2x max 75W G53 12V QR111	

+ ELECTRIC OPTIONS:

XM3L GU10 lampholder
 XM5/111 15W G53 3000K 40° Ra80 12VAC/DC 860lm NOT DIMMABLE
 XM50/12 transformer (XM5/111 LED) 1-50W 12VAC
 XM10512 transformer 35-105W 12VAC



Predisposto con foratura multipla per alloggiare qualsiasi tipo di alimentatore da ordinare separatamente
 Prepared with multiple drilling to house any type of power supply to be ordered separately

Fotometrie disponibili www.panzeri.it / Photometric data available at www.panzeri.it

CODICI COLORI DISPONIBILI / COLOURS CODES AVAILABLE

01 Bianco
 White



Draco_

Design_Highlight 2012



Lampada da parete IP54 con LED in alluminio verniciato bianco, grigio metallizzato o marrone metallizzato. Ottica variabile.

LED IP54 wall lamp in white, metallized grey or metallized brown aluminium. Variable optical.

LED Wandleuchten IP54 in weißem, graumetallic oder braunmetallic aluminium. Variable Optical.

Lámparas de pared IP54 con LED en aluminio blanco, gris o marrón metalizado. Óptico variable.

Appliques IP54 a LED en aluminium blanc, gris ou brun métallisé. Optique variable.

Бра IP54 с LED из алюминия, цвет коричневый металлик или белый. Регулируемая оптика.





Draco_

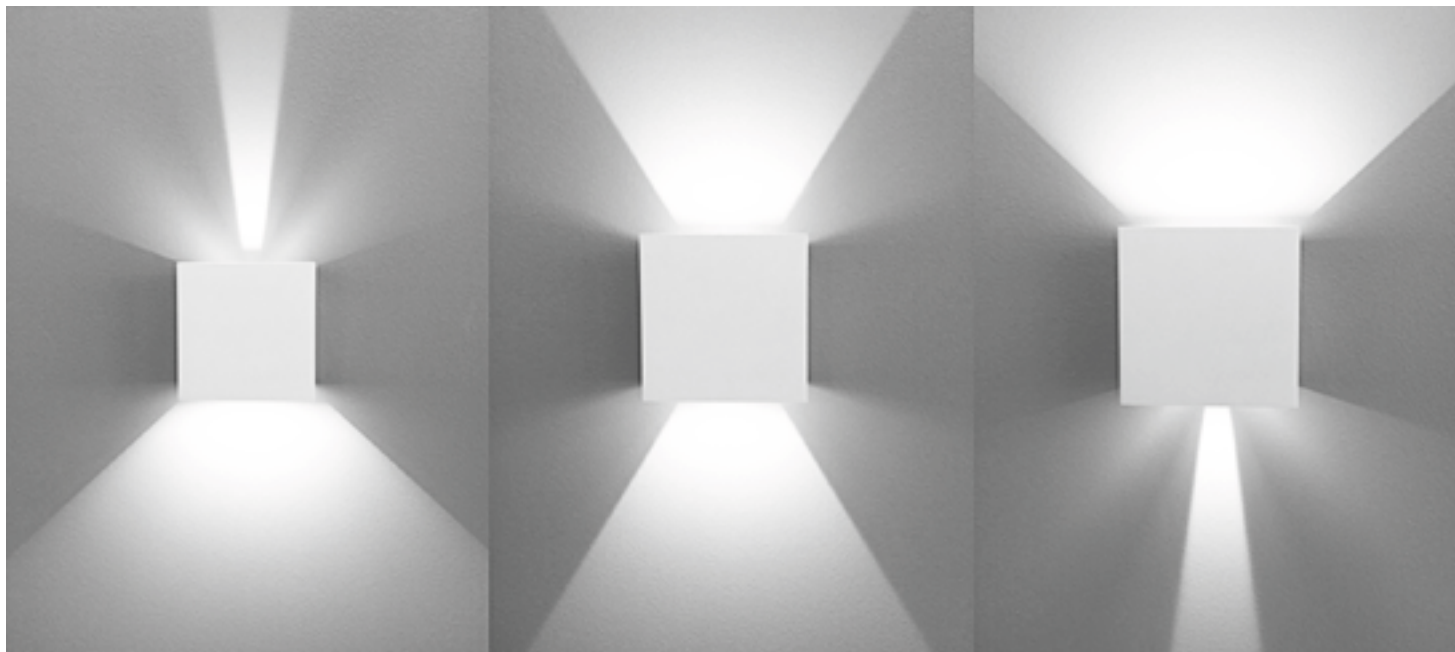

Draco_

design_Highlight 2012

 **CE** IP54

Energy Label available at www.panzeri.it

220 / 240 V

	CODICE / CODE	CM A x B	H	INCHES A x B	H	LED
Parete / Wall	EA 54_ _	10 x 10	10	4" x 4"	4"	6W 3000K Ra 80 305lm + 305lm

Fotometrie disponibili www.panzeri.it / Photometric data available at www.panzeri.it

CODICI COLORI DISPONIBILI / COLOURS CODES AVAILABLE

01 Bianco
White

33 Grigio metallizzato
Metallized grey

44 Marrone metallizzato
Metallized brown



Line_

Design_Team Design 2010



Lampada da terra e sospensione in metallo conificato bianco, nero, marrone, cromo, foglia oro. A richiesta foglia argento o foglia rame. Sospensione disponibile anche in rame lucido.

Floor and suspension lamp in tapered metal white, black, metallized brown, chrome, gold leaf. On request silver or copper leaf. Available suspension also in polished copper.

Steh- und Hängeleuchte in konisch zulaufendem Metall weiß, schwarz, braunmetallisch, chrom, Blattgold. Auf Anfrage Blattsilber oder Blattkupfer. Hängeleuchte auch in Kupfer glänzend Ausführung.

Lámpara de suelo y suspensión en metal afilado blanco, negro, marrón metalizado, cromo, pan de oro. A petición pan de plata o pan de cobre. Suspensión disponible también en cobre lúcido.

Lampe au sol et suspension en métal conique blanc, noir, brun métallisé, chrome, feuille d'or. Sur demande feuille d'argent ou feuille de cuivre. Suspension disponible aussi en cuivre brillant.

Напольные и подвесные светильники конической формы. Доступные отделки: белый, черный, коричневый металл, хром, сусальное золото. Сусальное серебро и сусальная медь доступны по запросу. Подвесные светильники доступны в отделке медь.



Line_







Line_

Line_	design_Team Design 2010						LED CE IP20 
Energy Label available at www.panzeri.it							
220 / 240 V							
	CODICE / CODE	CM Ø	H	INCHES Ø	H	LED	HALO
Sospensione / Suspension	* L 36_ _	8	68	3 1/8"	26 3/4"	INCL. SPOT 9W GU10 3000K 40° not dimmable 700lm	
Terra / Floor	T 36_ _	28	185	11"	72 3/4"	max 205W B15d dimmer	

CODICI COLORI DISPONIBILI / COLOURS CODES AVAILABLE

01 Bianco White	02 Nero Black	21 Foglia oro Gold leaf	22 Cromo Chrome	23 Foglia argento (a richiesta) Silver leaf (available on request)	* 25 Rame lucido Polished copper	44 Marrone metallizzato Metallized brown
---------------------------	-------------------------	-----------------------------------	---------------------------	--	--	--



Tip_

Design_Enzo Panzeri 2012



Lampada da parete in metallo bianco, cromo e rame lucido. A richiesta foglia oro o foglia argento. Disponibile in versione alogena o LED.

Wall lamp in white, chrome and polished copper. On request gold or silver leaf. Available in halogen or LED versions.

Wandleuchte aus weißem metall chrom und Kupfer glänzend. Auf Anfrage Blattgold oder Blattsilber. Als Halogen- oder LED-Leuchte verfügbar.

Lámpara de pared de metal blanco, cromo y cobre lúcido. A petición pan de oro o pan de plata. Disponible en versión halógena o LED.

Applique en métal blanc, chrome et cuivre brillant. Sur demande feuille d'or et feuille d'argent. Disponible en version halogène ou LED.

Настенный светильник из металла. Отделки: белый, хром и медь. Сусальное золото и сусальное серебро по запросу. Доступны версии с галогенными лампами и на LED.

Tap_



Tip_

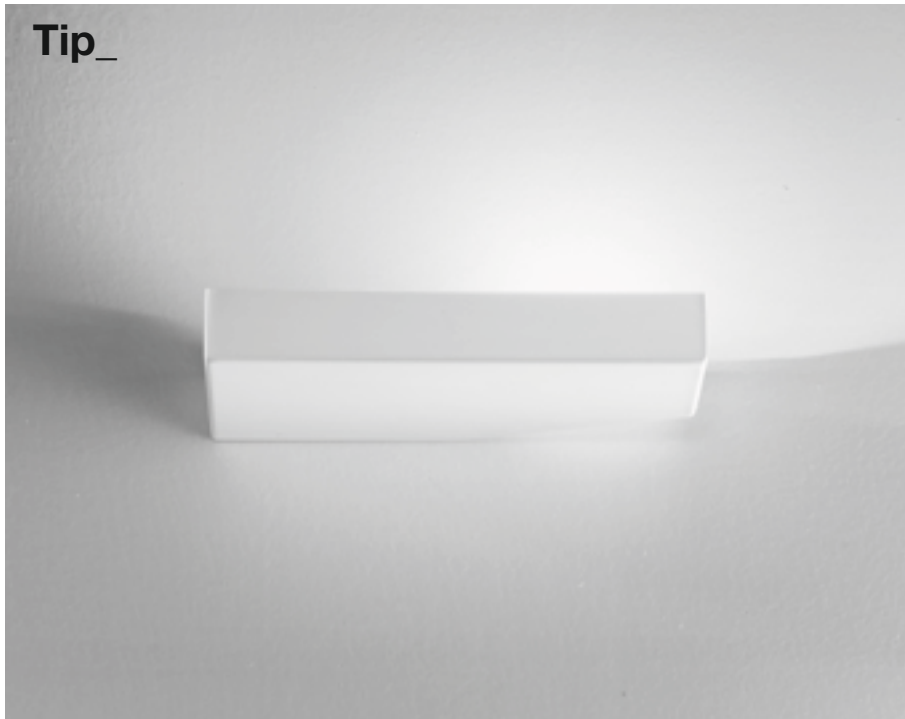

Tap_

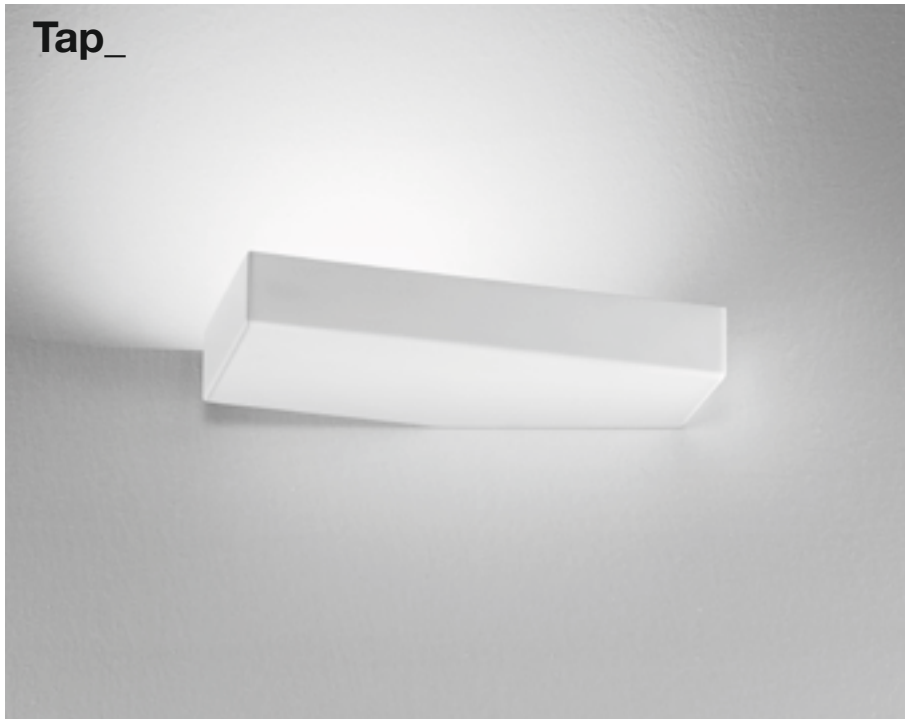

Tip_



Tap_



Tip_



Tip_Tap_

design_Enzo Panzeri 2012

IP20

Energy Label available at www.panzeri.it

220 / 240 V

	CODICE / CODE	CM A x B	H	INCHES A x B	H	LED	HALO
"Tip" Parete / "Tip" Wall	* A 58_ _ LED	21 x 9	3	8 3/4" x 3 3/8"	1 1/8"	13W 3000K Ra 80 1300lm	
	A 58_ _ HALO	21 x 9	3	8 3/4" x 3 3/8"	1 1/8"		max 120W R7s 78mm
"Tap" Parete / "Tap" Wall	* A 59_ _ LED	23 x 11,5	3	9" x 4 1/2"	1 1/8"	13W 3000K Ra 80 1300lm	
	A 59_ _ HALO	23 x 11,5	3	9" x 4 1/2"	1 1/8"		max 120W R7s 78mm

Fotometrie disponibili www.panzeri.it / Photometric data available at www.panzeri.it

CODICI COLORI DISPONIBILI / COLOURS CODES AVAILABLE

01 Bianco White	21 Foglia oro (a richiesta) Gold leaf (available on request)	22 Cromo Chrome	23 Foglia argento (a richiesta) Silver leaf (available on request)	* 25 Rame lucido Polished copper
---------------------------	--	---------------------------	--	--



Tecla_

Design_Friedrich Reiffer 1995



Lampada da parete, da tavolo, da terra e plafoniere in ottone lucido o nichel satinato. Lampada da parete e plafoniere in versione bianca a LED. Vetro opalino bianco.

Wall, table, floor and ceiling lamps in polished brass or mat nickel metal. Wall and ceiling lamps in white LED version. Opaline glass.

Decken-, Wand-, Tisch- und Stehleuchte aus Messing glänzend oder Nickel satiniert. Wand-, Dechenleuchte in Weißen Metall auch in LED- Ausführung. Weißes Opalglas.

Lámpara de pared, de mesa, de suelo y plafón de latón lúcido o níquel satinado. Lámpara de pared y plafón en metal blanco, disponible también en versión LED. Vidrio opalino blanco.

Applique, lampe de table, lampe au sol et plafonniers en laiton brillant ou nickel satiné. Applique et plafonniers en metal blanc disponible aussi en version LED. Verre opaline blanc.

Настенные, настольные, напольные и потолочные светильники в отделках полированная латунь или матовый никель. Настенные и потолочные светильники доступны в LED версии. Опаловое стекло.





Tecla_



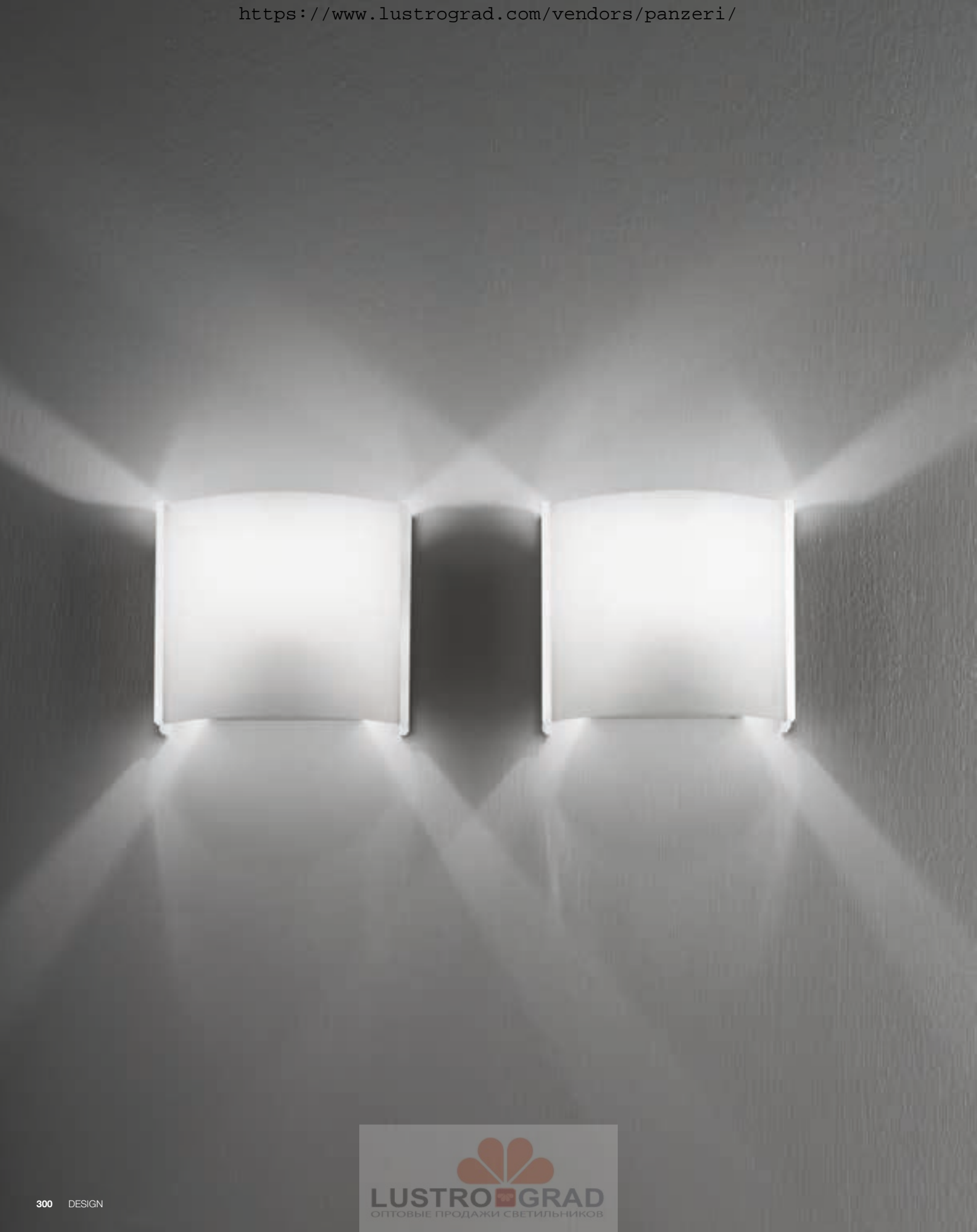



Tecla_

design_Friedrich Reiffer 1995

IP20 (Table / Floor)

Energy Label available at www.panzeri.it

220 / 240 V

	CODICE / CODE	CM Ø / A x B	H	INCHES Ø / A x B	H	LED	FLUO	HALO
Soffitto / Ceiling	P 4001.40 LED	40x40	10	15 3/4" x 15 3/4"	4"	23W 3000K Ra80 2400lm		
	P 40__40	40x40	10	15 3/4" x 15 3/4"	4"			max 160W R7s 117 mm
	P 40__40 INC	40x40	10	15 3/4" x 15 3/4"	4"		2x max 23W Micro Twist E27	2x max 70W E27
	P 4001.60 LED	60x60	12	23 1/2" x 23 1/2"	4 3/4"	26W 3000K Ra80 3080lm		
	P 40__60	60x60	12	23 1/2" x 23 1/2"	4 3/4"		4x max 23W Micro Twist E27	4x max 70W E27
	P 40__60 FLUO	60x60	12	23 1/2" x 23 1/2"	4 3/4"		2x36W/827 2G11	
Parete / Wall	A 4101.12 LED	13 x 5	13	5 1/8" x 2"	5 1/8"	6W 3000K Ra80 730lm		
	A 41__12	13 x 5	13	5 1/8" x 2"	5 1/8"			max 60W G9
	A 4101.20 LED	20 x 7	17	7 3/4" x 2 3/4"	6 3/4"	12W 3000K Ra80 1460lm		
	A 41__20	20 x 7	17	7 3/4" x 2 3/4"	6 3/4"		max 18W Micro Twist E27	max 100W E27
	A 4101.30 LED	30 x 8	21	11 3/4" x 3 1/8"	8 1/4"	18W 3000K Ra80 2190lm		
	A 41__30	30 x 8	21	11 3/4" x 3 1/8"	8 1/4"		max 23W Micro Twist E27	max 150W E27
Tavolo / Table	C 40__20	20x11	37	7 3/4" x 4 1/4"	14 5/8"			max 60W E14
	C 40__30	30x11	50	11 3/4" x 4 1/4"	19 3/4"		max 23W Micro Twist E27	max 150W E27
Terra / Floor	T 40__	28	181	11"	71 1/4"			max 205W E27 dimmer

Fotometrie disponibili www.panzeri.it / Photometric data available at www.panzeri.it

CODICI COLORI DISPONIBILI / COLOURS CODES AVAILABLE

01 Bianco (solo per versione LED)
White (only for LED version)

20 Ottone lucido
Polished brass

32 Nichel
Nickel



Cross_

Design_Andrea Lazzari 2012



Lampade da parete in metallo bianco, rame lucido. A richiesta foglia oro o foglia argento. Diffusore in vetro acidato. Disponibile anche in versione LED.

Wall lamps in white metal, polished copper. On request gold or silver leaf. Etched glass diffuser. LED version also available.

Wandleuchten in weißem Metall, Kupfer glänzend. Auf Anfrage Blattgold oder Blattsilber. Geätztes Mattglas. Auch in LED Ausführung.

Lámparas de pared en metal blanco, cobre lúcido. A petición pan de oro o pan de plata. Difusor in vidrio grabado. Disponible también en versión LED.

Appliques en métal blanc, cuivre brillant. Sur demande feuille d'or ou feuille d'argent. Diffuseur en verre gravé. Disponible aussi en version LED.

Настенные светильники из металла. Доступные отделки: белый, медь. Сусальное золото и сусальное серебро доступны по запросу. Диффузор из травленного стекла. Также доступна LED





Cross_

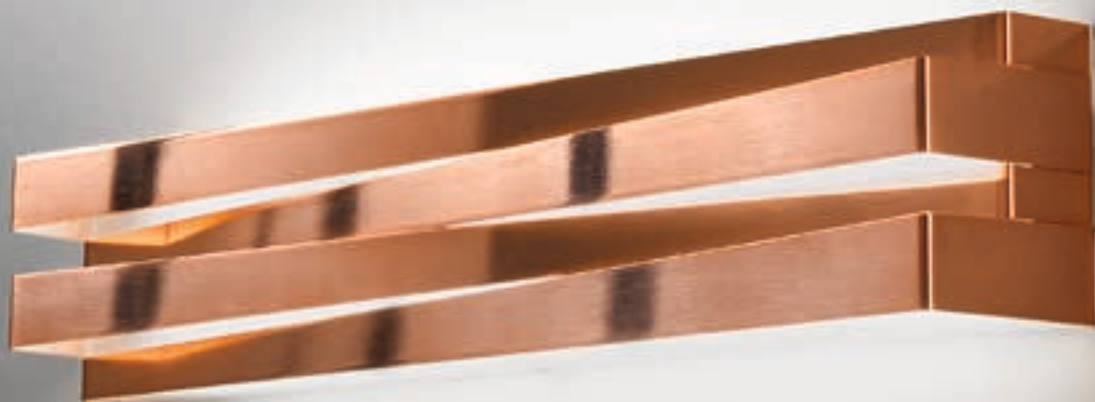



Cross_

Cross_		design_Andrea Lazzari 2012				LED CE IP40		
Energy Label available at www.panzeri.it								
220 / 240 V								
	CODICE / CODE	CM A x B	H	INCHES A x B	H	LED	FLUO	HALO
Parete / Wall	*A 49_..30 LED	30 x 9	11,5	11 3/4" x 3 1/2"	4 1/2"	17W 3000K Ra80 2200lm		
	A 49_..30 FLUO	30 x 9	11,5	11 3/4" x 3 1/2"	4 1/2"		24W/830 2G10	
	A 49_..30 HALO	30 x 9	11,5	11 3/4" x 3 1/2"	4 1/2"			max 80W R7s 117 mm
	*A 49_..60 LED	60 x 9	11,5	23 5/8" x 3 1/2"	4 1/2"	34W 3000K Ra80 4400lm		
	A 49_..60 FLUO	60 x 9	11,5	23 5/8" x 3 1/2"	4 1/2"		2x24W/830 G5	
	A 49_..60 HALO	60 x 9	11,5	23 5/8" x 3 1/2"	4 1/2"			2x max 80W R7s 117 mm

Fotometrie disponibili www.panzeri.it / Photometric data available at www.panzeri.it

CODICI COLORI DISPONIBILI / COLOURS CODES AVAILABLE

- | | | | |
|----------------------------|---|---|--|
| 0 1 Bianco
White | 2 1 Foglia oro (a richiesta)
Gold leaf (available on request) | 2 3 Foglia argento (a richiesta)
Silver leaf (available on request) | *2 5 Rame lucido
Polished copper |
|----------------------------|---|---|--|



Candle_

Design_Silvia Poma 2006

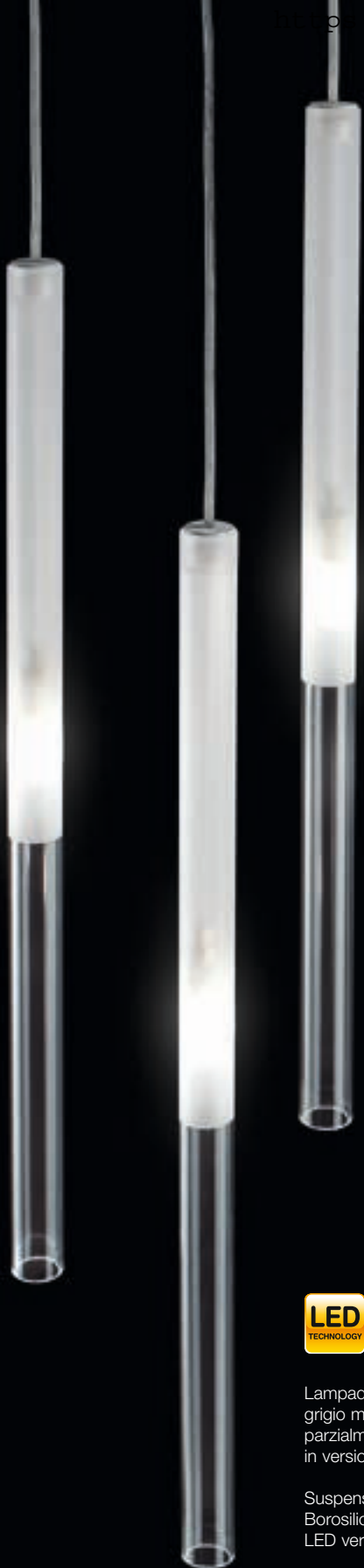

Lampade a sospensione con rosni grigio metallizzato. Vetri in borosilicato parzialmente satinati. Disponibile anche in versione LED.

Suspensions in metallized grey metal. Borosilicate partially mat glasses. LED version also available.

Hängeleuchten in graumetallic mit teilweise satiniertem Borosilikatglas. Auch in LED- Ausführung.

Lámparas de suspensión en gris metalizado. Vidrios de borosilicato parcialmente satinados. Disponible también en versión LED.

Lampes suspension gris métallisé. Verres en borosilicate partiellement satinés. Disponible aussi en version LED.

Подвесные светильники с арматурой цвета серый металлик. Плафоны из частично сатинированного боросиликатного стекла. LED версия также доступна.



CONFINDUSTRIA
Monza e Brianza



Candle_



Confindustria - Monza, Italia

Candle_

design_Silvia Poma 2006



Energy Label available at www.panzeri.it

220 / 240 V

	CODICE / CODE		CM Ø / A x B	H	INCHES Ø / A x B	H	HALO	LED
Sospensione / suspension	L 9533 - LED		3	55	1 1/2"	22"		3,2W 3000K Ra80 320lm
	L 9533		3	55	1 1/2"	22"	max 48W G9	
Sospensione senza rosone per composizioni multiple Suspension without canopy for multiple compositions	M 9533 - S LED		3	55	1 1/2"	22"		3,2W 3000K Ra80 320lm 24V
	M 89__ - 42 LED	max 3 M95__-S LED*		42 x 6,5		16 1/2" x 2 1/2"		
	M 89__ - 76 LED	max 5 M95__-S LED*		76 x 6,5		30" x 2 1/2"		
	M 89__ - 25 LED	max 6 M95__-S LED*		42 x 25		16 1/2" x 9 7/8"		
	M 9533 - S		3	55	1 1/2"	22"	max 48W G9	
	M 89__ - 42	max 3 M95__-S		42 x 6,5		16 1/2" x 2 1/2"		
M 89__ - 76	max 5 M95__-S		76 x 6,5		30" x 2 1/2"			
M 89__ - 25	max 6 M95__-S		42 x 25		16 1/2" x 9 7/8"			

Fotometrie disponibili www.panzeri.it / Photometric data available at www.panzeri.it

* incluso 24V dc driver
24V dc driver included

CODICI COLORI DISPONIBILI / COLOURS CODES AVAILABLE

- | | |
|--|---|
| 0 1 Bianco (solo per barre)
White (only for track) | 3 3 Grigio metallizzato
Metallized grey |
|--|---|



Lampada da parete, plafoniere e
sospensione in grigio metallizzato.
Vetro soffiato bianco satinato.

Wall, ceiling lamps and suspension in
metallized grey metal. Blown white mat
glass.

Wand-, Hänge- und Deckenleuchte in
graumetalllic. Mundgeblasenes Glas
weiß satiniert.

Lámpara de pared, plafónes y
suspensiones gris metalizado. Vidrio
soplado blanco satinado.

Applique, plafonniers et suspension en
gris métallisé. Verre soufflé blanc satiné.

Настенные, потолочные и подвесные
светильники. Цвет арматуры серый
металлик. Матовое выдувное стекло
белого цвета.





Alvi_



Alvi_



Alvi_	design_Enzo Panzeri 2003						CE IP20 
Energy Label available at www.panzeri.it							
	CODICE / CODE	CM Ø / A x B	H	INCHES Ø / A x B	H	HALO	
Sospensione / Suspension	L 8533	17	36	6 ¾"	14 ¼"	max 150W E27	
Soffitto / Ceiling	P 8533 - 1	17	24	6 ¾"	6 ½"	max 150W E27	
	P 8533 - 3	31	30	12 ¼"	11 ¾"	3x max 70W E27	
Parete / Wall	A 8533.20	17 x 8	20	6 ¾" x 3 ⅛"	7 ¾"	max 70W E27	
	A 8533.40	17 x 8	36	6 ¾" x 3 ⅛"	14 ¼"	max 150W E27	

CODICI COLORI DISPONIBILI / COLOURS CODES AVAILABLE

33 Grigio metallizzato
Metallized grey



Zenith_

Design_Friedrich Reiffer 1999



Lampade da parete/soffitto in grigio metallizzato. Vetro soffiato bianco satinato.

Wall/ceiling lamps in metallized grey metal. Blown white mat glass.

Wand- Deckenleuchte in graumetallic. Mundgeblasenes, weißes Mattglas.

Lámpara de pared/techo color gris metalizado. Vidrio soplado blanco satinado.

Applique/plafon en gris métallisé. Verre soufflé blanc satiné.

Настенные и настенно — потолочные светильники. Арматура серый металл. Матовое выдувное стекло белого цвета.



Zenith_





Zenith_

design_Friedrich Reiffer 1999

CE IP20 

Energy Label available at www.panzeri.it

	CODICE / CODE	CM A x B	H	INCHES A x B	H	FLUO	HALO
Parete / Wall	A 6333.30	15 x 8	32	6" x 3 1/8"	12 1/2"	max 23W Micro Twist E27	max 150W E27
	A 6333.65	16 x 8	65	6 1/4" x 3 1/8"	25 1/2"	2x max 23W Micro Twist E27	2x max 100W E27
	A 6333.95	23 x 10	95	9" x 4"	37 1/2"	4x max 23W Micro Twist E27	4x max 100W E27

CODICI COLORI DISPONIBILI / COLOURS CODES AVAILABLE

33 Grigio metallizzato
Metallized grey

Tourbillon_

Design_Enzo Panzeri 2006

Lampada da terra, da soffitto, da parete e sospensioni in vetro soffiato. Montatura in metallo bianco con particolari nichelati.

Floor, ceiling, wall lamp and suspensions in blown glass. White metal and nickel details.

Steh-, Hänge-, Wand- und Deckenleuchte aus weißem Metall und Details aus Nickel. Mundgeblasene Gläser.

Lámpara de suelo, de pared, de plafón y suspensiones en vidrio soplado. Montura de metal blanco con detalles niquelados.

Lampe au sol, plafonniers, applique et suspensions en verre soufflé. Monture en métal blanc avec détails en nickel.

Напольные, потолочные, настенные и подвесные светильники выдувного стекла. Арматура из металла белого цвета с никелированными деталями.







Tourbillon_



Tourbillon_

design_Enzo Panzeri 2006

CE IP20 

Energy Label available at www.panzeri.it

220 / 240 V

	CODICE / CODE	CM Ø / A x B	H	INCHES Ø / A x B	H	FLUO	HALO
Sospensione / Suspension	L 9632	46	40	18 1/8"	15 3/4"	20W Miniglobe E27 Ø 95 mm	
Soffitto / Ceiling	P 9632	49 x 43	13	19 1/4" x 17"	5 1/8"		max 160W R7s 117 mm
	P 9632.45	46	48	18 1/8"	18 7/8"	20W Miniglobe E27 Ø 95 mm	
Parete / Wall	A 9632	27 x 8	18	10 1/2" x 3 1/8"	7"		max 80W R7s 78 mm
Terra / Floor	T 9632	46	190	18 1/8"	74 3/4"		max 205W E27 dimmer

CODICI COLORI DISPONIBILI / COLOURS CODES AVAILABLE

32 Nichel
Nickel

W/W WHITE/WHITE

W/B WHITE/BLACK



Lucilla_

Design_Enzo Panzeri 1998

Lampada da terra e da tavolo grigio metallizzato. Vetro soffiato bianco satinato.

Table and floor lamps in metallized grey metal. Blown white mat glass.

Tisch- und Stehleuchte in graumetallic. Geblasenes weißes Mattglas.

Lámpara de suelo y de mesa gris metalizado. Vidrio soplado blanco satinado.

Lampe au sol et lampe de table gris métallisé. Verre soufflé blanc ou ambre satiné.

Настольные и напольные светильники цвета серый металл. Белое матовое выдувное стекло.





Lucilla_

Lucilla_		design_Enzo Panzeri 1998				CE IP20 (Table) 	
Energy Label available at www.panzeri.it							
220 / 240 V							
	CODICE / CODE	CM Ø	H	INCHES Ø	H	FLUO	HALO
Tavolo / Table	C 6133.35	15	45	6"	17 3/4"		max 60W E14
	C 6133.50	24	68	9 1/2"	26 3/4"	max 23W Micro Twist E27	max 150W E27
Terra / Floor	T 6133	48	180	18 3/4"	70 3/4"		4x max 70W E27 dimmer
	T 6832	30	171	11 3/4"	67 1/4"		3x max 70W E27 dimmer

CODICI COLORI DISPONIBILI / COLOURS CODES AVAILABLE

- | | |
|---|---|
| 3 2 Nichel (solo per T68)
Nickel (only for T68) | 3 3 Grigio metallizzato
Metallized grey |
|---|---|



Classic_

Design_Team Design 1979



Lampada da terra estensibile, da tavolo, e da parete in ottone lucido o cromo, con paralume bianco.

Extending floor, table and wall lamp in polished brass in chrome and white shade.

Tisch-, Wand-, und Stehleuchte dreh- und schwenkbar aus Messing oder in Chrom mit weißem Stoffschirm.

Lámpara de suelo extensible, de mesa, y de pared de latón lúcido o cromado con pantalla blanca.

Lampe au sol extensible, lampe de table et applique en laiton brillant ou chrome avec abat-jour blanc.

Настольные лампы, бра, регулируемый торшер. Цвет глянцевая латунь или хром, белый абажур.



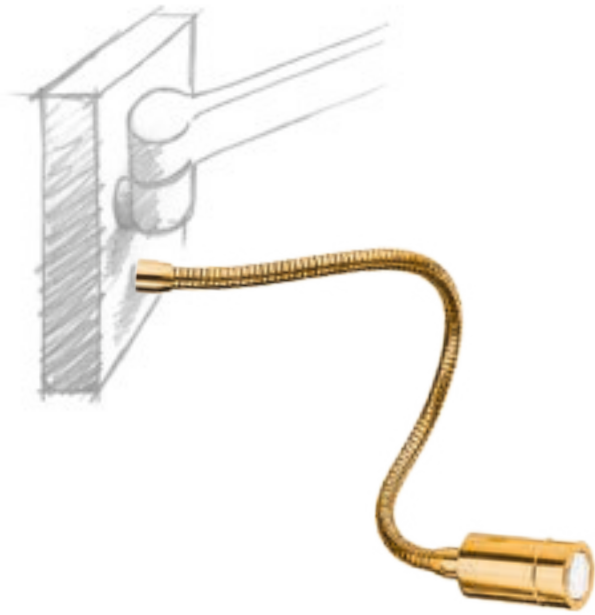

Per progetti, disponibili su richiesta versioni a parete con flessibile a LED, ottone o cromo, completo di driver e interruttore.

Wall-mounted version available on request in brass or chrome, includes flexible LED, complete with driver and switch.

Für Projekte sind auf Anfrage Wandausführungen mit biegsamem Rohr mit LED-Aufsatz aus Messing oder Chrom, mit Treiber und Schalter lieferbar.

Para proyectos disponibles a su petición versiones para pared con flexible y LED, latón o cromo, con driver e interruptor.

Pour les projets sont disponibles sur demande des versions à parois avec flexible à LED, en laiton ou en chrome, complet avec driver et interrupteur.

Для проектов возможны настенные варианты со светодиодными лентами, латунь или хром, в комплекте с драйвером и выключателем.

Classic_







Classic_		design_Team Design 1979			CE IP20 (☐ Table / Floor)	
Energy Label available at www.panzeri.it						
	CODICE / CODE	CM Ø	H	INCHES Ø	H	FLUO HALO
Parete / Wall	A 24__ - 1	27 → 32	26	10 ½" → 12 ½"	10 ¼"	max 18W Micro Twist E27 max 53W E27
	M 24 - 1	Schermo in vetro A 24__ - 1 Glass screen A 24__ - 1	22	8 ½"		
	A 24__ - 2	30 → 49	29	11 ¾" → 19 ¼"	11 ½"	max 18W Micro Twist E27 max 53W E27
	M 24 - 1	Schermo in vetro A 24__ - 2 Glass screen A 24__ - 2	22	8 ½"		
Tavolo / Table	C 24__	27	39	10 ½"	15 ¼"	max 18W Micro Twist E27 max 53W E27
	M 24 - 1	Schermo in vetro C 24__ - 1 Glass screen C 24__ - 1	22	8 ½"		
	C 24__ - 2	30 → 44	50	11 ¾" → 17 ¼"	19 ¾"	max 18W Micro Twist E27 max 53W E27
	M 24 - 2	Schermo in vetro C 24__ - 2 Glass screen C 24__ - 2	25	10"		
Terra / Floor	T 24__ - 2	40 → 64	130 → 170	15 ¾" → 25 ½"	51 ¼" → 67"	max 23W Micro Twist E27 max 70W E27
	M 24 - 3	Schermo in vetro T 24__ - 2 Glass screen T 24__ - 2	36	14 ¼"		
		CM Ø	H	INCHES Ø	H	LED
Flessibile a LED per versioni a parete (su richiesta) Flexible LED for wall-mounted version (available on request)		2,5	35	1"	13 ¾"	1,7W 3000K Ra 80 160lm 220 - 240 V

CODICI COLORI DISPONIBILI / COLOURS CODES AVAILABLE

20 Ottone lucido Polished brass **22** Cromo Chrome



Carré_

Design_Team Design 2006



Lampada da tavolo, lampada da terra e parete estensibile in ottone cromato con paralume quadrato bianco.

Table, floor and adjustable wall lamps in chrome plated brass. Square white lampshade.

Steh-, Tisch- und schwenkbare Wandleuchte aus verchromtem Messing. Quadratischer Lampenschirm in Weiß.

Lámpara de mesa, de suelo y de pared extensible de latón cromado con pantalla cuadrada blanca.

Lampe de table, au sol et applique extensible en laiton chromé avec abat-jour carré blanc.

Настольные, напольные и регулируемые настенные светильники из хромированной латуни с белыми квадратными абажурами.





Carré_

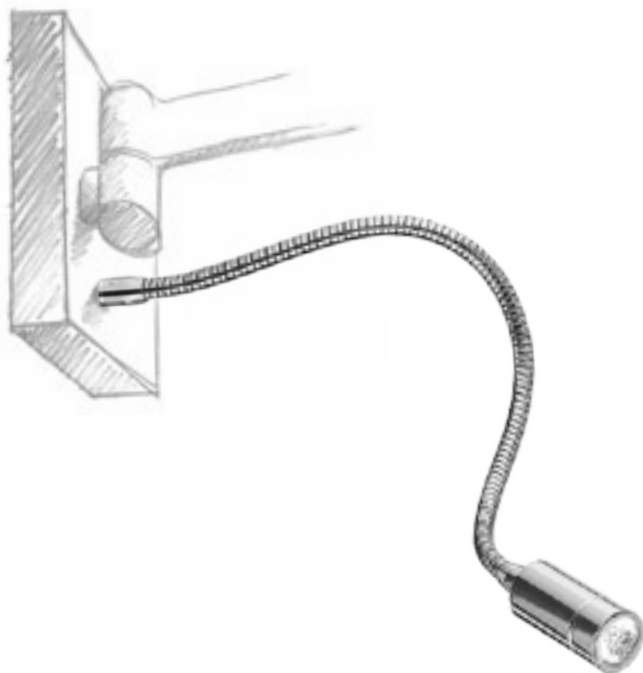

Per progetti, disponibili su richiesta versioni a parete con flessibile a led, ottone o cromo, completo di driver e interruttore.

Wall-mounted version available on request in brass or chrome, includes flexible LED, complete with driver and switch.

Für Projekte sind auf Anfrage Wandausführungen mit biegsamem Rohr mit LED-Aufsatz aus Messing oder Chrom, mit Treiber und Schalter lieferbar.

Para proyectos disponibles a su petición versiones para pared con flexible y LED, latón o cromo, con driver e interruptor.

Pour les projets sont disponibles sur demande des versions à parois avec flexible à led, en laiton ou en chrome, complet avec driver et interrupteur.

Для проектов возможны настенные варианты со светодиодными лентами, латунь или хром, в комплекте с драйвером и выключателем.

Carré_

design_Team Design 2006

CE IP20 (Table / Floor)

Energy Label available at www.panzeri.it

	CODICE / CODE	CM A x B	H	INCHES A x B	H	FLUO	HALO
Parete / Wall	A 2322 - 1	28 x 28 → 40	26	11" x 11" → 15 3/4"	10 1/4"	max 18W Micro Twist E27	max 53W E27
	A 2322 - 2	28 x 28 → 60	29	11" x 11" → 23 5/8"	11 3/8"	max 18W Micro Twist E27	max 53W E27
Tavolo / Table	C 2322	28 x 28	49	11" x 11"	19 1/4"	max 18W Micro Twist E27	max 53W E27
Terra / Floor	T 2322	28 x 28	170	11" x 11"	67"	max 23W Micro Twist E27	max 70W E27
Schermo in vetro Glass screen	M 23	24 x 24		9 1/2" x 9 1/2"			

	CM Ø	H	INCHES Ø	H	LED
Flessibile a LED per versioni a parete (su richiesta) Flexible LED for wall-mounted version (available on request)	2,5	35	1"	13 4/5"	1,7W 3000K Ra 80 160lm 220 - 240 V

CODICI COLORI DISPONIBILI / COLOURS CODES AVAILABLE

22 Cromo
Chrome



Blissy_

Design_Silvia Poma 2003



Lampada da terra, da tavolo e da parete in grigio metallizzato o marrone metallizzato.
Paralumi in avorio plissé oppure bianco.
Schermi in vetro inclusi, eccetto nella versione terra.

Floor, table and wall lamp in metallized grey or metallized brown. Ivory plissé or white lampshade. Glass screen included, except for floor lamp.

Steh-, Tisch- und Wandleuchte in graumetallic oder braunmetallic.
Elfenbein plissé oder weißer Stoffschirm.
Inklusiv Glasschirm außer bei Stehleuchte.

Lámpara de suelo, de mesa y de pared gris metalizado o marrón metalizado.
Pantalla plisada marfil o pantalla blanca.
Incluso eschermo en vidrio, no para la version tierra.

Lampe au sol, lampe de table et applique en gris métallisé ou brun métallisé. Abat-jour en plissé ivoire ou blanc. Ecrans en verre inclus, sauf pour la lampe au sol.

Напольные, настольные и настенные светильники, арматура - серый металл или коричневый металл.
Абажуры белые либо плиссированные цвета слоновой кости. Укомплектованы стеклянным экраном за исключением напольных светильников.







Blissy_

design_Silvia Poma 2003

CE IP20 (☐ Table / Floor) ⚡

Energy Label available at www.panzeri.it

220 / 240 V

	CODICE / CODE	CM A x B	H	INCHES A x B	H	FLUO	HALO
Parete / Wall	A 84 - PL	29 x 10	18	11 1/2" x 4"	7"		max 70W E27
	A 84 FLUO - PL	29 x 10	18	11 1/2" x 4"	7"	26W/827 G24 q-3	
	A 84 - PB	29 x 10	18	11 1/2" x 4"	7"		max 53W E27
	A 84 FLUO - PB	29 x 10	18	11 1/2" x 4"	7"	26W/827 G24 q-3	
Tavolo / Table	C 84__30 - PL	29 x 13,5	29	11 1/2" x 5 1/4"	11 1/2"	max 23W Micro Twist E27	max 53W E27
	C 84__30 - PB	29 x 13,5	29	11 1/2" x 5 1/4"	11 1/2"	max 23W Micro Twist E27	max 53W E27
	C 84__50 - PL	45 x 19	43	17 3/4" x 7 1/2"	17"	max 30W Superstar E27	max 150W E27
	C 84__50 - PB	45 x 19	43	17 3/4" x 7 1/2"	17"	max 30W Superstar E27	max 150W E27
Terra / Floor	T 84__ - PL	45 x 19	166	17 3/4" x 7 1/2"	65 1/4"		max 150W E27 dimmer
	T 84__ - PB	45 x 19	166	17 3/4" x 7 1/2"	65 1/4"		max 150W E27 dimmer

CODICI COLORI DISPONIBILI / COLOURS CODES AVAILABLE

3 3 Grigio metallizzato
Metallized grey

4 4 Marrone metallizzato
Metallized brown

PL Paralume plissé
Plisse' lampshade

PB Paralume bianco
White lampshade



Night_

Design_Valerio Bottin 2009



Private house - Toscana, Italia

Lampade da parete/soffitto in vetro soffiato bianco satinato. Montature in metallo bianco.

Wall/ceiling lamps in mat blown white glass. White metal fitting.

Wand-/Deckenleuchten aus geblasenem Glas weiß satiniert. Weiße Metallstruktur.

Lámparas de pared/techo en cristal soplado blanco satinado. Monturas en metal blanco.

Appliques/plafonniers en verre soufflé blanc satiné. Montures en métal blanc.

Потолочный/настенный светильник из сатинированного белого выдувного стекла. Арматура - металл белого цвета.





Night_



Night_

design_Valerio Bottin 2009

CE IP40

Energy Label available at www.panzeri.it

220 / 240 V

	CODICE / CODE	CM A x B	H	INCHES A x B	H	FLUO	HALO
Soffitto-parete / Ceiling-wall	P 2901.30 HALO	32 x 10	32	12 1/2" x 4"	12 1/2"		max 160W R7s 117 mm
	P 2901.30 FLUO	32 x 10	32	12 1/2" x 4"	12 1/2"	2x26W/827 G24 q-3	
	P 2901.50 HALO	22 x 10	50	8 3/8" x 4"	19 3/4"		max 160W R7s 117 mm
	P 2901.50 FLUO	22 x 10	50	8 3/8" x 4"	19 3/4"	2x26W/827 G24 q-3	

CODICI COLORI DISPONIBILI / COLOURS CODES AVAILABLE

01 Bianco
White



Viki_

Design_Team Design 2011



Lampade da soffitto e sospensioni in tessuto bielastico ignifugo.

Hänge-, und Deckenleuchten aus feuerfestem, bi-elastischem Stoff.

Plafonniers et suspensions en tissu biélastique ignifuge.

Ceiling lamps and suspensions in bi-elastic, fire resistant fabric.

Lámparas de techo y suspensiones raso en tela elastica ignifugo.

Потолочные и подвесные светильники из невоспламеняемой ткани бифлекс.





Viki_



Viki_ design_Team Design 2011 Registered Design **CE** IP20 

Energy Label available at www.panzeri.it

	CODICE / CODE	CM Ø	H	INCHES Ø	H	FLUO	HALO
Sospensione / Suspension	L 4101.55	55	18	21 ½"	7"	2x max 30W Superstar E27	2x max 53W E27
	L 4101.75	75	22	29 ½"	8 ½"	3x max 30W Superstar E27	3x max 53W E27
Soffitto / Ceiling	P 4101.55	55	18	21 ½"	7"	2x max 30W Superstar E27	2x max 53W E27
	P 4101.75	75	22	29 ½"	8 ½"	3x max 30W Superstar E27	3x max 53W E27

CODICI COLORI DISPONIBILI / COLOURS CODES AVAILABLE

01 Bianco
White



Dreamy_

Design_Valerio Bottin 2009



Sospensioni, lampade a parete/soffitto in bianco con vetro soffiato bianco satinato. Lampade da tavolo in bianco o cromo con vetro soffiato bianco satinato.

Suspensions, wall/ceiling lamps in white and mat blown white glass. Table lamps in white or chrome and mat blown white glass.

Hänge-, Wand-/Deckenleuchten aus weißem Metall mit geblasenem Glas weiß satiniert. Tischleuchten aus weißem oder verchromtem Metall mit geblasenem Glas, weiß satiniert.

Suspensiones, lámparas de pared/techo en blanco con cristal soplado blanco satinado. Lámparas de mesa en blanco o cromo con cristal soplado blanco satinado.

Suspensions, appliques/plafonniers en blanc avec verre soufflé blanc satiné. Lampes de table en blanc ou chrome avec verre soufflé blanc satiné.

Подвесные, потолочные/настенные светильники с арматурой белого цвета, сатинированное белое выдувное стекло. Настольные лампы с белой или хромированной арматурой, сатинированное белое выдувное стекло.



Dreamy_









Dreamy_



Dreamy_

design_Valerio Bottin 2009

CE IP20 (Table)  

Energy Label available at www.panzeri.it

	CODICE / CODE	CM Ø / A x B H	INCHES Ø / A x B H	FLUO	HALO
Sospensione / Suspension	L 2801.25	25 20	10" 7 3/4"		max 60W G9
	L 2801.40	42 35	16 1/2" 13 3/4"	max 23W Micro Twist E27	max 150W E27
Soffitto-parete / Ceiling-wall	P 2801.25	25 x 20 18	10" x 7 3/4" 7"	max 18W Micro Twist E27	max 100W E27
	P 2801.40	42 x 35 26	16 1/2" x 13 3/4" 10 1/4"	max 23W Micro Twist E27	max 150W E27
Tavolo / Table	C 28__25	25 23	10" 9"		max 60W G9
	C 28__40	42 39	16 1/2" 15 3/8"	max 23W Micro Twist E27	max 150W E27

CODICI COLORI DISPONIBILI / COLOURS CODES AVAILABLE

01 Bianco
White

22 Cromo
Chrome



Track_

Design_Valerio Bottin
Giampaolo Mengato 2008



Lampada da terra, da tavolo, da parete/soffitto e sospensione in grigio metallizzato o bianco. Vetro soffiato bianco satinato.

Floor, table, wall/ceiling and suspension lamp in metallized grey or white metal. Blown white mat glass.

Steh-, Tisch-, Wand-/Decken- und Hängeleuchte in graumetallic oder weiß. Mundgeblasenes weißes Mattglas.

Lámpara de suelo, mesa, pared/techo y suspensión en gris metalizado o blanco. Vidrio soplado blanco satinado.

Lampe au sol, de table, applique, plafonnier et suspension en gris métallisé ou blanc. Verre soufflé blanc satiné.

Торшер, настольная лампа, потолочный/настенный и подвесной светильники, цвет серый металл или белый. Белое сатирированное выдувное стекло.







Track_

design_Valerio Bottin_Giampaolo Mengato 2008

CE IP40 (☐ Table / Floor) ⚡

Energy Label available at www.panzeri.it

	CODICE / CODE	CM Ø / A x B	H	INCHES Ø / A x B	H	HALO
Sospensione / suspension	L 18_ _	12	40	4 ¾"	15 ¾"	max 150W B15d
Sospensione senza rosone per composizioni multiple Suspension without canopy for multiple compositions	M 18_ _ - 5		40	4 ¾"	15 ¾"	max 150W B15d
	M 89_ _ - 42	max 3 M18_ _-S	42 x 6,5	16 ½" x 2 ½"		
	M 89_ _ - 76	max 5 M18_ _-S	76 x 6,5	30" x 2 ½"		
	M 89_ _ - 25	max 6 M18_ _-S	42 x 25	16 ½" x 9 ⅞"		
Soffitto-parete / Ceiling-wall	P 1801	40 x 12	12	15 ¾" x 4 ¾"	4 ¾"	max 120W R7s 78 mm
Tavolo / Table	C 18_ _	22	41	8 ⅝"	16"	max 60W G9
Terra / Floor	T 18_ _	22	185	8 ⅝"	72 ¾"	max 150W B15d

CODICI COLORI DISPONIBILI / COLOURS CODES AVAILABLE

0 1 Bianco
White

3 3 Grigio metallizzato
Metallized grey



Floral_

Design_Hiroki Takada 2007

Lampade da terra, da tavolo, da soffitto e sospensioni in alluminio. Montature in metallo cromato con diffusore in pyrex.

Floor, table, ceiling and suspensions in aluminium. Fittings in chromed metal with pyrex diffuser.

Steh-, Tisch-, Decken und Hängeleuchten aus Aluminium. Struktur aus verchromtem Metall mit Pyrexglas.

Lámpara de suelo, de mesa, de plafón y suspensión en aluminio. Montura en metal cromado con difusor en pyrex.

Lampe au sol, de table, plafonnier et suspensions en aluminium. Monture en métal chromé avec diffuseur en pyrex.

Торшер, настольные лампы, потолочные и подвесные светильники из алюминия. Арматура из хромированного металла, рассеиватель из стекла pyrex.





Floral_





Floral_



Floral_

design_Hiroki Takada 2007

CE IP20 (☐ Table / Floor) 🗺

Energy Label available at www.panzeri.it

220 / 240 V

	CODICE / CODE	CM Ø	H	INCHES Ø	H	FLUO	HALO
Sospensione / Suspension	L 1322.20	20		7 ¾"			max 48W G9
	L 1322.40	40		15 ¾"		max 18W Superstar E27	max 150W E27
	L 1322.60	60		23 ⅝"		max 30W Superstar E27	max 150W E27
Soffitto / Ceiling	P 1322.20	20		7 ¾"			max 48W G9
	P 1322.40	40		15 ¾"		max 18W Superstar E27	max 150W E27
Tavolo / Table	C 1322.20	20		7 ¾"			max 48W G9
	C 1322.40	40		15 ¾"		max 18W Superstar E27	max 150W E27
	C 1322.60	60		23 ⅝"			max 150W E27 dimmer
Terra / Floor	T 1322	40	195	15 ¾"	76 ¾"		max 150W E27 dimmer

CODICI COLORI DISPONIBILI / COLOURS CODES AVAILABLE

22 Cromo
Chrome



Spyra_

Design_Enzo Panzeri 2001



Lampada da terra, da tavolo, da soffitto e da parete in nichel satinato. Vetro soffiato bianco satinato.

Floor, table, suspension and wall lamp in mat nickel metal. Blown white mat glass.

Tisch-, Wand-, Hänge- und Stehleuchte in Nickel satiniert. Mundegeblasenes Glas weiß satiniert.

Lámpara de suelo, de mesa, de techo y de pared de níquel satinado. Vidrio soplado blanco satinado.

Lampe au sol, lampe de table, de plafond et applique en nickel satiné. Verre soufflé blanc satiné.

Торшер, настольные лампы, бра, подвесные светильники с арматурой цвета матовый никель. Белое сатинированное выдувное стекло.





Spyra_



Spyra_

design_Enzo Panzeri 2001

Disegno Registrato

CE IP20 (Table) 

Energy Label available at www.panzeri.it

220 / 240 V

	CODICE / CODE	CM A x B	H	INCHES A x B	H	FLUO	HALO
Sospensione / Suspension	L 7132.35	20 x 20	33	7 3/4" x 7 3/4"	13"	max 30W Superstar E27	max 150W E27
	L 7132.60	29 x 29	64	11 1/2" x 11 1/2"	25 1/4"	max 30W Superstar E27	max 150W E27
Parete / Wall	A 7132	20 x 13	33	7 3/4" x 5 1/8"	13"	max 30W Superstar E27	max 100W E27
Tavolo / Table	C 7132.35	20 x 20	35	7 3/4" x 7 3/4"	13 3/4"	max 30W Superstar E27	max 100W E27
	C 7132.60	29 x 29	67	11 1/2" x 11 1/2"	26 1/4"	max 30W Superstar E27	max 150W E27
Terra / Floor	T 7332	28 x 28	180	11" x 11"	70 3/4"		4x max 100W E27 dimmer

CODICI COLORI DISPONIBILI / COLOURS CODES AVAILABLE

32 Nichel
Nickel



Rimmel_

Design_Valerio Bottin 2008

Sospensioni con particolari cromati.
Lampade da parete in metallo
verniciato bianco. Vetri opalino bianco.

Hängeleuchten mit Details aus Chrom.
Wandleuchten aus weiß lackiertem
Metall. Weißes Opalglas.

Suspensions avec parties chromées.
Appliques en métal peinté blanc.
Verres opalin blanc.

Suspensions with chromed details.
Wall lamps in white painted metal.
White opal glasses.

Suspensiones con detalles cromados.
Lámparas de pared en metal lacado
blanco. Vidrios blanco opal.

Подвесные светильники с
хромированными деталями.
Бра из металла белого цвета.
Белое опаловое стекло.







Rimmel_



Rimmel_

design_Valerio Bottin 2008

CE IP20 (☐ Suspension)

Energy Label available at www.panzeri.it

	CODICE / CODE	CM A x B	H	INCHES A x B	H	HALO
Sospensione / Suspension	L 1722.50	50 x 21	11	19 3/4" x 8 1/4"	4 1/2"	max 120W R7s 78 mm
	L 1722.70	70 x 25	14	27 1/2" x 10"	5 1/2"	max 160W R7s 117 mm
Parete / Wall	A 1722.50	50 x 10	11	19 3/4" x 4"	4 1/2"	max 120W R7s 78 mm
	A 1722.70	70 x 13	12	27 1/2" x 5 1/8"	4 3/4"	max 160W R7s 117 mm

CODICI COLORI DISPONIBILI / COLOURS CODES AVAILABLE

22 Cromo
Chrome



Bonbon_

Design_Valerio Bottin 2011



Lampada da tavolo, da parete e sospensione in vetro soffiato bianco satinato. Montatura in nichel satinato.

Suspension, wall and table lamps in nickel. Blown white mat glass.

Tisch-, Wand- und Hängeleuchte aus weiß satiniertem, Mundgeblasenem Glas Struktur in Nickel satiniert.

Suspension, lámpara de mesa, de pared en vidrio soplado blanco satinado. Montura en níquel.

Suspension, applique, lampe de table en verre soufflé blanc satiné. Montare en nickel satiné.

Настольные лампы, бра и подвесной светильник из выдувного белого сатинированного стекла. Арматура - сатинированный никель.





Bonbon_

Bonbon_

design_Valerio Bottin 2011

Registered Design

CE IP20 (Table)  

Energy Label available at www.panzeri.it

220 / 240 V

	CODICE / CODE	CM Ø	H	INCHES Ø	H	HALO
Sospensione / Suspension	L 4332.18	18	21	7"	8 ¼"	max 60W G9
Parete / Wall	A 4332.18	18	16	7"	6 ¼"	max 60W G9
Tavolo / Table	C 4332.18	18	16	7"	6 ¼"	max 60W G9
	C 4332.45	45	42	17 ¾"	16 ½"	max 150W E27 dimmer

CODICI COLORI DISPONIBILI / COLOURS CODES AVAILABLE

3 2 Nichel
Nickel



Delphina_

Design_Friedrich Reiffer 1995

Lampade da parete/soffitto in metallo bianco e vetro soffiato bianco satinato.

Wand/Deckenleuchten weiß lackiert. Mundgeblasenes Glas, weiß satiniert.

Applique/plafonnier en metal blanc et verre soufflé blanc satiné.

Wall/ceiling lamp in white metal. Blown white mat glass.

Lámparas de pared/techo de metal blanco y vidrio soplado blanco satinado.

Настенно — потолочные светильники, цвет серый металл. Белое матовое выдувное стекло.

Delphina_

design_Friedrich Reiffer 1995

CE IP20 

Energy Label available at www.panzeri.it

	CODICE / CODE	CM Ø H	INCHES Ø H	HALO
Soffitto / Ceiling	P 4601.20	20 11	7 ¾" 4 ¼"	max 48W G9
	P 4601.30	30 16	11 ¾" 6 ¼"	max 120W R7s 78 mm
	P 4601.43	43 16	17" 6 ¼"	max 120W R7s 78 mm

CODICI COLORI DISPONIBILI / COLOURS CODES AVAILABLE

01 Bianco
White





Glim_

Design_Enzo Panzeri 2004

Lampada da terra, da plafone, da parete, da terra/parete in versione cromata, grigio metallizzato o bianca. Vetro borosilicato satinato e serigrafato.

Weiß, verchromte oder graumetallic Steh-, Decken-, Wand-, Steh/Wandleuchte. Borosilikatglas satiniert und bedruckt.

Lampe au sol, plafonnier, applique, lampe au sol/applique en version chromée, gris métallisé ou blanc. Verre borosilicate satiné et sérigraphé.

Floor, ceiling, wall and floor/wall lamps in chromed metal or metallized grey metal or white painted metal. Printed mat pyrex glass.

Lámpara de suelo, de plafón, de pared, de suelo/pared en versión cromada, gris metalizado o blanca. Vidrio borosilicado satinado y serigrafeado.

Торшер, бра, потолочный и напольный/настенный светильники. Цвет арматуры: хром, серый металл или белый. Сатинированное боросиликатное стекло с сериграфией.







Glim_



Glim_	design_Enzo Panzeri 2004			CE IP40 (<input type="checkbox"/> Floor / Floor-wall)		
Energy Label available at www.panzeri.it						
220 - 240 V						
					HALO	
Soffitto / Ceiling	P 87_ _	28 x 6	20	11" x 2 3/8"	7 3/4"	max 160W R7s 117 mm
Parete / Wall	A 87_ _	28 x 17	20	11" x 6 3/4"	7 3/4"	max 160W R7s 117 mm
Terra / Floor	T 87_ _	28	178	11"	70"	max 160W R7s 117 mm dimmer
Terra-parete / Floor-wall	A/T 87_ _	28 x 13	159	11" x 5 1/8"	62 1/2"	max 160W R7s 117 mm

CODICI COLORI DISPONIBILI / COLOURS CODES AVAILABLE

- | | | |
|---------------------------|---------------------------|--|
| 01 Bianco
White | 22 Cromo
Chrome | 33 Grigio metallizzato
Metallized grey |
|---------------------------|---------------------------|--|



All Halo_All Fluo_

Design_Enzo Panzeri 2005
restyling 2013



Lampada da parete e soffitto con cornice in alluminio sabbiato, bianco, foglia oro. Vetro satinato.

Ceiling and wall lamp with frame in sanded aluminium, white, gold leaf. Mat glass.

Decken- und Wandleuchten mit weißem oder sandgestrahltem Aluminium-Rahmen Blattgold. Glas satiniert.

Lámpara de pared y de techo con marco en aluminio arenado, blanco, pan de oro. Vidrio satinado.

Lampe de plafond et applique avec cadre en aluminium sablé, blanc, feuille d'or. Verre satiné.

Бра/потолочный светильник с рамкой из матового алюминия, белого цвета или в. Сатинированное стекло.





All Halo_All Fluo_



All Halo_All Fluo_ design_Enzo Panzeri 2005_restyling 2013

CE IP30

Energy Label available at www.panzeri.it

220 / 240 V

	CODICE / CODE	CM A x B	H	INCHES A x B	H	FLUO	HALO
Parete / Soffitto Wall / Ceiling	A 93_..50 HALO	37 x 6	37	14 1/2" x 2 3/8"	14 1/2"		max 160W R7s 117 mm
	A 93_..50 FLUO	37 x 6	37	14 1/2" x 2 3/8"	14 1/2"	2x18W/827 2G11	
	A 93_..65 HALO	37 x 6	55	14 1/2" x 2 3/8"	21 1/2"		max 160W R7s 117 mm
	A 93_..65 FLUO	37 x 6	55	14 1/2" x 2 3/8"	21 1/2"	2x36W/827 2G11	
	A 93_..80 HALO	55 x 6	55	21 1/2" x 2 3/8"	21 1/2"		2x max 120W R7s 117 mm
	A 93_..80 FLUO	55 x 6	55	21 1/2" x 2 3/8"	21 1/2"	4x36W/827 2G11	

CODICI COLORI DISPONIBILI / COLOURS CODES AVAILABLE

- 01** Bianco
White
- 21** Foglia oro
Gold leaf
- 35** Alluminio sabbaiato
Sanded aluminium



Flan_

Design_Enzo Panzeri 2007

Lampade da parete/plafone in vetro soffiato bianco satinato e montature in alluminio sabbiato.

Wall/ceiling lamps in sanded aluminium and blown glass.

Decken/Wandleuchten in sandgestrahltem Aluminium mit mundgeblasenem Glas.

Lámpara de pared/plafón en vidrio soplado y montura en aluminio arenado.

Appliques/plafonniers en verre soufflé et monture en aluminium sablé.

Бра/потолочные светильники из белого сатинированного выдувного стекла с арматурой из матового алюминия.





Flan_



Flan_

design_Enzo Panzeri 2007

CE IP40

Energy Label available at www.panzeri.it

220 / 240 V

	CODICE / CODE	CM Ø	H	INCHES Ø	H	FLUO	HALO
Soffitto / Ceiling	P 1235.12	14	9,5	5 ½"	3 ¾"		max 48W G9
	P 1235.25 HALO	26	10	10 ¼"	4"		max 120W R7s 117 mm
	P 1235.25 FLUO	26	10	10 ¼"	4"	2x26W/827 G24 q-3 2x32W/827 GX24 q-3	
	P 1235.45 HALO	46	10	18 ⅞"	4"		max 160W R7s 117 mm
	P 1235.45 FLUO	46	10	18 ⅞"	4"	22W+40W/827 2GX13	

CODICI COLORI DISPONIBILI / COLOURS CODES AVAILABLE

35 Alluminio sabbato
Sanded aluminium



Bollard_

Design_Enzo Panzeri 2006

Lampade da tavolo e da parete in vetro soffiato bianco satinato. Montatura della lampada da tavolo in metallo pieno tornito satinato e verniciato. Montatura delle lampade da parete verniciata bianca.

Table and wall lamps in mat white blown glass. Table lamps fitting in solid turned mat painted metal, wall lamp fitting in white paint finish.

Tisch- und Wandleuchten in mundgeblasenem Glas weiß satiniert. Struktur der Tischleuchte aus massivem, gedrehtem, satiniertem und lackiertem Metall. Struktur der Wandleuchte weiß lackiert.

Lámparas de mesa, de pared en vidrio soplado blanco satinado. Montura de la lámpara de mesa en metal lleno torneado satinado y lacado. Montura de las lámparas de pared lacada blanca.

Lampes de table et appliques en verre soufflé blanc satiné. Monture de la lampe de table en métal plein tourné satiné et verni. Monture des appliques vernie blanc.

Настольные лампы и бра из сатинированного выдувного стекла белого цвета. Арматура настольной лампы выточена из цельного бруска матового, окрашенного металла. Арматура бра белого цвета.







Bollard_

Bollard_	design_Enzo Panzeri 2006	CE IP20 (Table) 			
Energy Label available at www.panzeri.it					
220 / 240 V					
	CODICE / CODE	CM A x B	H	INCHES Ø / A x B H	HALO
Parete / Wall	A 9937.9	20 x 8,5	20	7 7/8" 3 3/8" 7 3/8"	max 60W R7s 78 mm
	A 9937.14	21 x 14	22	8 1/4" 5 1/2" 8 1/2"	max 80W R7s 78 mm
Tavolo / Table	C 9937.35	21 x 26	34	8 1/4" x 10 1/4" 13 3/8"	max 60W E14
	C 9937.65	39 x 49	63	15 3/8" x 19 1/4" 24 3/4"	max 150W E27 dimmer

CODICI COLORI DISPONIBILI / COLOURS CODES AVAILABLE

37 Acciaio
Steel



Decentramento / Offset



M79D
Grigio metallizzato
Metallized grey
Graumetallic
Gris metalizado
Gris métallisé
СЕРЫЙ МЕТАЛЛИК

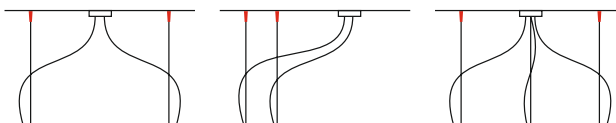

M75D
Grigio metallizzato
Metallized grey
Graumetallic
Gris metalizado
Gris métallisé
СЕРЫЙ МЕТАЛЛИК

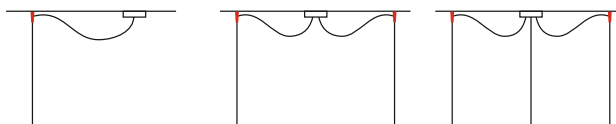

M7533
Grigio metallizzato
Metallized grey
Graumetallic
Gris metalizado
Gris métallisé
СЕРЫЙ МЕТАЛЛИК

Disponibile con 1, 2, 3 fori - 1, 2 or 3 holes available

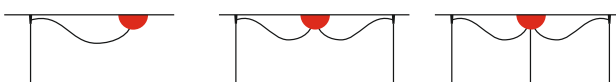

M7533/1

M7533/2

M7533/3

M7532
Nichel
Nickel
Nickel
Níquel
Nickel
НИКЕЛЬ

Disponibile con 1, 2, 3 fori - 1, 2 or 3 holes available

M7532/1

M7532/2

M7532/3



M7901
Bianco
White
Weiß
Blanco
Blanc
БЕЛЫЙ

Disponibile con 1, 2, 3 fori - 1, 2 or 3 holes available

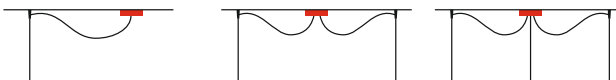

M7901/1

M7901/2

M7901/3

M7933
Grigio metallizzato
Metallized grey
Graumetallic
Gris metalizado
Gris métallisé
СЕРЫЙ МЕТАЛЛИК

Disponibile con 1, 2, 3 fori - 1, 2 or 3 holes available

M7933/1

M7933/2

M7933/3

M7932
Nichel
Nickel
Nickel
Níquel
Nickel
НИКЕЛЬ

Disponibile con 1, 2, 3 fori - 1, 2 or 3 holes available

M7932/1

M7932/2

M7932/3

M7922
Cromo
Chrome
Chrom
Cromo
Chrome
ХРОМ

Disponibile con 1, 2, 3 fori - 1, 2 or 3 holes available

M7922/1

M7922/2

M7922/3

M89_

Barra in bianco o grigio metallizzato
White or metallized grey track
Schiene in weiß oder graumetallic
Barra en blanco o gris metalizado
Barre en blanc ou gris métallisé
Шина, цвет серый металл или белый

01

Bianco
White
Weiß
Blanco
Blanc
БЕЛЫЙ

33

Grigio metallizzato
Metallized grey
Graumetallic
Gris metalizado
Gris métallisé
СЕРЫЙ МЕТАЛЛИК



M8901-42
M8933-42
MAX 3 LIGHTS

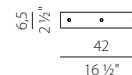

Accessorio per sospensioni con solo cavo elettrico
Detail for electric cable suspensions
Detail für Hängeleuchten mit Stromkabel
Detalle por suspensión con cable eléctrico
Accessoire pour suspension avec fil électrique
Аксессуар для подвеса только на электрический провод



M8901-76
M8933-76
MAX 5 LIGHTS

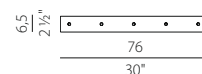

Accessorio per sospensioni con solo cavo elettrico
Detail for electric cable suspensions
Detail für Hängeleuchten mit Stromkabel
Detalle por suspensión con cable eléctrico
Accessoire pour suspension avec fil électrique
Аксессуар для подвеса только на электрический провод

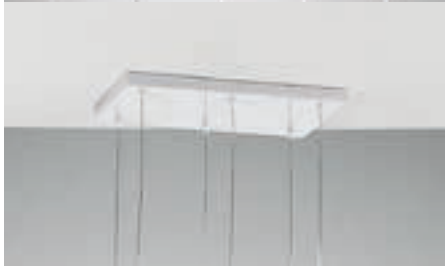

M8901-25
M8933-25
MAX 6 LIGHTS

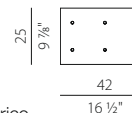

Accessorio per sospensioni con solo cavo elettrico
Detail for electric cable suspensions
Detail für Hängeleuchten mit Stromkabel
Detalle por suspensión con cable eléctrico
Accessoire pour suspension avec fil électrique
Аксессуар для подвеса только на электрический провод

M120_

Barra in bianco o grigio metallizzato con speciali liste in policarbonato copriforo adattabile a svariati modelli del nostro catalogo.

White or metallized grey track with special polycarbonate strips to cover holes. Adjustable to various series of our collections.

Schiene in weiß oder graumetallic mit speziellen Abdeckungsleisten aus Polycarbonat, geeignet für verschiedene Artikel unserer Kollektion.

Barra en blanco o gris metalizado con listas especiales de policarbonato cubre agujeros adaptable a diversos modelos de nuestro catálogo.

Barre en blanc ou gris métallisé avec baguettes spéciales en polycarbonate cache adaptable à différents modèles dans notre catalogue.

Шина, цвет серый металл или белый, со специальными заглушками - пластинами из поликарбоната. Совместима с различными моделями каталога.

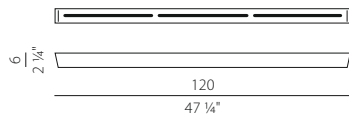

M120 01
M120 33

Da ordinare con accessori CE o CA
To be ordered with CE or CA details
Mit CE oder CA Detail bestellen
De ordenar con accesorios CE o CA
A ordonner avec des accessoires CE ou CA
Заказывать вместе с аксессуарами CE или CA

CE

Accessorio per sospensioni con solo cavo elettrico
Detail for electric cable suspensions
Detail für Hängeleuchten mit Stromkabel
Detalle por suspensión con cable eléctrico
Accessoire pour suspension avec fil électrique
Аксессуар для подвеса только на электрический провод

ARTICOLI ABBINABILI A M120 CON ACCESSORIO CE
ITEMS CAN BE MATCHED TO M120 WITH CE DETAIL
VERFÜGBARE ARTIKEL FÜR M120 MIT CE DETAIL
ARTÍCULOS COMBINABLES CON M120 CON DETALLE CE
ARTICLES COMBINABLES AVEC M120 AVEC ACCESSOIRE CE
МОДЕЛИ СОВМЕСТИМЫЕ С М120 С ИСПОЛЬЗОВАНИЕМ CE

ONE, TWO, BONBON, CANDLE, DOMINO, FLORAL 20, JAZZ, LINE, RING 16, RING INOX 16, TILLY, TOURBILLON 16, TRACK, WAVE, WILLY 16



CA

Accessorio per sospensioni con cavo in acciaio
Detail for stainless steel cable suspensions
Detail für Hängeleuchten mit Stahlseil
Detalle por suspensión con cable de acero
Accessoire pour suspension avec fil en acier
Аксессуар для подвеса с использованием стального троса

ARTICOLI ABBINABILI A M120 CON ACCESSORIO CA
ITEMS CAN BE MATCHED TO M120 WITH CA DETAIL
VERFÜGBARE ARTIKEL FÜR M120 MIT CA DETAIL
ARTÍCULOS COMBINABLES CON M120 CON DETALLE CA
ARTICLES COMBINABLES AVEC M120 AVEC ACCESSOIRE CA
МОДЕЛИ СОВМЕСТИМЫЕ С М120 С ИСПОЛЬЗОВАНИЕМ CA

ALVI, BLOW, BLOW MINI, DELPHINA, FLORAL 40, RING 25, RING 40, RING INOX 25, RING INOX 40, SPYRA 35, TOURBILLON 30, TWISTER 35, WILLY 40

01

Bianco
White
Weiß
Blanco
Blanc
БЕЛЫЙ

33

Grigio metallizzato
Metallized grey
Graumetallic
Gris metalizado
Gris métallisé
СЕРЫЙ МЕТАЛЛИК

Veneziani_

Vetreteria_

Arte vetraria veneziana, maestria e tecnica lombarda si coniugano per creare queste nuove opere artigianali, ma nel contempo attuali e tecnicamente avanzate.

Venetian glassworking art combines lombard mastery and technical skill to create this new artisanal product which, at the same time, is both contemporary in look and technically advanced.

Die verbindung venezianischer glaskunst mit lombardischer fachkenntnis hat die kreation dieser neuen werke ermöglicht, die handwerkliche qualität mit zeitgenössischem stil und technischem fortschritt vereinen.

Vidrieria de arte veneziana, maestria y tecnica lombarda se conjugan para crear estas nuevas operas artesanal es al mismo tiempo actual y tecnicamente avanzadas.

Verrerie venitienne, maitrise et technicite lombarde se conjuguent pour creer ces nouvelles œuvres artisanales, mais au meme temps actuelles et techniquement avancees.

Искусство стекольщиков Венеции, мастерство и технологичность Ломбардии объединились, чтобы создать эти светильники: изделия ремесленные, но в то же время актуальные и использующие передовую технологию.

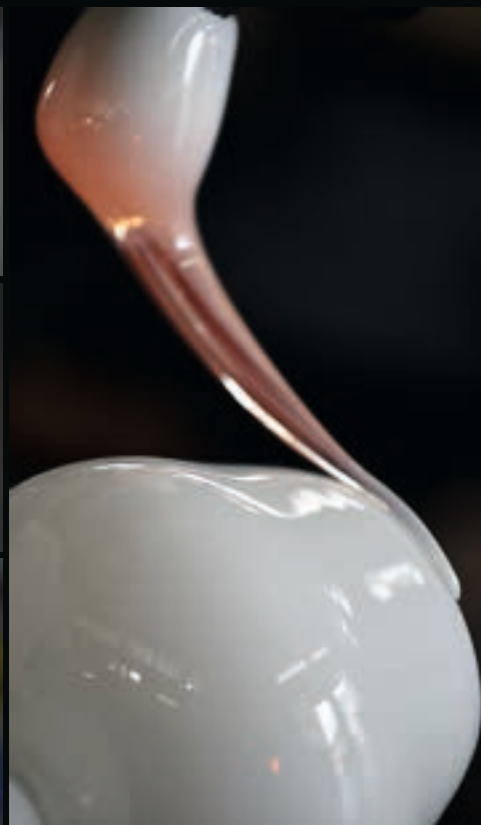



Tate_





Tate_



BIANCO SATINATO / WHITE MAT



NERO SATINATO / BLACK MAT



Uffizi_





Brera_





Moma_





Prado_





Hermitage_



Y-HER-8L + YM10





Puškin_





D'Orsay_



Y-DOR-5L + YM10



Louvre_





Guggenheim_





Metropolitan_





Tate_	2009						CE IP20
							Energy Label available at www.panzeri.it
		CODICE / CODE	CM Ø / A x B	H	INCHES Ø / A x B	H	HALO
	Sospensione / Suspension	Y - TAT - 6L	90	75	35 1/2"	29 1/2"	6 x max 60W G9
		Y - TAT - 8L	100	75	39 3/8"	29 1/2"	8 x max 60W G9
	Parete / Wall	Y - TAT - 2A	40 x 25	30	15 3/4" x 9 3/4"	11 3/4"	2 x max 60W G9
	YM10						Fusciacca bianca / White Cloth cover
	YM12						Gancio per appendimento / Ceiling hook

CODICI COLORI DISPONIBILI / COLOURS CODES AVAILABLE

Cromo Chrome	BIANCO WHITE	NERO BLACK	BIANCO SATINATO WHITE MAT	NERO SATINATO BLACK MAT	YM10	YM12
						

Uffizi_	2009						CE IP20
							Energy Label available at www.panzeri.it
		CODICE / CODE	CM Ø / A x B	H	INCHES Ø / A x B	H	HALO
	Sospensione / Suspension	Y - UFF - 6L	95	75	37 1/2"	29 1/2"	6 x max 60W G9
		Y - UFF - 8L	105	75	41 3/8"	29 1/2"	8 x max 60W G9
	Parete / Wall	Y - UFF - 2A	40 x 25	35	15 3/4" x 9 3/4"	13 3/4"	2 x max 60W G9
	YM10						Fusciacca bianca / White Cloth cover
	YM12						Gancio per appendimento / Ceiling hook

CODICI COLORI DISPONIBILI / COLOURS CODES AVAILABLE

Cromo Chrome	BIANCO WHITE	NERO BLACK	ROSSO RED	PAGLIESCO STRAW YELLOW	VIOLA VIOLET	YM10	YM12
							

Brera_	2009						CE IP20
							Energy Label available at www.panzeri.it
		CODICE / CODE	CM Ø / A x B	H	INCHES Ø / A x B	H	HALO
	Sospensione / Suspension	Y - BRE - 6L	95	75	37 1/2"	29 1/2"	6 x max 60W G9
		Y - BRE - 8L	105	75	41 3/8"	29 1/2"	8 x max 60W G9
	Parete / Wall	Y - BRE - 2A	40 x 25	35	15 3/4" x 9 3/4"	13 3/4"	2 x max 60W G9
	YM10						Fusciacca bianca / White Cloth cover
	YM12						Gancio per appendimento / Ceiling hook

CODICI COLORI DISPONIBILI / COLOURS CODES AVAILABLE

Cromo Chrome	BIANCO WHITE	NERO BLACK	ROSSO RED	PAGLIESCO STRAW YELLOW	VIOLA VIOLET	YM10	YM12
							

Moma_

2009

CE IP20



						Energy Label available at www.panzeri.it
		CODICE / CODE	CM Ø / A x B	H	INCHES Ø / A x B H	HALO
Sospensione / Suspension	Y - MOM - 6L	75	80	29 1/2"	31 1/2"	6 x max 60W G9
	Y - MOM - 8L	75	80	29 1/2"	31 1/2"	8 x max 60W G9
Parete / Wall	Y - MOM - 2A	40 x 25	35	15 3/4" x 9 3/4"	13 3/4"	2 x max 60W G9
	Y - MOM - 3A	40 x 25	40	15 3/4" x 9 3/4"	15 3/4"	3 x max 60W G9
YM10						Fusciacca bianca / White Cloth cover
YM12						Gancio per appendimento / Ceiling hook

CODICI COLORI DISPONIBILI / COLOURS CODES AVAILABLE

Cromo Chrome	BIANCO WHITE	NERO BLACK	BIANCO SATINATO WHITE MAT	NERO SATINATO BLACK MAT	YM10	YM12

Prado_

Design Silvia Poma 2011

CE IP20



						Energy Label available at www.panzeri.it
		CODICE / CODE	CM Ø / A x B	H	INCHES Ø / A x B H	HALO
Sospensione / Suspension	Y - PRA - 6L	90	100	35 1/2"	39 3/8"	6 x max 60W G9
	Y - PRA - 10L	90	100	35 1/2"	39 3/8"	10 x max 60W G9
Parete / Wall	Y - PRA - 3A	40 x 25	40	15 3/4" x 9 3/4"	15 3/4"	3 x max 60W G9
YM10						Fusciacca bianca / White Cloth cover
YM12						Gancio per appendimento / Ceiling hook

CODICI COLORI DISPONIBILI / COLOURS CODES AVAILABLE

Cromo Chrome	CRISTALLO CRYSTAL	PAGLIESCO STRAW YELLOW	VIOLA VIOLET	YM10	YM12

Hermitage_

2009



CE IP20





						Energy Label available at www.panzeri.it
		CODICE / CODE	CM Ø / A x B	H	INCHES Ø / A x B H	HALO
Sospensione / Suspension	Y - HER - 6L	85	75	33 1/2"	29 1/2"	6 x max 60W G9
	Y - HER - 8L	100	75	39 3/8"	29 1/2"	8 x max 60W G9
Parete / Wall	Y - HER - 2A	40 x 25	45	15 3/4" x 9 3/4"	17 3/4"	2 x max 60W G9
YM10						Fusciacca bianca / White Cloth cover
YM12						Gancio per appendimento / Ceiling hook



CODICI COLORI DISPONIBILI / COLOURS CODES AVAILABLE

Cromo Chrome	BIANCO WHITE	NERO BLACK	ROSSO RED	CRISTALLO CRYSTAL	PAGLIESCO STRAW-YELLOW	VIOLA VIOLET	YM10	YM12

Puškin_	2009						CE IP20 
							Energy Label available at www.panzeri.it
		CODICE / CODE	CM Ø / A x B	H	INCHES Ø / A x B	H	HALO
	Sospensione / Suspension	Y - PUS - 6L	85	75	33 1/2"	29 1/2"	6 x max 60W G9
		Y - PUS - 8L	100	75	39 3/8"	29 1/2"	8 x max 60W G9
	Parete / Wall	Y - PUS - 2A	40 x 25	40	15 3/4" x 9 3/4"	15 3/4"	2 x max 60W G9
		YM10	Fusciacca bianca / White Cloth cover				
	YM12	Gancio per appendimento / Ceiling hook					



CODICI COLORI DISPONIBILI / COLOURS CODES AVAILABLE

Cromo Chrome	BIANCO WHITE	NERO BLACK	ROSSO RED	CRISTALLO CRYSTAL	PAGLIESCO STRAW-YELLOW	VIOLA VIOLET	YM10	YM12
								

D'Orsay_	2009						CE IP20 
							Energy Label available at www.panzeri.it
		CODICE / CODE	CM Ø / A x B	H	INCHES Ø / A x B	H	HALO
	Sospensione / Suspension	Y - DOR - 3L	60	75	23 1/2"	29 1/2"	3 x max 60W G9
		Y - DOR - 5L	60	75	23 1/2"	29 1/2"	5 x max 60W G9
		Y - DOR - 8L	85	75	33 1/2"	29 1/2"	8 x max 60W G9
	Parete / Wall	Y - DOR - 2A	40 x 25	30	15 3/4" x 9 3/4"	11 3/4"	2 x max 60W G9
	YM10	Fusciacca bianca / White Cloth cover					
	YM12	Gancio per appendimento / Ceiling hook					

CODICI COLORI DISPONIBILI / COLOURS CODES AVAILABLE

Cromo Chrome	BIANCO WHITE	NERO BLACK	ROSSO RED	CRISTALLO CRYSTAL	PAGLIESCO STRAW-YELLOW	VIOLA VIOLET	YM10	YM12
								

Louvre_	2009						CE IP20 
							Energy Label available at www.panzeri.it
		CODICE / CODE	CM Ø / A x B	H	INCHES Ø / A x B	H	HALO
	Sospensione / Suspension	Y - LOU - 3L	60	75	23 1/2"	29 1/2"	3 x max 60W G9
		Y - LOU - 5L	60	75	23 1/2"	29 1/2"	5 x max 60W G9
		Y - LOU - 8L	85	75	33 1/2"	29 1/2"	8 x max 60W G9
	Parete / Wall	Y - LOU - 2A	40 x 25	30	15 3/4" x 9 3/4"	11 3/4"	2 x max 60W G9
	YM10	Fusciacca bianca / White Cloth cover					
	YM12	Gancio per appendimento / Ceiling hook					

CODICI COLORI DISPONIBILI / COLOURS CODES AVAILABLE

Cromo Chrome	BIANCO WHITE	NERO BLACK	ROSSO RED	CRISTALLO CRYSTAL	PAGLIESCO STRAW-YELLOW	VIOLA VIOLET	YM10	YM12
								

Guggenheim_

Design Silvia Poma 2009

CE IP20 



						Energy Label available at www.panzeri.it
	CODICE / CODE	CM Ø / A x B	H	INCHES Ø / A x B	H	HALO
Sospensione / Suspension	Y - GUG - 6L	80	75	31 ½"	29 ½"	6 x max 60W G9
	Y - GUG - 8L	80	75	31 ½"	29 ½"	8 x max 60W G9
Parete / Wall	Y - GUG - 2A	40 x 35	35	15 ¾" x 13 ¾"	13 ¾"	2 x max 60W G9
	Y - GUG - 3A	40 x 35	45	15 ¾" x 13 ¾"	17 ¾"	3 x max 60W G9
YM12						Gancio per appendimento / Ceiling hook

CODICI COLORI DISPONIBILI / COLOURS CODES AVAILABLE

Cromo
Chrome

BIANCO / NERO
WHITE / BLACK

YM12



Metropolitan_

Design Silvia Poma 2011

CE IP20 



						Energy Label available at www.panzeri.it
	CODICE / CODE	CM Ø	H	INCHES Ø	H	HALO
Sospensione / Suspension	Y - MET - 15L	130	110	51 ¼" x	43 ¼"	15 x max 60W G9
YM12						Gancio per appendimento / Ceiling hook

CODICI COLORI DISPONIBILI / COLOURS CODES AVAILABLE

Cromo
Chrome

BIANCO
WHITE

NERO
BLACK

BIANCO SATINATO
WHITE MAT

NERO SATINATO
BLACK MAT

VIOLA
VIOLET

YM12



Electric Options_

ELECTRIC OPTIONS

Componenti elettrici / Electrical components



XM2

LAMPHOLDER + TERMINAL BLOCK

MAX 50W GU5,3 12V 
 CE IP20  

XM3

LAMPHOLDER + TERMINAL BLOCK

MAX 50W GU10 
 OR GU10 FLUO 
 OR LED LAMP GU10 
 CE IP20  

XM3.1

LAMPHOLDER + TERMINAL BLOCK

MAX 35W GU10 
 OR GU10 FLUO 
 OR LED LAMP GU10 
 CE IP20  

XM3L

LAMPHOLDER

MAX 75W GU10 
 OR LED LAMP GU10 
 CE IP20  

LED Corrente costante / Constant current

XM5/350N

LED 6,7W 350mA 19,2V 3000K 40° Ra 80 600lm
 CE 

TECHNICAL INFORMATION	WIRING DIAGRAM 4
PAG. 440	PAG. 440

XM5/350 HO

LED 11,2W 350mA 32V 3000K 40° Ra 80 1230lm
 CE 

TECHNICAL INFORMATION	WIRING DIAGRAM 4
PAG. 440	PAG. 440

XM5/350N
 Ø 50mm H 66mm
 Ø 2" x 2 3/8"



XM5/350 HO
 Ø 50mm H 86mm
 Ø 2" x 3 2/5"



ELECTRIC OPTIONS

LED tensione costante / Constant voltage

XM2033-50 LED3000

Modulo / module 500 mm 28LED
8,5W 3000K Ra 80 24V 1075lm
Frazionabile ogni / Divisible every 125mm
2150 lm/mt - 56 led/mt
CE 

TECHNICAL INFORMATION	WIRING DIAGRAM 1
PAG. 439	PAG. 439

500 x 14 mm
19 3/8" x 5/8"



XM2033-12,5 LED3000

Modulo / module 125 mm 7LED
2,1W 3000K Ra 80 24V 268lm
2150 lm/mt - 56 led/mt
CE 

TECHNICAL INFORMATION	WIRING DIAGRAM 1
PAG. 439	PAG. 439

125 x 14 mm
5" x 5/8"



XM1ROW/N/5MT

XM1ROW/N/5MT/4000K

XM1ROW/IP65/N/5MT

XM1ROW/IP65/N/5MT/4000K

STRIP ROLL 1 ROW 5 MT 3000K / 4000K Ra 80 24V
Frazionabile ogni / Divisible every 100 mm
5 x 60 led/mt - 5 x 14,4 W/mt
5 x 1080 lm/mt - 18lm/led
CE 

TECHNICAL INFORMATION	WIRING DIAGRAM 2
PAG. 439	PAG. 439

5000 x 10 mm
197" x 3/8"



XM2ROW/5MT

XM2ROW/5MT/4000K

STRIP ROLL 2 ROW 5 MT 3000K / 4000K 24V
Frazionabile ogni / Divisible every 100 mm
5 x 120 led/mt - 5 x 28 W/mt
5 x 1920 lm/mt - 16lm/led
CE 

TECHNICAL INFORMATION	WIRING DIAGRAM 2
PAG. 439	PAG. 439

5000 x 20 mm
197" x 3/8"



XM1ROW HO/3MT

STRIP ROLL 1 ROW 3 MT 3000K Ra 80 24V
Frazionabile ogni / Divisible every 35 mm
3 x 168 led/mt - 3 x 35 W/mt
3 x 3000 lm/mt - 18lm/led
CE 

TECHNICAL INFORMATION	WIRING DIAGRAM 3
PAG. 440	PAG. 440

3000 x 8 mm
197" x 3/8"



XM1ROW HE/5MT

XM1ROW HE/5MT/4000K

STRIP ROLL 1 ROW 5 MT 3000K / 4000K Ra 80 24V
Frazionabile ogni / Divisible every 80 mm
5 x 75 led/mt - 5 x 25 W/mt
5 x 1950 lm/mt - 26lm/led
CE 

TECHNICAL INFORMATION	WIRING DIAGRAM 2
PAG. 439	PAG. 439

5000 x 10 mm
197" x 3/8"



Accessori / Accessoires

XM1ROW/C

CONNETTORE PER ROLLINE 1ROW, 1ROW HE
CONNECTOR STRIP-TO-STRIP 1 ROW, 1ROW HE



XM1ROW/S

CAVI ALIMENTAZIONE PER ROLLINE 1ROW, 1ROW HE
CONNECTOR STRIP-TO-WIRE 1 ROW, 1ROW HE



XM1ROW HO/C

CONNETTORE PER ROLLINE 1ROW HO
CONNECTOR STRIP-TO-STRIP 1ROW HO



XM1ROW HO/S

CAVI ALIMENTAZIONE PER ROLLINE 1ROW HO
CONNECTOR STRIP-TO-WIRE 1ROW HO



XM1ROW HO/A

CONNETTORE AD ANGOLO PER ROLLINE 1ROW HO
ANGLE CONNECTOR TO STRIP 1ROW HO



ELECTRIC OPTIONS

LED lamp AR111 / Low Voltage + Trasformatore / Transformer

*Con l'utilizzo del trasformatore XM50/12 garantiamo il corretto funzionamento della lampadina AR111 (XM5/111).
 *With the use of the transformer XM50/12 we guarantee the correct operation of the Led Lamp AR111 (XM5/111).

XM5/111

LED 15W G53 3000K 40° Ra80 12VAC/DC 860lm NOT DIMMABLE
 CE

***XM50/12**

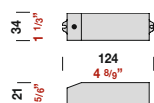

V in 230-240VAC
 V out 12VAC
 W 1-50 (LED)
 CE SELV



Trasformatore / Transformer

XM10512

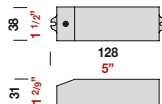

V in 220-240V
 V out 12VAC
 W 35-105
 CE SELV

LED driver corrente costante / Constant current

XM6/350/12

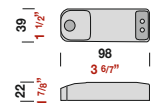

V in 220-240VAC
 V out 2-34V DC
 I out 350mA DC
 W 12
 λ 0,8
 CE SELV

LED Driver Multi-Corrente / Multi-dim (1-10V-DALI-PUSH DIM)

XM6-42 D/P MULTI

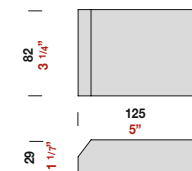

V in 220-240VAC
 V out 6-48V DC
 I out 350-1050Ma DC
 W 16,8-42
 λ ≥ 0,9
 CE SELV 1...10 V PUSH DIM DALI

ELECTRIC OPTIONS

LED Driver tensione costante / Constant voltage

XM150/24

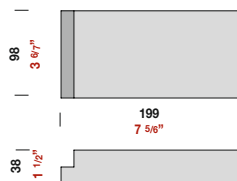

V in 200-240VAC
 V out 24V DC
 I out 6,5A DC
 W 150
 C€ SELV

XM75/24

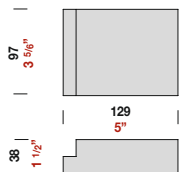

V in 100-240VAC
 V out 24V DC
 I out 3,2A DC
 W 75
 C€ SELV

XM30/24E

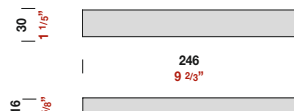

V in 220-240VAC
 V out 24V DC
 I out 1,25A DC
 W 30
 $\lambda \geq 0,9$
 C€ SELV

XM60/24EN

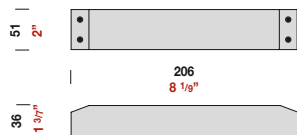

V in 120-240VAC
 V out 24V DC
 I out 2,5A DC
 W 60
 $\lambda \geq 0,95$
 C€ SELV

XM150/24EN

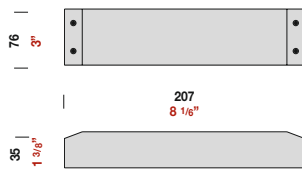

V in 120-240VAC
 V out 24V DC
 I out 6,25A DC
 W 150
 $\lambda \geq 0,95$
 C€ SELV

XM320/24

(solo su richiesta/only on request)

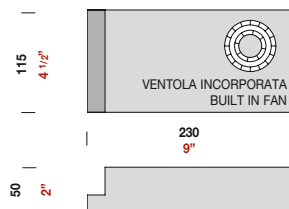

V in 100-240VAC
 V out 24V DC
 I out 13A DC
 W 320
 $\lambda > 0,95$
 C€ SELV

ELECTRIC OPTIONS

LED control system

Dispositivi per la dimmerazione di moduli LED a 12-24VDC. Utilizzabili con alimentatore standard (non dimmerabile). E' possibile applicarli anche in impianti esistenti senza sostituire gli alimentatori in essere.

Dimming devices for LED modules (12-24VDC). Can be used with standard drivers (not dimmable). It's also possible to use the device in existing lighting systems without replacing the already installed LED drivers.

XM13/24D

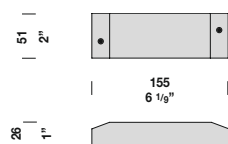

DISPOSITIVO DIMMERABILE
MODALITÀ DI DIMMERAZIONE
DIMMING DEVICE
DIMMING MODE
1-10V, PUSH DIM, DALI
V in 12-24VDC
I out 12A (MAX)DC
W 288(24V)/144(12V)

TECHNICAL INFORMATION	WIRING DIAGRAM 6
PAG. 441	PAG. 441

CE SELV **1...10 V** PUSH DIM DALI

XM13/24A

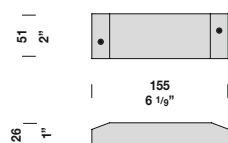

AMPLIFICATORE PER DISPOSITIVO DIMMERAZIONE
PVM AMPLIFIER FOR DIMMABLE DEVICE
SLAVE
V in 12-24VDC
I out 12A (MAX)DC
W 288(24V)/144(12V)

TECHNICAL INFORMATION	WIRING DIAGRAM 6
PAG. 441	PAG. 441

CE SELV

Matrice di compatibilità LED e Profili - LED/driver matrix

	XM5/350N	XM5/350 HO	XM2033-50 LED 3000	XM2033-12,5 LED 3000	XM1ROW/N/5MT	XM1ROW HO/3MT	XM1ROW HE/5MT	XM2ROW/5MT
constant current								
XM6/350/12	1	1						
XM6-42 D/P MULTI	min. 1- max. 2	1						
constant voltage								
XM150/24			150W	150W	150W	150W	150W	150W
XM75/24			75W	75W	75W	75W	75W	75W
XM150/24E			150W	150W	150W	150W	150W	150W
XM60/24E			60W	60W	60W	60W	60W	60W
XM30/24E			30W	30W	30W	30W	30W	30W
XM320/24*			320W	320W	320W	320W	320W	320W
LED control systems								
XM13/24D			288W	288W	288W	288W	288W	288W
XM13/24A			288W	288W	288W	288W	288W	288W

* only on request

Matrice di compatibilità LED e PROFILI - LED/PROFILES Matrix						
	XM2033-50 LED 3000	XM2033-12,5 LED 3000	XM1ROW HE /5MT	XM1ROW/N/5MT	XM1ROW HO /3MT	XM2ROW/5MT
	2150 lm/mt	2150 lm/mt	1950 lm/mt	1080 lm/mt	3000 lm/mt	1920 lm/mt
XG2033			*	*		*
XP2033			*	*		*
XG2034			*	*		*
XG2036						
XP2037						
XG2044						

* only without reflector

TECHNICAL INFORMATION

APPARECCHI CON LED A TENSIONE COSTANTE 24V DC

Le nostre strip LED sono state studiate per essere installate all'interno dei nostri prodotti, pertanto se installate al di fuori dei nostri apparecchi è necessario dissipare in modo adeguato. Il collegamento tra i vari apparecchi/LED deve essere effettuato in parallelo. Si deve calcolare la potenza complessiva dei LED e aggiungere almeno 10%. Di conseguenza procedere nella scelta dell'alimentatore. E' necessario considerare la distanza tra alimentatori e apparecchi/LED per limitare possibili cadute di tensione. Segue la tabella 1 che indica la lunghezza/ sezione del cavo e la potenza con alimentazione a 24V DC. Viene indicata la distanza massima tra alimentatore e apparecchi/LED.

FIXTURES USING LEDS WITH A CONSTANT VOLTAGE OF 24V DC

Our LED strips are designed to be installed in our products so if installed elsewhere please consider thermal management by using proper heatsinks. The connection between the various fixtures / LEDs must be carried out in parallel. The total power of the LEDs must be calculated (+ at least 10%) in order to choose the correct power supply. The distance between power supplies and fixtures / LED must be considered to limit possible voltage drop. Table 1 (below) indicates the length / section of the cable and the output (W) using a 24V DC power supply. It shows the maximum distance between the power supply and the fixture/LED.

TABELLA 1			
W	1 mm ²	1,5 mm ²	2,5 mm ²
10	56 mt	85 mt	141 mt
20	28 mt	42 mt	71 mt
30	19 mt	28 mt	47 mt
40	14 mt	21 mt	35 mt
50	11 mt	17 mt	28 mt
60	9 mt	14 mt	24 mt
70	8 mt	12 mt	20 mt
80	7 mt	11 mt	18 mt
90	6 mt	9 mt	16 mt
100	6 mt	8 mt	14 mt
110	5 mt	8 mt	13 mt
120	5 mt	7 mt	12 mt
130	4 mt	7 mt	11 mt
140	4 mt	6 mt	10 mt
150	4 mt	6 mt	9 mt

WIRING DIAGRAM N°1

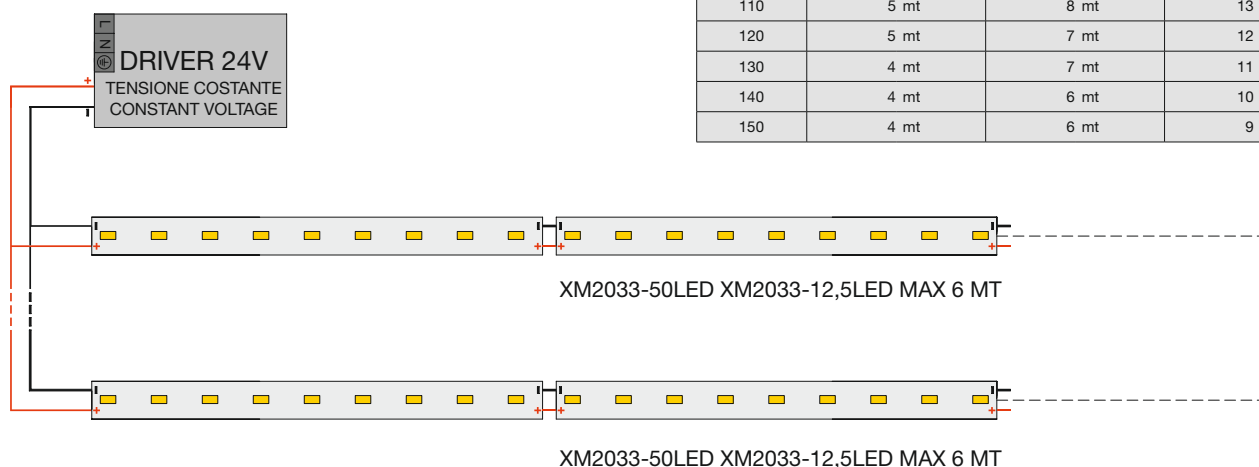

WIRING DIAGRAM N°2

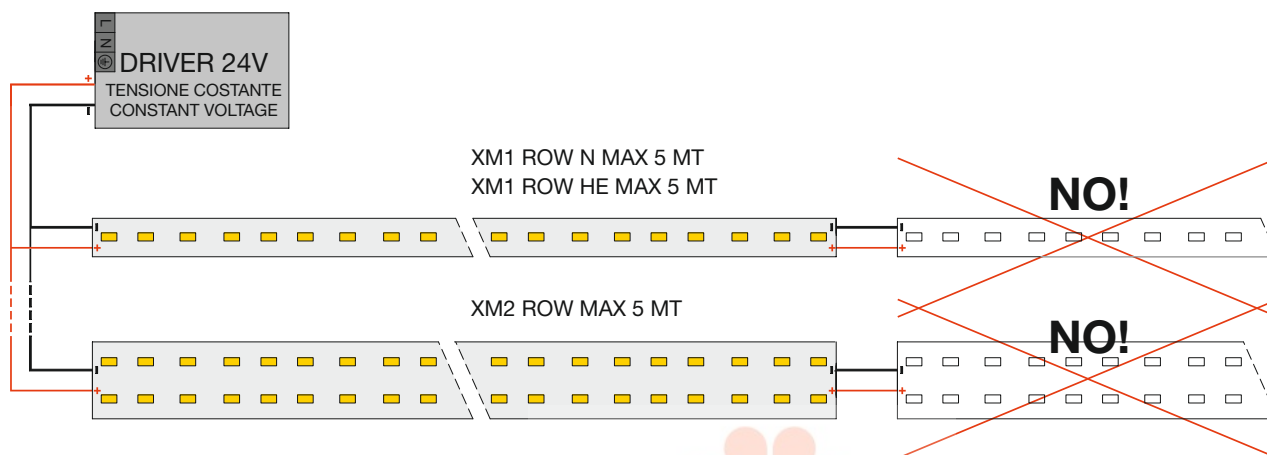

TECHNICAL INFORMATION

WIRING DIAGRAM N. 3

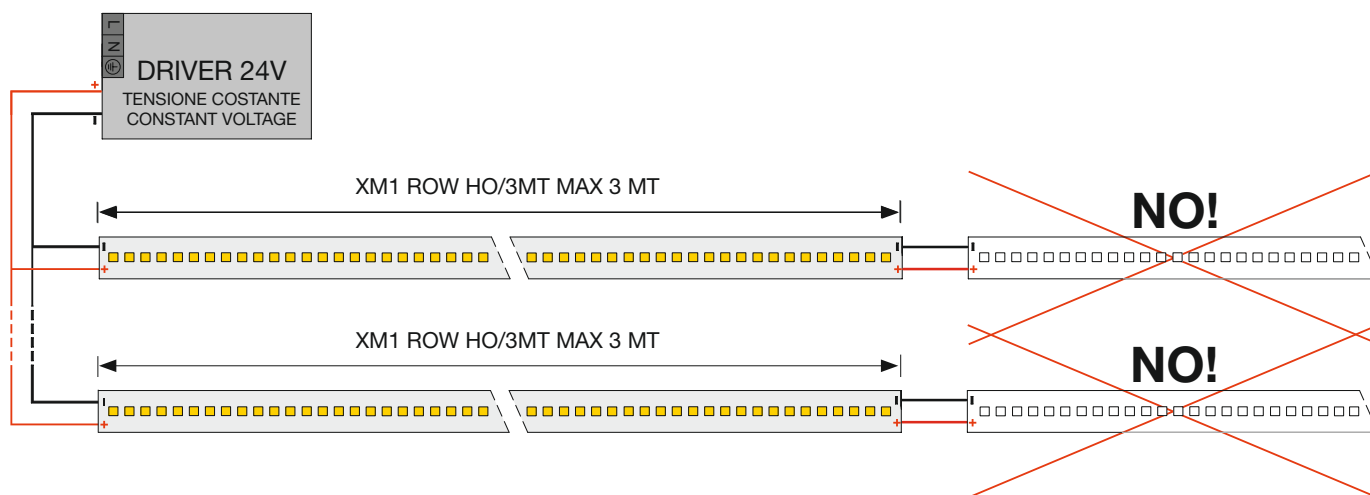

APPARECCHI CON LED A CORRENTE COSTANTE 350mA

Il collegamento tra i vari apparecchi/led deve essere effettuato in serie. Il numero di LED per alimentatore dipende dalla potenza e dalla tensione che l'alimentatore rende disponibile. Nonostante l'utilizzo di correnti molto basse è opportuno considerare la distanza tra alimentatori e apparecchi/LED. Segue la tabella 2 che indica la lunghezza/sezione del cavo con alimentazione a corrente costante. Viene indicata la distanza massima tra alimentatore e apparecchi/LED.

FIXTURES USING LEDS WITH A CONSTANT CURRENT OF 350mA

The connection between the various fixtures / LEDs must be carried out in series. The number of LEDs per power supply unit depends on the available power and voltage of the unit. Notwithstanding the use of very low currents, it is advisable to take into consideration the distance between ballasts and fixtures / LEDs. Table 2 (below) indicates the length / section of the cable using a constant current supply. It shows the maximum distance between the power supply and the fixture/LED.

TABELLA 2

Sezione	1 mm ²	1,5 mm ²	2,5 mm ²
Lunghezza	20 mt	30 mt	50 mt

WIRING DIAGRAM N°4

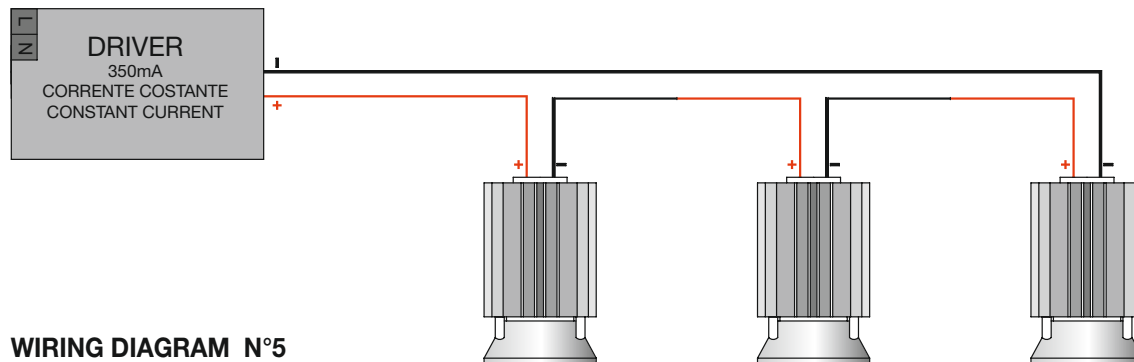

WIRING DIAGRAM N°5

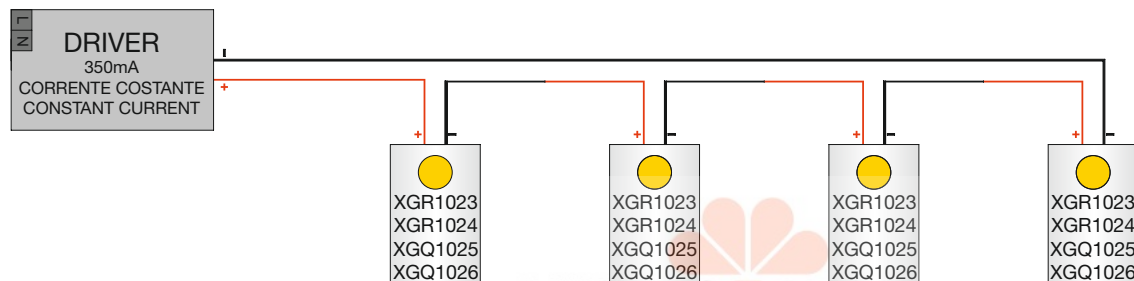

TECHNICAL INFORMATION

WIRING DIAGRAM N°6

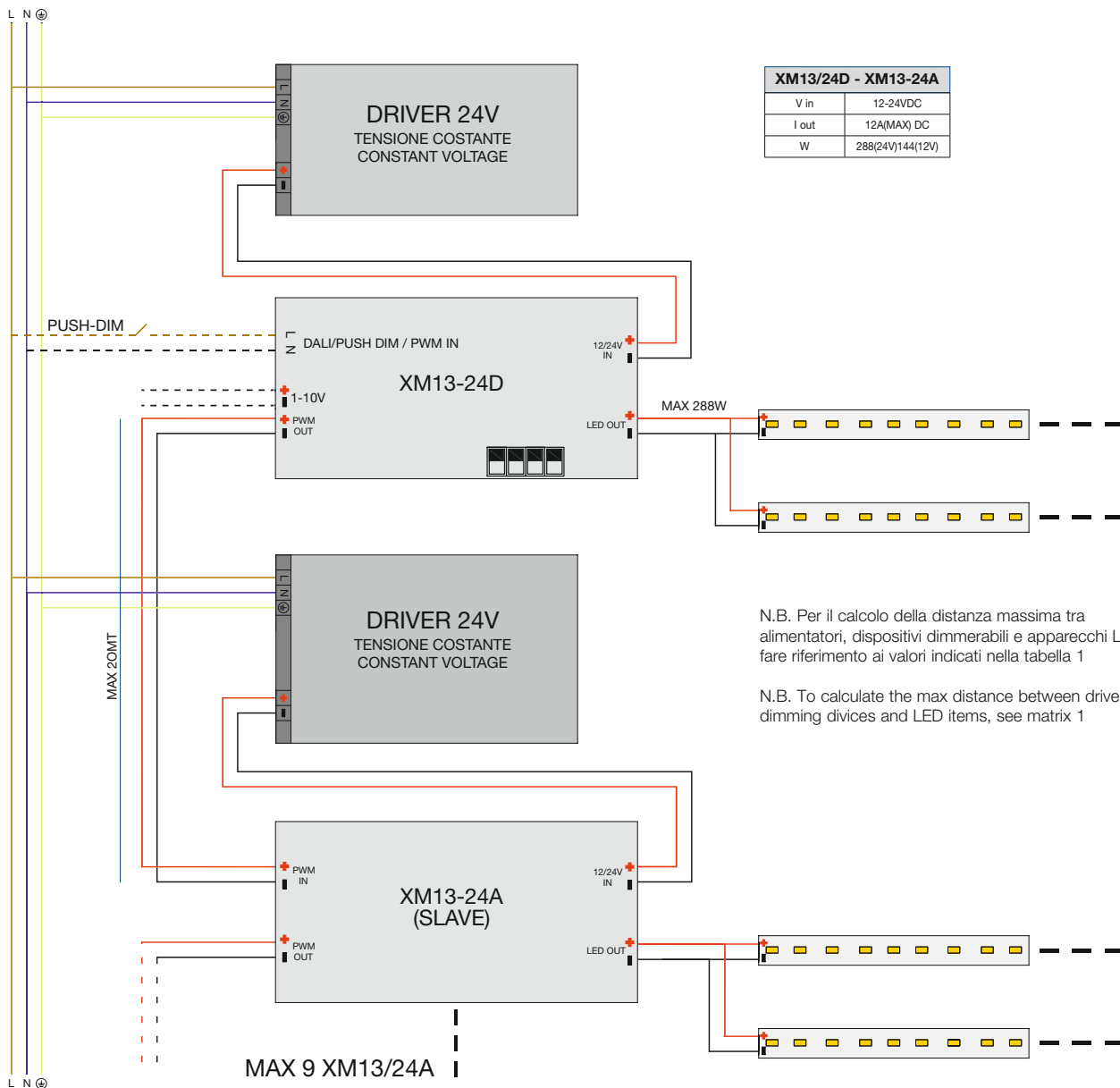

FONDAMENTI DI ILLUMINOTECNICA / LIGHTING BASICS

FLUSSO LUMINOSO Φ

Unità di misura: Lumen (lm)

Per flusso luminoso si intende l'intera potenza irradiata dalla sorgente luce che viene valutata con la sensibilità spettrale dell'occhio. Il flusso luminoso è una grandezza molto utile per confrontare le lampade tradizionali con i LED.

LUMINOUS FLUX Φ

Unit: Lumen (lm)

Luminous flux means the total power radiated by a light source, which is evaluated considering the spectral sensitivity of the eye. The luminous flux is a measurement very useful when comparing traditional lamps with LEDs.

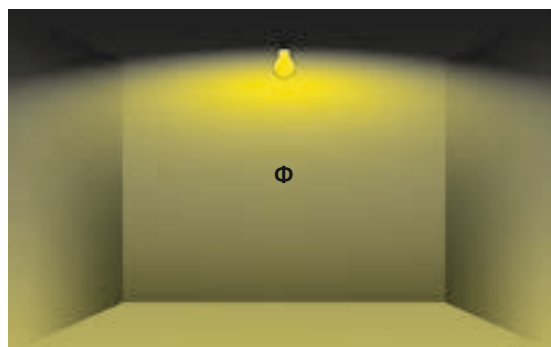

INTENSITÀ LUMINOSA I

Unità di misura: Candela (cd)

Una sorgente luminosa irradia il suo flusso luminoso generalmente in diverse direzioni con diversa intensità. L'intensità della luce irradiata in una determinata direzione viene definita intensità luminosa.

LUMINOUS INTENSITY I

Unit: candela (cd)

A light source emits its luminous flux usually in different directions and at different intensities. The intensity of light radiated in a given direction is defined as light intensity.

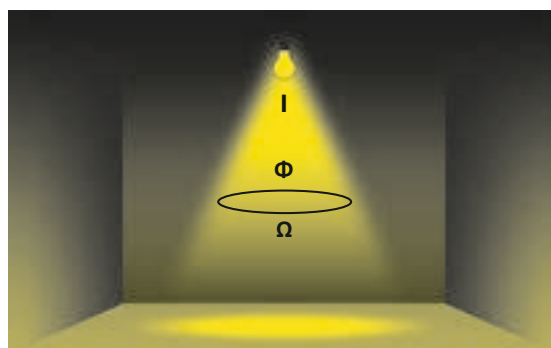

ILLUMINAMENTO E

Unità di misura: Lux (lx)

L'illuminamento è dato dal rapporto tra il flusso luminoso irradiato e la superficie illuminata. L'illuminamento prodotto da un flusso luminoso di 1 lm che cade in modo uniforme su una superficie di 1 mq è pari a 1 lx.

ILLUMINANCE E

Unit: Lux (lx)

Illuminance is the ratio of the luminous flux and the illuminated surface. The illumination produced by a luminous flux of 1 lm that falls evenly on a surface of 1 square meter is equal to 1 lx.

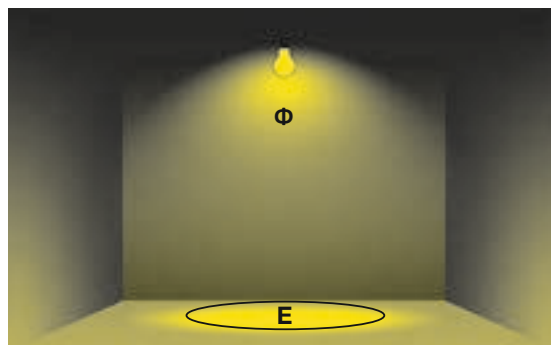

LUMINANZA L

Unità di misura: Candela per metro quadrato [cd/m²]

La luminanza L di una sorgente di luce o di una superficie illuminata è determinante per la sensazione di luce percepita.

LUMINANCE L

Unit: Candela per square meter [cd/m²]

The luminance L of a light source or an illuminated surface indicates how much luminous power will be detected by an eye looking at the surface from a particular angle of view.

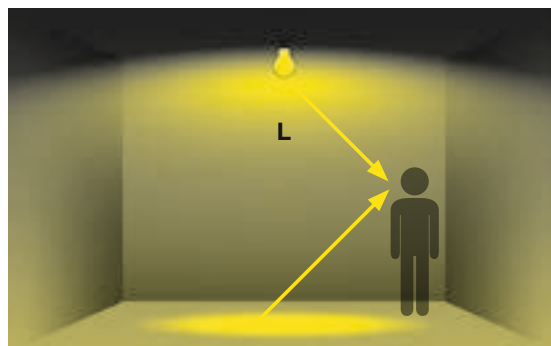

FONDAMENTI DI ILLUMINOTECNICA / LIGHTING BASICS

L'EFFICIENZA LUMINOSA

Unità di misura: Lumen per Watt (lm/w)

L'efficienza luminosa indica il rendimento di una lampada.

Viene espressa dal rapporto fra il flusso luminoso prodotto in lumen e la potenza applicata in watt.

LUMINOUS EFFICACY

Unit: lumens per watt (lm/w)

Luminous efficacy indicates the efficiency of a lamp.

It is the ratio between the luminous flux in lumens produced and the applied power in watts.

TEMPERATURA DI COLORE

Unità di misura: Kelvin (K)

Temperatura di colore indica la tonalità della luce. Più è alto il valore e più fredda è la tonalità della luce

3000K - tonalità calda

4000K - tonalità neutra

5500K - tonalità diurna

COLOUR TEMPERATURE

Unit: Kelvin (K)

Colour temperature indicates a light's tonality: the higher the value, the colder the tone of the light

3000K - warm tone

4000K - neutral tone

5500K - daylight tone

INDICE DI RESA CROMATICA

Ra oppure in inglese Color Rendering Index (CRI)

Si indica come resa cromatica la qualità della riproduzione dei colori sotto una certa illuminazione.

L'indice massimo di 100 rappresenta la resa cromatica ideale.

COLOR RENDERING INDEX

Ra or Color Rendering Index (CRI)

Ra is a quantitative measure of the ability of a light source to reproduce the colors of various objects faithfully in comparison with an ideal or natural light source.

The Ra maximum value 100 equals ideal color rendering.

MARCHI / MARKS

CE Prodotto conforme alle norme di sicurezza e alle direttive europee vigenti.
Product complying with safety rules and EU directives
Das Produkt entspricht den gültigen Sicherheitsvorschriften und EU-Richtlinien
Produit conforme aux règles de sécurité et aux règlements de l'union européenne
Producto conforme a la norma de seguridad y a las directivas europeas
Продукт отвечает требованиям безопасности и директивам ЕС

□ **Apparecchio in classe II**
Apparecchio nel quale la protezione contro la scossa elettrica non si basa unicamente sull'isolamento fondamentale, ma anche sulle misure supplementari di sicurezza costituite dal doppio isolamento o dall'isolamento rinforzato. Queste misure non comportano dispositivi per la messa a terra e non dipendono dalle condizioni di installazione.
Class II Fixture
A fixture for which protection against an electric shock does not rely only on basic insulation but also offers further safety measures, such as double insulation or reinforced insulation. These measures do not require grounding devices and are not dependent upon installation conditions.
Leuchten der Schutzklasse II
Die Schutzvorrichtungen gegen Stromschläge bei diesem Apparat basieren nicht lediglich auf der grundlegenden Isolierung, sondern werden durch eine verdoppelte oder verstärkte Isolierung wesentlich erhöht.
Aufgrund dieser Maßnahmen benötigen Leuchten der Schutzklasse II keine Vorrichtung für die Erdung und sind unabhängig von den Einbaubedingungen.
Aparatos de clase II
Aparatos en los que la protección contra descargas eléctricas no se basa sólo en lo fundamental, sino también en las medidas de seguridad adicionales, tales como el doble aislamiento o aislamiento reforzado.
Estas medidas no incluyen los dispositivos para poner en el suelo y no depende de las condiciones de instalación.
Luminaire classe II
Appareil dans lequel la protection contre les chocs électriques ne repose pas seulement sur les fondamentaux, mais aussi sur les mesures de sécurité supplémentaires, telles que la double isolation ou l'isolation renforcée.
Ces mesures ne comprennent pas les dispositifs de mise à la terre et ne pas dépendre des conditions d'installation.
Изделие II класса.
Аппарат, в котором защита от поражения электрическим током обеспечивается не только стандартной изоляцией, но и применением дополнительных мер безопасности таких как двойная или усиленная изоляция. В приборах отсутствуют средства защитного заземления и защитные свойства окружающей среды не используются в качестве меры обеспечения безоп.

III **Apparecchio in classe III**
Apparecchio in cui la protezione contro la scossa elettrica si basa sull'alimentazione a bassissima tensione di sicurezza e in cui non si generano tensioni superiori alla stessa. Nota: un apparecchio in classe III non deve essere provvisto di messa a terra.
Class III Fixture
A fixture in which protection against an electric shock is guaranteed by the extremely low and safe voltage level of the power supply, which does not generate higher voltage levels. NB: a Class III fixture does not require grounding protection.
Leuchten der Schutzklasse III
Gerät in dem der Schutz gegen elektrische Stromschläge auf einer sehr niedrigen Spannung beruht und in dem keine höheren Spannungen entstehen
N.B.: Ein Gerät der Klasse III braucht keine Erdung.
Aparatos de clase III
Aparatos en los que la protección contra choques eléctricos se basa en una tensión de seguridad muy baja y no generar mayores tensiones. Nota: una Clase III no debe contar con la protección de tierra.
Luminaire classe III
Appareil dans lequel la protection contre les chocs électriques repose sur une basse tension de sécurité très et vous ne génèrent pas de tensions plus élevées. Note: la classe III ne doit pas être munis d'une protection au sol.
Изделие III класса.
Аппарат, в котором защита от поражения электрическим током основана на питании от источника безопасного сверхнизкого напряжения и в котором не возникают напряжения выше безопасного сверхнизкого напряжения. В оборудовании класса III не должно быть заземляющего зажима.

IP.. **Grado di protezione**
Il grado di protezione degli apparecchi di illuminazione viene indicato con la sigla "IP" seguita da due cifre caratteristiche.
- la prima indica la protezione contro la penetrazione dei corpi solidi e della polvere
- la seconda indica la protezione contro la penetrazione dei liquidi
Protection Index
The protection rating of the lighting appliances is shown by the letters "IP" followed by two characteristic digits
- the first of these two digits indicates the degree of protection that the appliances offer against the entry of solid foreign objects
- the second one indicates the protection against the entry of water
Berührungs- und Fremdkörperschutz
Der Schutzgrad des Beleuchtungsgerätes wird mit der Abkürzung "IP" und zwei bestimmten Zahlen genannt.
- die erste beschreibt den Schutz gegen das Eindringen von Festkörpern und Staub
- die zweite beschreibt den Schutz gegen Flüssigkeiten
Grado de protección
El grado de protección de los aparatos de iluminación se indica con el símbolo "IP" seguido de dos números característicos.
- el primer número indica el grado de protección contra la penetración de polvo, de cuerpos sólidos
- el segundo indica la protección contra los líquidos
Degré de protection
Le degré de protection des appareils d'éclairage est indiqué par le symbole "IP" suivi de deux numéros caractéristiques
- le premier numéro identifie la protection contre la pénétration des corps solides, de la poussière
- le deuxième identifie la protection contre la pénétration des liquides
Степень защиты.
Степень защиты светильника от внешних воздействий обозначается кодом IP и двумя цифрами.
- первая цифра обозначает степень защиты от проникновения внутрь посторонних предметов и пыли
- вторая цифра показывает стойкость к воздействию влаги

IK **Grado di protezione degli involucri per apparecchiature elettriche contro impatti meccanici esterni (codice IK)**
Degree of protection provided by enclosures for electrical equipment against external mechanical impacts (IK code)
Schutzarten durch Gehäuse für elektrische Betriebsmittel (Ausrüstung) gegen äußere mechanische Beanspruchungen (IK-Code)
Grado de protección de las envolturas para aparatos eléctricos contra impactos mecánicos exteriores (código IK)
Degrés de protection procurés par les enveloppes de matériels électriques contre les impacts mécaniques externes (code IK)
Степень защиты, обеспечиваемая корпусом для электрического оборудования от внешних механических воздействий (IK код)

☀ **Lampadina protetta contro esplosioni**
Lamp protected against explosion
Explosiongeschützte Lampe
Bombilla protegida contra la explosión
Lampes antidéflagrantes.
Лампа защищена от взрыва.

MARCHI / MARKS

RoHS RoHS - DIRETTIVA 2002/95/CE (Restriction of the use of certain Hazardous Substances in electrical and electronic equipment) Direttiva europea che limiti l'utilizzo di alcune sostanze pericolose (piombo, cadmio, mercurio, cromo esavalente, bifenili polibromurati, Eteri difendi polibromurati. A partire da 1 luglio 2006 tali sostanze non possono essere più impiegate nei prodotti elettrici ed elettronici, salvo deroghe su alcune applicazioni.
RoHS - DIRECTIVE 2002/95/CE (Restriction of the use of certain Hazardous Substances in electrical and electronic equipment). The European Directive restricts the use of some dangerous substances: lead, mercury, cadmium, hexavalent chromium, polybrominated biphenyls (PBB) or polybrominated diphenyl ethers (PBDE). From 1st July 2006 such substances shall not be used anymore in electrical and electronic equipment apart from exceptions on specific applications.
RoHS - RICHTLINIE 2002/95/CE (Restriction of the use of certain Hazardous Substances in electrical and electronic equipment). Die Eu Richtlinie stellt, dass ab dem 1. Juli 2006 neu in Verkehr gebrachte Elektro- und Elektronikgeräte kein Blei, Quecksilber, Cadmium, sechswertiges Chrom, polybromiertes Biphenyl (PBB) bzw. polybromierten Diphenylether (PBDE) enthalten sollen.
RoHS - DIRECTIVA 2002/95/CE (Restriction of the use of certain Hazardous Substances in electrical and electronic equipment). La Directiva impone que, a partir del 1 de julio de 2006, los nuevos aparatos eléctricos y electrónicos que se pongan en el mercado no contengan plomo, mercurio, cadmio, cromo hexavalente, polibromobifenilos (PBB) o polibromodifeniléteres (PBDE).
RoHS - DIRECTIVE 2002/95/CE (Restriction of the use of certain Hazardous Substances in electrical and electronic equipment). La directive européenne prévoit que à compter du 1er juillet 2006, les nouveaux équipements électriques et électroniques mis sur le marché ne contiennent pas de plomb, de mercure, de cadmium, de chrome hexavalent, de polybromobiphényles (PBB) ni de polybromodiphényléthers (PBDE).
RoHS - DIRETTIVA 2002/95/CE (Restriction of the use of certain Hazardous Substances in electrical and electronic equipment) Европейская директива, которая ограничивает использование некоторых опасных веществ (свинца, кадмия, ртути, шестивалентного хрома, полибромированных бифенилов (PBB) и полибромированных дифениловых эфиров (PBDE). С 1 июля 2006 года эти вещества не могут быть больше использованы для производства электрического и электронного оборудования, за исключением некоторых специальных применений.

EAC Marchio unico di certificazione EAC (EurAsian Certification) che sostituisce i marchi nazionali GOST (R per la Russia, B per Bielorussia e K per Kazakistan)
Unique brand of EAC certification (Eurasian Certification) which replaces the national GOST brands (R for Russia, B for Belarus and K for Kazakhstan).
Einiges Markenzeugnis EAC, als Ersatzung des Landesmarkengost (R für Russia, B für Bielorussia und K für Kazakistan).
Marca única de certificación EAC que substituye las marcas nacionales Gost (R por Russia, B por Belarus y K por Kazakistan).
Marque unique de conformité EAC, qui substitue les marques nationales Gost (R pour Russia, B pour Belarus et K pour Kazakistan).
EAC, англ. Eurasian Conformity — знак обращения, свидетельствующий о том, что продукция, маркированная им, прошла все установленные в технических регламентах Таможенного союза процедуры оценки.

SELV Bassissima tensione di sicurezza
Safety Extra Low Voltage

1...10 V Dimmer analogico con segnale di tensione continua 1...10V
Analogic dimmer with a direct voltage signal

 Dimmer a taglio di fase ascendente/discendente (TRIAC)
Phase cutting dimmer leading edge, trailing edge (TRIAC)

 Dimmer digitale con interfaccia DALI
Digital dimmer with DALI interface

 Dimmer con funzionalità DALI o pulsante normalmente aperto NA
Dimmer for DALI protocol or push button application

 Dimmer con pulsante normalmente aperto NA
Dimmer with push button NO

 Step Dim: accensione massima + 3 livelli di dimmerazione + spegnimento tramite sensore touch.
Step Dim: max on + 3 dimming levels + off through touch sensor.

 Alimentatore idoneo al montaggio indipendente
Independent driver can be mounted separately outside a luminaire

EM
1H/12H Emergenza integrata. Autonomia 1h / Tempo di ricarica 12h
Integrated emergency. Duration 1h/Recharging time 12h

MARCHI / MARKS

ECO LIGHT

CONSORZIO PER LA RACCOLTA E LO SMALTIMENTO DELLE APPARECCHIATURE DI ILLUMINAZIONE.

PANZERI CARLO SRL ADERISCE AL CONSORZIO ECOLIGHT – MILANO ITALY

WEEE - DIRETTIVA 2002/96/CE, 2003/108/CE (WASTE ELECTRICAL AND ELECTRONIC EQUIPMENT) RIFIUTI DI APPARECCHI ELETTRICI ED ELETTRONICI.

La direttiva valida su tutto il territorio dell'Unione Europea definisce una serie di misure allo scopo di prevenire la produzione di rifiuti di apparecchiature elettriche ed elettroniche; di promuovere il riutilizzo, il riciclo ed altre forme di recupero di tali tipologie di rifiuti; di limitare i rischi di impatto sull'ambiente derivanti dal trattamento e dallo smaltimento dei rifiuti in questione; di armonizzare le misure nazionali di gestione dei rifiuti elettrici ed elettronici.

Gli apparecchi di illuminazione marcati con l'apposito simbolo del cassonetto barrato  sono soggetti a raccolta differenziata separata dal resto dei rifiuti urbani.

Per la restituzione di un dispositivo dimesso, occorre servirsi dei sistemi di restituzione e di raccolta messi a disposizione nei singoli paesi di utilizzo.

PANZERI CARLO SRL JOINS CONSORZIO ECOLIGHT – MILANO ITALY

WEEE - DIRECTIVE 2002/96/CE, 2003/108/CE (WASTE ELECTRICAL AND ELECTRONIC EQUIPMENT).

The European Directive is applicable throughout the European Union and determines the measures in order to prevent the production of waste electrical and electronic equipment; to promote the re-use, the recycle and other forms of reutilization of these kind of waste; to restrict the risks of impact to the environment coming from treatment and disposal of these equipments; to harmonize national measures of managing waste electrical and electronic equipment.

Equipment marked with proper symbol of crossed container  may not be disposed of with household rubbish.

To return the used device, the return and collection systems available in every single Country must be used.

PANZERI CARLO SRL GEHÖRT DEM CONSORZIO ECOLIGHT (MILANO – ITALY) AN.

WEEE - RICHTLINIE 2002/96/CE, 2003/108/CE (WASTE ELECTRICAL AND ELECTRONIC EQUIPMENT).

Die Eu Richtlinie gibt den Rahmen für die EU-weit gültige Maßnahmen, um die Produktion von Elektro- und Elektronik-Altgeräte zu verhindern; um Rückführung und andere Formen von Wiederverwendung zu fördern; um Einschränkung der Risiken gegen die Umwelt, die diese Abfälle verursachen können; um die Ländermaßnahme im Rahmens der Elektro- und Elektronik-Altgeräte zu harmonisieren.

Das Gerät gezeigt mit der bestimmten Kennzeichnung  dürfen nicht mit dem Siedlungsabfall entsorgt werden.

Für die Rückgabe des Altgeräts muss man die verfügbare Rückgabe- und Sammelsysteme in jedem Gebrauchsland nutzen.

PANZERI CARLO SRL HACE PARTE DEL CONSORZIO ECOLIGHT – MILANO ITALY

WEEE - DIRECTIVA 2002/96/CE, 2003/108/CE (WASTE ELECTRICAL AND ELECTRONIC EQUIPMENT).

La directiva es valida en toda la Union Europea y señala las medidas necesarias para prevenir la producción de residuos de aparatos eléctricos y electrónicos; para promover el reutilizo, reciclo y otras formas de recuperio de estas tipologias de residuos; para limitar los efectos en el medio ambiente que vienen de los tratamientos y gestion de estos residuos; para armonizar las medidas nacionales de gestion de residuos de aparatos eléctricos y electrónicos.

El equipo marcado con signal de contenedor tachado  no debe eliminarse junto con la basura urbana.

Para la devolución de antiguo dispositivo utilizar los sistemas de recogida y devolución disponible en cada Pais.

PANZERI CARLO SRL ADHÈRE AU CONSORZIO ECOLIGHT – MILANO ITALY

WEEE - DIRECTIVE 2002/96/CE, 2003/108/CE (WASTE ELECTRICAL AND ELECTRONIC EQUIPMENT).

La directive valable sur tout le territoire de l'Union Européenne établi des mesures afin d'éviter la production de déchets d'équipements électriques et électroniques; d'encourager la réutilisation des équipements usagés, le recycle et autres formes de récupération de ces typologies de déchets; de limiter les risques sur l'environnement causés par le traitement de ces déchets et par la relative élimination; d'harmoniser les dispositions nationales de gestion des déchets électriques et électroniques.

Les appareils d'éclairage marqués avec le symbole du porte-poubelle barré,  sont sujet à la collecte séparée des autres déchets urbains. Pour la restitution d'un dispositif usagé, il faut se servir des systèmes de restitution et de collecte offerts dans chaque pays d'utilisation.

PANZERI CARLO SRL ВХОДИТ В СОСТАВ CONSORZIO ECOLIGHT – MILANO ITALY

WEEE - ДИРЕКТИВА 2002/96/CE, 2003/108/CE (WASTE ELECTRICAL AND ELECTRONIC EQUIPMENT) УТИЛИЗАЦИЯ ЭЛЕКТРИЧЕСКОГО И ЭЛЕКТРОННОГО ОБОРУДОВАНИЯ.

Директива действует на территории всего Европейского Союза и определяет ряд мер, целью которых является избежание накопления отходов электрического и электронного оборудования; содействие их повторному использованию, переработке и другим методам утилизации этого вида отходов; уменьшение рисков воздействия на окружающую среду при переработке и уничтожении отходов; приведение в соответствие национальных мер по контролю за утилизацией электрического и электронного оборудования.

Светильники, отмеченные символом с перечеркнутым мусорным контейнером,  нельзя выбрасывать с остальным бытовым мусором. Для их переработки следует обращаться в соответствующие государственные учреждения.

Pur mantenendo inalterate le proprie caratteristiche di base, i nostri articoli possono risultare parzialmente modificati rispetto a come sono raffigurati nel presente catalogo. Ciò è dovuto all'evoluzione a cui sottoponiamo i prodotti, con lo scopo di un miglioramento continuo. Anche i colori presentati nel catalogo sono da considerarsi puramente indicativi.

While maintaining the basic characteristics of the product, the Company reserves the right to make modifications at any time with the sole aim of improvement. The colours illustrated in the catalogue are intended only as examples. Unter Beibehaltung der wesentlichen Produktcharakteristiken behält sich die Firma jederzeit Änderungen zur Verbesserung der Produkte vor. Die in Katalog abgebildeten Farben sind unverbindlich.

Manteniendo las características base del producto, la Sociedad se reserva el derecho de realizar pequeños cambios con el fin de mejorar la calidad del producto. Los colores que se ven en el catálogo son sólo indicativos.

Tout en respectant les caractéristiques de base du produit, la Société se réserve le droit d'apporter modifications en tous les moments rien que pour amélioration. Les couleurs illustrées dans ce catalogue sont données à titre d'indication. Возможно некоторое отличие наших артикулов от их изображения в этом каталоге, при сохранении неизменными их основных характеристик. Это связано с нашим постоянным стремлением к совершенствованию моделей.

Отделки, представленные в каталоге, так же должны рассматриваться как чисто ориентировочные.

CREDITS

Pag. 17, 128, 129
Misuri - Firenze, Italia
Mimesi62 Arch. Ass.
Ph. Arch. L. Liverani

Pag. 12, 176, 184, 191, 309, 311
Confindustria - Monza, Italia
Arch. F. Pella, Sering Srl

Pag. 13, 179, 180, 182
Uffici Direzionali - Milano, Italia
General Contractor: Linea Design Srl
Chief Executive O. Bartezzaghi

Pag. 16
Studio Dentistico - L'Aquila, Italia
Arch. R. Neroni, Edif S.p.A.

Pag. 16, 201
Uffici TP - Ragusa, Italia
Arch. V. Leggio (La Luce srl)

Pag. 17, 344
Private house - Toscana, Italia
Arch. L. Doveri (Montesi Srl)
Ph. S. Rocchi



*Riconoscimento attribuito per oltre 50 anni di attività
Recognition given for over 50 years of continuous activity*



ADI MEMBER

ADI ASSOCIAZIONE PER IL DISEGNO INDUSTRIALE



PANZERI®

Panzeri Carlo S.r.l.
Via Padania, 8
20853 Biassono
Monza e Brianza Italy
T +39 039 2497483
F +39 039 2497396
panzeri@panzeri.it
export@panzeri.it

   PANZERI.IT

© Panzeri Carlo S.r.l.
AD_Piero Simonetto INTOHESIGN
Prepress INTOHESIGN
Photo INTOHESIGN
Print Asolana Group

March 2015

È vietata la riproduzione anche parziale di questo catalogo
It is forbidden to reproduce any part of this catalogue

PANZERI.IT