

FontanaArte



FontanaArte

History

Design made in Italy since 1932

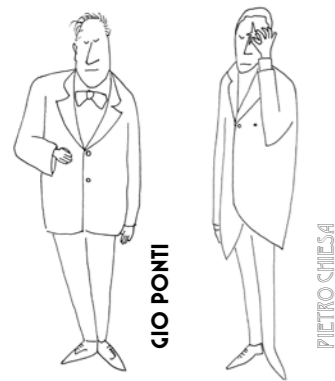

Fondata nel 1932 da Luigi Fontana, titolare di una importante industria impegnata nella lavorazione del vetro, e da Gio Ponti, FontanaArte è la prima azienda italiana ad affermarsi nel settore dell'interior design.

Gio Ponti, da sempre impegnato nella definizione di una nuova grammatica della decorazione contemporanea, chiama al suo fianco Pietro Chiesa, già proprietario di una bottega vetraia artigiana. Insieme, i due fanno rapidamente di FontanaArte uno dei più importanti protagonisti della elaborazione del paesaggio domestico italiano della prima modernità.

Founded in 1932 by Luigi Fontana, owner of an important glass manufacturing company, and Gio Ponti, FontanaArte was the first Italian business to establish itself in the interior design sector.

Continually experimenting with new ways of defining contemporary decoration, Gio Ponti brought in Pietro Chiesa, already owner of an artisan glass-making workshop. Together, the two rapidly turned FontanaArte into one of the most important players in the elaboration of early modernity for Italian home furnishing accessories.

Créée en 1932 par Luigi Fontana, qui dirigeait alors une importante entreprise industrielle spécialisée dans l'usinage du verre, et par Gio Ponti, FontanaArte est la première entreprise italienne à s'affirmer dans le secteur de la décoration d'intérieurs.

Gio Ponti, qui travaillait depuis toujours à la définition d'une nouvelle expression de la décoration contemporaine, invite Pietro Chiesa, alors propriétaire d'une boutique de verrerie artisanale, à le rejoindre. C'est ensemble qu'ils feront bientôt de FontanaArte l'un des principaux acteurs de l'élaboration du paysage domestique italien de la première modernité.

1932 von Luigi Fontana, Inhaber einer der wichtigsten Industrien der Glasherstellung, und von Gio Ponti gegründet, ist FontanaArte das erste italienische Unternehmen, das sich im Interior Design etabliert.

Seit jeher in der Definition einer neuen Formulierung des zeitgenössischen Dekors engagiert, ruft Gio Ponti Pietro Chiesa, Besitzer einer Werkstatt für Glasverarbeitung, an seine Seite. Gemeinsam machen die beiden FontanaArte schnell zu einem der wichtigsten Protagonisten in der Entwicklung der italienischen Wohnlandschaft der frühen Moderne.

Fundada en 1932 por Gio Ponti y por Luigi Fontana, titular de una importante empresa especializada en el trabajo del vidrio, FontanaArte es la primera empresa italiana en afirmarse en el sector del diseño de interiores.

Gio Ponti, ha estado desde siempre concentrado en redefinir y desarrollar el concepto de decoración contemporánea. Para ello, llama a su lado a Pietro Chiesa, antiguo propietario de un taller de vidrio artesanal. Juntos, convierten en poco tiempo a FontanaArte en uno de los principales protagonistas en el diseño del paisaje doméstico italiano del movimiento Moderno.



Negli anni Cinquanta la direzione artistica dell'azienda viene affidata a Max Ingrand. In questi anni la produzione aziendale vede un sostanziale ammodernamento dei processi, orientandosi verso un regime di produzione di tipo industriale.

In the fifties, Max Ingrand took over as artistic director at the company. This period was one of great modernization of company processes, heading towards a regime of industrial-style production.

Durant les années cinquante, c'est à Max Ingrand qu'est confiée la direction artistique de l'entreprise. Pendant cette période, FontanaArte met en œuvre une importante modernisation des processus et s'oriente vers une production de type industriel.

In den fünfziger Jahren wird die künstlerische Leitung des Unternehmens Max Ingrand anvertraut. In diesen Jahren erfährt die Firmenproduktion eine grundlegende Modernisierung der Verarbeitungsprozesse und wendet sich einer industriellen Produktion zu.

En los años 50 se confía la dirección artística de la empresa a Max Ingrand. Durante estos años la industria experimenta una modernización sustancial de los procesos y se actualiza hacia un régimen de producción de tipo industrial.



Gli anni '80 sono per FontanaArte un periodo di dinamismo e rigenerazione culturale che colloca definitivamente l'azienda nel novero dei protagonisti assoluti del design italiano e internazionale. La direzione artistica viene affidata a Gae Aulenti che, coinvolgendo molti progettisti fra loro diversi, giovanissimi o già affermati, imposta una ricerca che esplora le esperienze più espressive del design italiano.

For FontanaArte, the eighties were a dynamic period of cultural regeneration that asserted the company's role as one of the absolute main players in Italy and international design. Artistic direction was entrusted to Gae Aulenti who, by involving a large number of very diverse designers, very young or already famous, insisted on research that explored the most expressive experiences in Italian design.

Les années 80 sont, pour FontanaArte, une période marquée par un grand dynamisme et un renouveau culturel qui place définitivement l'entreprise au rang des plus grands acteurs du monde du design italien et international. La direction artistique est alors confiée à Gae Aulenti qui met en œuvre, en rassemblant autour d'elle des designers très différents les uns des autres, très jeunes ou déjà reconnus. Une recherche visant à explorer les expériences les plus expressives du design italien.

Die 1980er Jahre sind für FontanaArte eine dynamische Zeit kultureller Regeneration, die das Unternehmen definitiv in den Kreis der absoluten Protagonisten der italienischen und internationalen Designszene stellt. Die künstlerische Leitung geht an Gae Aulenti über, die viele unterschiedliche aufstrebende junge oder bereits bekannte Designer einbezieht und eine Recherche ansetzt, die die ausdrucksstärksten Erfahrungen des italienischen Designs erforscht.

Los años 80 son para FontanaArte un período de dinamismo y de cambio cultural que sitúan definitivamente a la empresa en el grupo de los protagonistas absolutos del diseño italiano e internacional. La dirección artística pasa a manos de Gae Aulenti que consigue reunir un equipo de grandes proyectistas muy diferentes entre sí, desde los más jóvenes hasta los más expertos, con el objetivo de explorar el lado más expresivo del diseño italiano.

Icons

Icons

Timeless elegance

Quando tecnologia, funzione e bellezza stanno insieme, prendono vita oggetti e progetti che non hanno data di nascita né scadenza, pronti ad attraversare indenni le trasformazioni sociali e le ondivaghe manie della moda. E' questa unità ideale (ciò che i Greci chiamavano "Techné") che FontanaArte ha costantemente perseguito, realizzando lampade, oggetti e complementi che hanno fatto la storia del design italiano, rimanendo sempre attuali e contemporanei. Oggetti senza tempo e dalle splendide forme, alcune delle quali sono diventati dei classici del design esposti nei più importanti musei del mondo.

At the point where technology, functionality and beauty merge, objects and projects cleave without beginning or end; priceless items which are destined to survive unscathed despite the ravages of social change and the fickle obsessions of fashion. And this is the perfect blend (which the Greeks called "Techné") which FontanaArte has relentlessly sought out, crafting table lamps, art objects and furnishing accessories which have made the history of Italian design, whilst staying up with the times and retaining a modern touch. Superbly fashioned timeless icons - some of which have become classics of design and are on show in the most important museums of the world.

La tecnología, la funcionalidad y la belleza unidas dan vida a objetos y proyectos sin fecha de nacimiento ni de vencimiento, que se mantienen indemnes a las transformaciones sociales y a las manías fluctuantes de la moda. Esta unión ideal (que los griegos llamaban "Techné") es lo que FontanaArte persigue constantemente, realizando lámparas, objetos y complementos que han ido construyendo la historia del diseño italiano sin nunca perder su actualidad y contemporaneidad. Objetos impercederos de espléndidas formas, algunas de las cuales se han convertido en clásicos del diseño expuestos en los principales museos del mundo.

Lorsque technologie, fonctionnalité et beauté se rejoignent, elles donnent vie à des objets et des projets qui n'ont ni date de naissance ni date de péremption, prêts à traverser indemnes les transformations sociales et les va-et-vient incessants de la mode. C'est ce mariage idéal (ce que les grecs appelaient le « Techné ») que la société FontanaArte a constamment recherché, en réalisant des lampes, des objets et des accessoires qui ont fait l'histoire du design italien, en restant toujours actuels et contemporains. Des objets intemporels aux formes splendides, dont quelques-uns sont devenus des classiques du design exposés dans les plus grands musées du monde.

Wenn Technologie, Funktion und Schönheit aufeinander treffen, rufen sie Gegenstände und Projekte ins Leben, die kein Entstehungs- und Verfallsdatum haben und unversehrt soziale Umwälzungen und Schwankungen der Mode überstehen. FontanaArte hat stets diese ideale Einheit (die Griechen nannten sie „Techné“) angestrebt und so Lampen, Objekte und Einrichtungsgegenstände geschaffen, die die Geschichte des italienischen Designs geschrieben haben und stets modisch-aktuell geblieben sind. Zeitlose Gegenstände mit herrlichen Formen, von denen einige Design-Klassiker geworden sind und in den wichtigsten Museen der Welt ausgestellt werden.

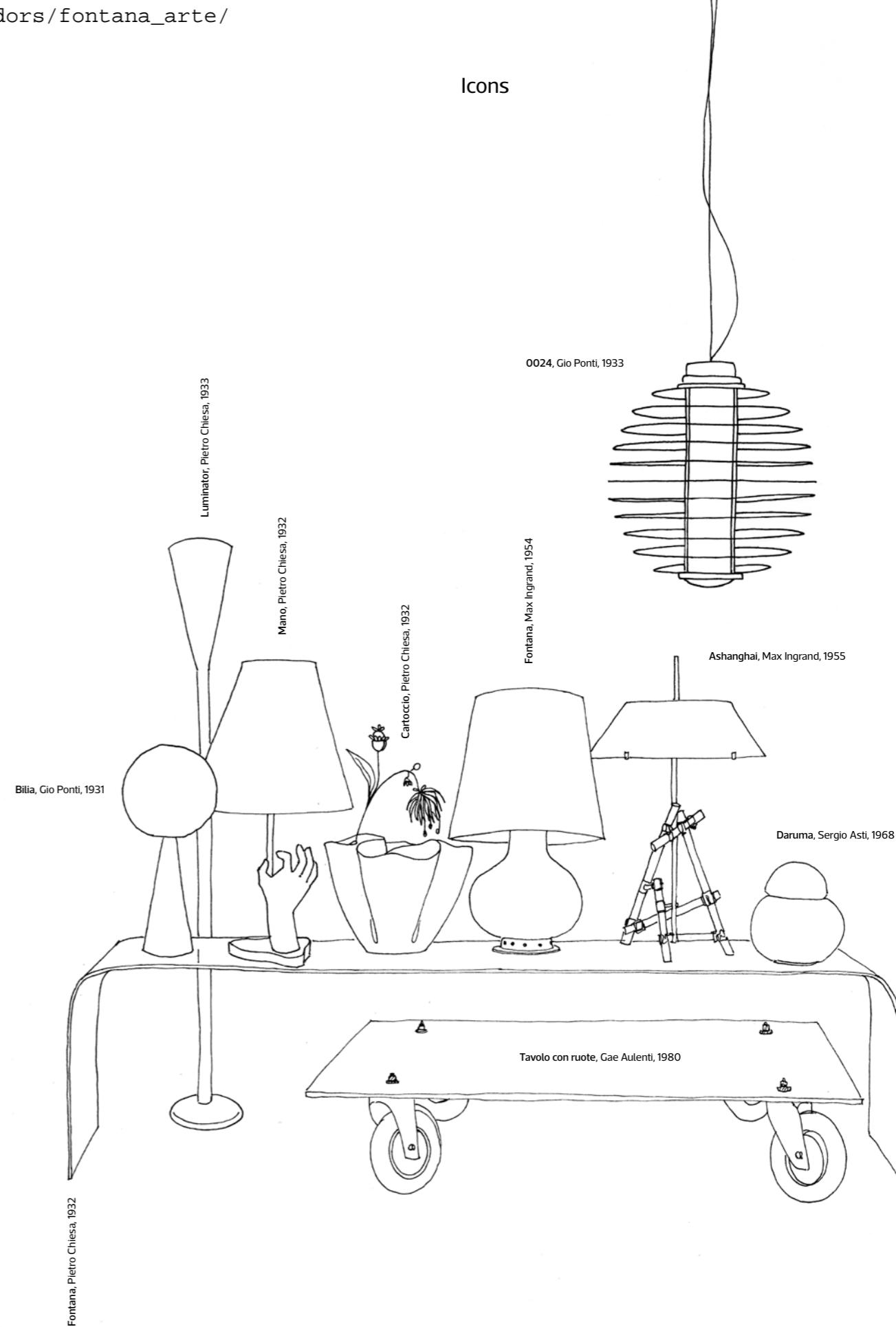

1998 ADI Compasso d'Oro Career Award

L'Associazione per il Design Industriale ADI assegna nel 1998 a FontanaArte il premio Compasso d'Oro alla Carriera, sottolineando nelle motivazioni come l'azienda, grazie alla collaborazione con progettisti diversi, abbia saputo creare un vivace clima creativo che ha riqualificato uno dei nomi storici del design italiano.

In 1998, the Italian Association for Industrial Design (ADI) awarded the Compasso d'Oro for career to FontanaArte, highlighting in its reasons how the company, by involving different designers, had managed to create a lively creative climate that had upgraded one of the historic names in Italian design.

L'Associazione per il Design Industriale (ADI) - Association pour le design industriel - décerne à FontanaArte, en 1998, le prix Compas d'Or à la carrière, en soulignant dans ses motivations le fait que l'entreprise, en collaborant avec différents concepteurs, a su créer un climat d'intense créativité qui a remis sur le devant de la scène des noms historiques du design italien.

Die italienische Gesellschaft für Industriedesign (ADI) verleiht dem Unternehmen FontanaArte 1998 den Industrie-Designpreis Compasso d'Oro für sein Lebenswerk und betont die Beweggründe dafür, wie das Unternehmen durch die Einbeziehung verschiedener Designer es verstanden hat, in den letzten zwanzig Jahren ein lebendiges, kreatives Klima zu schaffen, das einen der historischen Namen des italienischen Designs wieder aufgewertet hat.

En 1998, la Asociación del Diseño Industrial ADI concede a FontanaArte el premio Compás de Oro a la carrera, resaltando el modo en el que FontanaArte, junto a un gran equipo de proyectistas, ha conseguido crear un clima dinámico y creativo dando lugar a uno de los nombres más importantes e históricos del diseño italiano.

Today

Light and Movement: the Nice era

Nel 2010 FontanaArte entra a far parte di Nice, gruppo di riferimento internazionale nel settore dell'Home Automation. Luce e movimento: incontro ideale fra due aziende che da sempre puntano su design e innovazione.

FontanaArte, diventa grazie anche a Nice, il partner ideale per la realizzazione dei più ambiziosi progetti internazionali. Attenta alle esigenze ed evoluzioni del mercato in costante sviluppo, offre soluzioni illuminotecniche personalizzate in grado di soddisfare le esigenze tecniche ed estetiche di ogni realizzazione in ambito residenziale, pubblico, navale, hospitality.

Oggi FontanaArte è un marchio internazionale di prestigio la cui consolidata tradizione per l'eccellenza si rinnova in collezioni d'avanguardia. La filosofia di Gio Ponti è più viva che mai, tradotta in oggetti d'uso quotidiano che trascendono mutamenti sociali e tendenze transitorie.

In 2010, FontanaArte joined Nice spa, an international benchmark group in the sector of Home Automation. Light and movement: the ideal encounter between two companies that had always focused on design and innovation.

FontanaArte becomes, also thanks to Nice, the ideal partner for planning and production of the most ambitious international projects. Attentive to constantly changing market needs and evolution, they provide customized lighting engineering solutions that meet the technical and aesthetic requirements of any residential, public, ship or hospitality project.

Today FontanaArte is a prestigious international brand whose consolidated tradition of excellence lives on in cutting-edge collections. The philosophy of Gio Ponti is more topical than ever, translated into objects for everyday use that outlive social change and passing trends.

En 2010, FontanaArte entre dans le groupe Nice, un groupe d'envergure internationale dans le secteur de la domotique. Lumière et mouvement: une union idéale entre deux entreprises qui misent depuis toujours sur le design et l'innovation.

FontanaArte devient , grâce aussi à Nice, le partenaire idéal pour le développement et la réalisation des projets internationaux les plus ambitieux. Attentive aux exigences et aux développements d'un marché en constante évolution, elle offre des solutions d'éclairage personnalisées pour satisfaire les exigences techniques et esthétiques de tous les types de réalisation, dans le domaine résidentiel, public, naval ou réceptif.

FontanaArte est aujourd'hui une marque internationale de prestige qui, tout en perpétuant sa grande tradition de l'excellence, se renouvelle dans des collections d'avant-garde. La philosophie de Gio Ponti, plus vive que jamais, se traduit dans des objets d'usage quotidien qui vont au delà des évolutions de la société et les tendances éphémères.

Seit 2010 gehört FontanaArte zur Nice S.p.A., einem internationalen Konzern im Bereich Home Automation. Licht und Bewegung: eine ideale Begegnung zweier Unternehmen, die seit jeher auf Design und Innovation setzen.

FontanaArte wird, auch dank Nice, der ideale Partner für die Planung und Umsetzung der ehrgeizigsten internationalen Projekte zur Verfügung stehen. Durch ihre Aufmerksamkeit für die sich ständig verändernden Bedürfnisse des Marktes und seine Entwicklung bieten sie maßgeschneiderte Lichttechnik-Lösungen, die die technischen und ästhetischen Anforderungen jedes Projektes im öffentlichen, Wohn-, Nautik- oder Gastgewerbebereich erfüllen.

Heute ist FontanaArte eine internationale Prestigemärke, deren langbewährte Vorzüglichkeit sich in avantgardistischen Kollektionen erneuert. Die Philosophie von Gio Ponti ist lebendiger denn je und drückt sich in Alltagsgegenständen aus, die soziale Umwälzungen und vorübergehende Tendenzen überdauern.

Today

En 2010 FontanaArte pasa a formar parte del grupo Nice spa, grupo de referencia internacional en el sector de la automatización de la vivienda. Luz y movimiento: una unión perfecta entre dos empresas que se esfuerzan desde siempre por el diseño y la innovación.

FontanaArte se convierte, también gracias a Nice, el socio ideal para el desarrollo y la realización de los más ambiciosos proyectos internacionales. Atento a las necesidades y las evoluciones de un mercado en constante desarrollo, ofrece soluciones luminotécnicas personalizadas para satisfacer las exigencias técnicas y estéticas de cualquier obra en ámbito residencial, público, naval y de acogida.

Hoy FontanaArte es una prestigiosa marca internacional cuya consolidada tradición y excelencia se mantienen en sus nuevas colecciones vanguardistas. La filosofía de Gio Ponti sigue más viva que nunca, y se traduce en objetos de uso cotidiano que van más allá de las modas y tendencias pasajeras.

Projects

Projects



Excelsior Hotel Gallia, Milan - 0024 suspension lamp



Tutto il Giorno restaurant, New York - Chandelier suspension lamp



Bosco Verticale skyscraper, Milan - Avico suspension lamp



Bulgari boutique, Madrid - custom project



AP Hogeschool, Antwerp - bespoke Cheshire



Dodo boutique, London - Naska table lamp

Innovation

New collections, a new light experience

Au cours des trois dernières années, le catalogue FontanaArte s'est profondément renouvelé. Aux côtés de ses grands classiques, l'entreprise a présenté de nouvelles lampes. Bien qu'elles puissent sembler incohérentes par rapport à la tradition de FontanaArte, elles ont en réalité fait preuve du même caractère innovateur et anti-conformiste que les créations de ses débuts. Des projets rendus possibles grâce à l'entrée du groupe Nice qui a apporté un grand savoir-faire et a facilité un processus d'expérimentation continu.

Negli ultimi tre anni il catalogo FontanaArte si è profondamente rinnovato. Accanto alle classiche lampade icone, l'azienda ha presentato nuove e innovative collezioni. Apparentemente incoerenti rispetto alla tradizione di FontanaArte, i nuovi progetti dimostrano lo stesso carattere innovativo e anticonformista delle origini. Progetti resi possibili anche dall'acquisizione da parte del gruppo Nice che ha portato un grande know-how e ha agevolato un processo di sperimentazione continuo.

In den letzten drei Jahren hat sich der Produktkatalog von FontanaArte tiefgehend erneuert. Neben den historischen Produkten hat das Unternehmen versucht neue Leuchten vorzustellen. Diese scheinbar von der Tradition FontanaArtes losgelösten Produkte haben doch den innovativen, nonkonformistischen Charakter, der die Ursprünge des Unternehmens prägt. Die Projekte waren auch durch den Beitrag der Gruppe Nice möglich, die großes Know-how eingebracht und den Prozess kontinuierlicher Erprobung erleichtert hat.

FontanaArte's catalogue has completely changed face over the last three years. Next to the classical icon lamps, the company has presented new and innovative collections. Although in apparent contrast with its established traditions, this move has actually bared FontanaArte's innovative and unorthodox soul. The Nice group acquisition has not only led to a pooling of precious know-how, it has also facilitated to the experimentation process.

En los últimos tres años, el catálogo de FontanaArte se ha renovado profundamente. Además de sus productos históricos, la empresa ha presentado unas lámparas nuevas. Apparentemente incoherentes con la tradición de FontanaArte, en realidad han demostrado el mismo carácter innovador y anticonformista de los orígenes. Proyectos que se han hecho posibles gracias a la adquisición por parte del grupo Nice, que ha aportado un gran saber hacer y ha facilitado un proceso de experimentación continuo.



Lunaire, Ferréol Babin, 2013

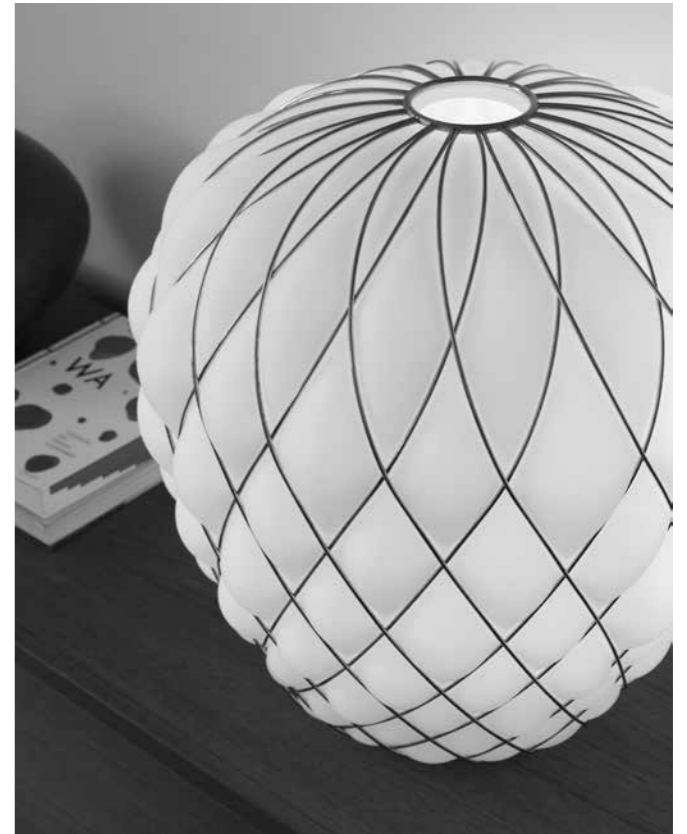

Pinecone, Paola Navone, 2016



Io, Claesson Koivisto Rune, 2015



Volée, Odo Fioravanti, 2015



Bianca, Matti Klenell, 2015

Quality

Perfect combination of age-old craftsmanship and technological innovation

FontanaArte coniuga la capacità di realizzare ancora oggi prodotti semi-artigianali con la cura nel produrre prodotti complessi in serie, ottenuti mediante investimenti in termini di sviluppo e attrezzature. Uno straordinario connubio fra artigianalità e innovazione tecnologica. Tecniche antiche e gesti lenti da un lato, materiali innovativi, sorgenti luminose di ultima generazione e processi produttivi in serie dall'altra. Una singolarità produttiva che ha radici nella storia dell'azienda e ne costituisce l'identità stessa. Già 80 anni fa Gio Ponti e Pietro Chiesa avevano dimostrato di essere particolarmente interessati al costante confronto fra forme, tecniche e lavorazioni tradizionali da un lato con le innovazioni e le possibilità offerte dalla grande produzione industriale dall'altro.

Still today, as a result of its investments in development and equipment, FontanaArte successfully mixes a talent for semi-handmade products with the stringent standards of complex serial manufacturing. A providential combination of age-old craftsmanship and technological innovation. Old world techniques and an unruffled approach on the one hand; innovative materials, light sources of last generation and serial manufacturing processes on the other. A manufacturing edge which sinks its roots in time and symbolises the very essence of the company. As far back as 80 years ago Ponti and Chiesa showed a keen interest in the contrast between traditional shapes, techniques and work processes and the innovational benefits and advantages provided by industrial production lines.

FontanaArte conjugue la capacité à réaliser encore aujourd'hui des produits semi-artisanaux avec le soin apporté à la fabrication de produits complexes en série, grâce à d'importants investissements en termes de développement et d'équipements. Une union parfaite de l'artisanat et de l'innovation technologique. Techniques anciennes et gestes lents d'un côté, matériaux innovants, sources de lumière de dernière génération et processus de production en série de l'autre. Une production singulière qui retrouve ses racines dans l'histoire de l'entreprise et en constitue l'identité même. Déjà il y a 80 ans, Ponti et Chiesa avaient montré un intérêt tout particulier pour la confrontation constante des formes, techniques et réalisations traditionnelles avec les innovations et les possibilités offertes par la production industrielle à grande échelle.

FontanaArte besitzt die Fähigkeit, noch heute halb-handwerkliche Produkte herzustellen und sie mit sorgfältiger, komplexer Serienproduktion zu verbinden. Dies ist durch Investition in den Bereichen Entwicklung und Ausrüstungen möglich und ein Zeichen für die herausragende Verbindung von Handwerklichkeit und technologischer Innovation. Alte Techniken und langsame Bearbeitungen einerseits, innovative Materialien, Lichtquellen der letzten Generation und serienmäßige Produktionsprozesse andererseits. Eine produktive Besonderheit, die ihre Wurzeln in der Geschichte des Unternehmens hat und seine Identität selbst darstellt. Bereits vor 80 Jahren zeigten die künstlerischen Leiter Ponti und Chiesa besonderes Interesse für einen konstanten Vergleich von Formen, Techniken und traditionellen Bearbeitungen mit den von der großen Industrieproduktion gebotenen Innovationen und Möglichkeiten.

FontanaArte conjuga la capacidad de realizar aún hoy productos semiartesanales con la atenta elaboración de productos complejos en serie, respaldada por inversiones en investigación y desarrollo. Una extraordinaria unión entre artesanía e innovación tecnológica. Por un lado, técnicas antiguas y movimientos lentos; por otro, materiales innovadores, fuentes de luz de última generación y procesos productivos en serie. Una producción de carácter único enraizada en la historia de la empresa que constituye su identidad misma. Ya 80 años atrás Ponti y Chiesa habían demostrado estar particularmente interesados en la confrontación constante de formas, técnicas y procesos tradicionales con las innovaciones y las posibilidades ofrecidas por la gran producción industrial.

Quality

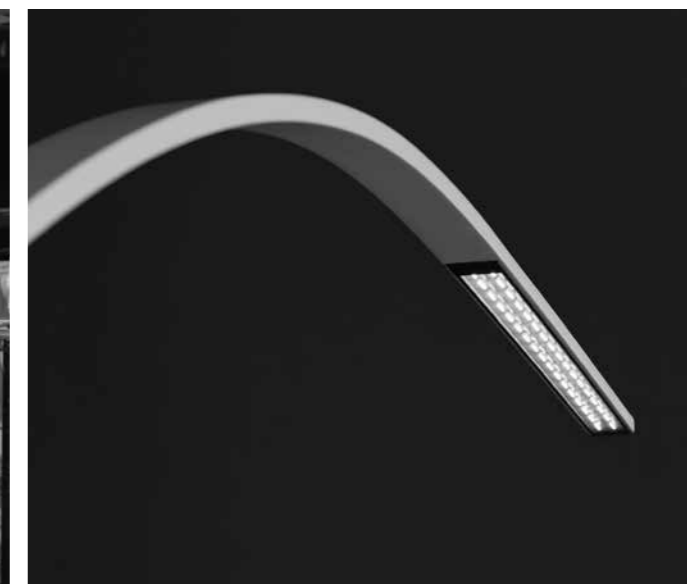

Designers



Marco Acerbis



Dino Amato



Gianni Arnaudo



Sergio Asti



Gae Aulenti



Ferréol Babin



Emmanuel Babled



Shigeru Ban



Dante Bonuccelli



Luisa Calvi, Mauro Merlini
Carlos Moya



Livio Castiglioni



Piero Castiglioni



Caturegli Formica
Architetti Associati



Pierluigi Cerri



Pietro Chiesa



David Chipperfield



Claesson Koivisto Rune



Carlo Colombo



Andreas Engesvik



Ferrara Palladino
e Associati



Odo Fioravanti



Form Us With Love

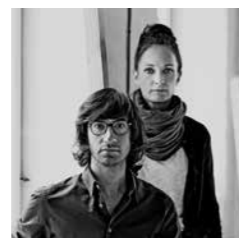

GamFratesi

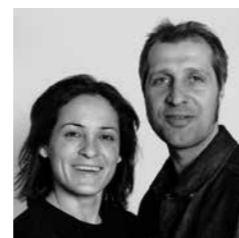

Harry & Camila



Chris Hardy

Designers



Steven Holl



Max Ingrand

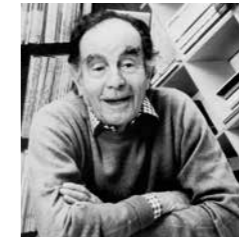

Vico Magistretti



Roberto Menghi



Metis Lighting



Paola Navone



Luciano Pagani
Angelo Perversi



Park Associati



Alessandro Pedretti



Gabi Peretto

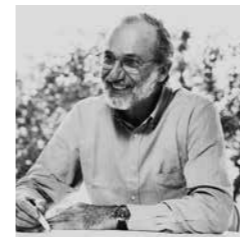

Renzo Piano

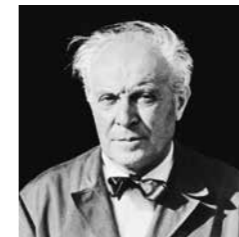

Gio Ponti



Daniela Puppa



Franco Raggi



Karim Rashid



Denis Santachiara



Alvaro Siza



Studio Beretta



Studio Drift



Studio Klass



Mika Tolvanen



Carlo Tamborini



Voon Wong
+ Benson Saw



Paolo Zani

Visual index

LAMPADRE DA TAVOLO
TABLE LAMPS
LAMPES DE TABLE
TISCHLEUCHTEN
LÁMPARAS DE SOBREMESA

Visual index

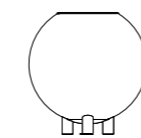

GLOBO DI LUCE
Roberto Menghi
pag. 154

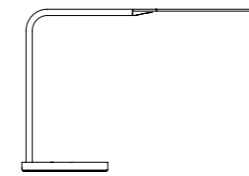

KINX
Karim Rashid
pag. 176

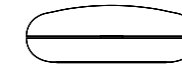

LOOP
Voon Wong + Benson Saw
pag. 180

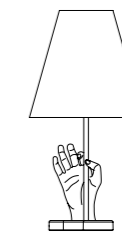

MANO
Pietro Chiesa
pag. 192



MARGARET
Vico Magistretti
pag. 196

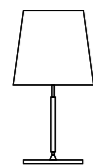

2198
Historical Archive
pag. 42

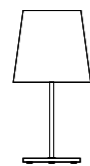

3247
Historical Archive
pag. 44

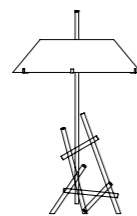

ASHANGHAI
Max Ingrand
pag. 58

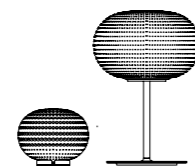

BIANCA
Matti Klenell
pag. 70



BILIA
Gio Ponti
pag. 82

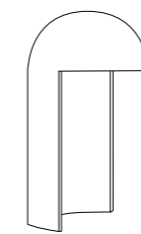

MILANO 2015
Carlo Colombo
pag. 200

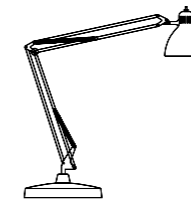

NASKA 1, 2, NASKETTA
Historical Archive
pag. 202

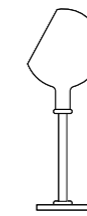

PAROLA
Gae Aulenti / Piero Castiglioni
pag. 226

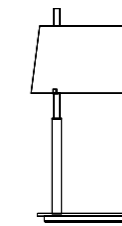

PASSION
Studio Beretta
pag. 230

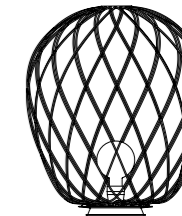

PINECONE
Paola Navone
pag. 236

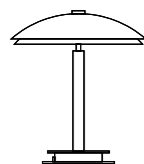

BIS/TRIS
Historical Archive
pag. 84



BLOM
Andreas Engesvik
pag. 88



CHESHIRE
GamFratesi
pag. 104



CHIARA
Technical Department
pag. 110

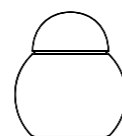

DARUMA
Sergio Asti
pag. 120

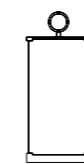

PIRELLINA
Gio Ponti
pag. 240

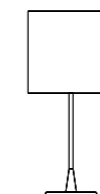

SARA
Pierluigi Cerri (Gregotti Associati)
pag. 256

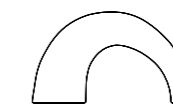

THOR
Luciano Pagani / Angelo Perversi
pag. 278

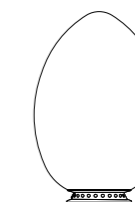

UOVO
Historical Archive
pag. 282



VOLÉE
Odo Fioravanti
pag. 296

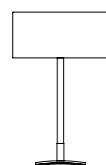

DRUM
Franco Raggi
pag. 122

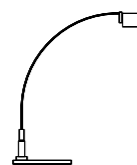

FALENA
Alvaro Siza
pag. 126

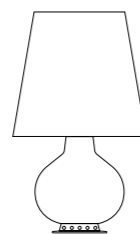

FONTANA
Max Ingrand
pag. 140



FONTANA TOTAL BLACK
Max Ingrand, 2014 edition
pag. 146

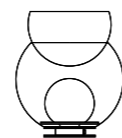

GIOVA
Gae Aulenti
pag. 150



YUPIK
Form Us With Love
pag. 306

Visual index

Visual index

LAMPADE DA TERRA
FLOOR LAMPS
LAMPADAIRES
STEHLEUCHTEN
LÁMPARAS DE SUELO

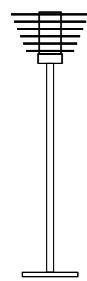

0024
Gio Ponti
pag. 38



3247
Historical Archive
pag. 44

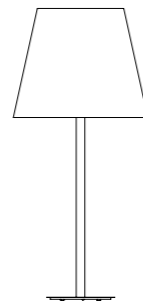

AMAX
Charles Williams
pag. 52



BIANCA
Matti Klenell
pag. 70



CHESHIRE
GamFratesi
pag. 104



PASSION
Studio Beretta
pag. 230



PIRELLONE
Gio Ponti
pag. 240



POLARIS
Marco Acerbis
pag. 244



PRIMA SIGNORA
Daniela Puppa
pag. 246



RILUMINATOR
Pietro Chiesa, 2014 edition
pag. 254

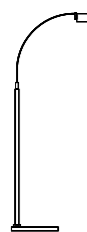

FALENA
Alvaro Siza
pag. 126



FLÛTE, FLÛTE MAGNUM
Franco Raggi
pag. 134



LUMEN
Historical Archive
pag. 184



LUMINATOR
Pietro Chiesa
pag. 186



NASKA 1, 2, NASKETTA
Historical Archive
pag. 202



SARA
Pierluigi Cerri (Gregotti Associati)
pag. 256



SCINTILLA
Livio Castiglioni / Piero Castiglioni
pag. 260



VERTIGO
Marco Acerbis
pag. 292

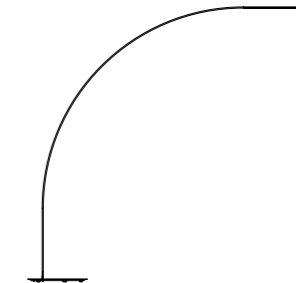

YUMI
Shigeru Ban
pag. 302



NOBI
Metis Lighting
pag. 208



NOBI 4
Metis Lighting
pag. 216



NUOVA SEGNO TRE
Pierluigi Cerri (Gregotti Associati)
pag. 218



ODEON
Studio Klass
pag. 220



PAROLA, PAROLONA
Gae Aulenti / Piero Castiglioni
pag. 226

Visual index

LAMPADRE A SOSPENSIONE
SUSPENSION LAMPS
SUSPENSIONS
HANGELEUCHTEN
LÁMPARAS DE TECHO

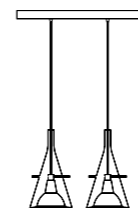

FLÛTE 2
Franco Raggi
pag. 134

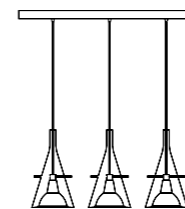

FLÛTE 3
Franco Raggi
pag. 134



GLOBO DI LUCE
Roberto Menghi
pag. 154

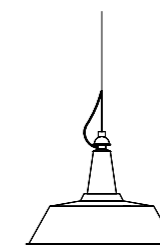

HUNA
Technical Department
pag. 160



IGLOO
Studio Klass
pag. 166

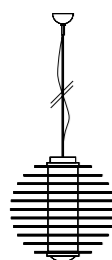

0024
Gio Ponti
pag. 38

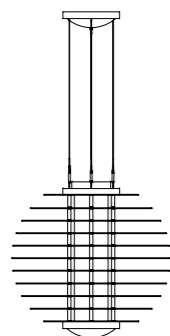

0024XXL
Gio Ponti
pag. 38

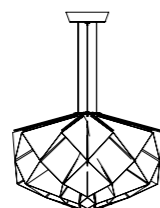

ALBEDO
Studio Drift
pag. 48

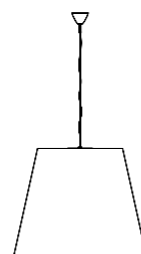

AMAX
Charles Williams
pag. 52

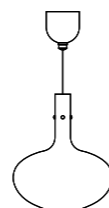

A TOMIC
Paolo Zani
pag. 62

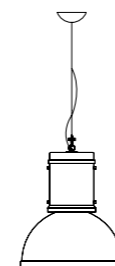

LAMPARA
Technical Department
pag. 178



NOBI
Metis Lighting
pag. 208



NOBI 2
Metis Lighting
pag. 212

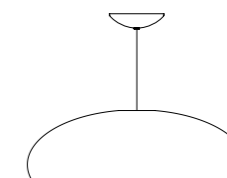

PANGEN
Historical Archive
pag. 222



PAROLA
Gae Aulenti / Piero Castiglioni
pag. 226

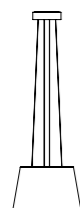

AUREA
Denis Santachiara
pag. 64

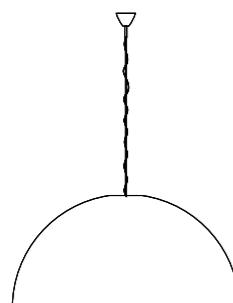

AVICO
Charles Williams
pag. 66

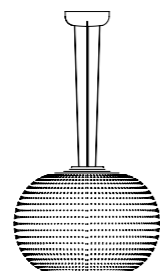

BIANCA
Matti Klenell
pag. 70

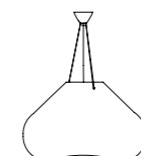

BOLLA
Harry & Camila
pag. 92

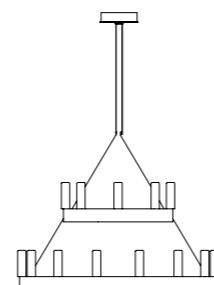

CHANDELIER
David Chipperfield
pag. 100



PASSION
Studio Beretta
pag. 230



PINECONE
Paola Navone
pag. 236

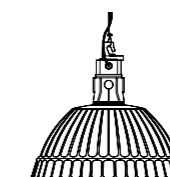

PUDDING
Historical Archive
pag. 248



SCINTILLA
Livio Castiglioni / Piero Castiglioni
pag. 260

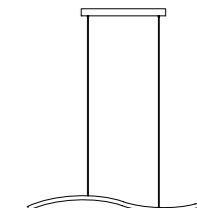

SERPENTINE
Gabi Peretto
pag. 264

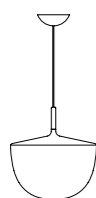

CHESHIRE
GamFratesi
pag. 104

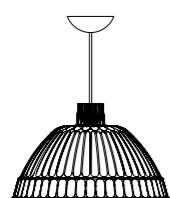

CLOCHE
Historical Archive
pag. 112

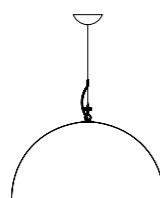

CUPOLA
Historical Archive
pag. 118

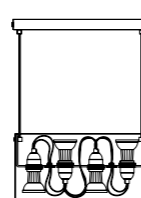

DUPLEX
Carlo Tamborini
pag. 124



FLÛTE, FLÛTE MAGNUM
Franco Raggi
pag. 134



TUBO LED
Technical Department
pag. 280

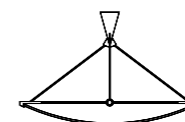

VELO
Franco Raggi
pag. 288

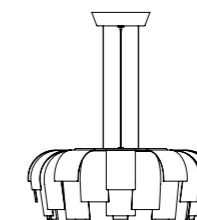

WIG
Chris Hardy
pag. 300

Visual index

LAMPADE DA PARETE
WALL LAMPS
APPLIQUES
WANDLEUCHTEN
LÁMPARAS DE PARED

Visual index

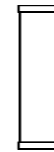

MARISTELLA
Historical Archive
pag. 198

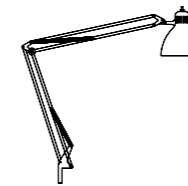

NASKA 1, 2, NASKETTA
Historical Archive
pag. 202

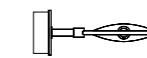

NOBI
Metis Lighting
pag. 208

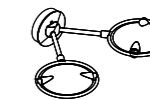

NOBI 2
Metis Lighting
pag. 212



PAROLA
Gae Aulenti / Piero Castiglioni
pag. 226

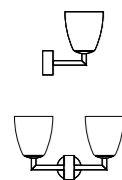

006
Historical Archive
pag. 34



ANANAS
Vico Magistretti
pag. 56

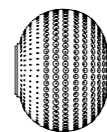

BIANCA
Matti Klenell
pag. 70



BONNET
Odo Fioravanti
pag. 96



BRUCO
Vico Magistretti
pag. 98

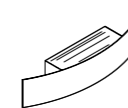

RIGA
Paolo Zani
pag. 250



SARA
Pierluigi Cerri (Gregotti Associati)
pag. 256

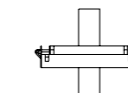

SCINTILLA
Livio Castiglioni / Piero Castiglioni
pag. 260



SILLABA
Piero Castiglioni
pag. 266

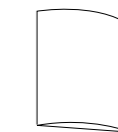

SIMPLE WHITE
Historical Archive
pag. 272

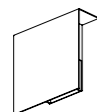

CORRUBEDO
David Chipperfield
pag. 116

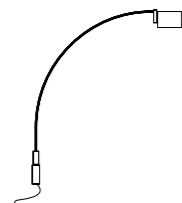

FALENA
Alvaro Siza
pag. 126



FLEX
Karim Rashid
pag. 132

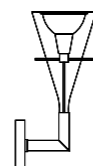

FLÛTE
Franco Raggi
pag. 134



GRAAL
Gianni Arcaudo
pag. 158

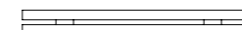

SIMPLICITY
Gabi Peretto
pag. 274



SOLE
Dino Amato
pag. 276



UOVO
Historical Archive
pag. 282

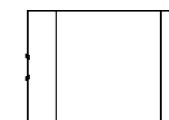

VELO
Franco Raggi
pag. 288

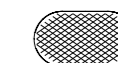

VITRO
Emmanuel Babled
pag. 294

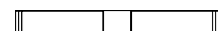

ICEBERG
Park Associati
pag. 162



IO
Claesson Koivisto Rune
pag. 168



KIASMA
Steven Holl
pag. 174

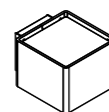

LOUNGE
Luisa Calvi / Mauro Merlini / Carlos Moya
pag. 182

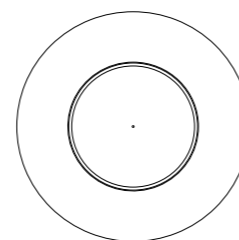

LUNAIRE
Ferréol Babin
pag. 188



VOLÉE
Odo Fioravanti
pag. 296



YVES
Gabi Peretto
pag. 308

Visual index

Visual index

LAMPADE DA SOFFITTO
CEILING LAMPS
PLAFONNIERS
DECKENLEUCHTEN
PLAFONES

ARCHITECTURAL

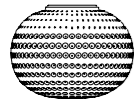

BIANCA
Matti Klenell
pag. 70

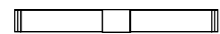

ICEBERG
Park Associati
pag. 162

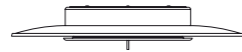

LUNAIRE
Ferréol Babin
pag. 188

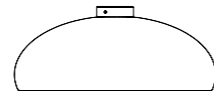

PANGEN
Historical Archive
pag. 222



SILLABA
Piero Castiglioni
pag. 266

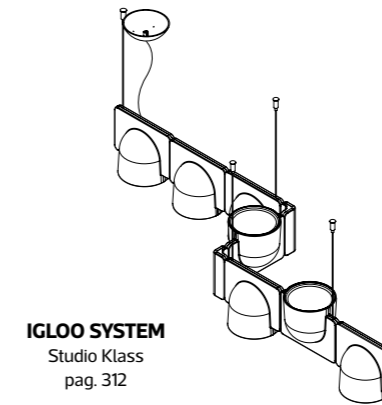

IGLOO SYSTEM
Studio Klass
pag. 312



SLOT
David Chipperfield
pag. 318

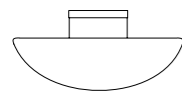

SILLABONE
Piero Castiglioni
pag. 270



SOLE
Dino Amato
pag. 276

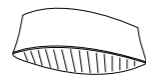

VITRO
Emmanuel Babled
pag. 294

Visual index

LAMPADE DA ESTERNO
OUTDOOR LAMPS
LAMPES D'EXTÉRIEUR
AUSSENLEUCHTEN
LÁMPARAS DE EXTERIOR

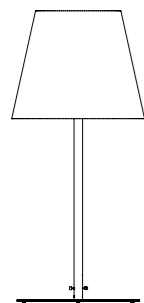

AMAX
Charles Williams
pag. 322

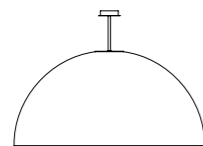

AVICO
Charles Williams
pag. 326

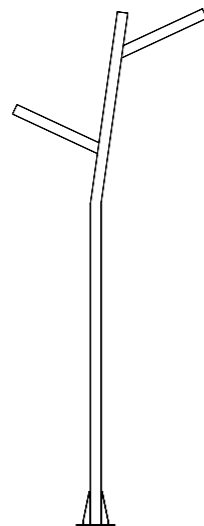

BOTREE
Ferrara Palladino e Associati
pag. 328



CORRUBEDO
David Chipperfield
pag. 330



KODO
Metis Lighting
pag. 332

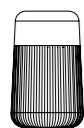

KOHO
Mika Tolvanen
pag. 334

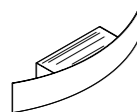

RIGA
Paolo Zani
pag. 336

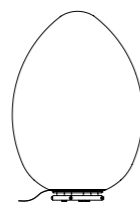

UOVO
Historical Archive
pag. 338

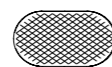

VITRO
Emmanuel Babled
pag. 342

Visual index

HOME TO LIVE



CARTOCCIO
Pietro Chiesa
pag. 346



CARTOCCIO Q
Pietro Chiesa
pag. 346



FONTANA
Pietro Chiesa
pag. 350



TAVOLINO 1932
Gio Ponti
pag. 352



TAVOLO CON RUOTE
Gae Aulenti
pag. 354

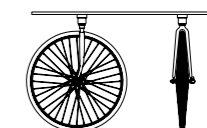

TOUR
Gae Aulenti
pag. 360

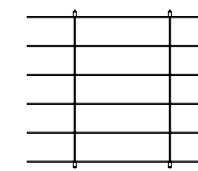
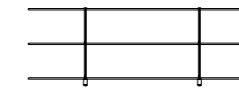
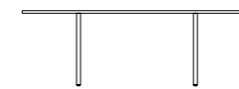

TESO COLLECTION
Renzo Piano
pag. 356

Chronological index

Alphabetical index

NAME	YEAR		NAME	YEAR		LIGHTS TO LIVE		HOME TO LIVE					
Bilia	1931	82	Bolla	2003	92	006	34	Globo di Luce	154	Riluminator	254	Cartoccio, Cartoccio Q	346
0024	1931	38	Bruco	2003	98	0024, 0024XXL	38	Graal	158	Sara	256	Fontana	350
Cartoccio	1932	344	Chiara	2003	110	2198	42	Huna	160	Scintilla	260	Tavolino 1932	352
Fontana	1932	348	Iceberg	2003	162	3247	44	Iceberg	162	Serpentine	264	Tavolo con Ruote	354
Mano	1932	192	Loop	2003	180	Albedo	48	Igloo	166	Sillaba	268	Teso Collection	356
Tavolino 1932	1932	352	Lounge	2003	182	Amax	52	Igloo System	310	Sillabone	270	Tour	360
006	1933	34	Chandelier	2004	100	Amax (outdoor)	320	Io	168	Simple White	272		
Luminator	1933	186	Passion	2004	230	Ananas	56	Kiasma	174	Simplicity	274		
Naska	1933	202	Aurea	2005	64	Ashanghai	58	Kinx	176	Slot	318		
Bis, Tris	1950	84	Corrubedo	2005	116	A Tomic	62	Kodo	332	Sole	276		
2198	1954	42	Drum	2005	122	Aurea	64	Koho	334	Thor	278		
3247	1954	44	Slot	2005	318	Avico	66	Lampara	178	Tubo Led	280		
Fontana	1954	140	Vertigo	2005	292	Avico (outdoor)	324	Loop	180	Uovo	282		
Lumen	1954	184	Avico	2006	66	Bianca	70	Lounge	182	Uovo (outdoor)	338		
Ashanghai	1955	58	Polaris	2007	244	Bilia	82	Lumen	184	Velo	288		
Pangen	1961	222	Graal	2008	158	Bis, Tris	84	Luminator	186	Vertigo	292		
Giova	1964	150	Riga	2008	250	Blom	88	Lunaire	188	Vitro	294		
Huna	1965	160	Botree	2009	328	Bolla	92	Mano	192	Vitro (outdoor)	342		
Lampara	1965	178	Yves	2009	308	Bonnet	96	Margaret	196	Volée	296		
Pirellone, Pirellina	1967	240	Simplicity	2010	274	Botree	326	Maristella	198	Demi Volée	296		
Daruma	1968	120	Serpentine	2011	264	Bruco	98	Milano 2015	200	Wig	300		
Globo di Luce	1968	154	Tubo Led	2011	280	Chandelier	100	Naska 1, Naska 2, Nasketta	202	Yumi	302		
Scintilla	1972	260	Wig	2011	300	Cheshire	104	Nobi	208	Yupik	306		
Uovo	1972	282	Yumi	2011	302	Chiara	110	Nobi 2	212	Yves	308		
Cupola	1979	118	Albedo	2013	48	Cloche	112	Nobi 4	216				
Parola, Parolona	1980	226	Blom	2013	88	Corrubedo	116	Nuova Segno Tre	218				
Tavolo con ruote	1980	354	Cheshire	2013	104	Corrubedo (outdoor)	328	Odeon	220				
Teso collection	1985	356	Koho	2013	334	Cupola	118	Pangen	222				
Nuova Segno Tre	1988	218	Odeon	2013	220	Daruma	120	Parola, Parolona	226				
Sillaba	1988	266	Yupik	2013	306	Drum	122	Passion	230				
Sillabone	1988	270	Bonnet	2014	96	Duplex	124	Pinecone	236				
Velo	1989	288	Cloche	2014	112	Falena	126	Pirellone, Pirellina	240				
Nobi	1992	208	Igloo	2014	166	Flex	132	Polaris	244				
Prima Signora	1992	246	Igloo System	2014	312	Flûte, Flûte Magnum	134	Prima Signora	246				
Sara	1993	256	Lunaire	2014	188	Fontana	140	Pudding	248				
Tour	1993	360	Riluminator	2014	254	Fontana Total Black	146	Riga	250				
Falena	1994	126	Vitro	2014	294	Giova	150	Riga (outdoor)	336				
Simple White	1994	272	Bianca	2015	70								
Maristella	1995	198	Flex	2015	132								
Pudding	1995	248	Io	2015	168								
Kodo	1998	332	Kinx	2015	176								
Ananas	1999	56	Milano 2015	2015	200								
Flûte, Flûte Magnum	1999	134	Volée	2015	296								
Duplex	2000	124	Demi Volée	2015	296								
Kiasma	2000	174	Pinecone	2016	236								
Margaret	2000	196											
Thor	2000	278											
A Tomic	2003	62											
Amax	2003	52											

LIGHTS TO LIVE

006

Historical Archive, 1933

Storica collezione di lampade da parete dal design moderno ed elegante. Diffusori in vetro soffiato e satinato bianco e struttura in metallo cromato. Disponibile anche nella versione singola.

Historische Kollektion von Wandleuchten mit modernem und elegantem Design. Diffusoren aus mundgeblasenem Opalglas und verchromter Metallstruktur. Erhältlich auch in der Einzelversion.

Historic collection of wall lamps with elegant modern design. Diffusers in frosted white blown glass and structure in chromed metal. Also available in a single version.

Histórica colección de lámparas de pared de diseño moderno y elegante. Difusores de vidrio soplado y satinado blanco y estructura de metal cromado. Disponible también en versión individual.

Collection historique d'appliques au design contemporain et élégant. Diffuseurs en verre soufflé satiné blanc et structure en métal chromé. Également disponible en version simple.



Wall



0024, 0024XXL

Gio Ponti, 1932

Sequenza di dischi orizzontali in vetro temperato trasparente per un'autentica installazione luminosa. Disponibile da terra e da sospensione, anche in formato XXL, che triplica il diametro della versione classica, fino a raggiungere i 150 cm. Un protagonismo deciso per arredare anche spazi di grandi dimensioni con un'eleganza intramontabile.

Eine Folge von waagerechten Scheiben aus transparentem getempertem Glas für eine authentische Lichtinstallation. Erhältlich als Boden- und Pendelleuchte, auch im Format XXL, bei dem der Durchmesser der klassischen Version verdreifacht wird und 150 cm erreicht. Ein entschiedener Protagonist, um auch große Räume zeitlos elegant einzurichten.

A series of horizontal discs in clear tempered glass for a true light installation. Available in floor and suspension versions, also in an XXL size with triple the diameter of the classic lamp, reaching 150 cm. Its jumbo personality brings timeless elegance to even the largest of interiors.

Secuencia de discos horizontales de vidrio templado transparente para crear una auténtica instalación luminosa. Está disponible como lámpara de pie o de techo y en formato XXL, que triplica el diámetro de la versión clásica hasta alcanzar los 150 cm. Un marcado protagonismo que permite decorar ambientes de grandes dimensiones con una elegancia imperecedera.

Série de disques horizontaux en verre trempé transparent pour une véritable installation lumineuse. Disponible dans les versions lampadaire et suspension, également au format XXL dont le diamètre de 150 cm est triplé par rapport à la version classique. Un élément d'ameublement à la présence forte pour éclairer, avec une élégance indémodable, les espaces les plus vastes.





0024XXL / 0024

2198

Historical Archive, 1954

Lampada da tavolo con stelo in legno di pero, diffusore in vetro soffiato bianco satinato e base in metallo verniciato color alluminio.

Table lamp with stem in pear wood, diffuser in frosted white blown glass and base in aluminum color painted metal.

Lampe de table avec tige en poirier, diffuseur en verre soufflé blanc satiné et base en métal laqué aluminium.

Tischleuchte mit Stab aus Birnenholz, Diffusor aus weißem mundgeblasenem Opalglas und Metallbasis mit aluminiumfarbener Lackierung.

Lámpara de sobremesa con pie de madera de pero, difusor de vidrio soplado blanco satinado y base de metal pintado color aluminio.



3247

Historical Archive, 1954

Famiglia di lampade da terra e da tavolo con diffusore in vetro soffiato bianco satinato e struttura in metallo nichelato.

Family of floor and table lamps with diffuser in frosted white blown glass and structure in nickel-plated metal.

Famille de lampadaires et de lampes de table avec diffuseur en verre soufflé blanc satiné et structure en métal nickelé.

Eine Familie von Boden- und Tischleuchten mit Diffusor aus weißem mundgeblasenem Opalglas und Struktur aus vernickeltem Metall.

Familia de lámparas de pie y de sobremesa con difusor de vidrio soplado blanco satinado y estructura de metal niquelado.



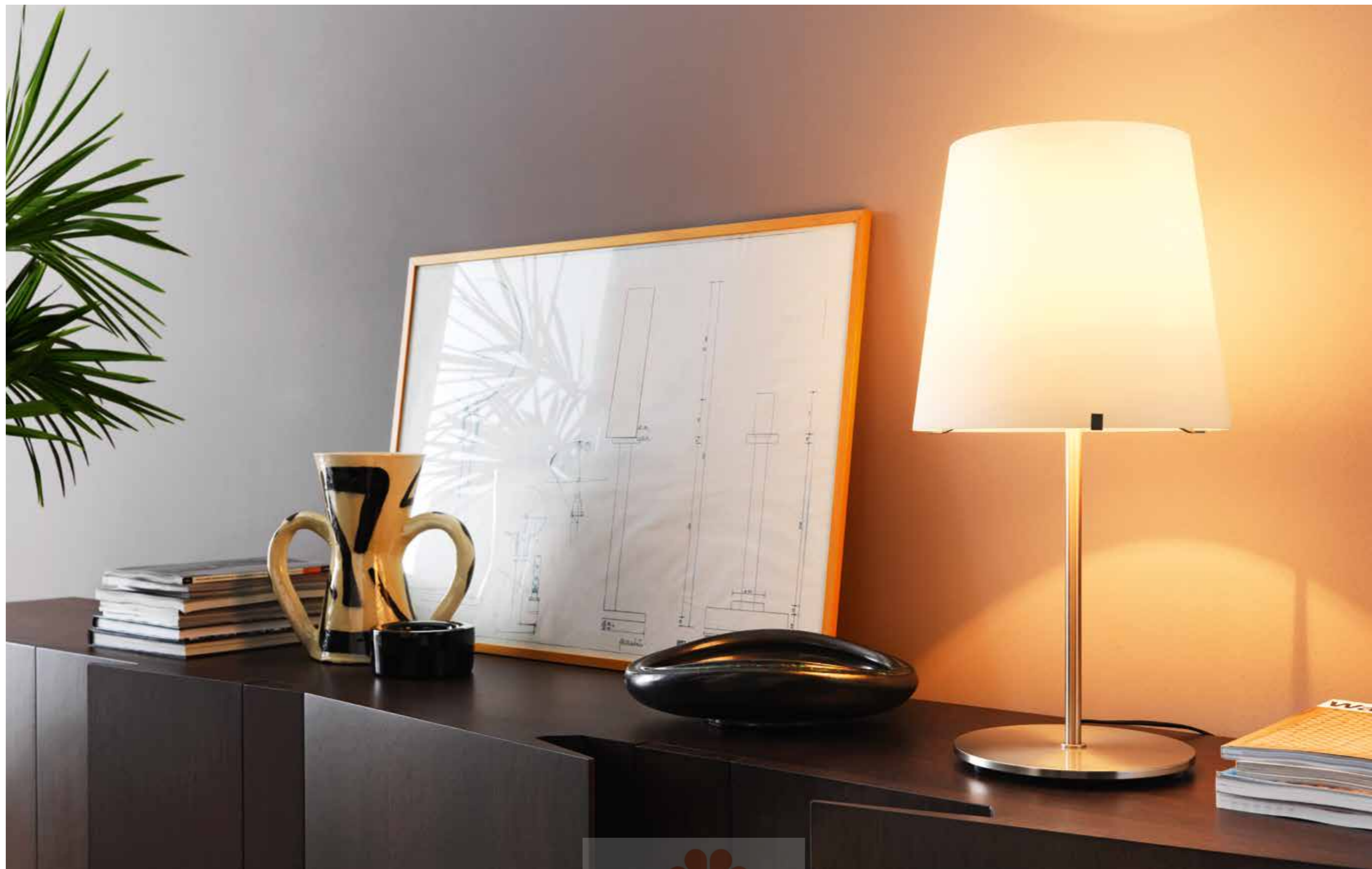

ALBEDO

Studio Drift, 2013

Lampada dalla forte presenza scenica che riproduce, in modo poetico, la forma di un bellissimo fiore. Leggera e immateriale, Albedo ha una forma elegante e raffinata. Il diffusore in tessuto viene tagliato al laser e poi piegato e cucito creando forme sfaccettate inedite. Lavabile in lavatrice.

A suspension lamp with big impact in a poetical rendering of a beautiful flower shape. Lightweight and immaterial, Albedo is elegant and refined. The fabric diffuser is laser cut and then pleated and sewn to create unusual faceted effects. Easy to dismantle and machine washable.

Lampe à la forte présence décorative qui reproduit avec poésie la forme sublime d'une fleur. Légère et immatérielle, Albedo a une forme élégante et raffinée. Le diffuseur est réalisé avec un tissu découpé au laser puis plié et cousu de manière à créer des formes à facettes inédites. Facile à démonter, il se lave en machine.

Pendelleuchte mit starkem Effekt, die auf poetische Weise die Form einer wunderschönen Blume reproduziert. Leicht und immateriell, hat Albedo eine elegante und raffinierte Form. Der Stoffdiffusor wird lasergeschnitten, dann gebogen und zusammengenäht und entfaltet sich facettenförmig. Er kann leicht abmontiert und in der Waschmaschine gewaschen werden.

Lámpara de fuerte presencia escénica que reproduce, de modo poético, la forma de una bellísima flor. Ligera e inmaterial, Albedo posee una forma elegante y refinada. El difusor de tejido está cortado con láser, plegado y cosido creando formas geométricas complejas e inéditas. Fácilmente desmontable y lavable lavadora.





AMAX

Charles Williams, 2003

Interpretazione extralarge del classico paralume FontanaArte, Amax è una famiglia di lampade da sospensione e da terra, disponibile sia nella versione da interno che in quella da esterno. La sospensione prevede, nelle misure più grandi, un disco di chiusura inferiore che copre la vista delle sorgenti luminose.

Als extragroße Interpretation des klassischen FontanaArte-Lampenschirms ist Amax eine Familie von Pendel- und Bodenleuchten, erhältlich sowohl in der Version für innen als auch für außen. Die Pendelleuchte hat optional bei den größeren Maßen eine untere Verschlusscheibe, die die Sicht auf die Leuchtmittel verdeckt.

Extra-large interpretation of the classic FontanaArte lampshade, Amax is a family of suspension and floor lamps, available in both indoor and outdoor versions. For the larger sizes, the hanging lamp has a lower disc that covers and hides the light sources from view.

Interpretación extra large de la clásica pantalla FontanaArte, Amax es una familia de lámparas de techo o de pie disponible tanto en la versión de iluminación interior como exterior. En las medidas más grandes, la versión de techo incluye un disco de cierre inferior que cubre la vista de las fuentes luminosas.

Interprétation « extra large » de l'abat-jour FontanaArte classique. Amax est une famille de suspension et lampadaires, disponibles en version intérieure ou extérieure. Pour les plus grande tailles, un disque de fermeture inférieur est proposé dans le but de masquer les sources lumineuses.





ANANAS

Vico Magistretti, 1999

Lampada da parete dal design senza tempo con diffusore in vetro bianco o ambra e vetro di chiusura inferiore temperato e sabbiato. A seconda di come viene installata, Ananas produce una emissione luminosa diffusa e indiretta verso l'alto o verso il basso.

Wall lamp with timeless design and diffuser in white or amber glass and sandblasted tempered glass bottom cover. Ananas produces diffused, indirect up- or down-lighting, depending on how it is installed.

Applique au design intemporel avec diffuseur en verre blanc ou ambre et verre de fermeture inférieur trempé et sablé. Ananas produit une lumière diffuse et indirecte vers le haut ou vers le bas, selon l'installation choisie.

Wandleuchte mit zeitlosem Design mit Diffusor aus weißem oder bernsteinfarbenem Glas und unteres getempertes und sandgestrahltes Verschlussglas. Ananas erzeugt eine diffuse und indirekte Lichtausstrahlung nach oben oder nach unten, je nachdem wie sie installiert wird.

Lámpara de pared de diseño atemporal con difusor de vidrio blanco o ámbar y vidrio de cierre inferior templado y arenado. Ananas produce una emisión luminosa difusa e indirecta hacia arriba o hacia abajo, dependiendo del modo en que se instala.

Technical data pag. 378

- Amber
- White



ASHANGHAI

Max Ingrand, 1955

Questa elegantissima lampada da tavolo è firmata Max Ingrand e il suo disegno risale al 1955, periodo in cui il maestro francese ricopriva in FontanaArte il ruolo di direttore artistico. Giunti in ottone cromato tengono assieme cinque tubi in vetro borosilicato trasparente che, in un gioco di intersezioni, sorreggono la lampada. Il diffusore superiore è in vetro soffiato incamiciato bianco acidato.

This extremely elegant table lamp was designed by Max Ingrand in 1955, during the period when this French maestro was artistic director at FontanaArte. Joints in chromed brass hold together five tubes in clear borosilicate glass that form a series of intersections supporting the lamp. The top diffuser is in white acid-etched cased blown glass.

Cette lampe de table très élégante, signée Max Ingrand, a été dessinée en 1955, quand le maître designer français occupait chez FontanaArte le poste de directeur artistique. Des joints en laiton chromé assemblent cinq tubes en verre borosilicate transparent qui, dans un jeu d'intersections, soutiennent la lampe. Le diffuseur supérieur est en verre soufflé plaqué blanc et dépoli.

Diese hochelegante Tischleuchte wurde von Max Ingrand entworfen und ihr Design geht auf das Jahr 1955 zurück, eine Zeit, in der der französische Meister bei FontanaArte die Rolle des Art Direktors innehatte. Verchromte Messinggelenke halten fünf Rohre aus transparentem Borosilikatglas zusammen, die in einem Spiel aus Schnittstellen die Leuchte stützen. Der obere Diffusor ist aus mundgeblasenem, weißem, geätztem Triplexglas.

Esta elegantísima lámpara de sobremesa lleva la firma Max Ingrand. Su diseño se remonta al año 1955, periodo en el que el maestro francés ocupaba el cargo de director artístico en FontanaArte. Juntas de latón cromado mantienen unidos los cinco tubos de vidrio borosilicato transparente que sostienen la lámpara con un juego de intersecciones. El difusor superior es de vidrio soplado doble de color blanco, tratado al ácido.





A TOMIC

Paolo Zani, 2003

Lampada a sospensione con diffusore in vetro soffiato bianco opalino e montatura in ottone cromato. Disponibile in due misure.

Suspension lamp with diffuser in white opaline blown glass and frame in chromed brass. Available in two sizes.

Suspension avec diffuseur en verre soufflé blanc opalin et structure en laiton chromé. Déclinée sous deux formats.

Zugpendelleuchte mit Diffusor aus opalweißem mundgeblasenem Glas und Halterung aus verchromtem Messing. Erhältlich in zwei Größen.

Lámpara de techo con difusor de vidrio soplado blanco opalino y montura de latón cromado. Disponible en dos medidas.





AUREA

Denis Santachiara, 2005

La sorgente luminosa, nascosta fra i due paralumi, uno esterno in alluminio verniciato e uno interno in metacrilato bianco che diffonde la luce, produce un'emissione luminosa diffusa e morbida.

Die Leuchtquelle ist zwischen den beiden Schirmen verborgen: ein äußerer aus lackiertem Aluminium und ein innerer aus weißem Methacrylat, der das Licht verbreitet und eine diffuse und weiche Lichtausstrahlung erzeugt.

The light source is hidden between the two lampshades: an external one in painted aluminum and an internal one in white methacrylate that produces soft diffused lighting.

La fuente luminosa está escondida entre las dos pantallas: una externa de aluminio pintado y otra interna de metacrilato blanco que difunde la luz generando una emisión luminosa difusa y suave.

La source lumineuse est dissimulée entre l'abat-jour et le diffuseur intérieur : un abat-jour extérieur en aluminium laqué et diffuseur intérieur en méthacrylate blanc qui produit une émission lumineuse douce et diffuse.

- Anthracite grey
- Gold
- Grey
- White

Technical data pag. 380

ADI Design Index 2006



AVICO

Charles Williams, 2006

Lampada a sospensione dal grande impatto scenico grazie ai due diametri disponibili (da 120 e 160 centimetri). Diffusore in polietilene nei colori bianco, nero e su richiesta anche argento e oro. Interno sempre bianco. Disponibile anche nella versione outdoor. Un disco di chiusura inferiore che copre la vista delle sorgenti luminose è venduto come accessorio.

Pendelleuchte mit großer szenischer Wirkung, dank der großen Abmessungen, erhältlich mit den beiden Durchmessern von 120 und 160 cm. Diffusor aus Polyethylen in den Farben Weiß, Schwarz und, auf Anfrage, auch Silber und Gold. Inneres stets weiß. Erhältlich auch in der Version für den Außenbereich. Eine untere Verschlusscheibe, die den Blick auf die Leuchtquellen verdeckt, wird als Zubehör verkauft.

Big-impact suspension lamp, spectacular thanks to its large sizes, available in 120 and 160 centimetre diameters. Polyethylene diffuser in white, black and, on request, also in silver and gold. White inside for all versions. Also available in an outdoor version. A lower disc that covers and hides the light sources is sold as an accessory.

Lámpara de techo de gran impacto escénico gracias a las grandes dimensiones disponibles para los dos diámetros, 120 y 160 centímetros. Difusor de polietileno en los colores blanco, negro y, a pedido, plata y oro. Interior siempre blanco. Disponible también en versión para exteriores. El disco de cierre inferior que cubre la vista de las fuentes luminosas está disponible como accesorio.

Suspension à forte présence décorative grâce à ses 2 grandes dimensions disponibles de 120 et 160 centimètres. Diffuseur en polyéthylène blanc ou noir, sur demande, argent et or. Intérieur toujours blanc. Également disponible en version outdoor. Un disque de fermeture inférieur, qui cache les sources lumineuses, est disponible en option.





BIANCA

Matti Klenell , 2015

Bianca è una famiglia di apparecchi di illuminazione provvisti di un diffusore in vetro incamiciato di colore bianco latte, soffiato a fermo con finitura satinata. La decorazione superficiale del diffusore è caratterizzata da una serie ordinata di leggeri e delicati solchi che, sul bianco volume del vetro, ricordano delle piccole impronte sulla neve fresca.

Bianca is a family of luminaires equipped with a fixed-mould blown cased glass diffuser with a milky white satin finish. The decoration on the diffuser surface features an orderly series of shallow delicate grooves etched into the white glass, yielding an effect resembling small footprints on fresh snow.

Bianca est une famille de luminaires équipés d'un diffuseur en verre oublé blanc laiteux, soufflé fixe avec finition satinée. La décoration en surface du diffuseur est constituée d'une série régulière de sillons légers et délicats qui, en se détachant sur le volume blanc du verre, évoquent de petites empreintes dans la neige fraîche.

Bianca ist eine Leuchtenfamilie, deren Schirme aus festgeblasenem Glas bestehen und mit einer milchweißen Lackierung und satiniertem Finish versehen sind. Die Oberfläche des Lampenschirms ist mit leichten und zarten Rillenmustern verziert, die auf dem Weiß des Glases an kleine Spuren auf frischem Schnee erinnern.

Bianca es una familia de lámparas iluminación provistas de un difusor de vidrio encamisado color opalino, soplado fijo con acabado satinado. La decoración superficial del difusor se caracteriza por una serie ordenada de ligeros y delicados surcos que, sobre el blanco volumen del vidrio, recuerdan pequeñas huellas sobre la nieve fresca.





BIANCA

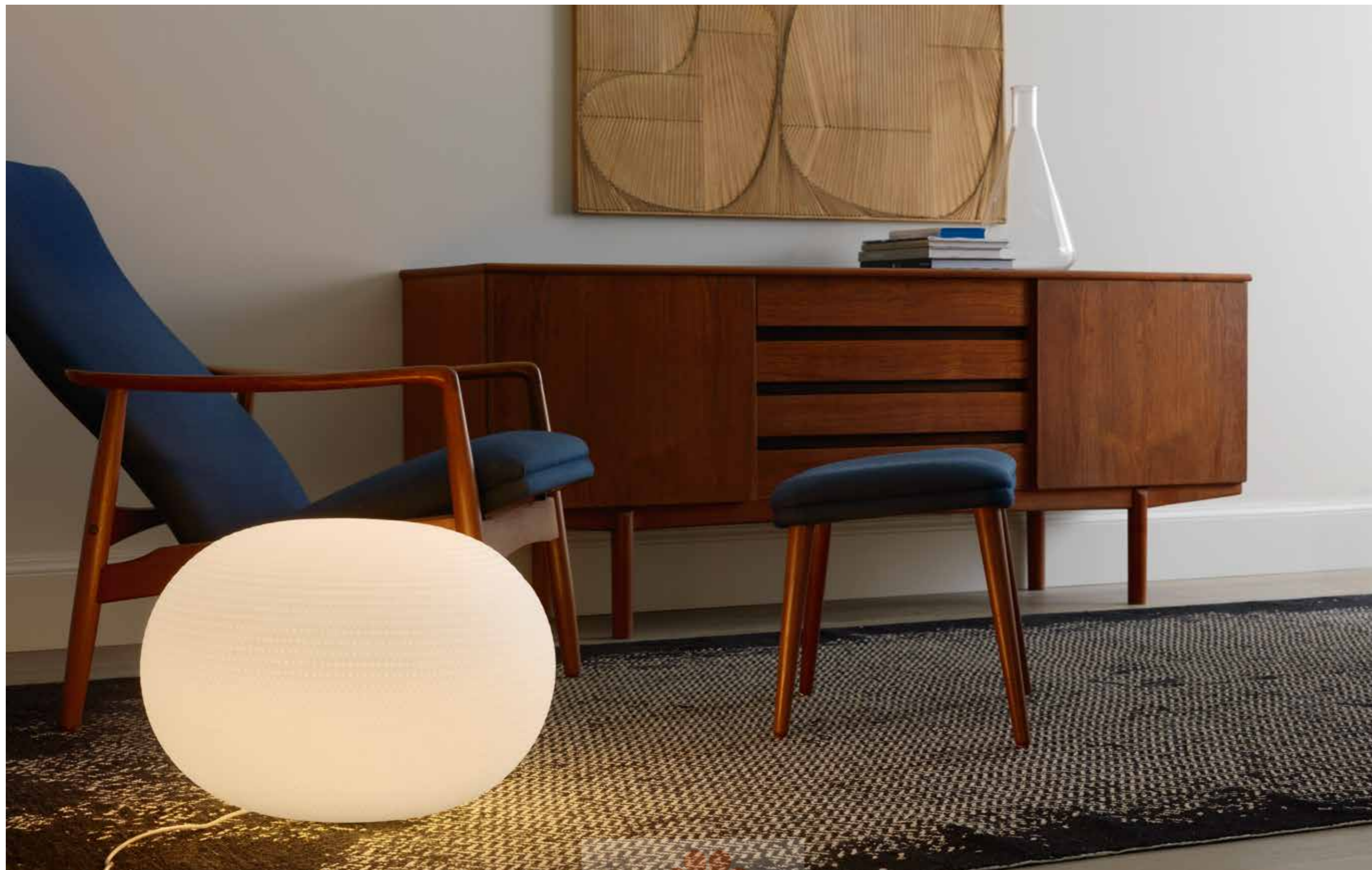





BIANCA



BIANCA

BILIA

Gio Ponti, 1931

Un cono e una sfera: due forme geometriche essenziali e riconoscibili. Una composizione semplice che si arricchisce grazie allo straordinario equilibrio delle proporzioni e all'eleganza discreta dei materiali non riflettenti: il diffusore è in vetro soffiato satinato, la montatura in metallo nichelato spazzolato.

Ein Kegel und eine Kugel: zwei wesentliche und erkennbare geometrische Formen. Eine einfache Komposition, die von dem wunderbaren Gleichgewicht der Proportionen und der dezenten Eleganz der nicht-reflektierenden Materialien bereichert wird. Der Diffusor besteht aus mundgeblasenem Opalglas, das Gestell ist aus vernickeltem und gebürstetem Metall.

A cone and a sphere: two essential, recognizable geometric shapes. An unpretentious composition, enriched by the extraordinary balance of its proportions and the stylish discretion of non-reflective materials: the diffuser is in frosted blown glass, the frame in brushed nickel-plated metal.

Un cono y una esfera: dos formas geométricas esenciales y reconocibles. Una composición simple embellecida por el extraordinario equilibrio de sus proporciones y por la discreta elegancia de sus materiales no reflectantes: el difusor es de vidrio soplado satinado y la montura de metal niquelado cepillado.

Un cône et une sphère : deux formes géométriques essentielles et identifiables. Une composition simple, qu'enrichissent l'extraordinaire équilibre des proportions et l'élégance discrète des matériaux non réfléchissants : le diffuseur est réalisé en verre soufflé satiné et la structure en métal nickelé brossé.



BIS, TRIS

Historical Archive, 1950

Progettate nel 1950, le lampade da tavolo Bis e Tris mantengono intatta la loro forma moderna, sia nella versione con montatura in ottone lucido e coppa in vetro opale nero (Bis), che in quella con montatura in metallo cromato e coppa in vetro sabbata e verniciata bianca internamente (Tris).

Die 1950 entworfenen Tischleuchten Bis und Tris behalten unbeeindruckt ihre moderne Form bei, und zwar sowohl in der Ausführung mit glänzendem Messingfuß und Schale aus schwarzem Opalglas (Bis) als auch in der mit verchromtem Metallfuß und Schale aus sandgestrahltem und auf der Innenseite weiß lackiertem Glas (Tris).

Designed in 1950, the Bis and Tris table lamps still feature their contemporary shape, both for the version with polished brass frame and bowl in black opal glass (Bis) and also for the one with chromed metal frame and bowl in sandblasted glass painted white inside (Tris).

Diseñadas en 1950, las lámparas de sobremesa Bis y Tris mantienen intacta su forma contemporánea, tanto en la versión con montura de latón brillante y copa de vidrio opalino negro (Bis) como en la de montura de metal cromado y copa de vidrio arenada y pintada blanca por dentro (Tris).

Dessinées en 1950, les lampes de table Bis et Tris conservent une forme contemporaine intacte, dans la version avec structure en laiton brillant et coupelle en verre opale noire (Bis) comme dans la version avec structure en métal chromé et coupelle en verre sablé et laquée blanc à l'intérieur (Tris).



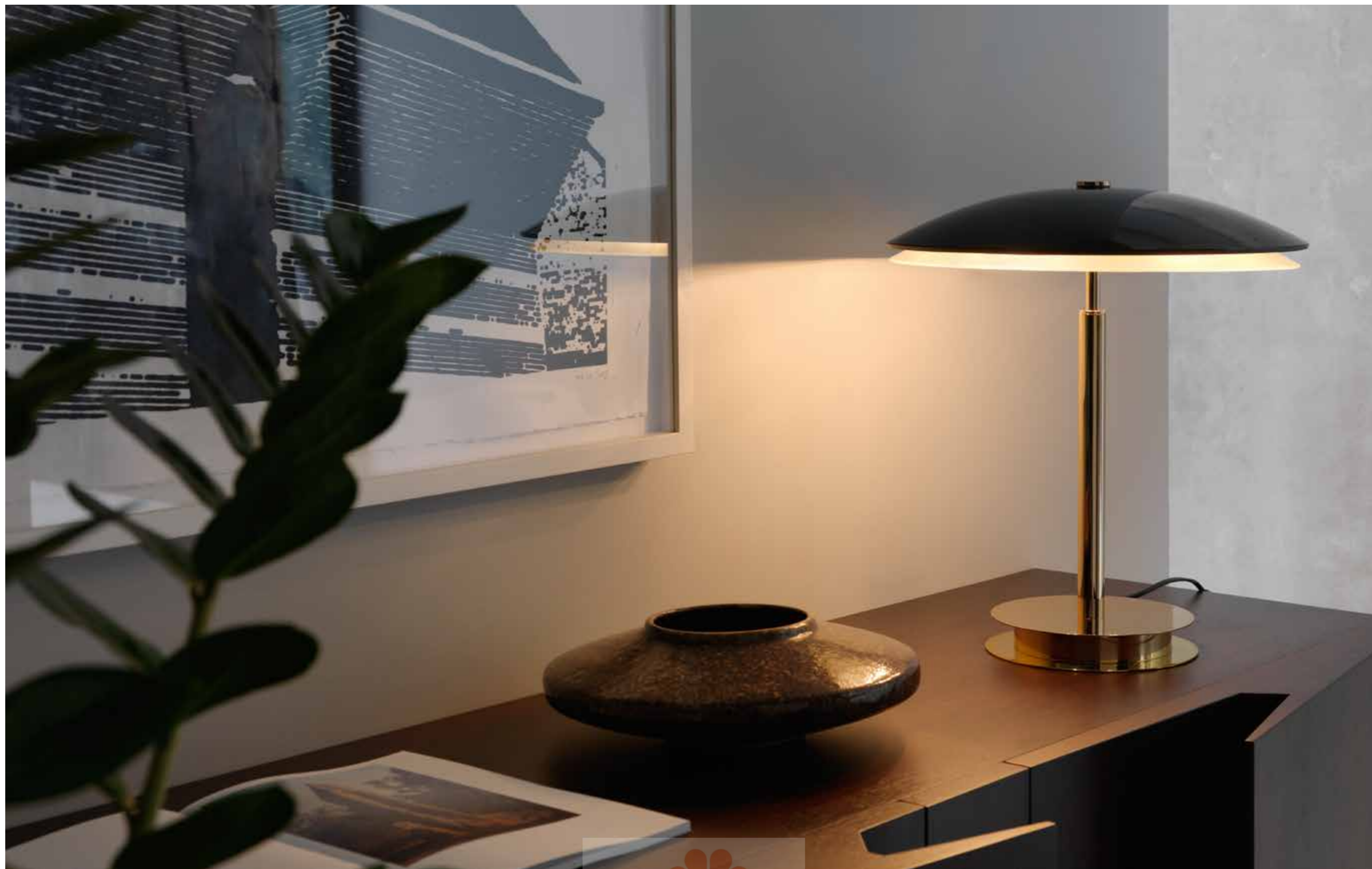

BLOM

Andreas Engesvik, 2013

Il nome deriva dalla forma della lampada che, dotata di pale simili a petali, ricorda appunto un fiore. La quantità di luce è regolabile grazie ai due petali che avvolgono dolcemente il diffusore e che ruotando sulla base, consentono di schermare il flusso luminoso, personalizzandolo a seconda delle esigenze.

Der Name kommt von der Form der Leuchte, die mit Blütenblättern ähnelnden Flügeln versehen ist und so an eine Blume erinnert. Die Lichtmenge ist dank der beiden Blütenblätter einstellbar, die den Diffusor zart einfassen und sich auf der Basis um 360° drehen lassen. Sie ermöglichen so eine Abschirmung des Lichtstroms und personalisieren ihn je nach Bedarf.

Its name comes from the shape of the lamp, similar to a flower due to its petal shaped blades. Light intensity can be adjusted thanks to the two petals that gently embrace the diffuser, rotating on the base to shield the glare depending on personal requirements.

Su nombre deriva de la forma de la lámpara que, dotada de palas similares a pétalos, recuerda precisamente la forma de una flor. La cantidad de luz puede regularse con los dos pétalos que envuelven dulcemente el difusor y que, girando sobre la base, permiten atenuar el flujo luminoso para personalizarlo en función de las exigencias.

Elle doit son nom à sa forme dont les éléments, semblables à des pétales, évoquent une fleur. Le degré de lumière est réglable grâce aux deux pétales qui enveloppent doucement le diffuseur et qu'il suffit de tourner sur la base pour masquer ou personnaliser le flux lumineux selon ses exigences.

- Black
- Grey
- Green
- Green
- Red
- Yellow
- White

Technical data pag. 388

Reddot Design Award 2014





BLOM

BOLLA

Harry&Camila, 2003

Questa lampada a sospensione si chiama Bolla perché il suo diffusore in vetro soffiato trasparente ha un effetto iridescente che ricorda l'effetto delle bolle di sapone. È disponibile in due forme.

Diese Pendelleuchte trägt den Namen Bolla, weil ihr Diffusor aus transparentem und mundgeblasenem Glas einen Regenbogeneffekt hat, der an den Effekt von Seifenblasen erinnert. Sie ist in zwei Formen und Größen erhältlich.

This suspension lamp is called Bolla because its clear blown glass diffuser has an iridescent appearance that recalls the effect of soap bubbles. It is available in two shapes and sizes.

Lámpara con difusor de vidrio soplado transparente de efecto iridiscente que recuerda el efecto de las pompas de jabón. Está disponible en dos formas y tamaños.

Cette suspension se nomme Bolla pour son diffuseur en verre soufflé transparent produisant un effet iridescent qui évoque une bulle de savon. Disponible en deux formes et formats.







BONNET

Odo Fioravanti, 2014

Bonnet reinterpreta il concetto di illuminazione indiretta. La parte superiore del corpo accoglie e nasconde una piccola e potentissima sorgente a Led il cui fascio luminoso si direziona prevalentemente verso la parete superiore ed il soffitto. Una lente recupera la luce parassita, normalmente persa, indirizzandola anche verso il basso.

Bonnet interpretiert das Konzept der indirekten Beleuchtung neu. Der obere Teil des Leuchtenkörpers enthält und verbirgt eine kleine und sehr potente Led-Lichtquelle, deren Lichtstrahl vorwiegend auf den oberen Teil der Wand und auf die Decke gerichtet ist. Eine Linse gewinnt die Überstrahlung, die normalerweise verloren geht, zurück und richtet sie auch nach unten.

Bonnet reworks the concept of indirect lighting. The top part conceals a small yet very powerful Led source whose ray of light is mainly directed upwards onto the wall above and ceiling. A lens recuperates the parasite light that is normally lost, directing it towards the floor.

Bonnet reinterpreta el concepto de iluminación indirecta. La parte superior del cuerpo aloja y oculta una pequeña y potentísima fuente led cuyo haz de luz se orienta principalmente hacia la pared superior y hacia el techo. Una lente recupera la luz parásita, que normalmente se pierde, dirigiéndola hacia abajo.

Bonnet réinterprète le concept d'éclairage indirect. La partie supérieure du corps contient et dissimule une petite source à Led, très puissante, dont le faisceau lumineux est principalement orienté vers le haut du mur et vers le plafond. Un diffuseur récupère la lumière parasite, normalement perdue, pour l'orienter aussi vers le bas.



BRUCO

Vico Magistretti, 2003

La sorgente luminosa illumina le due sfere in vetro soffiato di questa piccola lampada da parete disegnata da Vico Magistretti.

The light source illuminates the two spheres in blown glass that form this little wall lamp designed by Vico Magistretti.

La source lumineuse éclaire les deux sphères en verre soufflé qui composent cette petite applique dessinée par Vico Magistretti.

Die Lichtquelle erleuchtet die beiden Kugeln aus mundgeblasenem Glas, aus denen diese kleine, von Vico Magistretti entworfene Wandleuchte zusammengestellt ist.

La fuente luminosa ilumina las dos esferas de vidrio soplado que componen esta pequeña lámpara de pared diseñada por Vico Magistretti.



CHANDELIER

David Chipperfield, 2004

Si ispira ai lampadari della corte di re Artù lo scenografico lampadario disegnato da David Chipperfield. Disponibile in due colori, nella versione singola o doppia con due cerchi concentrici, illumina con classe ed eleganza qualsiasi ambiente, anche quello più moderno e minimale.

Der szenographische Leuchter, der von David Chipperfield entworfen wurde, inspiriert sich an den Kronleuchtern am Hof König Arthurs. In zwei Farben erhältlich, in der Einzel- oder Doppelausführung mit zwei konzentrischen Kreisen erleuchtet er mit Eleganz und Klasse jedes Ambiente, auch wenn es sehr modern und minimalistisch ist.

This spectacular lamp designed by David Chipperfield is inspired by those at the court of King Arthur. Available in two colors, in a single or double version with two concentric circles, it is a classy elegant lighting solution for any setting, even the most modern and minimal.

Esta escenográfica lámpara de suspensión diseñada por David Chipperfield se inspira en los candelabros de la corte del rey Arturo. Disponible en dos colores, en versión individual o doble con dos discos concéntricos, ilumina con clase y elegancia cualquier ambiente, incluso los más modernos y minimalistas.

David Chipperfield qui est à l'origine de ce luminaire à forte présence décorative s'est inspiré des lampadaires de la cour du roi Arthur. Disponible en deux couleurs, en version simple ou double avec deux cercles concentriques. Elle éclaire avec classe et élégance chaque pièce, y compris l'espace le plus moderne et minimal.

Technical data pag. 393

- Black
- Gray





CHESHIRE

GamFratesi, 2013

Riflette l'impronta nordica dello studio nella semplicità dell'estetica e della funzionalità. La calotta è di policarbonato opalino per favorire l'emissione diffusa; colorato per diffondere la luce verso il basso nella versione da tavolo e da terra oppure verso l'alto nella versione sospesa.

It echoes the studio's Nordic imprint in its simplicity and functional aspects. The opaline polycarbonate diffuser ensures soft lighting, while the colored one spreads the light downwards in the table and floor versions or upwards in the hanging model.

La lampe reflète le style nordique du cabinet dans la simplicité de l'esthétique et de la fonctionnalité. Le diffuseur est en polycarbonate opalin pour favoriser l'émission diffuse, coloré pour orienter la lumière vers le bas, dans la version lampe de table et lampadaire, ou vers le haut dans la version suspension.

Reflektiert die nordische Ausrichtung des Studios in der Einfachheit von Ästhetik und Funktionalität. Der Schirm ist aus opalmilchweiß durchleuchtendem Polycarbonat, um eine diffuse Lichtausstrahlung zu begünstigen; er ist gefärbt, um das Licht in der Tisch- und Bodenausführung nach unten oder (in der Pendelversion) nach oben auszustrahlen.

Refleja el carácter nórdico del estudio en la sencillez de su estética y de su funcionalidad. El difusor puede ser de policarbonato opalino, para favorecer una emisión difusa, o de colores, para difundir la luz hacia abajo en la versión de sobremesa y de pie o hacia arriba en la versión de techo.

- Black
- Green
- Opaline
- White

Technical data pag. 395







CHESHIRE



CHIARA

FontanaArte Design Lab, 2003

Una forma classica in una misura extra small, Chiara ha il diffusore in vetro soffiato e la base in metallo di forma quadrata.

A classic shape in an extra small size, Chiara has a blown glass diffuser and square metal base.

Chiara, qui présente une forme classique dans un format « extra small », se caractérise par un diffuseur en verre soufflé et une base en métal carrée.

Als eine klassische Form in der Größe Extra Small ist der Diffusor der Leuchte Chiara aus mundgeblasenem Glas und die Metallbasis quadratisch.

Una forma clásica en una medida extra small: Chiara se presenta con difusor de vidrio soplado y base de metal de forma cuadrada.



CLOCHE

Historical Archive, 2014 edition

Cloche è la riedizione di Pudding, la lampada a sospensione dell'Archivio Storico FontanaArte, disegnata nel 1995. Proposta in una gamma di colori morbidi e contemporanei: grigio chiaro e scuro, giallo senape e bianco traslucido. Quest'ultima, quando accesa, fa trasparire la luce creando un effetto magico che esalta il design del diffusore.

Cloche ist die Neuauflage von Pudding, der Pendelleuchte aus dem Historischen FontanaArte-Archiv, die 1995 entworfen wurde. Sie wird in einer weichen und modernen Farbpalette angeboten: Hell- und Dunkelgrau, Senfgeb und transluzentes weiß. Diese neueste Version lässt, wenn sie eingeschaltet ist, das Licht durchscheinen und schafft so eine magische Wirkung, die das Design des Diffusors hervorhebt.

Cloche is the makeover of Pudding, the hanging lamp from the FontanaArte Historic Archive designed in 1995. It comes in a range of soft, contemporary colors: pale and dark grey, mustard yellow and translucent white. When this latter version is switched on, the light creates a magical effect that enhances the design of the diffuser.

Cloche es la reedición de Pudding, la lámpara de techo del Archivo Histórico FontanaArte diseñada en 1995. Se propone en una gama de colores suaves y contemporáneos: gris claro y oscuro, amarillo mostaza y blanco translúcido. Cuando está encendida, esta última versión filtra la luz creando un efecto mágico que resalta el diseño del difusor.

Cloche est une réédition de Pudding, la suspension dessinée en 1995, qui appartient aux archives historiques de FontanaArte. Elle est proposée dans une gamme de coloris doux et contemporains : gris clair et foncé, jaune moutarde et blanc translucide. Dans cette dernière finition, la lampe, une fois allumée, fait apparaître la lumière, créant ainsi un effet magique qui souligne le design du diffuseur.

- Dark grey
- Mustard yellow
- Pale grey
- Translucent white

Technical data pag. 397







CORRUBEDO

David Chipperfield, 2005

Corrubedo è una lampada da parete dalla rigorosa linea geometrica che si installa con la fonte luminosa rivolta verso l'alto o verso il basso a seconda di dove si desidera direzionare la luce. È disponibile con lo schermo frontale bianco oppure specchiato.

Corrubedo ist eine Wandleuchte mit einer rigorosen geometrischen Linie, die mit nach oben oder nach unten gerichteter Leuchtquelle installiert wird, je nachdem, wohin man das Licht orientieren möchte. Sie ist mit weißem oder Spiegel-Frontschirm erhältlich.

Corrubedo is a wall lamp with no-frills geometric lines that can be installed with the light source pointing either up or down, depending on where the beam of light is required. The front screen is available either in white or with mirror finish.

Corrubedo es una lámpara de pared de rigurosa línea geométrica que se instala con la fuente luminosa orientada hacia arriba o hacia abajo, según la dirección deseada. Está disponible con la pantalla frontal blanca o en acabado espejo.

Corrubedo est une applique à la ligne géométrique rigoureuse qui s'installe avec sa source lumineuse vers le haut ou le bas selon l'orientation de la lumière voulue et la hauteur d'installation. Elle est disponible avec façade blanche ou miroir.



CUPOLA

Historical Archive, 1979

Lampada a sospensione dal design senza tempo particolarmente adatta per un'illuminazione diretta su ogni tipo di piano. È disponibile in due misure.

Pendelleuchte mit zeitlosem Design, besonders für eine direkte Beleuchtung auf jeder Art von Fläche geeignet. Sie ist in zwei Größen erhältlich.

Suspension lamp with timeless design, particularly suited for direct lighting of any kind of surface. It is available in two different sizes.

Lámpara de techo de diseño atemporal, particularmente adecuada para obtener una iluminación directa en todo tipo de superficies. Está disponible en dos medidas.

Suspension au design intemporel, particulièrement indiquée pour un éclairage direct sur tous les types de plan. Disponible en deux dimensions.



DARUMA

Sergio Asti, 1968

Esposta al Museum of Modern Art di New York, Daruma nasce nel 1968 su progetto di Sergio Asti. Composta da due elementi diffusori in vetro soffiato bianco lucido, è una lampada da tavolo la cui realizzazione è semplice e rigorosa: un vaso sferico sormontato da una piccola calotta. È disponibile in sei misure.

Daruma ist heute im Museum of Modern Art in New York ausgestellt und wurde 1968 von Sergio Asti entworfen. Sie setzt sich aus zwei Diffusor-Elementen aus weißem, mundgeblasenem und poliertem Glas zusammen und ist eine einfache und rigorose Tischleuchte: eine Kugelvase und eine darauf sitzende kleine Halbkugel. Sie ist in sechs Größen erhältlich.

On show at the Museum of Modern Art in New York, Daruma was produced in 1968 to a design by Sergio Asti. Comprising two diffuser elements in glossy white blown glass, this table lamp has simple, formal features: a spherical vase topped by a little lid. It is available in six different sizes.

Expuesta en el Museum of Modern Art de Nueva York, Daruma nace en 1968 a partir de un proyecto de Sergio Asti. Compuesta por dos elementos difusores de vidrio soplado blanco brillante, es una lámpara de sobremesa de simple y rigurosa realización: un jarrón esférico coronado por un pequeño casquete. Está disponible en seis medidas.

Exposée au Museum of Modern Art de New York, Daruma est née en 1968 d'un projet de Sergio Asti. C'est une lampe de table composée de deux éléments diffuseurs en verre soufflé blanc brillant, dont la réalisation est simple et rigoureuse: un vase sphérique surmonté d'une petite coupe. Disponible en six dimensions.

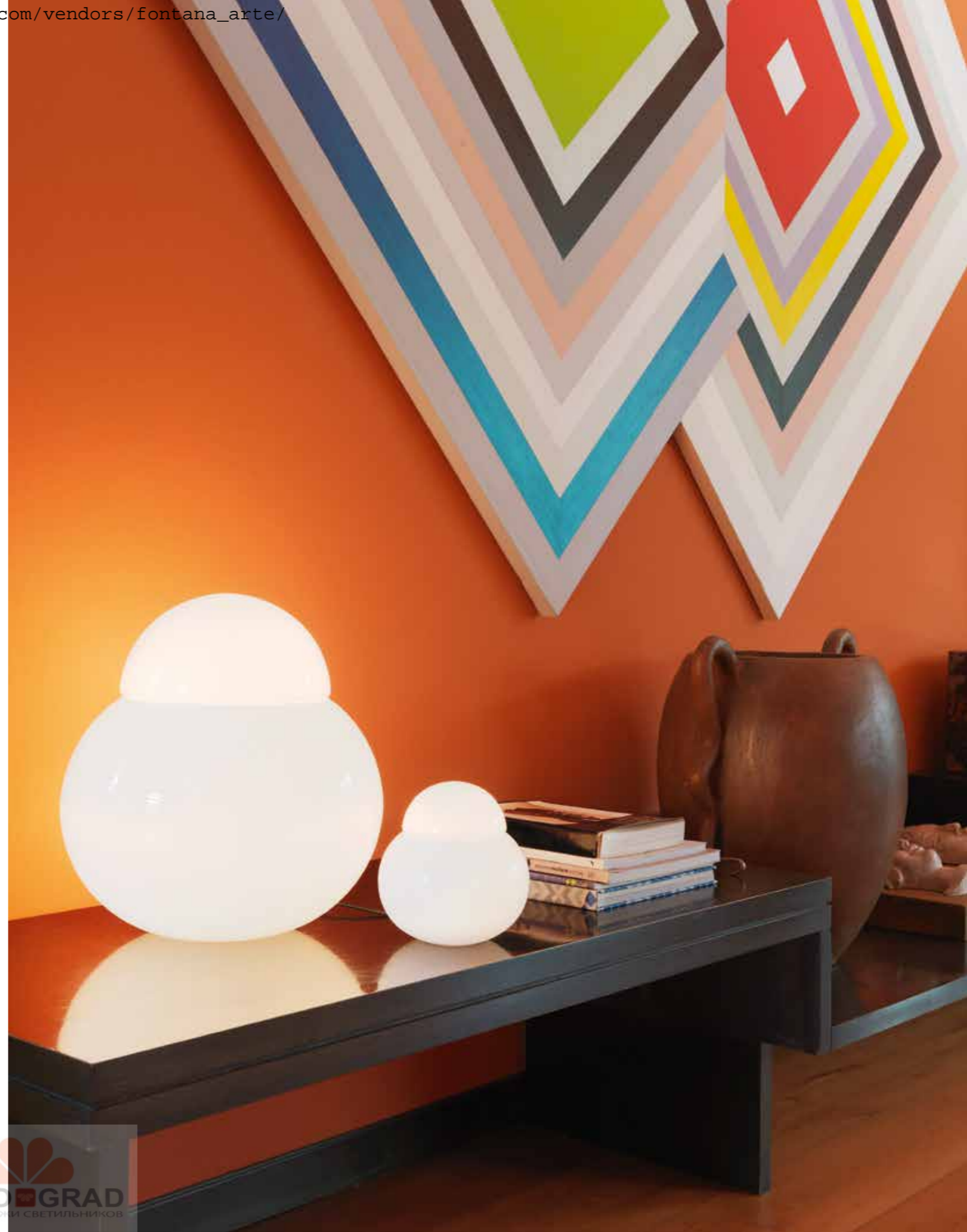

DRUM

Franco Raggi, 2005

Collezione dal design puro ed elegante in una totale armonia di materiali: vetro borosilicato trasparente per lo stelo, vetro soffiato bianco acidato per il diffusore e acciaio lucido per la base.

Design pur und ein harmonisches Zusammenleben von Materialien: Transparentes Borosilikatglas für den Stab, weißes, mundgeblasenes Ätzglas für den Diffusor und Glanzstahl für den Sockel.

Pure design and harmonious materials: clear borosilicate glass for the stem, white acid-etched blown glass for the diffuser and polished steel for the base.

Diseño puro y un conjunto armónico de materiales: vidrio borosilicato transparente en el pie, vidrio soplado blanco tratado al ácido en el difusor y acero brillante en la base.

Un design pur et un ensemble harmonieux de matériaux : verre borosilicate transparent pour la tige, verre soufflé blanc dépoli pour le diffuseur et acier brillant pour la base.



DUPLEX

Carlo Tamborini, 2000

Colore e trasparenza convivono mettendo in risalto tutta la tecnica del prodotto. Disponibile in due colori, Duplex è regolabile in altezza e produce una doppia emissione luminosa: diffusa e diretta verso il basso e verso l'alto.

Color and clearness team up to highlight all the technology in this product. Available in two colors, Duplex can be adjusted in height and produces light in two directions: diffused and direct downwards and upwards.

Couleur et transparence cohabitent pour mieux souligner toute la technicité du produit. Disponible en deux coloris, Duplex est réglable en hauteur et produit une double émission lumineuse : diffuse et directe vers le bas et vers le haut.

Farbe und Transparenz koexistieren und heben alle technischen Details des Produkts hervor. Erhältlich in zwei Farben, ist Duplex höhenverstellbar und erzeugt eine doppelte Lichtausstrahlung: diffus und direkt nach unten und nach oben.

Color y transparencia conviven resaltando toda la tecnicidad del producto. Disponible en dos colores, Duplex es regulable en altura y produce una doble emisión luminosa: difusa y directa, hacia abajo y hacia arriba.

Technical data pag. 401

- Red
- Satin

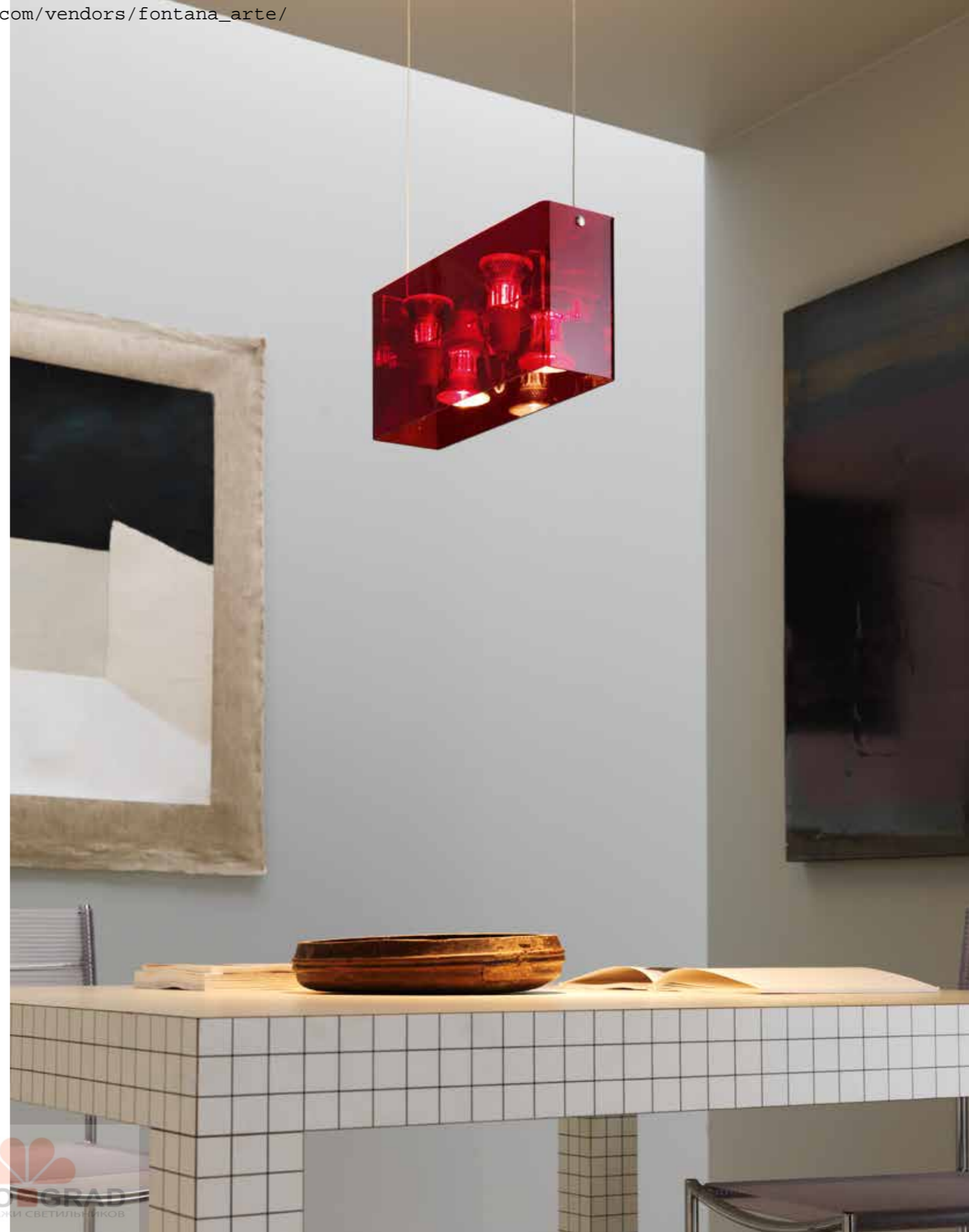

FALENA

Alvaro Siza, 1994

Leggerezza ed eleganza in questa famiglia di lampade disegnata da Alvaro Siza e disponibili nella versione da terra, tavolo e parete. Corpo e alette diffusori orientabili per una gestione totale della luce.

Leichtheit und Eleganz zeichnen diese Leuchtenfamilie aus, die von Alvaro Siza entworfen und in den Ausführungen für Boden, Tisch und Wand erhältlich ist. Das Halogenleuchtmittel ist von einer matten Pyrexglaskuppel umhüllt, Körper und Flügel der Diffusoren sind für ein komplettes Lichtmanagement orientierbar.

Lightness and elegance for this family of lamps designed by Alvaro Siza and available in floor, table and wall versions. Adjustable body and diffuser wings for complete management of light.

Ligereza y elegancia en esta familia de lámparas diseñada por Alvaro Siza y disponibles en versión de pie, de sobremesa y de pared. El cuerpo y las aletas difusoras orientables permiten gestionar totalmente la luz.

Légèreté et élégance distinguent cette famille de lampes dessinée par Alvaro Siza et disponibles dans les versions lampadaire, lampe de table ou applique. Corps et ailettes des diffuseurs orientables pour une gestion totale de la lumière.



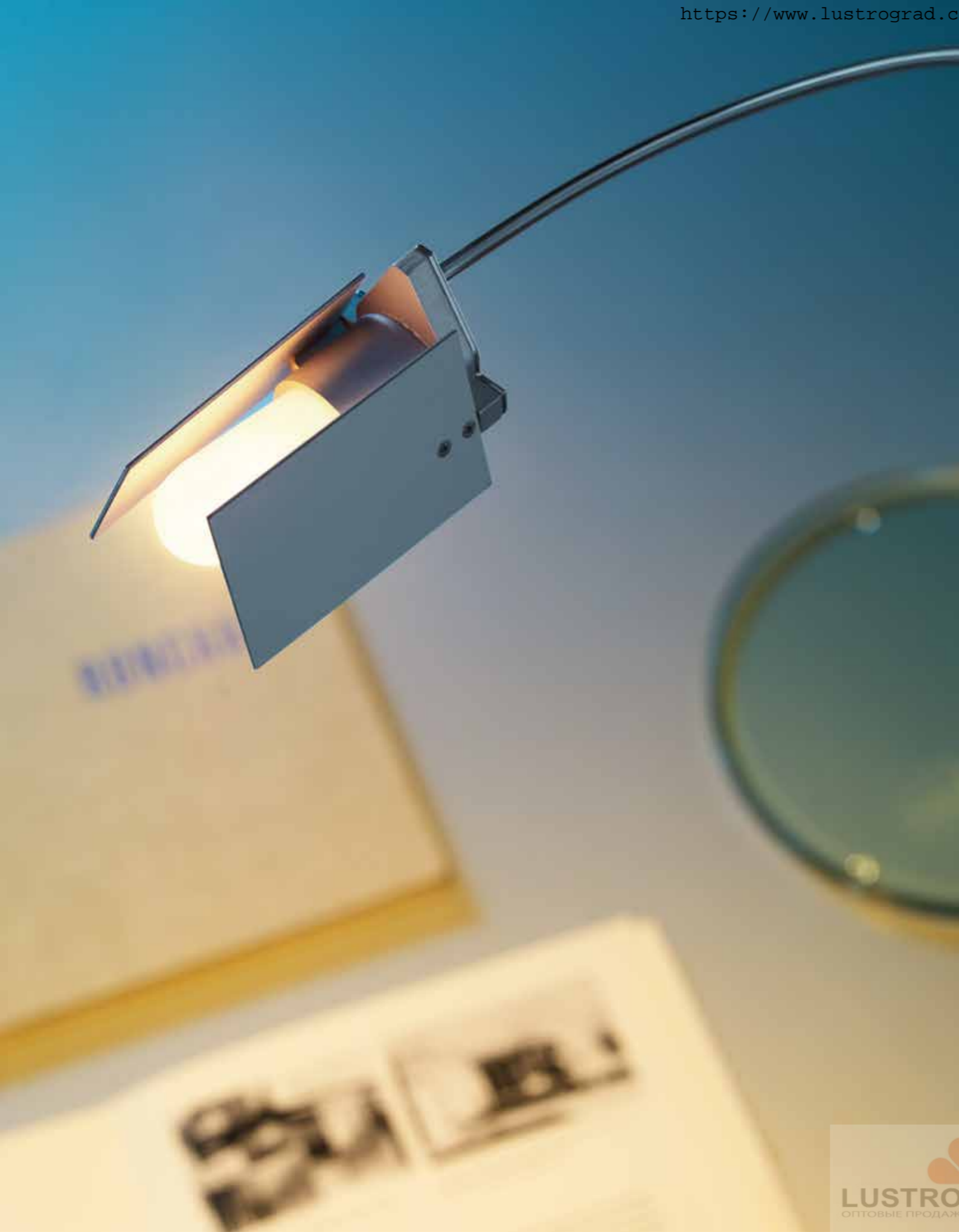

Wall



FLEX

Karim Rashid, 2015

Flex è una lampada da parete dalla forma iconica e minimale. In alluminio pressofuso è caratterizzante e rigorosa allo stesso tempo e irradia la luce verso l'alto e verso il basso come una sottile superficie galleggiante.

Flex is a wall lamp with an icon minimal shape. In die-cast aluminum it manages to deliver character and formality at one and the same time, radiating light both upwards and downwards like a fine floating surface.

Flex est une applique à la forme iconique et minimaliste. En aluminium moulé sous pression, est à la fois distinctif et rigoureux: il diffuse la lumière vers le haut et vers le bas comme une fine surface flottante.

Flex ist eine Wandleuchte mit einer ikonischen und minimalistischen Form. Sie ist aus Aluminiumdruckguss gleichzeitig prägend und streng. Flex strahlt das Licht direkt und indirekt aus wie eine filigrane schwebende Fläche.

Flex es una lámpara de pared de forma icónica y minimalista. Realizado en aluminio moldeado a presión, este objeto de carácter fuerte y riguroso a la vez irradia la luz hacia arriba o hacia abajo como una fina superficie flotante.

- White
- Blue
- Pink
- Black

Technical data pag. 403



FLÛTE, FLÛTE MAGNUM

Franco Raggi, 1999

Un cono di vetro alloggia il riflettore in alluminio cromato, sorretto da tre aste sottili in metallo. Equilibrio e leggerezza per questa famiglia di lampade disponibili nella versione da terra e parete per una emissione di luce indiretta e a sospensione, per una emissione di luce puntuale e diretta.

In einem Glaskegel befindet sich der Reflektor aus verchromtem Aluminium, der von drei Metallstützen gehalten wird. Gleichgewicht und Leichtigkeit bei dieser Lampenfamilie, in der Boden- und Wandausführung erhältlich, für eine indirekte Lichtausstrahlung, und als Pendelleuchte für eine präzise und direkte Lichtausstrahlung.

A glass cone holds the chromed aluminum reflector, supported by three slender metal rods. Equilibrium and lightness for this family of lamps available in floor and wall versions, for indirect light emission, and in a hanging version, for direct focused light.

Un cono de vidrio aloja el reflector de aluminio cromado, sostenido por tres barras finas de metal. Equilibrio y ligereza son las características distintivas de esta familia de lámparas disponibles en versión de pie o de pared, para emitir una luz indirecta, y de techo, para emitir una luz puntual y directa.

Un cône de verre contient le réflecteur en aluminium chromé, soutenu par trois fines tiges de métal. Cette famille de lampes, synonyme d'équilibre et de légèreté, est disponible dans les versions lampadaire et applique, pour une émission de lumière indirecte, et suspension, pour une émission de lumière ponctuelle et directe.

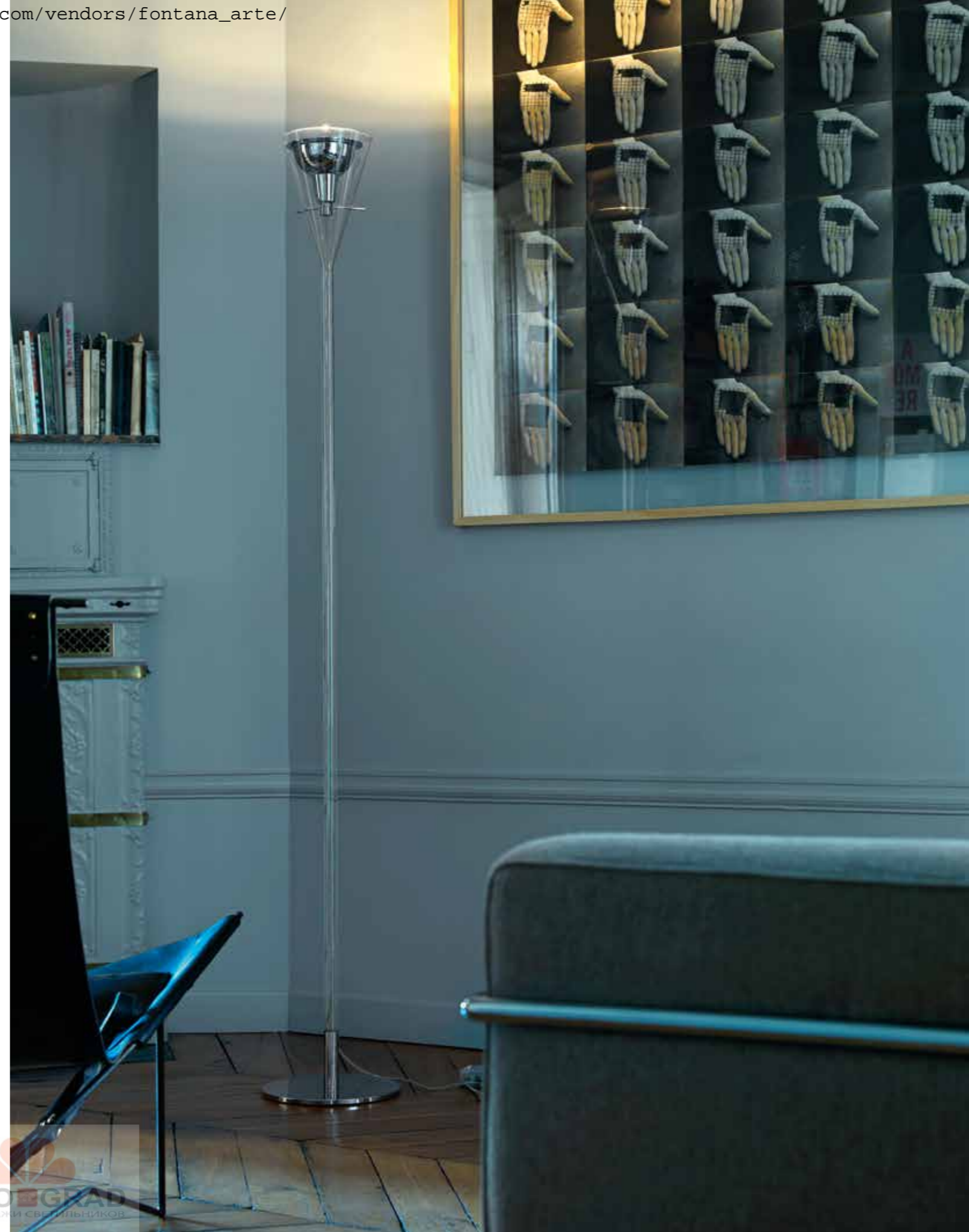





FLÔTE MAGNUM / FLÔTE

FONTANA

Max Ingrand, 1954

Icona intramontabile e oggetto di design senza tempo, rappresenta l'abat-jour per eccellenza. Una lampada preziosissima in vetro soffiato satinato bianco nata dall'arte dei maestri vetrai che rende omaggio al genio creativo di Max Ingrand.

An evergreen, timeless design icon, this is the lampshade par excellence. A fabulous lamp in frosted white blown glass, an example of the art of master glassmakers, it pays tribute to the creative genius of Max Ingrand.

Icône indémodable et objet de design intemporel, elle représente la lampe à abat-jour par excellence. Une lampe extrêmement raffinée en verre soufflé satiné blanc, chef-d'œuvre des maîtres verriers, qui rend hommage au génie créatif de Max Ingrand.

Unvergängliche Ikone und Objekt zeitlosen Designs, stellt sie die Tischleuchte par excellence dar. Eine sehr kostbare Leuchte aus weißem mundgeblasenem Opalglas, die aus der Kunst der Glasmeister entstand und eine Hommage an das kreative Genie von Max Ingrand ist.

Icono imperecedero y objeto de diseño atemporal, representa la lámpara de sobremesa por excelencia. Una elegantísima lámpara de vidrio soplado satinado blanco nacida del arte de los maestros vidrieros que rinde homenaje al genio creativo de Max Ingrand.







FONTANA TOTAL BLACK

Max Ingrand, 2014 edition

Un inedito Total Black realizzato nel 2014 per il 60° anniversario di Fontana. Una versione in vetro soffiato nero che, per la tecnica di lavorazione del vetro, rende la lampada ancora più pregiata.

Ein neues Total Black aus dem Jahre 2014 für den 60. Jahrestag von Fontana. Eine Ausführung aus schwarzem mundgeblasenem Glas, durch das die Leuchte mit ihrer Glasverarbeitungstechnik noch kostbarer wird.

An unusual Total Black produced in 2014 to mark the 60th anniversary of Fontana. The glass-working technique used for this black blown glass version makes the lamp even more exquisite.

Un inédito Total Black realizado en 2014 para el 60.° aniversario de Fontana. Una versión de vidrio soplado negro, tratado con una técnica que resalta su valor.

Une inédite version de couleur noire réalisée en 2014 pour le 60e anniversaire de la Fontana. Une version en verre soufflé noir d'une lampe que la technique de travail du verre rend encore plus précieuse.





FONTANA TOTAL BLACK

GIOVA

Gae Aulenti, 1964

Ibrido tra un vaso e una lampada, Giova segna l'esordio di Gae Aulenti nel campo dell'illuminazione d'autore. Una vera e propria scultura luminosa in vetro, disponibile in due misure.

Hybrid zwischen einer Vase und einer Leuchte markiert Giova das Debüt von Gae Aulenti auf dem Gebiet der Autorenbeleuchtung. Eine echte Lichtskulptur aus Glas, in zwei Größen erhältlich.

Half vase, half lamp, Giova marks Gae Aulenti's debut in the field of designer lighting. A veritable luminous sculpture in glass, available in two sizes.

Híbrido entre un jarrón y una lámpara, Giova marca el debut de Gae Aulenti en el campo de la iluminación de autor. Una auténtica escultura luminosa de vidrio, disponible en dos medidas.

Entre vase et lampe, Giova marque les débuts de Gae Aulenti dans le domaine de l'éclairage d'auteur. Une véritable sculpture lumineuse en verre, disponible en deux formats.





GLOBO DI LUCE

Roberto Menghi, 1968

Il vetro soffiato, nella finiture cromo e rame metallizzato, impreziosisce il paralume sferico di questa famiglia di lampade, disponibili nella versione da tavolo e, in tre diverse misure, nella versione a sospensione.

Blown glass, in chrome and metallic copper finishes, enhances the spherical lampshades of this family, available in a table version and three different sized suspension versions.

Le verre soufflé, dans les finitions chrome et cuivre métallisé, embellit l'abat-jour sphérique de cette famille de lampes, disponible en versions lampe de table et, en trois formats différents de suspension.

Das mundgeblasene Glas mit Chrom- und Kupfer-Metallic-Finish, verschönert den sphärischen Lampenschirm dieser Leuchtenfamilie, die in der Tischausführung und in drei verschiedenen Größen in der Pendelausführung erhältlich sind.

En los acabados cromo y cobre metalizado, el vidrio soplado embellece la pantalla esférica de esta familia de lámparas, disponibles en versión de sobremesa y, en tres medidas distintas, en versión de techo.

Technical data pag. 410

- Chrome-plated
- Copper





GRAAL

Gianni Arnaudo, 2008

Lampada da parete con corpo in tubo d'acciaio conificato a freddo, cromato lucido e dalla doppia emissione di luce: alogena indiretta nella parte superiore, a Led diretta nella parte inferiore con funzione di segnapasso.

Wall lamp with a conical, polished chromed body made from cold-shaped steel tube and dual light emission: indirect halogen above, direct Led below that acts as a guide.

Applique dont le corps est réalisé en tube d'acier conique usiné à froid, chromé brillant, avec double émission de lumière: halogène indirecte dans la partie supérieure, à Led directe dans la partie inférieure avec fonction de balisage.

Wandleuchte mit kalt verjüngtem kegelförmigem Stahlrohrkörper, glänzend verchromt und mit zweifacher Lichtausstrahlung: im oberen Bereich Halogen, indirekt, im unteren Bereich Led, direkt, als Orientierungsleuchte.

Lámpara de pared con cuerpo de tubo de acero conificado en frío, cromado brillante y de doble emisión luminosa: halógena indirecta en la parte superior y de led directa en la parte inferior, con función de indicador de paso.

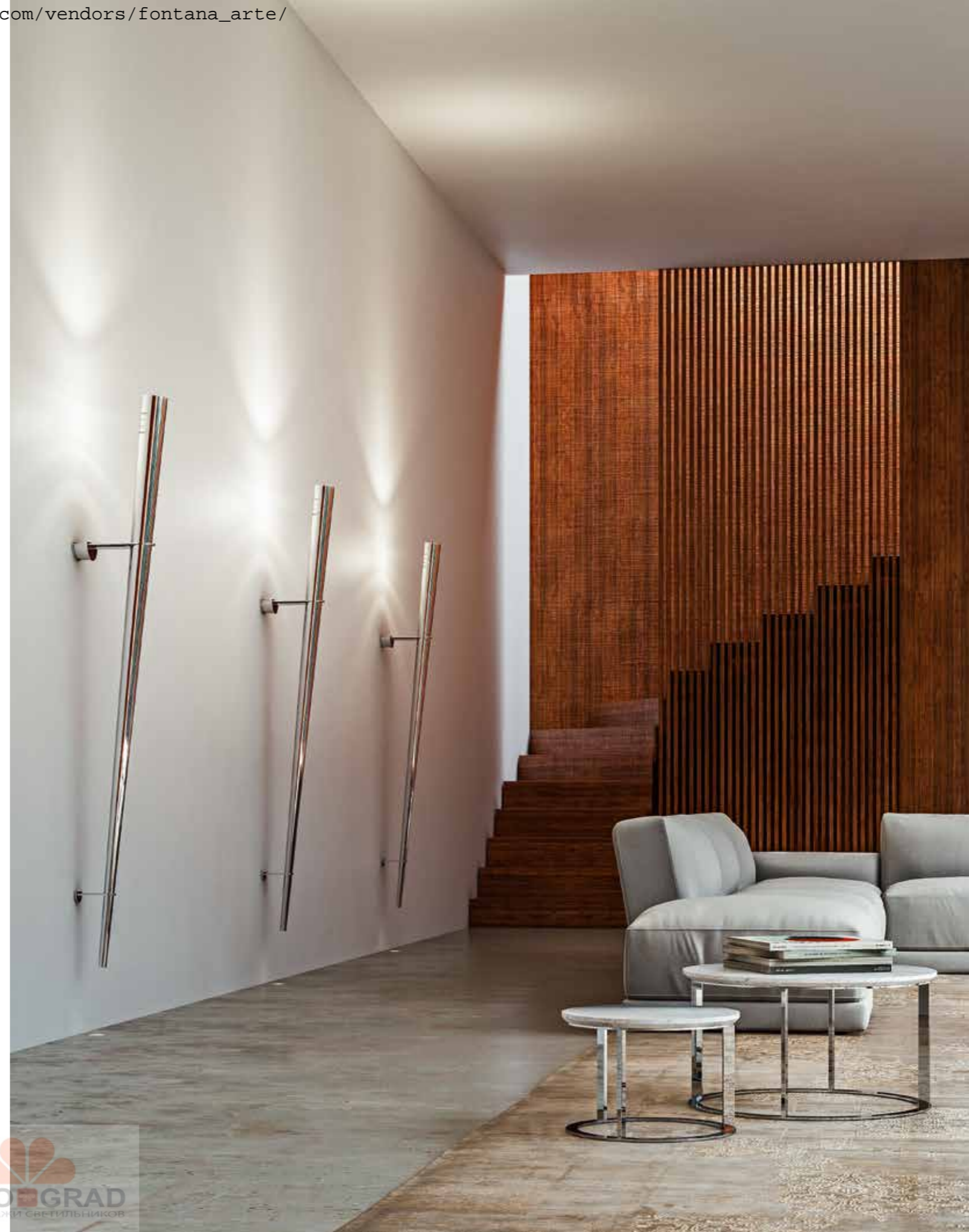

HUNA

FontanaArte Design Lab, 1965

Sospensione senza tempo in metallo verniciato con finitura bianca all'interno, per un'illuminazione diretta e intensa.

Still modern today, this suspension lamp in painted metal with white finish inside provides direct, intense illumination.

Suspension intemporelle en métal laqué avec finition blanche à l'intérieur, pour un éclairage direct et intense.

Stets aktuelle Pendelleuchte aus lackiertem Metall, mit weißem Finish an der Innenseite für eine direkte und intensive Beleuchtung.

Lámpara de techo siempre actual realizada en metal pintado con acabado blanco en el interior, para generar una iluminación directa e intensa.

Technical data pag. 411

- Aluminum
- Black



ICEBERG

Park Associati, 2003

Lampada da parete e plafone dal design minimale. Montatura in metallo verniciato alluminio. Diffusore in policarbonato opalino con testate in metacrilato trasparente.

Wand-und Deckenleuchte mit minimalistischem Design. Gestell aus aluminiumfarben lackiertem Metall. Diffusor aus opalweißem Polycarbonat mit Enden aus transparentem Methacrylat.

Minimal design wall and ceiling lamp. Frame in aluminum painted metal. Diffuser in opaline polycarbonate with ends in clear methacrylate.

Lámpara de pared y de plafón de diseño minimalista. Montura de metal pintado aluminio. Difusor de policarbonato opalino con extremos de metacrilato transparente.

Applique et plafonnier au design minimaliste. Structure en métal laqué aluminium. Diffuseur en polycarbonate opalin et extrémités en méthacrylate transparent.

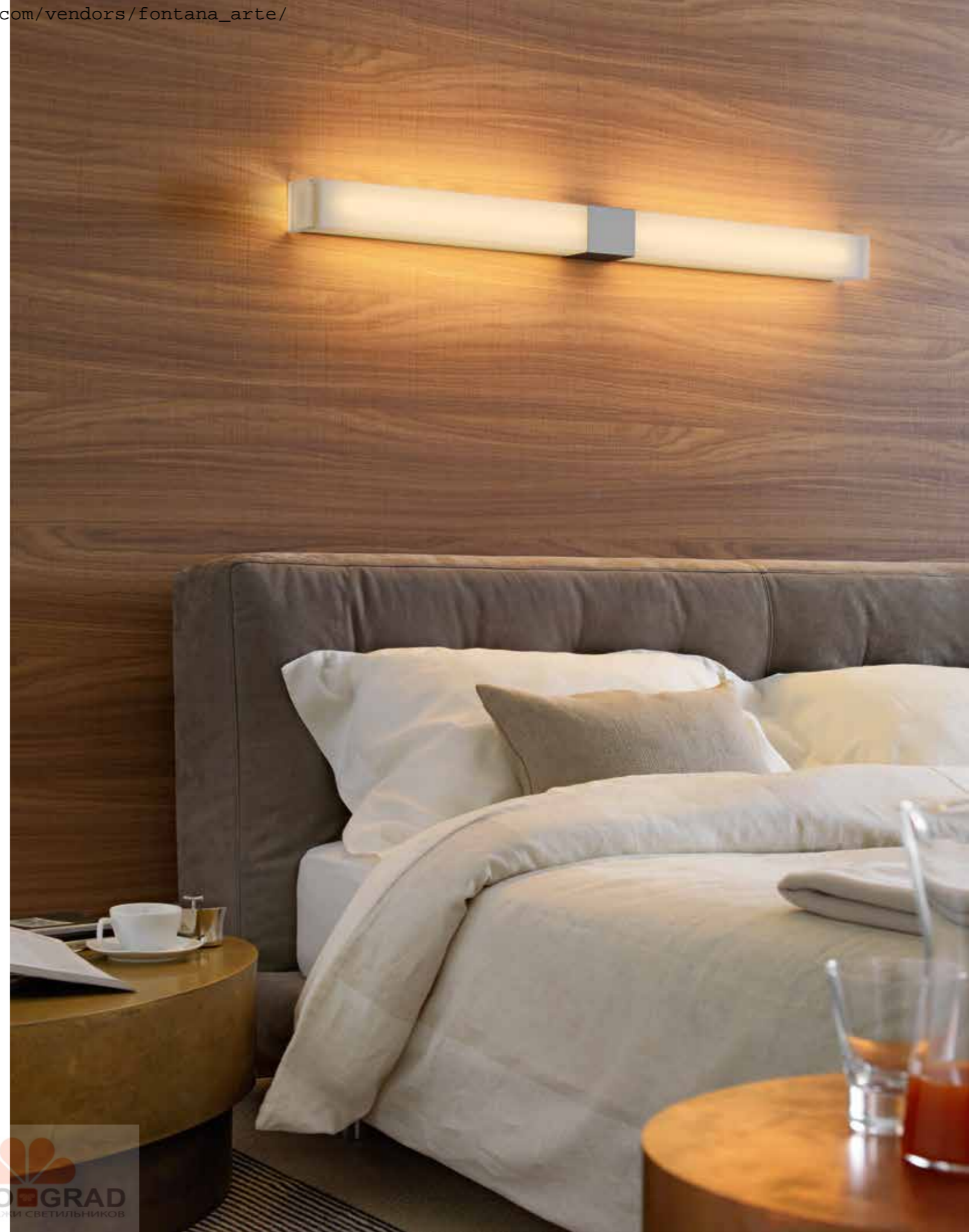



IGLOO

Studio Klass, 2014

Igloo è una famiglia di apparecchi a sospensione che comprende una serie di configurazioni down light oppure up e down light. L'elemento base è il singolo modulo in tecnopolimero plastico autoestinguente. Igloo è disponibile anche come sistema (Igloo System) con moduli, giunti e connessioni componibili fra loro nella massima libertà compositiva.

Igloo ist eine Pendelleuchtenfamilie, die eine Reihe von Down Light- oder Up- und Down Light-Konfigurationen einschließt. Grundelement ist das einzelne Modul aus selbstverlöschendem Technopolymer. Igloo ist auch als System (Igloo System) mit Modulen, Winkeln und Verbindungen erhältlich, die untereinander mit der größten Kompositionsfreiheit zusammengesetzt werden können.

Igloo is a family of suspension lamps in a series of down-light or up- and down-light configurations. The basic element is the unit in self-extinguishing plastic technopolymer. Igloo is also available as a system (Igloo System) with units, joints and connections for maximum freedom of composition.

Igloo es una familia de aparatos de techo que incluye una serie de configuraciones con la fuente luminosa dirigida hacia abajo o bien hacia arriba y hacia abajo. El elemento básico es el módulo individual de tecnopolímero plástico autoextinguible. También está disponible como sistema (Igloo System) con módulos, juntas y conexiones que pueden combinarse entre sí con la máxima libertad de composición.

Igloo est une famille de luminaires à suspension qui comprend une série de configurations «down light» ou «up light et down light». L'élément de base est le module simple en technopolymère plastique autoextinguible. Igloo est également disponible en version «système» (Igloo System) avec plusieurs modules, accouplements et connexions à assembler pour créer, en toute liberté, toute une série de compositions.

Technical data pag. 413

- Dark grey
- White grey

Reddot Design Award 2015
ADI Design Index 2015



IO

Claesson Koivisto Rune , 2015

IO è un apparecchio di illuminazione a parete progettato per sorgenti luminose LED. La sua peculiarità sta nel fatto che, grazie ad una montatura dal doppio asse di rotazione, la lampada ruota sia sull'asse longitudinale sia lungo quello trasversale e consente perciò una gestione totale della luce. IO è facilmente impugnabile e maneggiabile grazie alle sue dimensioni. Con un movimento Up/Down sul diffusore esterno è possibile inoltre aprire e chiudere il fascio luminoso.

Mit der Form einer kleinen gebogenen Mondscheibe ist IO ein Wandbeleuchtungskörper für LED-Lichtquellen. Seine Besonderheit besteht darin, dass die Leuchte sich dank eines Gestells mit Doppeldrehachse sowohl auf der Längsachse als auch längs der Querachse dreht und so ein komplettes Lichtmanagement möglich macht. IO kann durch seine Größe leicht gehandhabt werden und mit einer Auf- und Ab-Bewegung am äußeren Diffusor kann der Lichtstrahl außerdem geöffnet und geschlossen werden.

In the shape of a small curved lunar disc, IO is a wall lamp designed for LED light sources. Thanks to its dual-axis rotation frame, it has the distinguishing feature rotating on both longitudinal and transversal axes, for a total light management. IO is easy to handle and adjust thanks to its size. The Up/Down movement on the external diffuser widens and narrows the ray of light.

Con la forma de un pequeño disco lunar curvado, IO es un aparato de iluminación de pared diseñado para fuentes luminosas LED. Su peculiaridad consiste en que, gracias a una montura con doble eje de rotación, la lámpara gira tanto sobre el eje longitudinal como sobre el transversal, por lo que permite gestionar totalmente la luz. Gracias a sus dimensiones, IO es fácil de empuñar y manejar. Además, con un movimiento Up/Down del difusor externo se puede abrir y cerrar el haz luminoso.

De la forme d'un petit disque lunaire courbe, IO est un luminaire mural conçu pour des sources lumineuses à LED. Sa particularité réside dans le fait que grâce à une monture avec double axe de rotation, la lampe tourne aussi bien sur l'axe longitudinal que sur l'axe transversal et permet par conséquent une gestion totale de la lumière. IO est facile à saisir et à orienter grâce à ses dimensions, avec un mouvement vers le haut ou vers le bas sur le diffuseur extérieur, il est possible par ailleurs d'ouvrir et de fermer le faisceau lumineux.

- Graphite grey
- Red
- White
- Blue

Technical data pag. 418





Wall

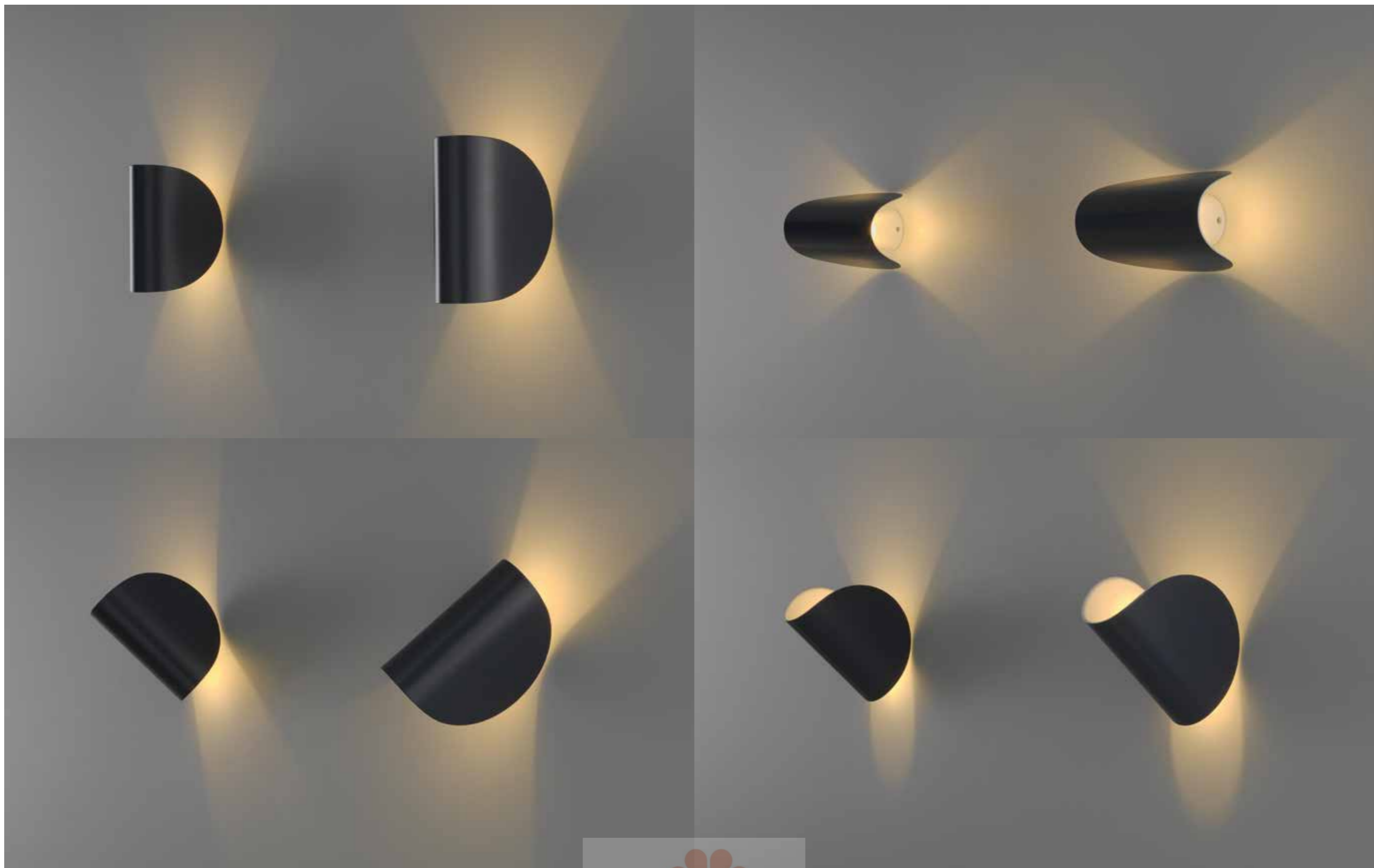

KIASMA

Steven Holl, 2000

Due lastre in metallo curvato compongono questa lampada da parete il cui disegno si ispira al modello realizzato per il Kiasma Museum di Helsinki dallo stesso Steven Holl.

Zwei gebogene Metallplatten bilden diese Wandleuchte, deren Design sich an dem Modell für das Kiasma Museum in Helsinki von Steven Holl inspiriert.

Two curved metal plates form this wall lamp whose design is inspired by the model created for the Kiasma Museum in Helsinki by Steven Holl himself.

Dos placas de metal curvado componen esta lámpara de pared, cuyo diseño se inspira en el modelo realizado para el Kiasma Museum de Helsinki por el mismo Steven Holl.

Deux plaques de métal cintré composent cette applique dont le dessin s'inspire du modèle déjà réalisé pour le Kiasma Museum d'Helsinki par Steven Holl.



KINX

Karim Rashid, 2015

Kinx è una lampada da tavolo che coniuga in modo quasi simbiotico design e funzionalità. La testa è composta da un'asola di lumen a LED regolabili. Maneggiabile e adattabile nella posizione gradita, è un oggetto pensato per portare allegria e leggerezza. Il fascio luminoso è gestito elettronicamente - On/Off Dim con attuatore ottico e punto di segnalazione di colore blu.

Kinx ist eine Tischleuchte, bei der sich Design und Funktionalität fast symbiotisch verbinden. Der Kopf besteht aus einer Lumenschleife mit regulierbaren LEDs. Diese Leuchte ist einfach zu handhaben, passt sich gut der gewünschten Position an und wurde entwickelt, um fröhlich und leicht zu stimmen. Der Lichtstrahl wird elektronisch verwaltet - On/Off Dim mit optischem Aktor und blauem Anzeigepunkt.

Kinx is a table lamp that is the almost symbiotic union of design and practicality. The head is a loop of lumens with dimmable LEDs. Easy to handle and adjust into the position desired, it is an article thought up to bring cheer and lightness. The light beam is electronically managed - On/Off Dim with blue optical actuator and signal point.

Kinx es una lámpara de sobremesa que combina de modo casi simbiótico diseño y funcionalidad. La cabeza está compuesta por un ojal de luz LED de lúmenes regulables. Manejable y adaptable a la posición deseada, es un objeto concebido para aportar alegría y ligereza. El haz luminoso es gestionado electrónicamente - On/Off Dim con actuador óptico y punto de señalización de color azul.

Kinx est une lampe de table où design et fonctionnalité coexistent en une forme de symbiose. La tête est formée d'une boucle lumineuse à LED réglables. Cet objet maniable, à positionner à notre convenance, est conçu pour évoquer la gaieté et la légèreté. Le faisceau lumineux est géré électroniquement - On/Off Dim avec un actionneur optique et un point lumineux de couleur bleue.

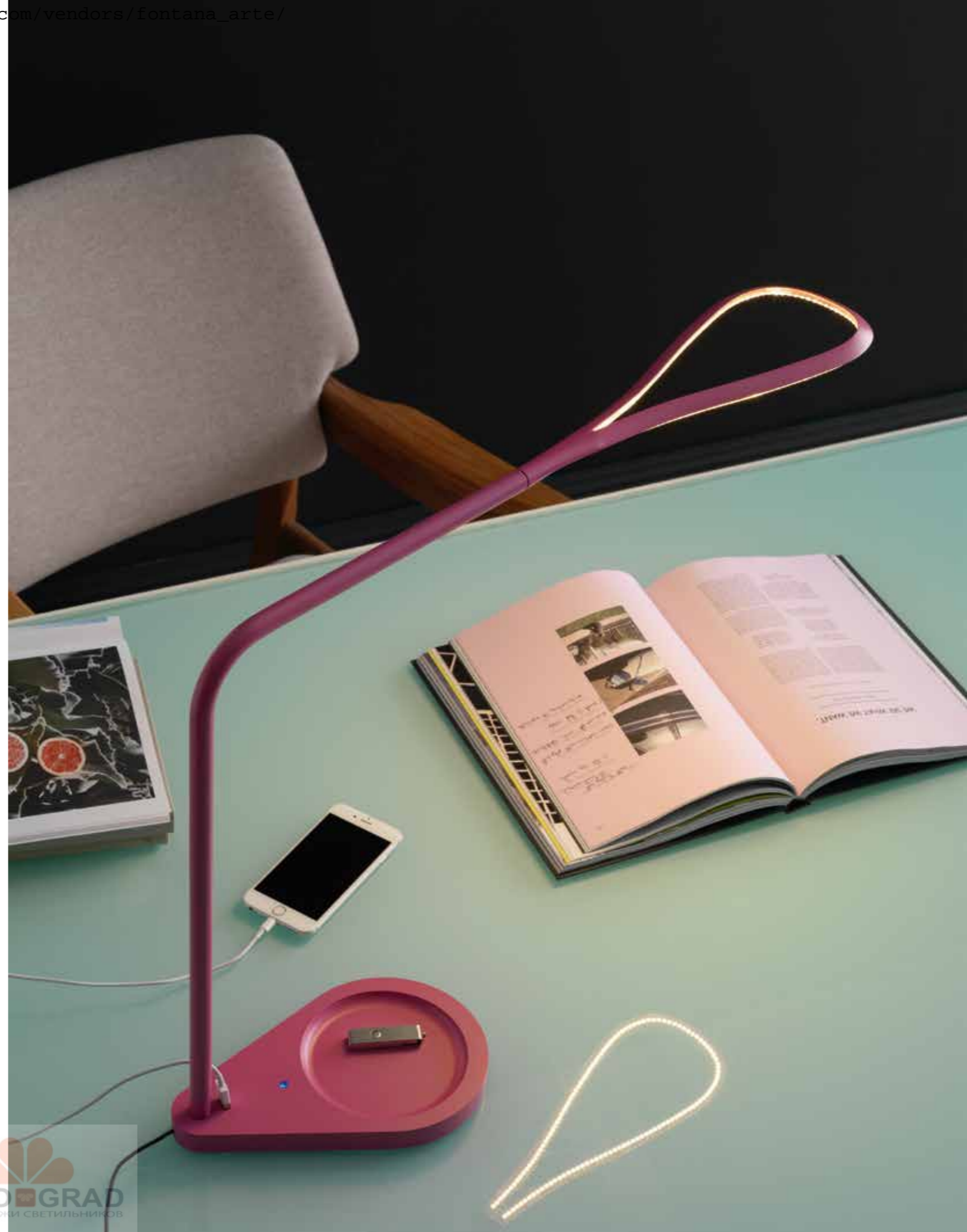

LAMPARA

FontanaArte Design Lab, 1965

Rievoca le architetture industriali questa lampada a sospensione con paralume in alluminio naturale oppure cromato e riflettore verniciato bianco all'interno.

Reminiscent of industrial architecture, this hanging lamp has a natural or chromed aluminum shade and the reflector is painted white inside.

Cette suspension, avec abat-jour en aluminium naturel ou chromé et réflecteur laqué blanc à l'intérieur, évoque les architectures industrielles.

Diese Leuchte mit dem Schirm aus Natur-Aluminium oder verchromt und weiß lackiertem Reflektor auf der Innenseite erinnert an die Industriearchitekturen.

Lámpara de techo con pantalla de aluminio natural o cromado y reflector pintado blanco en el interior que evoca las arquitecturas industriales.

Technical data pag. 420

- Aluminum
- Chrome-plated





LOOP

Voon Wong + Benson Saw, 2003

Oggetto luminoso in acciaio inox dal fascino unico. Grazie alla rotazione della parte superiore della struttura è possibile la totale regolazione dell'intensità luminosa. Loop si può appoggiare a piacimento su un tavolo oppure a terra.

Lichtobjekt aus Edelstahl mit einmaligem Charme. Durch drehen des oberen Teils der Struktur ist die gesamte Regulierung der Lichtintensität möglich. Loop kann auf dem Tisch oder am Boden aufgestellt werden.

A luminous object in stainless steel with unique appeal. The upper part of the body rotates to allow complete management of the intensity of the light. Loop can be put on a table or on the floor.

Objeto luminoso de acero inoxidable de encanto único. La rotación de la parte superior de la estructura permite regular totalmente la intensidad luminosa. Loop puede apoyarse sobre una mesa o en el suelo.

Objet lumineux en acier inox au charme unique. La rotation de la partie supérieure de la structure permet de régler totalement l'intensité lumineuse. Loop peut se poser sur une table ou au sol.



LOUNGE

Luisa Calvi, Mauro Merlini and Carlos Moya, 2003

Lampada da parete realizzata in metacrilato serigrafato e proposta nella versione trasparente o arancione. Gli schermi di chiusura, superiore ed inferiore, sono in vetro sabbato.

Wall lamp in screen-printed methacrylate in either a clear or orange version. The screens top and bottom are in sandblasted glass.

Applique réalisée en méthacrylate sérigraphié, proposée en version transparente ou orange. Les écrans de fermeture, supérieur et inférieur, sont en verre sablé.

Wandleuchte aus serigraphiertem Methacrylat, die in transparenter oder orangefarbener Ausführung angeboten wird. Die Verschlusschirme oben und unten sind aus sandgestrahltem Glas.

Lámpara de pared realizada en metacrilato serigrafiado y propuesta en versión transparente o naranja. Las pantallas de cierre, superior e inferior, son de vidrio arenado.

Technical data pag. 421

- Orange
- Transparent

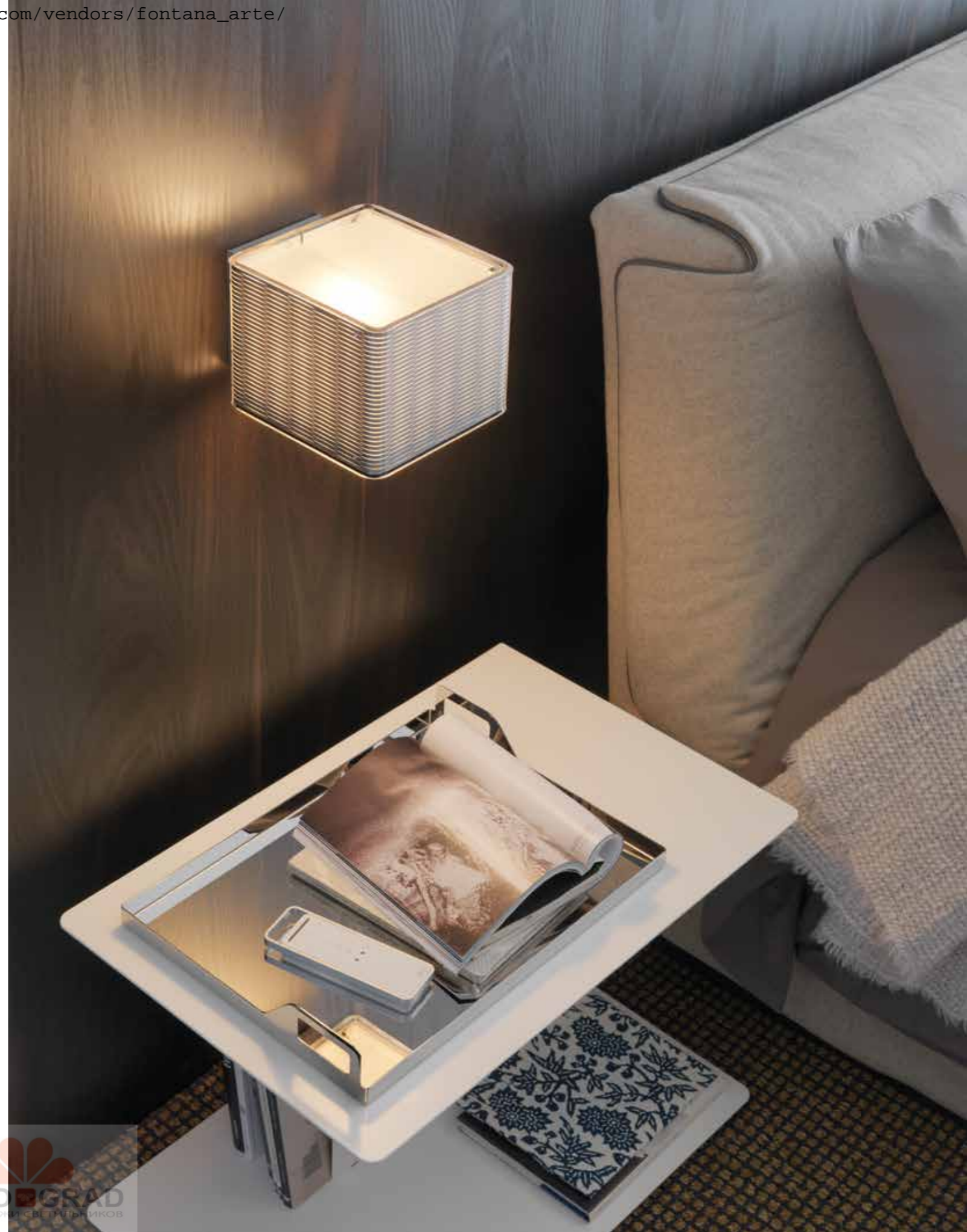

LUMEN

Historical Archive, 1954

La più classica delle lampade da terra, provvista di un diffusore in vetro soffiato bianco opalino satinato e di una base che diventa, senza soluzione di continuità, uno stelo.

Die klassischste der Bodenleuchten mit einem Diffusor aus opalweißem mundeblasenem und satiniertem Glas und einer Basis, die ohne Unterbrechung in einem Stab übergeht.

The most classic of floor lamps, fitted with a diffuser in frosted white opaline blown glass and a base and stem in a single piece.

La más clásica de las lámparas de pie, provista de un difusor de vidrio soplado blanco opalino satinado y de una base que se convierte en pie sin solución de continuidad.

Le lampadaire classique par excellence, avec un diffuseur en verre soufflé blanc opalin satiné et une base qui se prolonge, sans interruption, pour former la tige.



LUMINATOR

Pietro Chiesa, 1933

Lampada dalla personalità così attuale che la sua data di nascita sembra incredibile. Uno stelo lungo dal diametro stretto, si allarga con continuità verso l'alto, descrivendo un cono rovesciato che cela la fonte luminosa. Luminator è il primo esempio di lampada da terra ad emissione indiretta apparso sul mercato.

Eine Lampe mit so aktueller Persönlichkeit, dass ihr Geburtsdatum unglaublich scheint. Ein langer Stab mit engem Durchmesser, welcher sich kontinuierlich nach oben erweitert und einen umgekippten Kegel beschreibt, in dem sich die Lichtquelle verbirgt. Luminator ist das erste Beispiel für eine Bodenleuchte mit indirekter Lichtemission, das auf dem Markt erschien.

A lamp with such a modern personality that its date of birth is hard to believe. A long, narrow stem opens in an upward swoop to catch an upturned cone that hides the light source. Luminator was the first example on the market of an indirect emission floor lamp.

Lámpara con una personalidad tan actual que su fecha de nacimiento parece increíble. Un pie de lámpara largo, de diámetro estrecho, va ensanchándose continuamente hacia arriba describiendo un cono invertido que cela la fuente luminosa. Luminator es el primer ejemplo de lámpara de pie de emisión indirecta lanzado al mercado.

Lampe à la personnalité si actuelle que sa date de naissance semble incroyable. Une tige longue de faible diamètre s'évase vers le haut de manière continue, formant ainsi un cône renversé qui renferme la source lumineuse. Luminator est le premier exemple de lampadaire à lumière indirecte apparu sur le marché.



LUNAIRE

Ferréol Babin, 2013

Lampada da parete e plafone che stupisce per il suo effetto luminoso che ricorda il fenomeno di luce prodotto dalle eclissi. Un grande riflettore in alluminio dalla forma concava ospita al suo interno un disco frontale più piccolo; quest'ultimo, che alloggia al suo interno la fonte luminosa, produce una luce diversa in base a come si posiziona rispetto al diffusore.

A wall and ceiling lamp with a surprising light effect, reminiscent of the phenomenon produced by eclipses. The light produced depends on the position of the smaller front disc containing the light source with regard to the large concave aluminum diffuser that holds it.

Applique et plafonnier, elle surprend par son effet lumineux qui évoque le phénomène produit par les éclipses. Un grand réflecteur en aluminium à la forme concave loge en son centre un disque frontal plus petit. Ce dernier, qui contient la source lumineuse, produit une lumière différente selon la façon dont il est positionné par rapport au diffuseur.

Lunaire ist eine Wand- und Deckenleuchte, die durch ihren Leuchteffekt beeindruckt und an das Phänomen des bei einer Sonnenfinsternis erzeugten Lichts erinnert. Ein großer Aluminiumdiffusor mit konkaver Form hat in seiner Mitte eine kleinere Frontscheibe. Letztere, in deren Innerem sich die Leuchtquelle befindet, erzeugt ein Licht, das je nachdem, wie man sie im Verhältnis zum Diffusor positioniert, verschieden ist.

Lámpara de pared y plafón que impacta por su efecto luminoso y que recuerda el fenómeno de luz que se produce durante los eclipses. Un gran reflector de aluminio de forma cóncava aloja en su interior un disco frontal más pequeño; este último, que contiene la fuente luminosa, produce una luz distinta dependiendo de su posición con respecto al difusor.

- Aluminum/black
- Copper/black
- Copper/copper
- Copper/gold
- Gold/black
- Gold/copper
- Gold/gold
- White/black
- White/white

Technical data pag. 423

Reddot Design Award 2014 / Honourable Mention
ADI Design Index 2014



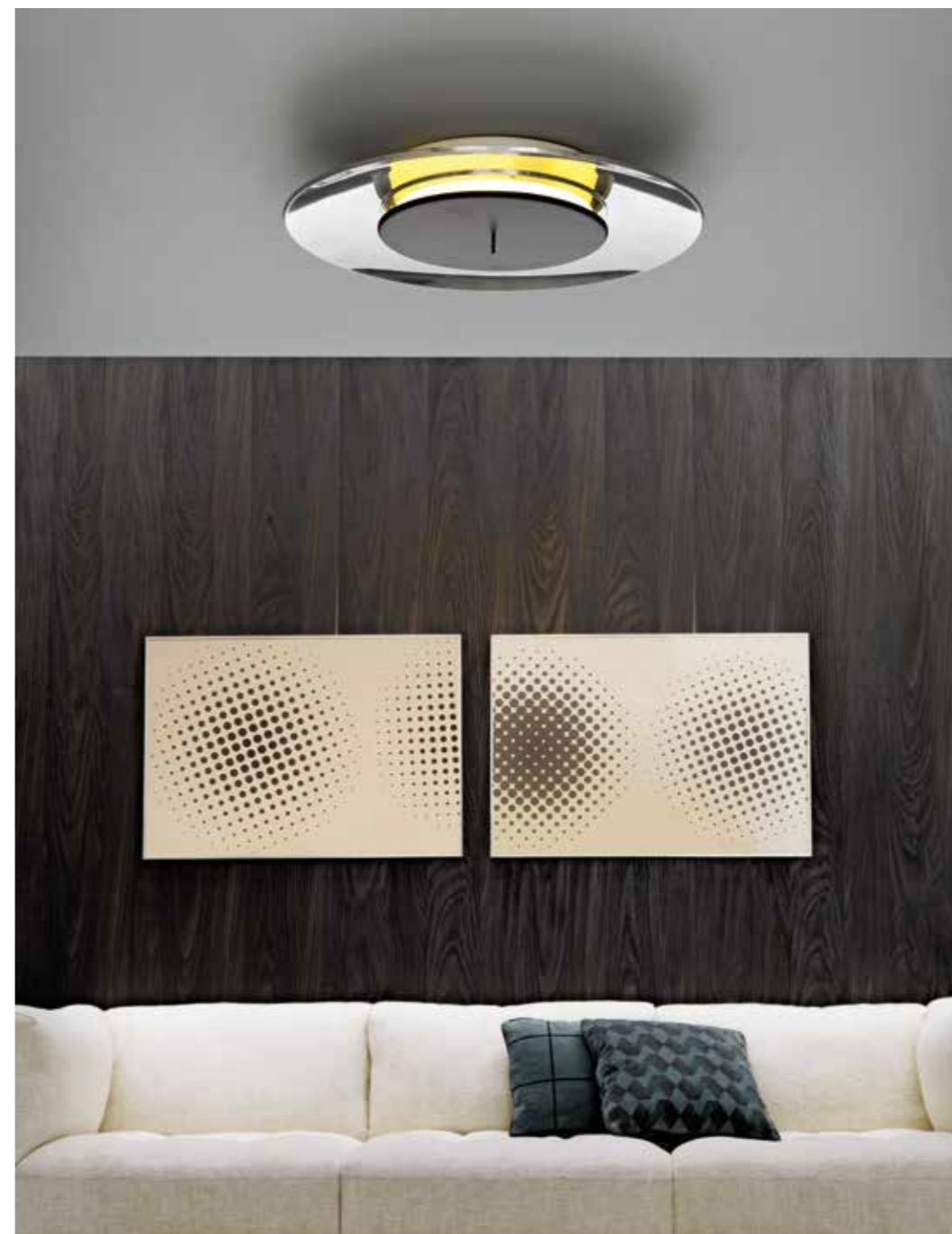

MANO

Pietro Chiesa, 1932

Questa lampada, anticipatrice per ironia ed eleganza, ha la base e la mano in polvere di marmo e resina e lo stelo in metallo a sezione quadrata. Il diffusore è in tessuto nero.

Die Leuchte, ein Vorläufer für Ironie und Eleganz, hat die Basis und Hand aus Marmorstaub und Harz und den Stab aus Metall mit quadratischem Querschnitt. Basis und Stab sind in schwarz matt ausgeführt.

This lamp, a trendsetter thanks to its irony and elegance, comprises a base and hand in marble powder and resin and a square section stem in metal. The diffuser is in black fabric.

Lámpara pionera por su ironía y elegancia: la base y la mano son de polvo de mármol y resina y el pie de metal, con sección cuadrada. El difusor es de tejido negro.

Cette lampe avant-gardiste, aussi ironique qu'élégante, comprend une base et une main en poudre de marbre et résine et une tige en métal à section carrée. Le diffuseur est en tissu noir.





MARGARET

Vico Magistretti, 2000

Lampada da appoggio per una piacevole lettura sul divano oppure a letto. Riflettore in alluminio brillantato e lucidato. Tige telescopica in ottone cromato. Sacca d'appoggio in pelle marrone oppure nera.

Reading lamp that rests on the back of a sofa or bedhead. Reflector in polished, buffed aluminum. Telescopic rod in chromed brass. Supporting bag in brown or black leather.

Lampe à poser sur le dossier d'un canapé ou sur une tête de lit pour une lecture confortable. Réflecteur en aluminium brillant et poli. Tige télescopique en laiton chromé. Coussin d'appui en cuir marron ou noir.

Leuchte für angenehme Lektüre, die auf der Rückenlehne des Sofas oder am Bettkopf aufgelegt werden kann. Reflektor aus hochglanzpoliertem Aluminium. Teleskopstab aus verchromtem Messing. Auflageelement aus braunem oder schwarzem Leder.

Lámpara para disfrutar de una agradable lectura. Se apoya sobre el respaldo del sofá o en el cabezal de la cama. Reflector de aluminio pulido y bruñido. Barra telescópica de latón cromado. Bolsa de apoyo de piel marrón o negra.



MARISTELLA

Historical Archive, 1995

Lampada da parete dal design minimale. Montatura in metallo cromato e diffusore in vetro stampato. Disponibile in due lunghezze.

Minimal design wall lamp. Frame in chromed metal and diffuser in printed glass. Available in two different lengths.

Applique au design minimaliste. Structure en métal chromé et diffuseur en verre moulé. Disponible en deux longueurs.

Wandleuchte mit minimalistischem Design. Gestell aus verchromtem Metall und Diffusor aus Pressglas. In zwei Längen erhältlich.

Lámpara de pared de diseño minimalista. Montura de metal cromado y difusor de vidrio grabado. Disponible en dos longitudes.

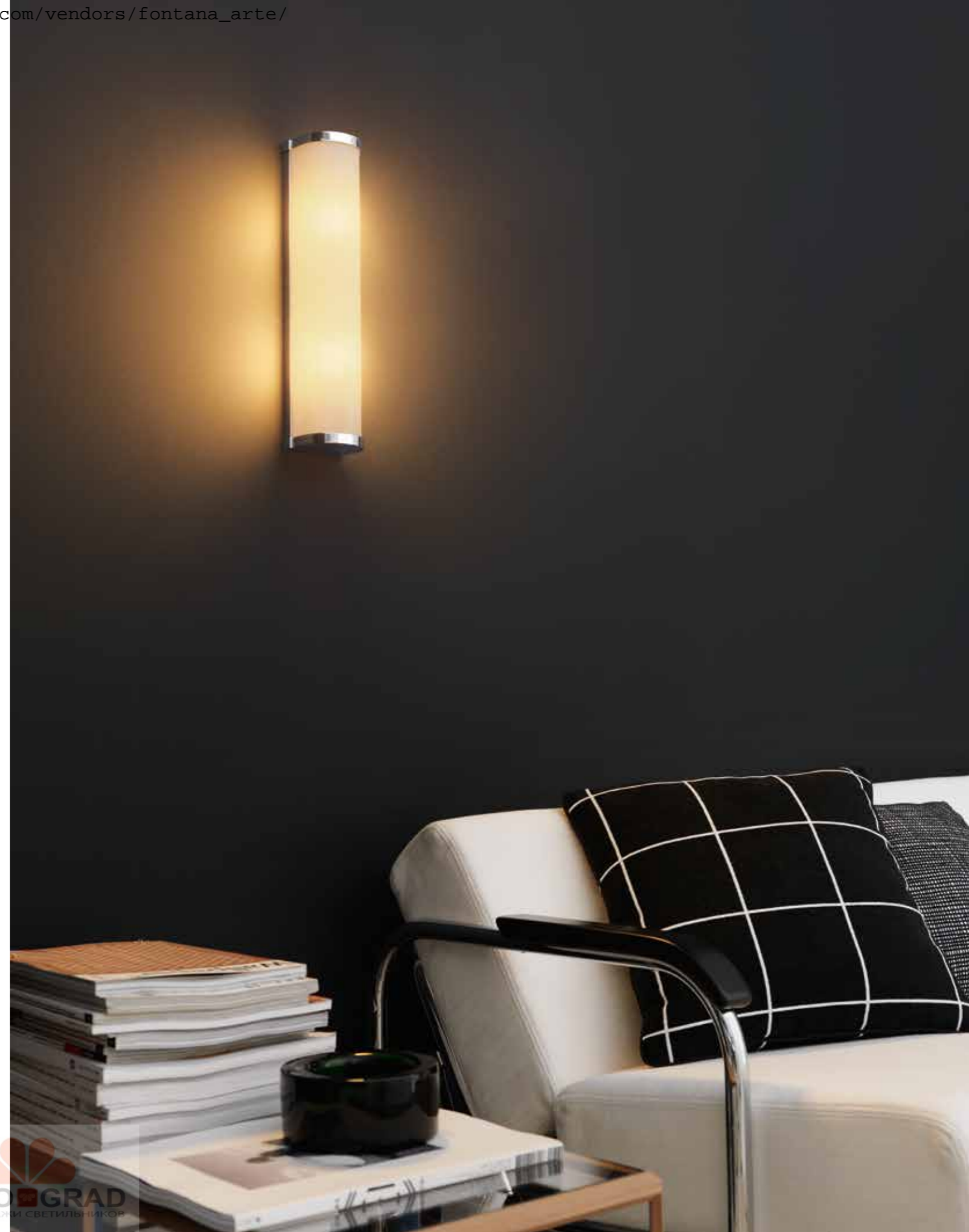

MILANO 2015

Carlo Colombo, 2015

FontanaArte rende omaggio a Milano, la città in cui è nata, con una lampada da tavolo inedita e esclusiva: Milano 2015. Firmata da Carlo Colombo, è realizzata in marmo statuario di Carrara, il marmo più pregiato e prezioso, da sempre quello preferito da scultori e artisti per le loro realizzazioni. La lampada è provvista di una scheda Led che irradia una luce magica, che esalta le venature del marmo.

FontanaArte pays homage to Milan, the city of its origins, with a brand new, exclusive table lamp: Milano 2015. Designed by Carlo Colombo, it is made from Carrara statue marble; the finest and most valuable marble and all-time favorite with sculptors and artists for their creations. This lamp has a Led board that glows with magical light, enhancing the veins in the marble.

FontanaArte rend hommage à Milan, la ville où l'entreprise est née. Une lampe de table inédite et exclusive: Milano 2015, Signée Carlo Colombo, réalisée en marbre statuaire de Carrare, le plus beau et le plus précieux, celui que les sculpteurs et les artistes préfèrent utiliser, depuis toujours, pour leurs créations. La lampe est dotée d'une carte Led diffusant une lumière magique illuminant les veines du marbre.

FontanaArte möchte mit der neuen exklusiven Tischleuchte Milano 2015 der Stadt Mailand, Geburtsort des Unternehmens Hochachtung zollen. Aus der Designerhand von Carlo Colombo stammt die Leuchte aus Statuario-Marmor aus Carrara, dem erlesensten und wertvollsten Marmor, der sich seit jeher schon unter den Bildhauern und Künstlern großer Beliebtheit erfreut. Die Leuchte ist mit einer Led-Platine versehen, die ein magisches Licht erzeugt, das die Maserungen des Marmors schön betont.

FontanaArte rinde homenaje a Milán, la ciudad donde nació con una lámpara de mesa inédita y exclusiva: Milano 2015. Firmada por Carlo Colombo, está realizada en mármol estatuario de Carrara, el mármol más preciado y elegante, y el preferido desde siempre por escultores y artistas para realizar sus obras. La lámpara dispone de una tarjeta Led que irradia una luz mágica resaltando las vetas del mármol.



NASKA 1, NASKA 2, NASKETTA

Historical Archive, 1933

La famiglia di lampade Naska è un classico dal 1933. Semplice e funzionale, con un braccio orientabile in tutte le direzioni, è disponibile in tre diversi versioni da tavolo e anche da terra e parete.

The Naska family of lamps is a classic from 1933. Simple and functional, with a revolving, adjustable arm, it is available in three different versions – table, floor and wall.

La famiglia di lampade Naska è un classico dal 1933. Semplice e funzionale, con un braccio orientabile in tutte le direzioni, è disponibile in tre diversi versioni da tavolo e anche da terra e parete.

Die Leuchtenfamilie Naska ist ein Klassiker aus dem Jahre 1933. Einfach, robust und funktionell, mit einem allseitig verstellbarem Doppelarm und dem im Leuchtenkopf integrierten Ein/Aus Drehschalter, ist sie in drei verschiedenen Versionen für Tisch, Boden und Wand erhältlich.

La familia de lámparas Naska es un clásico desde 1933. Simple y funcional, con un brazo orientable en todas las direcciones, está disponible en tres versiones distintas de sobremesa y en versión de pie y de pared.

- Black
- Chrome-plated
- White

Technical data pag. 425

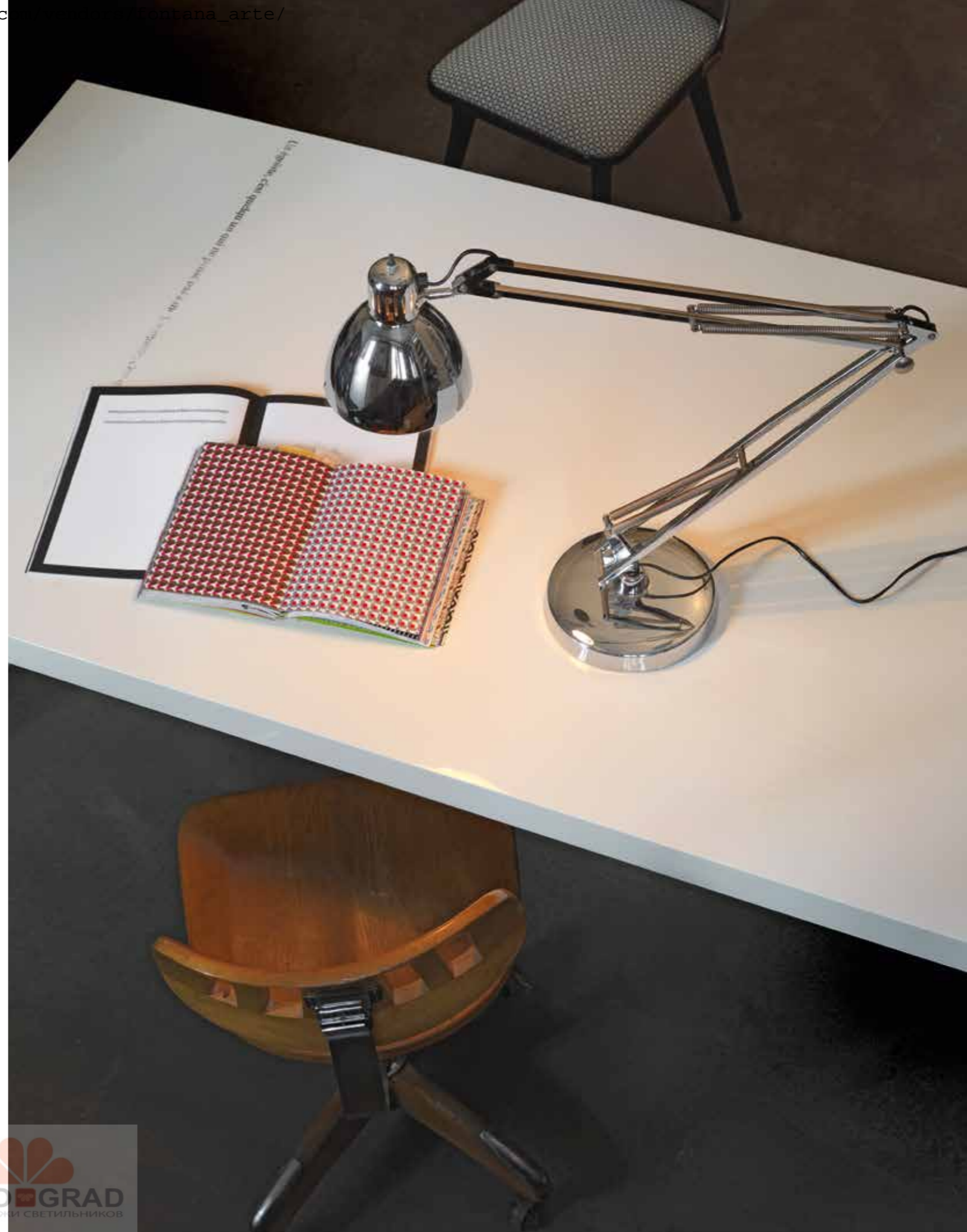



NASKA 1, NASKA 2, NASKETTA

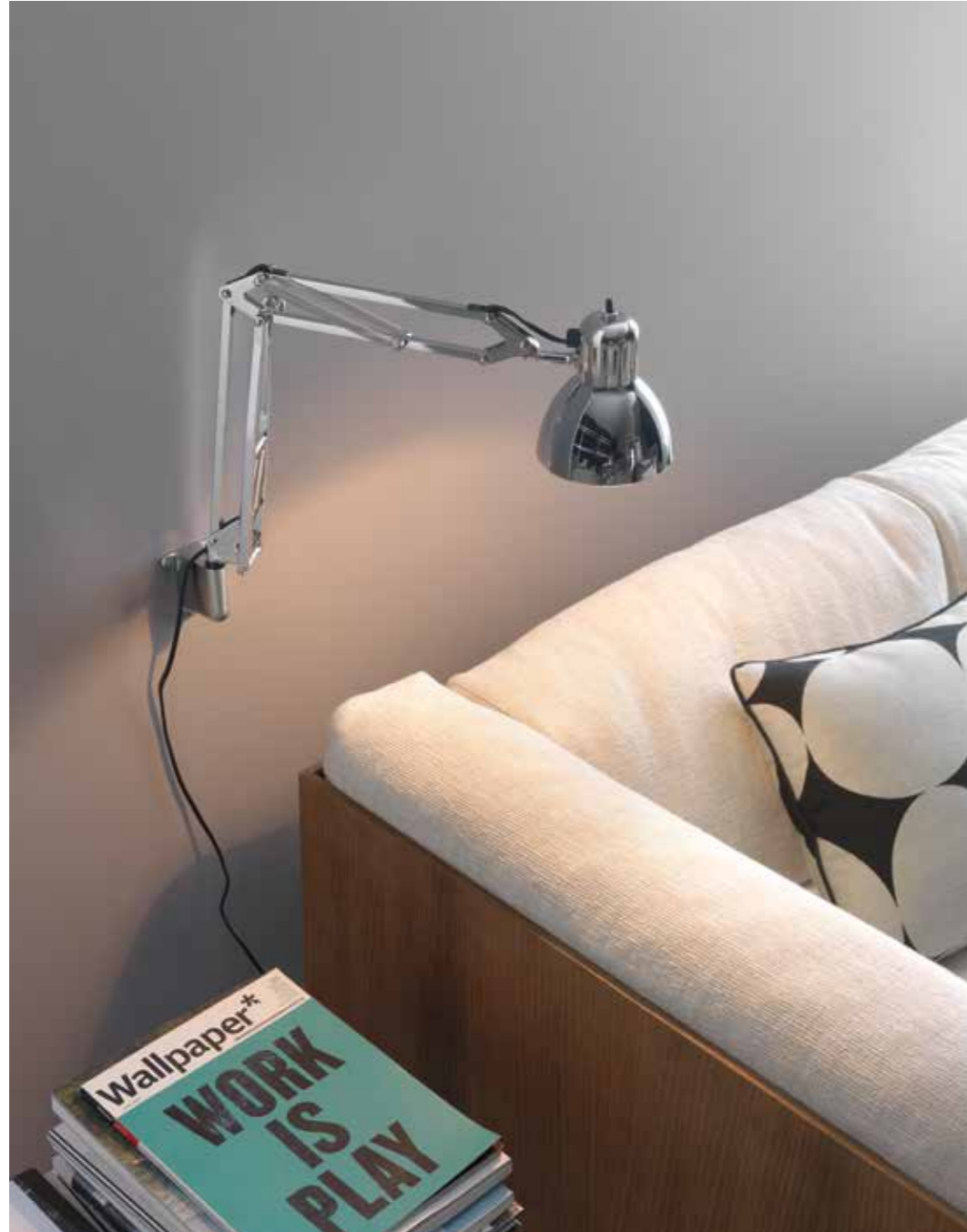

NASKA 1, NASKA 2, NASKETTA

NOBI

Metis Lighting, 1992

Declinata nelle versioni da terra, a parete e a sospensione, Nobi garantisce massima funzionalità dal design innovativo ed elegante. I due vetri concavi accostati sono mantenuti in posizione da un sistema di piccole molle e fissati alla struttura metallica con due perni. Il diffusore può così ruotare su se stesso e orientare il flusso luminoso nella direzione desiderata.

Als Boden-, Wand- und Pendelleuchte garantiert Nobi höchste Funktionalität mit innovativem und elegantem Design. Die beiden konkaven Gläser werden durch ein System kleiner Federn in ihrer Position gehalten und sind an der Metallstruktur durch zwei Bolzen befestigt. Auf diese Weise kann der Diffusor sich um sich selbst drehen und den Lichtstrom in die gewünschte Richtung orientieren.

In floor, wall and suspension versions, Nobi guarantees total practicality for innovative elegant design. The two bowl-shaped glass discs are held in position by a system of tiny springs and fastened to the metal frame by two pins. In this way the diffuser rotates on itself, directing its halogen beam as required.

Declinada en las versiones de pie, de pared y de techo, Nobi garantiza la máxima funcionalidad con un diseño innovador y elegante. Los dos vidrios cóncavos adosados se mantienen en su posición mediante un sistema de pequeños muelles y están acoplados a la estructura metálica con dos pernos. De este modo el difusor puede girar sobre sí mismo y orientar el flujo luminoso en la dirección deseada.

Proposée dans les versions lampadaire, applique et suspension, Nobi garantit une fonctionnalité maximale et un design innovant et élégant. Les deux verres concaves assemblés sont maintenus en place par un système de petits ressorts et fixés à la structure métallique par deux axes. Le diffuseur peut ainsi pivoter sur lui-même et orienter le flux lumineux dans la direction désirée.

- Chrome-plated
- Nickel-plated
- White

Technical data pag. 427





NOBI 2

Metis Lighting, 1992

- Chrome-plated
- Nickel-plated

Technical data pag. 430





NOBI 4

Metis Lighting, 1992

Technical data pag. 430

- Chrome-plated
- Nickel-plated



NUOVA SEGNO TRE

Pierluigi Cerri (Gregotti Associati), 1988

Lampada da terra dal design classico con struttura in metallo verniciato grigio chiaro o cromato e conetto diffusore in vetro bianco.

Classic design floor lamp with structure in pale grey painted or chromed metal and diffuser cone in white glass.

Lampadaire au design classique dont la structure en métal laqué gris clair ou chromé est surmontée d'un cône diffuseur en verre blanc.

Bodenleuchte mit klassischem Design und mit hellgrau lackierter oder verchromter Metallstruktur und Diffusorkegel aus weißem Glas.

Lámpara de pie de diseño clásico con estructura de metal pintado o gris claro o cromado y cono difusor de vidrio blanco.

Technical data pag. 431

- Grey
- Chrome-plated



ODEON

Studio Klass, 2013

Rivestita in cuoio, un materiale caldo, naturale e piacevole al tatto, Odeon è dotata di una maniglia di presa grazie alla quale può essere trasportata per casa e orientata verso una parete, per un effetto luminoso wall washer più o meno ampio in funzione della distanza dal muro. Disponibile in 4 varianti di colore.

Mit Leder, einem warmen, natürlichen und bei Berührung angenehmen Material, bezogen, ist Odeon mit einem Handgriff versehen, mit dem sie in der Wohnung transportiert werden kann, auf eine Wand gerichtet werden kann, für einen je nach Abstand von der Wand mehr oder weniger großen Wall Washer-Effekt. Erhältlich in 4 verschiedenen Farbvarianten.

Covered in leather, a warm, natural, touch-friendly material, Odeon has a finger loop for moving it around the home. Pointed towards a wall it creates a wall-washer effect, the width of which will depend on its distance from the wall. Available in 4 different colors.

Revestida en cuero, un material cálido, natural y agradable al tacto, Odeon está dotada de un asa que permite desplazarla por la casa, orientada hacia una pared, para obtener un efecto luminoso de baño de pared más o menos amplio en función de su distancia a esta última. Disponible en 4 variantes de color.

Revêtue de cuir, une matière chaude, naturelle et agréable au toucher, Odeon est munie d'une poignée grâce à laquelle elle peut être transportée dans toute la maison et orientée vers un mur, pour un effet lumineux « lèche-mur » plus ou moins étendu selon la distance entre la lampe et le mur. Disponible en 4 coloris.

- Cognac
- Dark brown
- Orange
- White

Technical data pag. 431

iF Product Design Award 2014

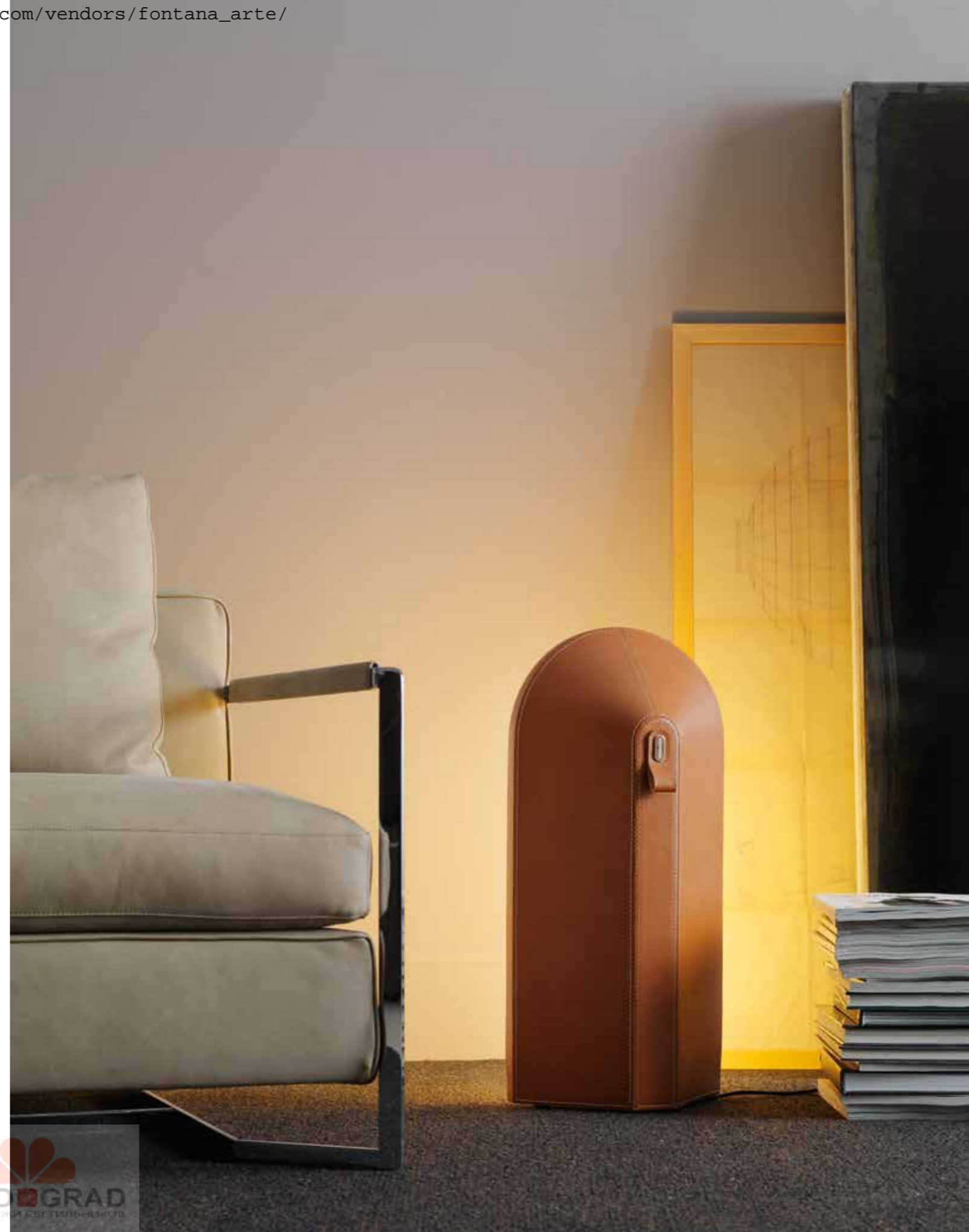

PANGEN

Historical Archive, 2012

Il paralume è una cupola dalla forma fluida e minimale la cui finitura laccata, proposta in diversi colori, regala riflessi di luce sorprendenti. Disponibile in versione sospensione e plafone.

This lampshade is a fluid, minimal dome shape, its lacquer finish and modern colors ensuring surprising lighting. Available in suspension and ceiling mounted versions.

L'abat-jour est une coupole à la forme fluide et minimale dont la finition laquée, dans les coloris les plus actuels, offre de surprenants reflets de lumière. Disponible en version suspension ou plafonnier.

Den Leuchtschirm bildet eine Kuppel mit flüssiger und minimalistischer Form, deren lackierte Oberfläche in hochaktuellen Farben überraschende Lichtreflexe schenkt. Erhältlich als Pendel- und Deckenleuchte.

La pantalla es una cúpula de forma fluida y minimalista cuyo acabado lacado, en colores actualísimos, regala sorprendentes reflejos de luz. Disponible en versión de techo y plafón.

- Black
- Green
- Orange
- Red
- White

Technical data pag. 432





PANGEN



PAROLA, PAROLONA

Gae Aulenti / Piero Castiglioni, 1980

Nella lampada Parola convivono in un solo oggetto tre diverse tipologie e lavorazioni del vetro: soffiato opalino nel paralume orientabile, naturale nello stelo, cristallo naturale molato nella base. Rappresenta un modello esemplare di integrazione tecnica fra artigianato e industria.

Designed by Gae Aulenti and Piero Castiglioni, the Parola lamp features three different kinds of glass working processes: opaline blown glass for the adjustable shade, natural glass for the stem and natural beveled crystal for the base. It is an exemplary model of technical integration between artisan and industrial skills.

La lampe Parola, dessinée par Gae Aulenti et Piero Castiglioni, réunit en un seul objet trois types de verre soumis à différents traitements : soufflé opalin pour l'abat-jour orientable, naturel pour la tige, cristal naturel biseauté pour la base. C'est un modèle exemplaire d'intégration technique entre travail artisanal et usinage industriel.

Bei der Leuchte Parola, die von Gae Aulenti und Piero Castiglioni entworfen wurde, leben in ein und demselben Objekt drei verschiedene Glastypen und -bearbeitungen miteinander: mundgeblasenes Opalglas im orientierbaren Leuchtschirm, Naturglas im Stab, geschliffenes Naturkristallglas im Socket. Sie stellt ein exemplarisches Modell der technischen Integration handwerklicher und industrieller Arbeit dar.

En la lámpara Parola diseñada por Gae Aulenti y Piero Castiglioni conviven en un solo objeto tres tipos y tratamientos del vidrio diferentes: soplado opalino en la pantalla orientable, natural en el pie y cristal natural desbastado en la base. Representa un modelo ejemplar de integración técnica entre manufactura artesanal e industrial.

Technical data pag. 433

- Amber
- White





Floor / Suspension

PASSION

Studio Beretta, 2004

Passion concilia armoniosamente la delicatezza del vetro satinato e la purezza del metallo. Disponibile sospesa e nelle versioni da tavolo e da terra. Caratteristico, in queste ultime, è lo stelo, decentrato rispetto alla base.

Passion stimmt auf harmonische Art die Empfindlichkeit des Opalglases und die Reinheit des Metalls ab. Erhältlich als Pendelleuchte und in den Ausführungen als Tisch- und Bodenleuchte. Charakteristisch ist bei den Tisch- und Bodenleuchten der dezentral positionierte Leuchtenstab.

Passion is a harmonious union of the delicateness of frosted glass and the pureness of metal. Available in suspension, table, and floor versions. In the latter, the stem is placed off centre on the base.

Passion concilia armoniosamente la delicadeza del vidrio satinado y la pureza del metal. Disponible como lámpara de techo y en las versiones de sobremesa y de pie. En estas últimas, el pie descentrado respecto a la base constituye un elemento distintivo.

Passion concilie harmonieusement la délicatesse du verre satiné et la pureté du métal. Disponible en versions suspension, lampe de table ou lampadaire. Les lampadaires se distinguent par leur tige décentrée par rapport à la base.

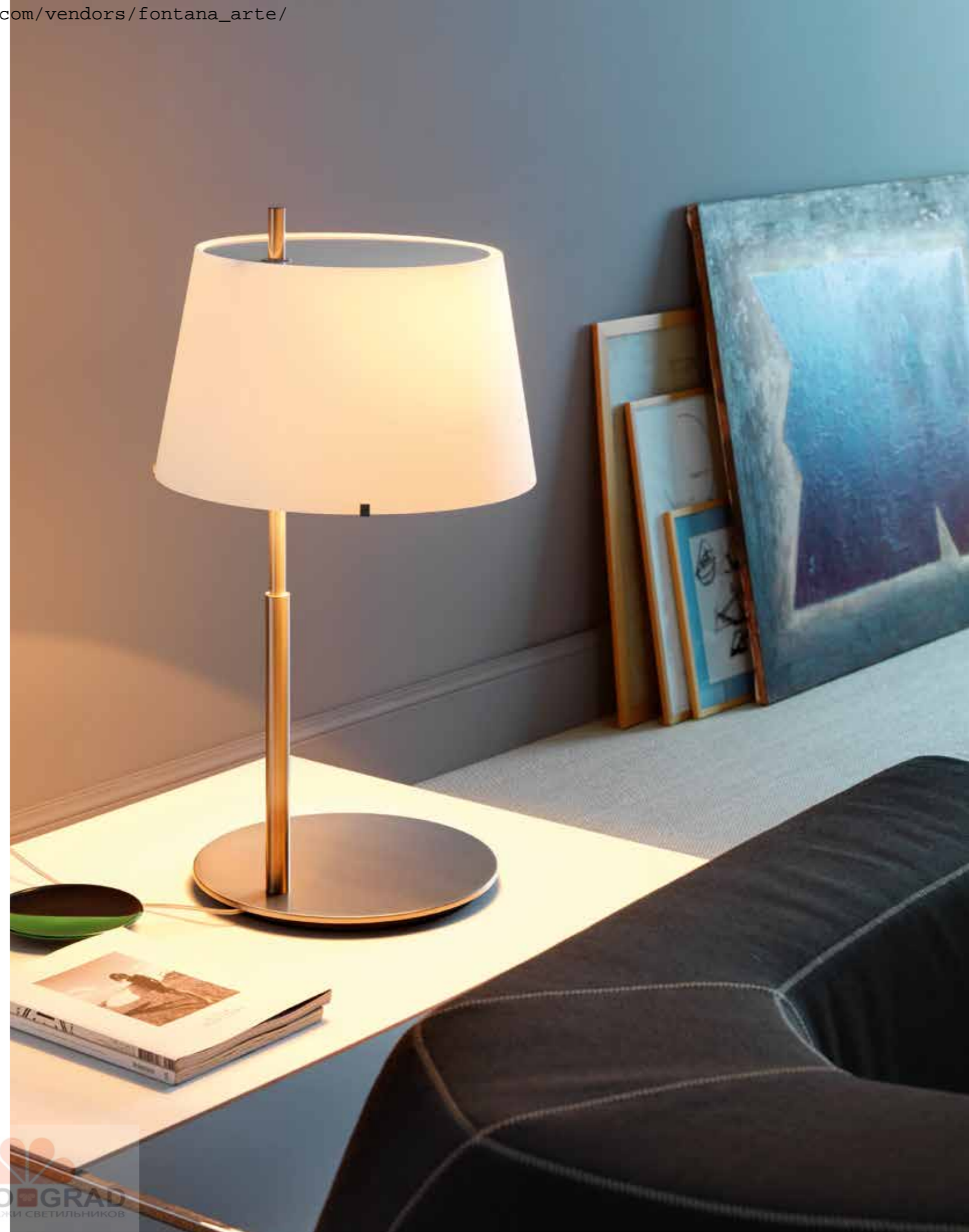



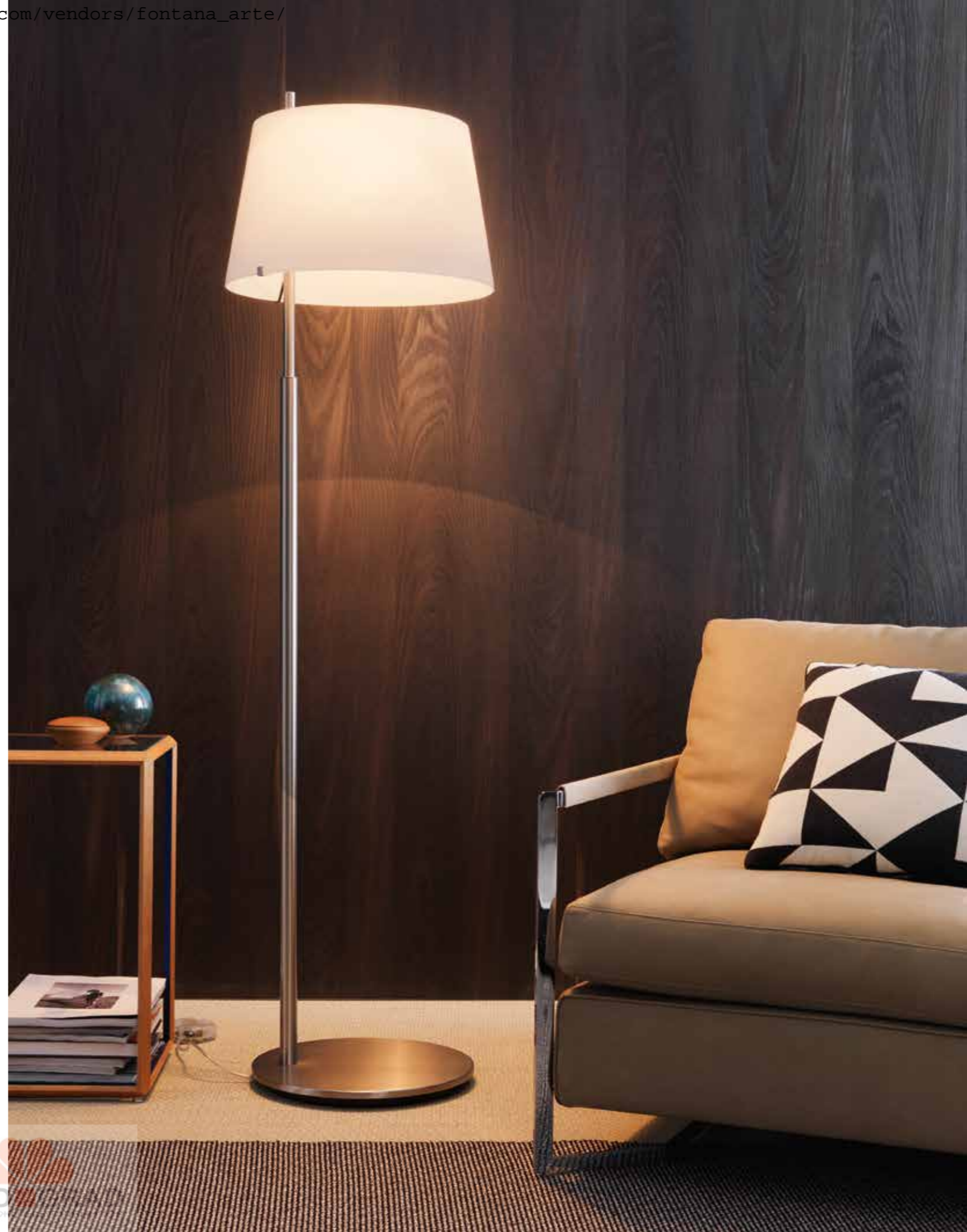

PASSION

PINECONE

Paola Navone, 2016

Pinecone è una lampada da sospensione e da appoggio caratterizzata da un diffusore in vetro soffiato, disponibile nella versione trasparente lucida o bianco latte acidata. Il diffusore viene prodotto mediante l'antica tecnica del vetro soffiato ingabbiato: il maestro vetraio soffia a bocca la bolla vitrea entro una gabbia metallica, che ne contiene la naturale espansione solo in parte. In questo modo il manufatto finale viene in parte trattenuto dalla gabbia e in parte vi sfugge.

Die Pendel- und Tischleuchte Pinecone mit Diffusor aus mundgeblasenem Glas ist in den Ausführungen glanztransparent oder milchweiß geätzt erhältlich. Der Glasdiffusor wird anhand der althergebrachten Technik des Glasblasens in einen Metallkorb hergestellt. Dabei wird das erhitzte Glas direkt in einem Metallkorb geblasen, der die natürliche Ausdehnung nur teilweise einschränkt. Ein Teil des Glasdiffusors entfaltet sich also außerhalb des Korbes und erzeugt ein Spiel der Spannungen.

Technical data pag. 436

Pinecone is a pendant and table lamp mounting a blown glass diffuser, available in the glossy transparent or milky white acid-etched version. The diffuser is manufactured using the ancient caged blown glass technique: the glass maker blows the molten glass blob into a metal cage, which only partly contains the blob's natural expansion. In this way, the glass surface is partly trapped by and partly escapes the cage.

Pinecone es una lámpara de suspensión y de apoyo caracterizada por un difusor de vidrio soplado, disponible en la versión transparente brillante o blanco opalino. El difusor se fabrica mediante la antigua técnica del vidrio soplado enjaulado: el maestro vidriero sopla con la boca la burbuja vitrea dentro de una jaula metálica que contiene la expansión natural sólo en parte. De esta manera, el producto final es retenido en parte por la jaula y en parte se escapa.

Pinecone est aussi bien une suspension qu'une lampe à poser. Caractérisée par un diffuseur en verre soufflé, elle est disponible dans la version transparente et brillante ou dans la version blanc laiteux acidé. Le diffuseur est réalisé selon une ancienne technique du verre soufflé en cage : le maître verrier souffle à la bouche la bulle de verre dans une cage métallique qui en retient partiellement l'expansion naturelle. Le produit final semble ainsi sortir de la cage tout en y restant emprisonné.





PINECONE

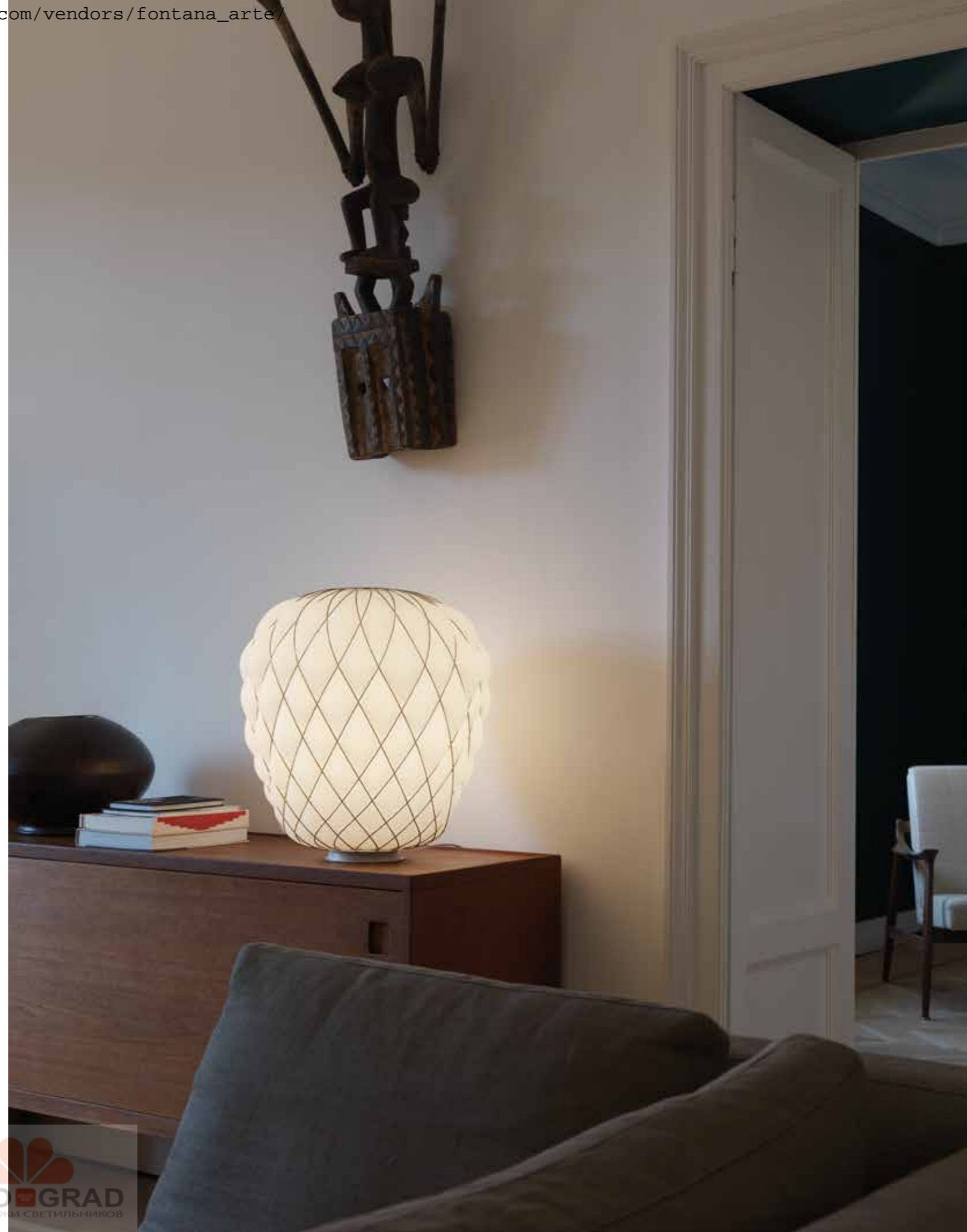

PIRELLONE, PIRELLINA

Gio Ponti, 1967

Pirellone e Pirellina sono da più di 40 anni dei classici intramontabili dell'illuminazione. Una coppia di lastre di vetro curvate e trattenute in posizione da due elementi metallici, alla base e all'estremità superiore: una struttura semplice, ottenuta grazie all'utilizzo di un vetro particolarmente resistente agli urti.

Pirellone und Pirellina sind seit mehr als 40 Jahren zeitlose Beleuchtungsklassiker. Zwei gebogene Glasplatten, die oben und unten von zwei Metallelementen in ihrer Position gehalten werden: eine einfache Struktur, die dank der Verwendung eines besonders stoßfesten Glases erhalten wurde.

Pirellone and Pirellina have been lighting classics for 40 years. Two pieces of curved glass held in place by metal elements at the base and the top: the secret of this simple structure lies in the use of special impact-resistant glass.

Pirellone y Pirellina se distinguen desde hace más de 40 años como clásicos imperecederos de la iluminación. Un par de placas de vidrio curvadas y retenidas en su posición mediante dos elementos metálicos, en la base y en el extremo superior: una estructura simple, obtenida gracias al uso de un vidrio particularmente resistente a los golpes.

Pirellone et Pirellina sont depuis plus de 40 ans des classiques indémodables du monde de l'éclairage. Deux plaques en verre courbées, maintenues par deux éléments métalliques, à la base et au sommet : une structure simple, réalisée en utilisant un verre particulièrement résistant aux chocs.





POLARIS

Marco Acerbis, 2007

Lampada da terra dal design unico, reso possibile grazie ad un innovativo processo di stampaggio rotazionale utilizzato nel settore dell'aeronautica. A seconda dell'angolo di osservazione, il corpo si trasforma e si rinnova, cambiando spessore e larghezza.

A floor lamp with a unique design, made possible thanks to an innovative rotational molding process used in the aeronautics sector. Depending on the viewpoint, the body transforms and renews, changing thickness and width.

Lampadaire au design unique, réalisé grâce à un procédé de rotomoulage innovant issu du secteur aéronautique. Selon l'angle d'observation, le corps se transforme et se renouvelle, en changeant d'épaisseur et de largeur.

Bodenleuchte mit einzigartigem Design, das aufgrund eines in der Luftfahrt verwendeten innovativen Rotationsformverfahrens möglich gemacht wurde. Je nach Betrachtungswinkel verwandelt und erneuert sich der Leuchtenkörper und wechselt Dicke und Breite.

Lámpara de pie de diseño único, realizado con un innovador proceso de moldeo rotacional utilizado en el sector de la aeronáutica. Dependiendo del ángulo de observación, el cuerpo se transforma y se renueva cambiando de espesor y de anchura.

Technical data pag. 437

- Black
- White



PRIMA SIGNORA

Daniela Puppa, 1992

Un treppiede cromato la cui sommità inaspettatamente si infila all'interno di una preziosa sfera in vetro soffiato bianco. Linee essenziali, accostate in modo inedito, per un effetto d'insieme molto equilibrato.

A magnificent globe in white blown glass crowns the chrome-plated tripod. The surprising arrangement of these understated lines produces a very well-balanced result.

Un trépied chromé dont le sommet s'intègre, de façon inattendue, dans une précieuse sphère en verre soufflé blanc. Des lignes essentielles, associées de manière inédite, pour un effet d'ensemble très équilibré.

Ein verchromter Dreifuß, dessen Spitzen unerwarteter Weise in einer kostbaren Kugel aus weißem mundgeblasenen Glas enden. Schlichte, auf neue Weise kombinierte Linien für einen sehr ausgewogenen Gesamteffekt.

Un trípode cromado cuyo ápice se inserta inesperadamente en el interior de una elegante esfera de vidrio soplado blanco. Líneas esenciales, combinadas de modo inédito, con un efecto de conjunto extraordinariamente equilibrado.

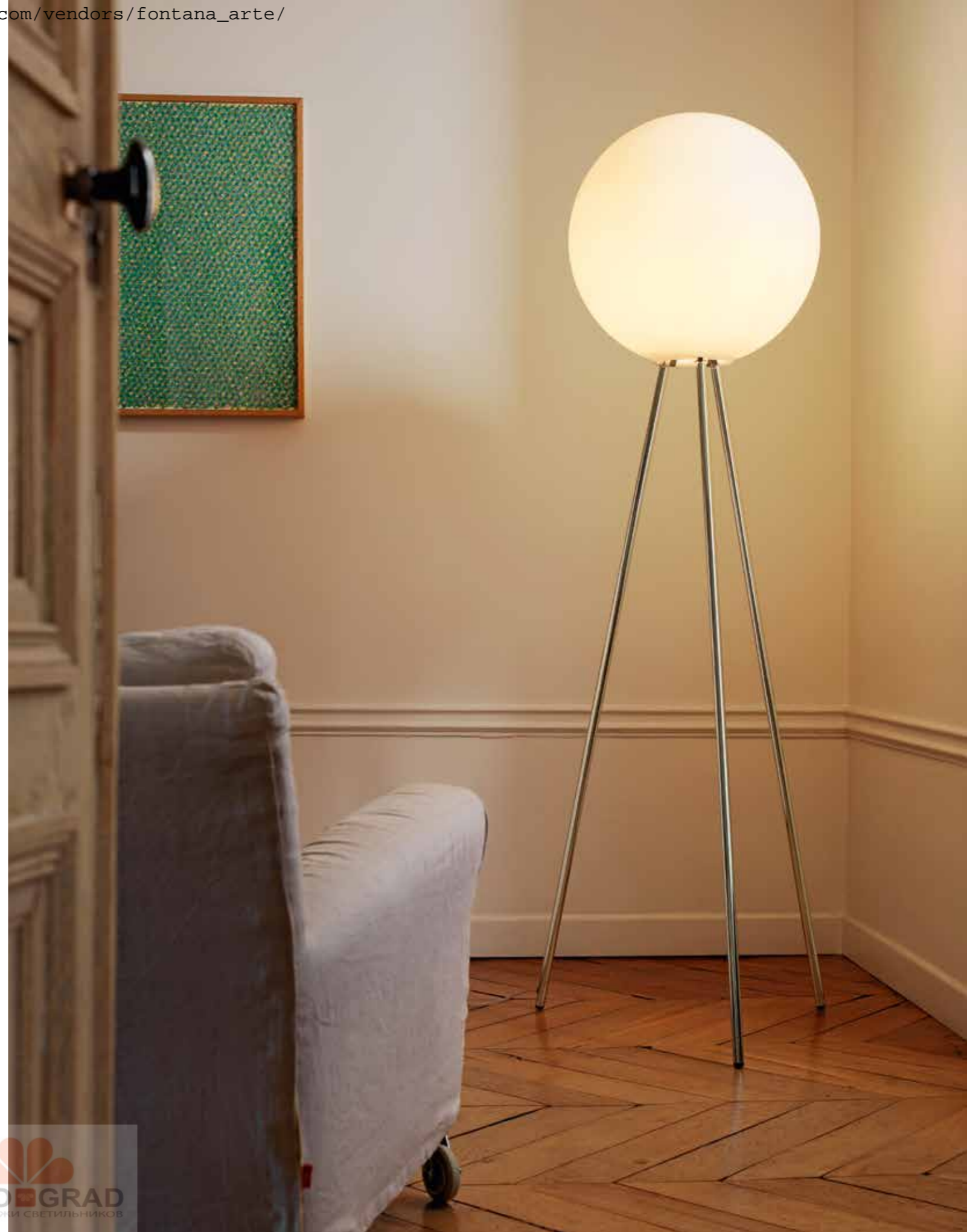

PUDDING

Historical Archive, 1995

Lampada a sospensione con riflettore in alluminio sfaccettato e anodizzato che ricorda uno stampo dolciario. Disponibile anche con disco in vetro temperato trasparente con anello di chiusura.

Suspension lamp with faceted anodized aluminum reflector that looks like a pudding mold. Also available with clear tempered glass disc and edge ring.

Suspension dotée d'un réflecteur en aluminium à facettes anodisé dont la forme évoque celle d'un moule à gâteau. Également disponible avec un disque en verre trempé transparent doté d'un anneau de fermeture.

Pendelleuchte mit einem facettierten und eloxierten Aluminiumreflektor, der an eine Puddingform erinnert. Erhältlich auch mit einer Abschlusscheibe aus transparentem getemperten Glas mit Verschlussring.

Lámpara de techo con reflector de aluminio tallado y anodizado que recuerda un molde para dulces. Disponible también con disco de vidrio templado transparente con anillo de cierre.



RIGA

Paolo Zani, 1995

Applique dal design lineare ed essenziale composta da una fascia in metallo e diffusori in vetro temperato sabbiato. Emissione luminosa verso il basso e verso l'alto.

Wandleuchte mit schlichtem linearen Design, aus einer Struktur aus Metall und Diffusoren aus sandgestrahltem getempertem Glas. Lichtaustritt nach oben und unten.

Wall lamp with linear essential design, comprising a structure in metal and diffusers in sandblasted tempered glass. Downlighting and uplighting.

Lámpara de pared de diseño lineal y esencial compuesta por una estructura de metal y difusores de vidrio templado arenado. Emisión luminosa hacia abajo y hacia arriba.

Applique au design linéaire et essentiel, composée d'une structure en métal et de diffuseurs en verre trempé sablé. Émission lumineuse vers le bas et vers le haut.

Technical data pag. 438

- Stainless steel
- Nickel-plated
- White



Wall



RILUMINATOR

Pietro Chiesa, 2014 edition

Riluminator è la riedizione contemporanea di Luminator, la lampada da terra disegnata da Pietro Chiesa nel 1932, con la quale ha in comune la forma geometrica e l'orientamento della sorgente luminosa, sottolineando la continuità e l'essenzialità di un disegno inconfondibile.

Riluminator ist die moderne Neuauflage der von Pietro Chiesa 1932 entworfenen Bodenleuchte Luminator, mit der sie die geometrische Form und die Ausrichtung der Lichtquelle gemein hat, und unterstreicht die Kontinuität und Essentialität eines unverwechselbaren Designs.

Riluminator is the modern makeover of Luminator, the floor lamp designed by Pietro Chiesa in 1932, which both share the same geometric shape and direction of the light source, highlighting the continuity and minimalism of unmistakable design.

Riluminator es la reedición contemporánea de Luminator, la lámpara de pie diseñada por Pietro Chiesa en 1932, con la que comparte la forma geométrica y la orientación de la fuente luminosa remarcando la continuidad y la esencialidad de un diseño inconfundible.

Riluminator est la réédition contemporaine de Luminator, le lampadaire dessiné par Pietro Chiesa en 1932, dont il reprend la forme géométrique et l'orientation de la source lumineuse, en soulignant la continuité et le caractère essentiel d'un dessin unique.

- Dark grey
- Red
- White

Technical data pag. 441



SARA

Pierluigi Cerri (Gregotti Associati), 1993

Famiglia di lampade da tavolo, terra e parete con montatura in metallo verniciato color alluminio o cromo e diffusore in policarbonato serigrafato bianco. Sara, il cui disegno risale al 1994, segna l'introduzione nei materiali plastici nella collezione FontanaArte.

Tisch-, Boden- und Wandleuchten mit aluminium- oder chromfarbenen lackiertem Metallgestell und Diffusor aus weißem siebgedrucktem Polycarbonat. Sara, deren Design im Jahre 1994 geschaffen wurde, markiert bei der FontanaArte-Kollektion die Einführung von Kunststoffmaterialien.

A family of table, floor and wall lamps with frame in aluminum or chrome color painted metal and diffuser in white screen-printed polycarbonate. Sara was designed in 1994, marking the introduction of plastics into the FontanaArte collection.

Familia de lámparas de sobremesa, de pie y de pared con montura de metal pintado color aluminio o cromo y difusor de policarbonato serigrafiado blanco. Diseñada en 1994, Sara marca la introducción de los materiales plásticos en la colección FontanaArte.

Famille constituée d'une lampe de table, d'un lampadaire et d'une applique avec structure en métal laqué aluminium ou chrome et diffuseur en polycarbonate sérigraphié blanc. Sara, dont le dessin date de 1994, marque l'introduction des matières plastiques dans la collection FontanaArte.



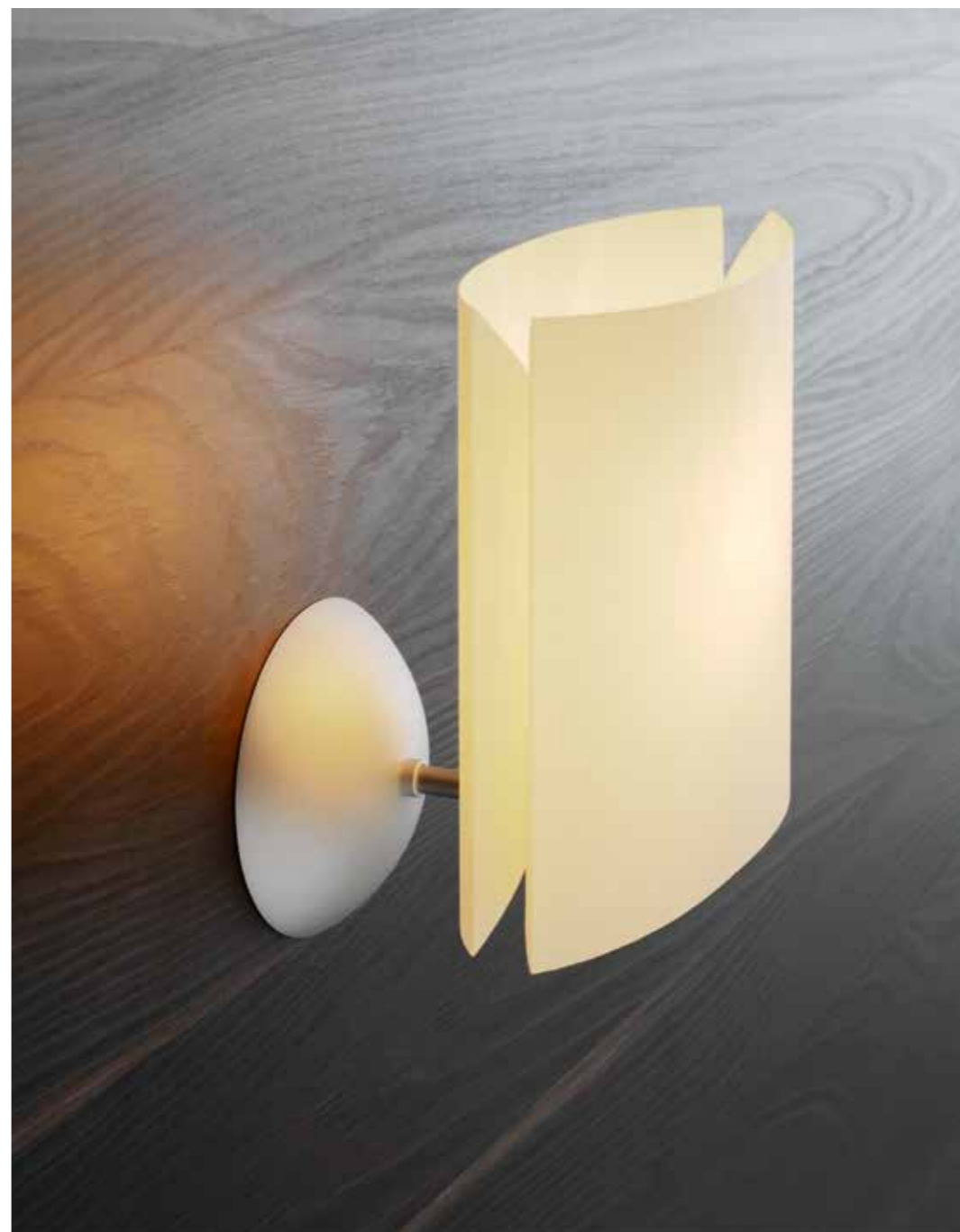

SARA

SCINTILLA

Livio Castiglioni / Piero Castiglioni , 1972

Il sistema Scintilla ha rappresentato una novità assoluta, mettendo insieme il segno essenziale e versatile di una lampada decorativa e una capacità illuminante paragonabile a un sistema tecnico. Il grande successo del sistema porta l'azienda a proporre – nei primi anni Ottanta – la versione da terra, in cui la struttura primaria si aggancia a base e stelo in metallo.

Das System Scintilla stellte eine absolute Neuheit dar; denn es verband das schlichte und vielseitige Zeugnis einer dekorativen Lampe mit einer Leuchtkapazität, die mit einem technischen System vergleichbar ist. Der große Erfolg des Systems führt das Unternehmen dazu, Anfang der 1980er Jahre die Ausführung als Bodenleuchte vorzuschlagen, bei der die Primärstruktur an einem Sockel und Stab aus Metall befestigt wird.

The absolutely novel Scintilla system combines the essential versatility of a decorative lamp and a lighting capacity comparable to a technical system. The great success of this system persuaded the company to design a free-standing version in the early eighties, with the main structure fastened to the base and stem in metal.

El sistema Scintilla ha representado una novedad absoluta que combina el carácter esencial y versátil de una lámpara decorativa con una capacidad de iluminación comparable a la de un sistema técnico. A principios de los años ochenta, el gran éxito del sistema lleva a la empresa a proponer la versión de pie, en la que la estructura primaria se engancha a la base y al pie de metal.

Le système Scintilla a représenté une nouveauté absolue, alliance du design essentiel et polyvalent d'une lampe décorative et de la capacité d'éclairage propre à un système technique. Le grand succès du système conduit l'entreprise à proposer – au début des années quatre-vingt – la version lampadaire, où la structure primaire se fixe à une base et une tige en métal.

- Chrome-plated
- Nickel-plated
- White

Technical data pag. 442







SERPENTINE

Gabi Peretto, 2011

Un'onda luminosa che fluttua nello spazio dando vita a un gioco di luci inedito. 364 Led posizionati nella parte inferiore della lampada garantiscono un sorprendente effetto di luce e movimento.

A luminous wave floating in space and bringing life to unprecedented lighting effects. 364 Leds in the underside of the lamp guarantee a surprising result in terms of light and movement.

Une vague lumineuse qui flotte dans l'espace en créant un jeu de lumière inédit. 364 Led intégrées dans la partie inférieure de la lampe créent un surprenant effet de lumière et de mouvement.

Eine im Raum schwebende Lichtwelle, die einem ganz neuen Lichterspiel Leben verleiht. 364 Leds sind im unteren Teil der Leuchte angebracht und garantieren einen überraschenden Effekt von Licht und Bewegung.

Una onda luminosa que fluctúa en el espacio dando vida a un inédito juego de luces. Los 364 Ledes instalados en la parte inferior de la lámpara garantizan un sorprendente efecto de luz y movimiento.



SILLABA

Piero Castiglioni, 1988

Pensata sia per l'installazione a parete che a soffitto, Sillaba unisce discrezione e purezza arredando qualsiasi interno con la sua presenza essenziale.

Für eine Installation an der Wand oder Decke gedacht, verbindet Sillaba Diskretion und Reinheit und richtet mit ihrer schlichten Präsenz jeden Raum ein.

Designed for either wall or ceiling installation, Sillaba combines discretion and pureness, furnishing any room with its minimal presence.

Pensada tanto para la instalación de pared como de techo, Sillaba aún discreción y pureza decorando cualquier ambiente interior con su presencia esencial.

Applique ou plafonnier, Sillaba allie discrétion et pureté et éclaire n'importe quel intérieur de sa présence essentielle.



Wall



SILLABA

SILLABONE

Piero Castiglioni, 1988

Versione grande di Sillaba, è una lampada da parete e soffitto con diffusore in vetro sabbiato.

The large version of Sillaba, this is a wall and ceiling lamp with diffuser in sand-blasted white glass.

Déclinaison grand format de Sillaba, c'est une applique et plafonnier avec diffuseur en verre blanc sablé.

Bei der großen Ausführung von Sillaba handelt es sich um eine Wand- und Deckenleuchte mit einem sandgestrahlten weißen Glasdiffusor.

Versión grande de Sillaba, es una lámpara de pared y plafón con difusor de vidrio blanco arenado.



SIMPLE WHITE

Historical Archive, 1994

Lampada da parete con montatura in metallo verniciato bianco e diffusore in vetro curvato bianco opale o stampato.

A wall lamp with white painted metal frame and diffuser in opal white or printed curved glass.

Applique avec structure en métal laqué blanc et diffuseur en verre bombé blanc opale ou moulé.

Wandleuchte mit weiß lackiertem Metallgestell und Diffusor aus opalweißem gebogenem oder gepresstem Glas.

Lámpara de pared con montura de metal pintado blanco y difusor de vidrio curvado opalino o grabado.

Technical data pag. 446

- Opaline white
- Pressed

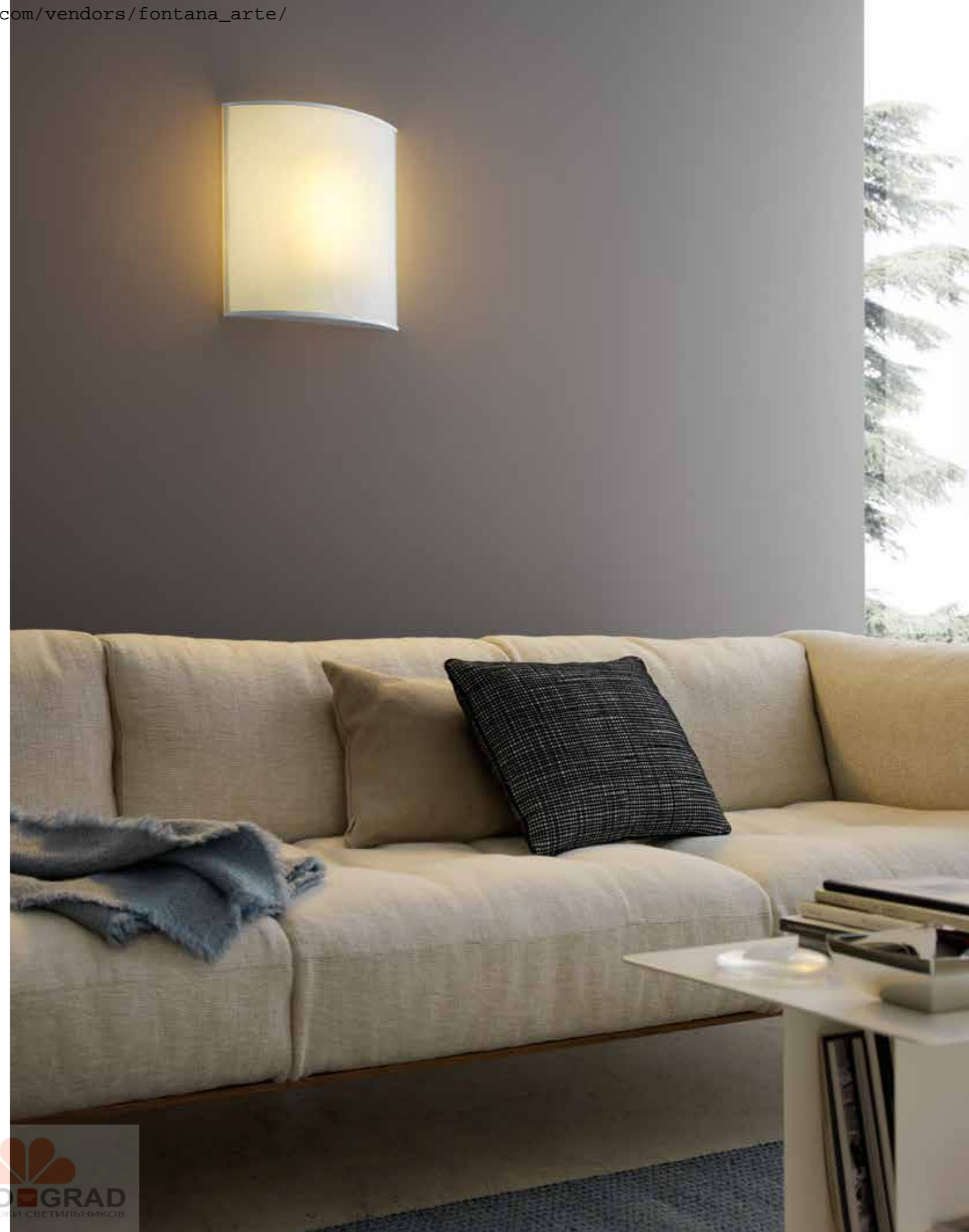

SIMPLICITY

Gabi Peretto, 2010

Lampada da parete disponibile in tre differenti misure. Montatura in acciaio verniciato lucido bianco e diffusori in vetro temperato e sabbato.

Wandleuchte, erhältlich in drei verschiedenen Größen. Gestell aus glänzend weiß lackiertem Stahl und Diffusoren aus getempertem und sandgestrahltem Glas.

A wall lamp available in three different sizes. Frame in glossy white painted steel and diffusers in sandblasted tempered glass.

Lámpara de pared disponible en tres medidas diferentes. Montura de acero pintado brillante blanco y difusores de vidrio templado y arenado.

Applique disponible en trois dimensions. Structure en acier laqué blanc brillant et diffuseurs en verre trempé et sablé.





SOLE

Dino Amato, 2011

Progetto di illuminazione sia tecnico che decorativo. Design essenziale dal "cuore" tecnologico con una scheda Led particolarmente evoluta con un'elevata efficienza luminosa regolabile e a risparmio energetico. Ingombri molto ridotti e facilità di montaggio sia a parete che a soffitto.

Technisches wie dekoratives Beleuchtungsprojekt. Schlichtes Design mit dem technologischen „Herz“ einer besonders hochentwickelten Led-Platine mit einer hohen regulierbaren Lichtausstrahlung und Energieeinsparung. Stark reduzierte Maße und einfache Montage an Wand und Decke.

A lighting project that is both technical and decorative. Essential design with a techno 'heart' thanks to a highly evolved Led board with adjustable, energy-saving, high luminous efficiency. Tiny and easy to install on walls or ceilings.

Proyecto de iluminación tanto técnico como decorativo. Diseño esencial de «corazón» tecnológico con una tarjeta Led particularmente evolucionada que garantiza una elevada eficiencia luminosa regulable junto a un ahorro energético. Volúmenes muy reducidos y facilidad de montaje, tanto en la pared como en el techo.

Projet d'éclairage à la fois technique et décoratif. Design essentiel au «cœur» technologique avec une carte à Led particulièrement évoluée assurant une haute efficacité lumineuse réglable et l'économie d'énergie. Encombrements très réduits et facilité de montage aussi bien au mur qu'au plafond.

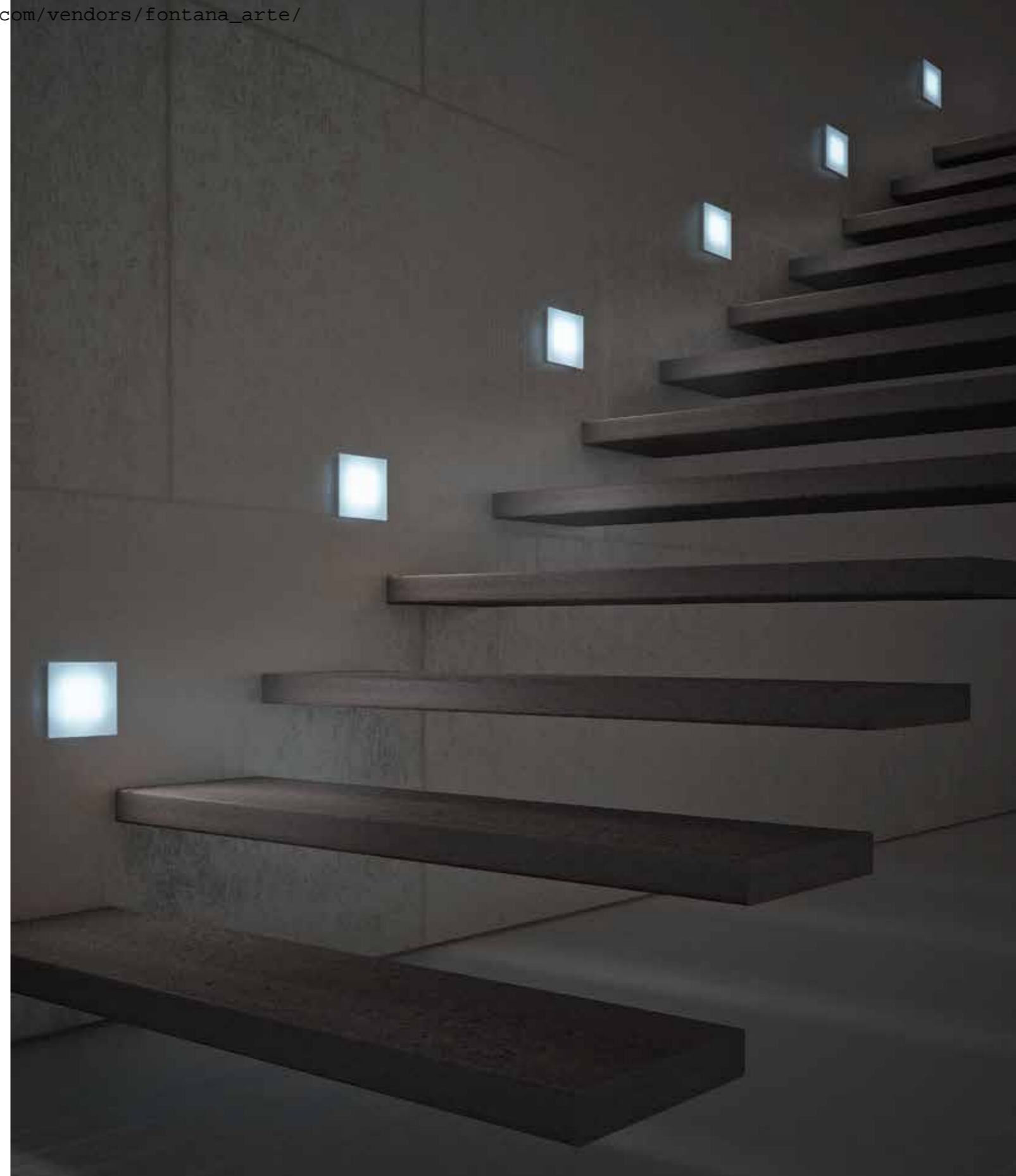

THOR

Luciano Pagani / Angelo Perversi, 2000

Lampada da tavolo con montatura in metallo verniciato bianco e diffusore in vetro soffiato bianco opalino.

A table lamp with white painted metal frame and diffuser in opaline white blown glass.

Lampe de table avec structure en métal laqué blanc et diffuseur en verre soufflé blanc opalin.

Tischleuchte mit weiß lackiertem Metallgestell und Diffusor aus opalweißem mundgeblasenem Glas.

Lámpara de sobremesa con montura de metal pintado blanco y difusor de vidrio soplado blanco opalino.



TUBO LED

FontanaArte Design Lab, 2011

Semplicità e linearità espresse da un cilindro sospeso in vetro borosilicato trasparente. Una volta acceso, la luce diventa protagonista indiscussa della scena.

Simplicity and linearity conveyed by a cylinder suspended in clear borosilicate glass. When switched on, the light is the undisputed main player.

La simplicité et la linéarité sont exprimées par un cylindre suspendu en verre borosilicate transparent. Une fois qu'elle est allumée, la lumière impose dans l'espace sa forte présence décorative.

Einfachheit und Linearität, die durch einen hängenden Zylinder aus transparentem Borosilikatglas ausgedrückt werden. Sobald er eingeschaltet wird, wird das Licht zum unbestrittenen Star der Szene.

Simplicidad y linealidad expresadas mediante un cilindro suspendido de vidrio borosilicato transparente. Una vez encendido, la luz se transforma en la protagonista indiscutible de la escena.



UOVO

Historical Archive, 1972

Una forma naturale che da sempre è simbolo di perfezione, in cui convivono armonicamente simmetria e asimmetria. Un'idea ironica che conquista. Come in natura, anche nella lampada Uovo il guscio è esempio assoluto di leggerezza: una forma elegante in vetro soffiato bianco satinato che diffonde uniformemente una calda luce avvolgente. Disponibile anche nella versione outdoor.

Eine natürliche Form, die seit jeher als Symbol der Perfektion gilt und in der Symmetrie und Asymmetrie harmonisch zusammenleben. Eine ironische Idee, die erobert. Wie in der Natur so ist die Schale auch bei der Leuchte Uovo (it. Ei) ein absolutes Beispiel für Leichtigkeit: eine elegante Form aus weißem mundgeblasenem und satiniertem Glas, die ein gleichmäßiges warmes und einhüllendes Licht verbreitet. Erhältlich auch in der Version für den Außenbereich.

A natural shape that has always been a symbol of perfection, the harmonious combination of symmetry and asymmetry. An ironic idea that is a winner. As in nature, also in the Uovo lamp, the shell is the epitome of lightness: an elegant shape in frosted white blown glass that evenly diffuses a warm, welcoming light. Also available in an outdoor version.

Una forma natural que desde siempre simboliza la perfección y en la que conviven armónicamente simetría y asimetría. Una idea irónica que conquista. Como en la naturaleza, la «cáscara» de la lámpara Uovo es un ejemplo de absoluta ligereza: una forma elegante de vidrio soplado blanco satinado que difunde una cálida luz uniforme y envolvente. Disponible también en versión para exteriores.

Une forme naturelle, symbole de perfection depuis toujours, où cohabitent harmonieusement la symétrie et l'asymétrie. Une idée ironique qui séduit. Comme dans la nature, la « coquille » de la lampe Uovo est un exemple d'absolue légèreté : une forme élégante en verre soufflé blanc satiné qui diffuse uniformément une lumière chaude et enveloppante. Également disponible dans une version pour l'extérieur.







VELO

Franco Raggi, 1988

Un sottile foglio di vetro sospeso, una presenza quasi eterea sostenuta da morsetti in alluminio agganciati a tiranti in acciaio. Una forma essenziale: uno schermo rettangolare la cui parte centrale è in vetro sabbiato, per evitare l'abbagliamento. Velo è un progetto ottenuto per sottrazione di peso, di materia e di forma, per un risultato estetico dotato di rigorosa unità stilistica.

Ein dünnes, hängendes Glasblatt, eine fast ätherische Präsenz, die von Aluminiumklemmen gehalten wird, welche an Stahlzugseilen eingehängt sind. Eine wesentliche Form: ein rechteckiger Schirm, dessen zentraler Teil aus sandgestrahltem Glas hergestellt ist, um eine Blendung zu vermeiden. Velo ist ein Entwurf, der durch Subtraktion von Gewicht, Materie und Form für ein ästhetisches Ergebnis mit strenger stilistischer Einheit erhalten wurde.

A slim, almost ethereal sheet of suspended glass, supported by aluminum clamps hooked onto steel wire ties. An essential shape: a rectangular screen with sandblasted glass at the centre to prevent glare. The concept behind Velo was to subtract weight, matter and form to achieve an aesthetic result of painstaking stylistic consistency.

Una fina hoja de vidrio suspendido, una presencia casi etérea sostenida con abrazaderas de aluminio enganchadas a tirantes de acero. Una forma esencial: una pantalla rectangular cuya parte central es de vidrio arenado, para evitar el deslumbramiento. Velo es un proyecto obtenido por sustracción de peso, de materia y de forma, para lograr un resultado estético dotado de rigurosa unidad estilística.

Une fine feuille de verre suspendue, une présence impalpable soutenue par des crochets en aluminium fixés à des tirants d'acier. Une forme essentielle : un écran rectangulaire dont la partie centrale est en verre sablé, pour éviter l'éblouissement. Velo est un projet obtenu par soustraction de poids, de matière et de forme, pour un résultat esthétique caractérisé par une rigoureuse unité stylistique.



Wall



VELO

VERTIGO

Marco Acerbis, 2005

Il gioco di spigoli e facce che caratterizza questa lampada da terra a luce indiretta deriva dall'applicazione inedita di un sottile foglio di alluminio piegato. La struttura è montata su una base in acciaio e può essere ruotata fino a 320 gradi.

This indirect light floor lamp with its distinctive sharp corners and edges is the result of folding a fine sheet of aluminum. The structure is mounted on a steel base and can be rotated 320°.

Le jeu d'arêtes et de facettes qui caractérise ce lampadaire à lumière indirecte est obtenu grâce à l'application inédite d'une fine feuille d'aluminium plié. La structure est montée sur une base en acier et peut pivoter sur 320 degrés.

Das Spiel von Kanten und Flächen, das diese Bodenleuchte für indirekte Beleuchtung kennzeichnet, stammt aus der völligen neuen Anwendung eines dünnen gebogenen Aluminiumblechs. Die Struktur steht auf einem Stahlsockel und kann um bis zu 320 Grad gedreht werden.

El juego de aristas y caras que caracteriza a esta lámpara de pie de luz indirecta deriva de la inédita aplicación de una fina hoja de aluminio plegado. La estructura está montada sobre una base de acero y puede efectuar una rotación de hasta 320°.

Technical data pag. 455

- Black
- Mirror
- White

Best of Year Award by Interior Design 2007
ADI Design Index 2006





VITRO

Emmanuel Babled, 2014

Realizzata in polimero plastico, Vitro riproduce la trasparenza e la lucentezza del cristallo molato ma, contrariamente a quest'ultimo, possiede elevatissimi requisiti di robustezza e comfort. Utilizzabile anche all'esterno, si monta a parete, plafone e anche incassata.

Aus Polymer hergestellt, reproduziert Vitro die Transparenz und Brillanz geschliffenen Kristalls, besitzt aber, im Gegensatz zu letzterem, sehr hohe Anforderungen an Robustheit und Komfort. Sie kann auch im Außenbereich verwendet werden und wird an der Wand, der Decke und auch halb eingebaut montiert.

In plastic polymer, Vitro reproduces the transparency and brilliance of cut glass but, unlike the latter, it has very high requisites of sturdiness and comfort. It can also be used outdoors, installed on walls, ceilings or even as recessed lighting.

Realizada en polímero plástico, Vitro reproduce la transparencia y el brillo del vidrio desbastado pero, a diferencia de este último, garantiza elevadísimos niveles de robustez y confort. Utilizable también en ambientes exteriores, se monta en la pared, como plafón y empotrada.

Réalisée en polymère plastique, Vitro reproduit la transparence et la brillance du cristal meulé mais possède, contrairement à ce dernier, d'excellentes qualités de robustesse et de confort. S'utilise également à l'extérieur et peut être fixée au mur ou au plafond ou bien encastrée.

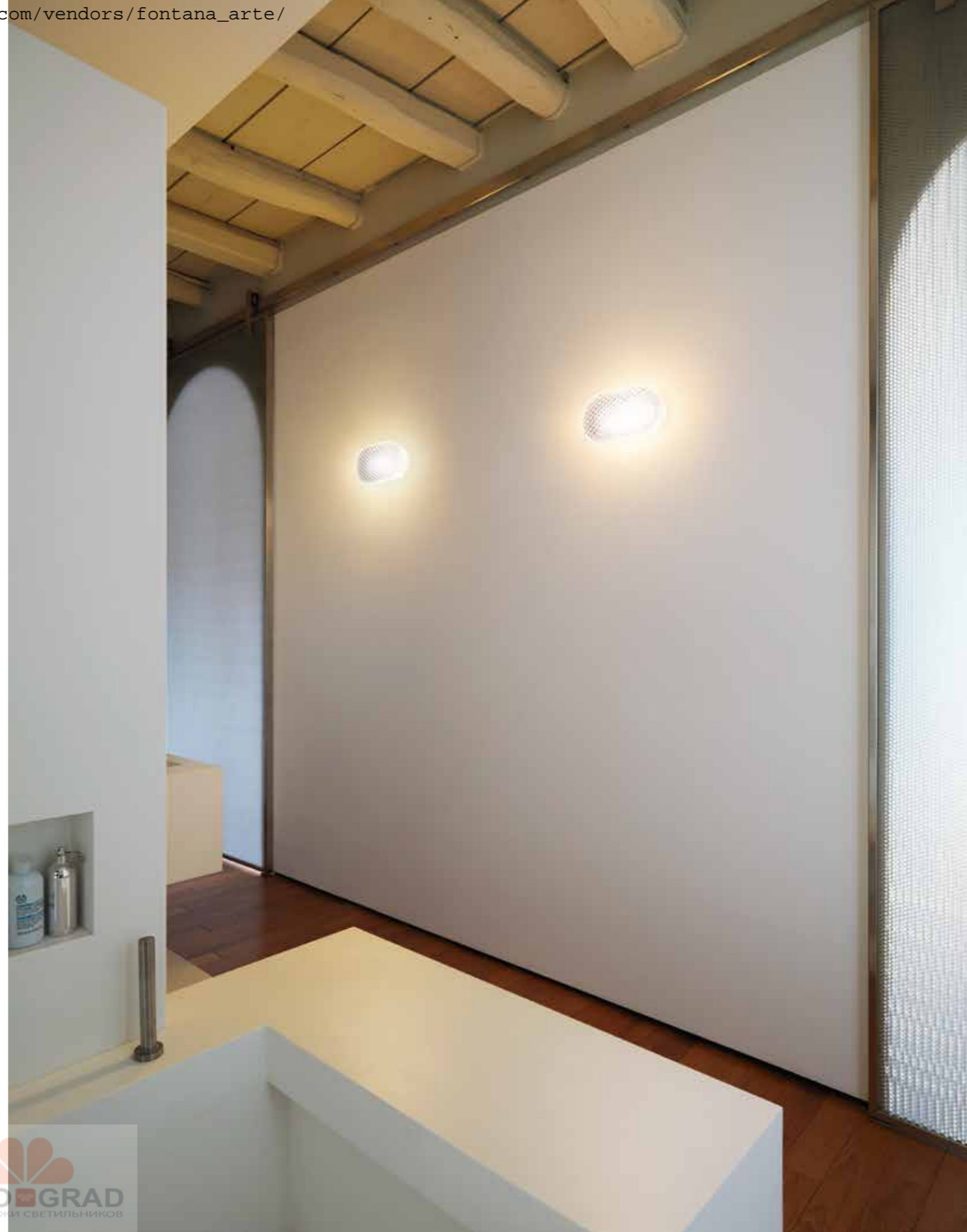



VOLÉE

Odo Fioravanti, 2015

Volée è un apparecchio di illuminazione a Led di ultima generazione, nel quale la ricerca formale si coniuga con l'innovazione tecnologica. Caratterizzato da un disegno essenziale, si accende con un gesto quasi tennistico: un semplice movimento della mano sotto la testa attiva un dispositivo elettronico che accende e spegne la lampada senza che essa venga toccata. Un sensore a sfioramento posto sopra la testa consente la regolazione del flusso luminoso su quattro diversi livelli di intensità (40%, 60%, 100%, 0%). Un sistema Time Out spegne automaticamente la lampada dopo 5 ore di funzionamento.

Volée ist eine Led-Leuchte der neuesten Generation in der die formale Forschung mit der technischen Innovation kombiniert wurde. Volée schaltet sich mit einer dem Tennissport entnommenen Geste ein: eine einfache Handbewegung unter dem Kopf des Gerätes aktiviert die Elektronik, die die Leuchte ein- und ausschaltet, ohne dass sie berührt wird, während der Berührungssensor über dem Kopf die Einstellung des Lichtstroms auf vier verschiedene Helligkeitsniveaus (0%, 40%, 60%, 100%) ermöglicht. Das integrierte Time Out-System erlaubt das automatische Ausschalten der Leuchte nach 5 Betriebsstunden.

Volée is a Led luminaire of the latest generation, in which the formal research is combined with technological innovation. Featured by an essential design, Volée switches on with an almost tennis-style gesture: a simple wave of the hand under the head of this lamp activates an electronic device that switches the light on or off without any contact. A touch sensor over the head allows the flow of light to be regulated to four different levels of intensity (40%, 60%, 100%, 0%). A Time Out system automatically switches the lamp off after it has been on for 5 hours.

Volée es una lámpara Led de última generación, en la que el formalismo se une a la innovación tecnológica. Se caracteriza por un diseño limpio y esencial. Volée se enciende con un gesto casi tenístico: un simple movimiento de la mano debajo de la cabeza activa un dispositivo electrónico que la enciende y la apaga sin tocarla, mientras que el sensor táctil ubicado sobre la cabeza permite regular la luz gracias a sus cuatro niveles de intensidad (0%, 40%, 60%, 100%). Además, un sistema Time Out permite el apagado automático de la lámpara pasadas las 5 horas de funcionamiento.

- white
- light gray
- dark gray
- fluorescent yellow

Technical data pag. 457/458





Table / Wall

WIG

Chris Hardy, 2011

Una corolla di petali curvati in metallo verniciato bianco lucido fanno di questa a lampada a sospensione un oggetto dal forte carattere che si adatta perfettamente al ruolo di protagonista dell'ambiente.

A corolla of curved petals in glossy white painted metal give this hanging lamp great character, perfect for a leading role in interior decor.

Une corolle de pétales courbées en métal laqué blanc brillant fait de cette suspension un objet à forte personnalité qui s'adapte parfaitement à la place prépondérante qu'elle occupe dans l'espace.

Eine Blütenblätterkrone aus glänzend weiß lackiertem Metall machen diese Pendelleuchte zu einem Objekt mit starkem Charakter, das sich in seinem Ambiente perfekt an die Rolle des Protagonisten anpasst.

Una corola de pétalos curvados de metal pintado blanco brillante convierte a esta lámpara de techo en un objeto de carácter fuerte que se adapta perfectamente al rol de protagonista del ambiente.



YUMI

Shigeru Ban, 2011

Una sintesi assoluta destinata a diventare un nuovo classico universale. Un segno essenziale incontra una struttura resistente e leggera in materiale composto da fibra di vetro e fibra di carbonio. 170 Led dimmerabili e integrati nella struttura della lampada ne garantiscono il minimo ingombro e valorizzano la continuità del segno.

Eine absolute Synthese, die dazu bestimmt ist, ein neuer universaler Klassiker zu werden. Ein schlichtes Zeichen trifft auf eine widerstandsfähige und leichte Struktur aus Glasfaser und Kohlefaser. 170 LEDs, dimmbar und in die Lampenstruktur integriert, garantieren einen minimalen Raumbedarf und werten die Kontinuität des Zeichens auf.

Absolute synthesis destined to become a new universal classic. Essential design meets a sturdy lightweight structure in a composite of fiberglass and carbon fiber. The 170 dimmable Leds that are part of the lamp's structure mean it takes up very little space and enhance the flow of its design.

Una síntesis absoluta destinada a convertirse en un nuevo clásico universal. Un signo esencial encuentra una estructura resistente y ligera realizada en un material compuesto por fibra de vidrio y fibra de carbono. 170 Ledes con dimer integrados en la estructura de la lámpara garantizan el mínimo volumen y valorizan la continuidad del signo.

Une synthèse absolue destinée à devenir un nouveau classique universel. Un trait essentiel rencontre une structure résistante et légère réalisée en composite de fibre de verre et fibre de carbone. 170 Led à intensité variable, intégrées dans la structure de la lampe en garantissent l'encombrement minimal et mettent en valeur la continuité du trait.

- Black
- Red
- White

Technical data pag. 459

iF Gold Product Design Award 2014
Good Design Award 2013
ADI Design Index 2012
Best of Year Award by Interior Design 2012



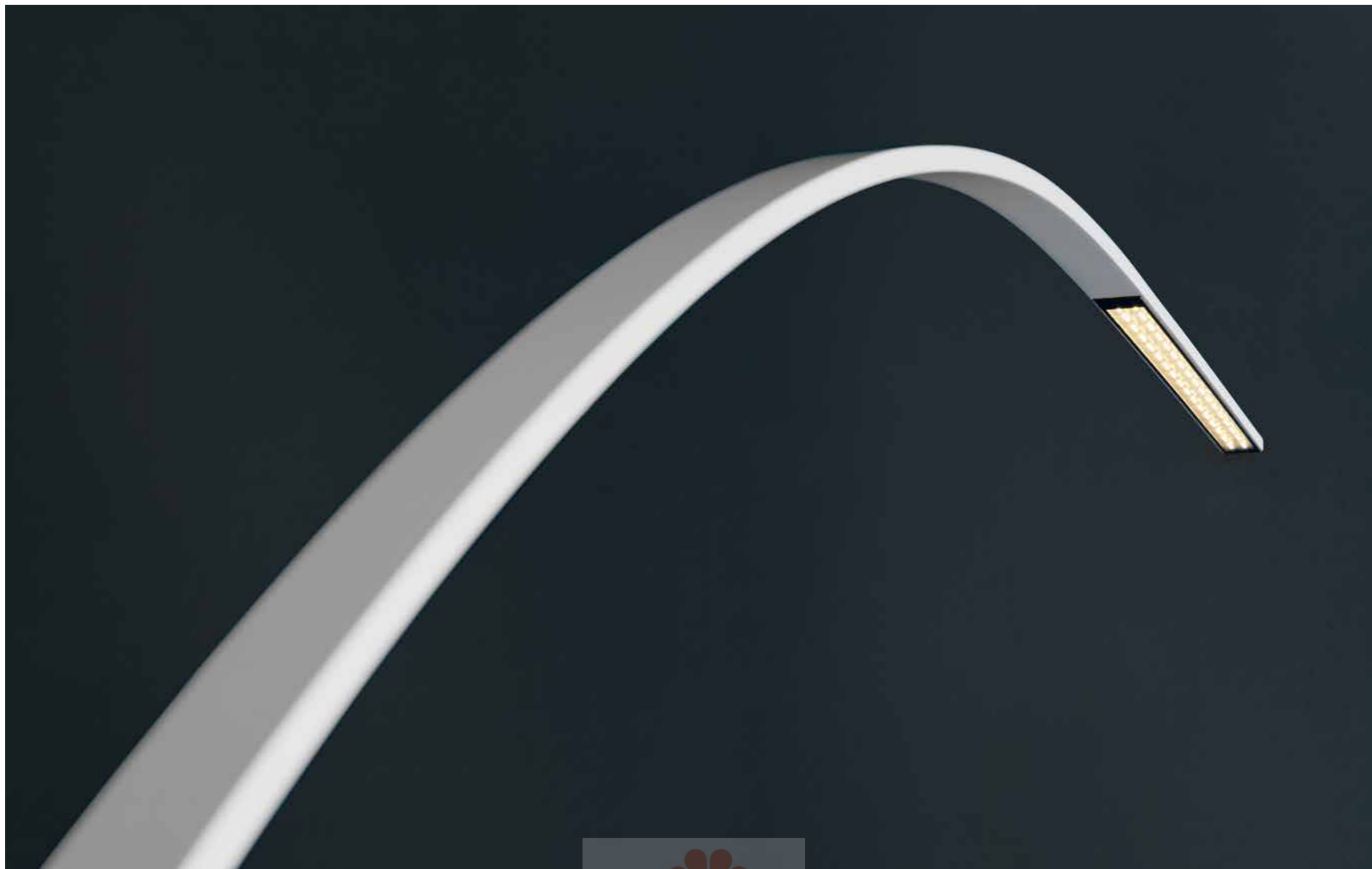



YUPIK

Form Us With Love, 2013

Dotata di 5 metri di cavo, può essere utilizzata come una torcia ma anche posizionata su un tavolo o a terra, diritta con la fonte luminosa rivolta verso l'alto o inclinata, per illuminare una parete. Può inoltre essere appesa grazie ad un gancio che consente al cavo di essere piegato e formare un asola.

Mit ihren 5 m Kabel kann sie eben wie eine Taschenlampe eingesetzt werden, aber auch auf einem Tisch oder am Boden aufgestellt werden, gerade mit der Lichtquelle nach oben oder schräg, zum Beleuchten einer Wand. Darüber hinaus kann sie durch einen Haken, der es ermöglicht, das Kabel zu biegen und eine Schlaufe zu bilden, auch aufgehängt werden.

Fitted with 5 metres of cable, it can be used as a torch, but also placed on a table or on the ground, stood with the light source pointing upwards or laid on one side to illuminate a wall. It can even be hung up, thanks to a hook around which the cable can be twisted to form a loop.

Dotada de 5 metros de cable, se puede utilizar como una linterna, pero también sobre una mesa o en el suelo, recta con la fuente luminosa orientada hacia arriba o inclinada para iluminar una pared. También se puede colgar, gracias a un gancho que permite doblar el cable formando un lazo.

Avec ses 5 mètres de câble, elle peut non seulement être utilisée comme une torche mais aussi placée sur une table ou au sol, droite avec la source lumineuse orientée vers le haut ou inclinée pour éclairer un mur. Elle peut également être suspendue grâce à un crochet qui permet au câble d'être plié et de former un nœud coulant.

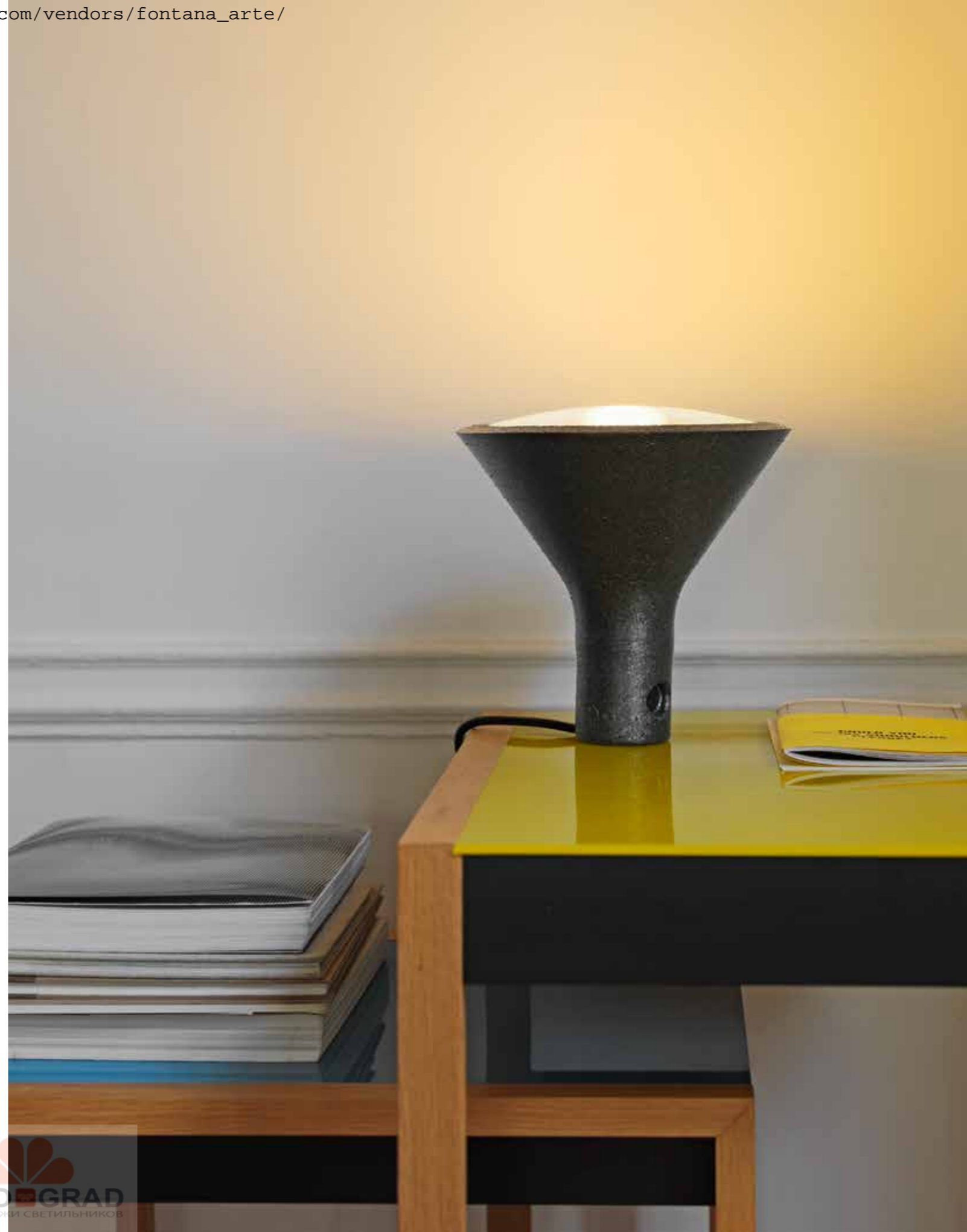

YVES

Gabi Peretto, 2009

Applique dal design sofisticato che diffonde una luce calda e indiretta grazie alla struttura in pressofusione di alluminio verniciata o spazzolata.

Wandleuchte mit raffiniertem Design, die dank der lackierten oder gebürsteten Struktur aus Aluminium-Druckguss ein indirektes warmes Licht verbreitet.

A sophisticated wall lamp that diffuses warm, indirect light thanks to its structure in die-cast aluminum, painted or brushed.

Lámpara de pared de diseño sofisticado que difunde una luz cálida e indirecta gracias a su estructura de aluminio moldeado a presión pintada o cepillada.

Applique au design sophistiqué qui diffuse une lumière chaude et indirecte grâce à la structure en aluminium moulé sous pression, laquée ou brossée.

Technical data pag. 460

- Brushed aluminum
- White

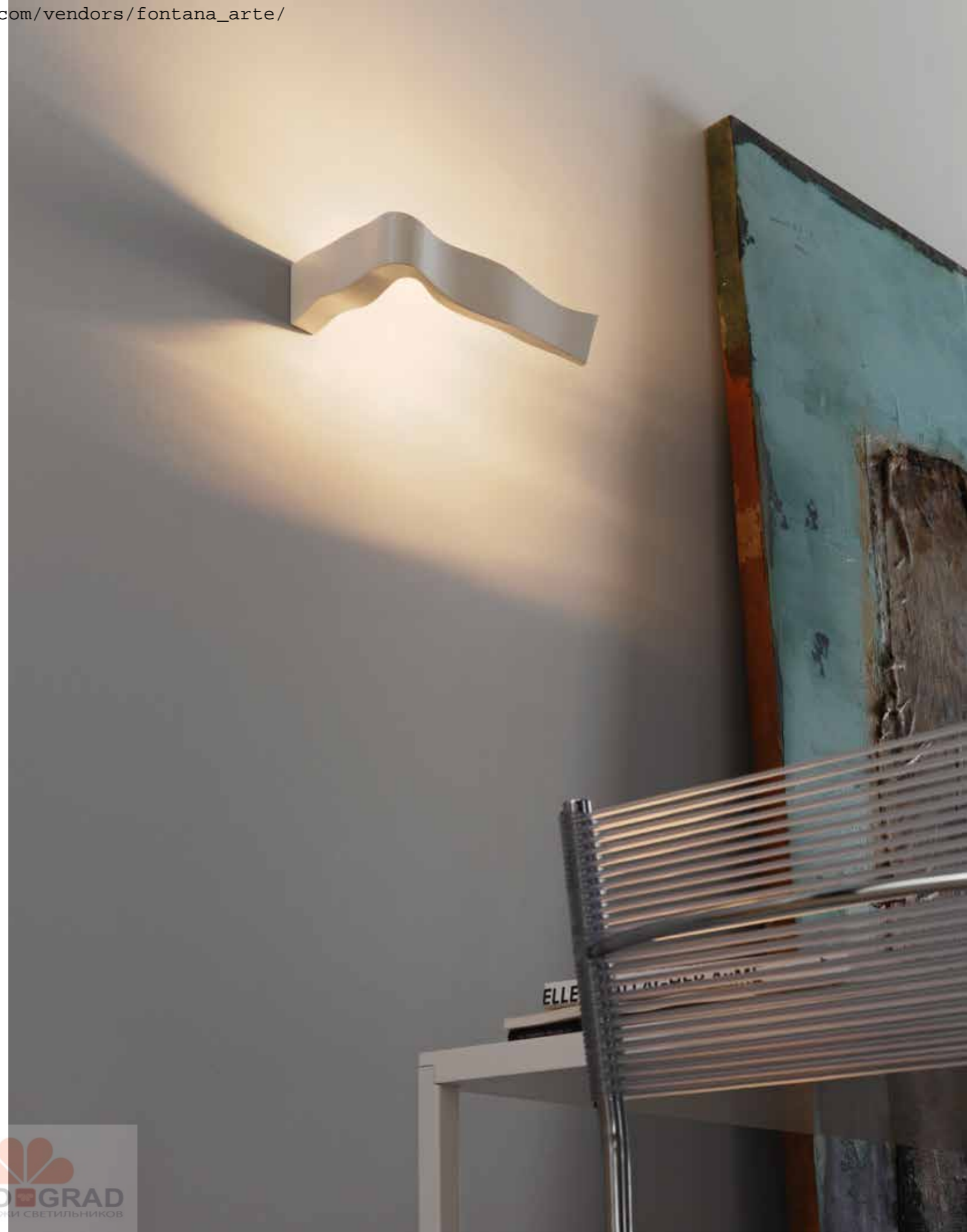

LIGHTS TO LIVE / ARCHITECTURAL

IGLOO SYSTEM

Studio Klass, 2014

Igloo rappresenta una grande innovazione nel segmento degli spot light a sospensione. E' un sistema di illuminazione modulare autoportante che, grazie a connessioni elettromeccaniche, curve e distanziali, consente il collegamento consecutivo fino a 100 moduli con una singola alimentazione.

Igloo stellt eine große Innovation im Segment der Pendelstrahler dar. Es ist ein selbsttragendes modulares Beleuchtungssystem, das aufgrund elektromechanischer Verbindungen, Winkeln und Abstandshaltern, die Verbindung in Reihe von bis zu 100 Modulen mit einer einzigen Stromversorgung möglich macht.

Igloo represents the great innovation in the segment of hanging spotlights. It is a modular, self-supporting lighting system that features a series of electromechanical connections, curves and spacers for consecutive linking of several units (up to one hundred) to just one power point.

Igloo representa una gran innovación en el segmento de los focos de techo. Se trata de un sistema de iluminación modular autoportante que, gracias a sus conexiones electromecánicas, curvas y distanciadores, permite conectar de modo consecutivo hasta 100 módulos con una sola alimentación.

Igloo constitue une grande innovation dans le secteur des spots à suspension. C'est un système d'éclairage modulaire autoporteur qui, grâce à des connexions électromécaniques, avec des angles et des entretoises, permet de connecter sans interruption jusqu'à cent modules avec une seule source d'alimentation.





Suspension



SLOT

David Chipperfield, 2005

Serie di lampade da incasso per parete o soffitto per un'illuminazione a luce indiretta. L'apparecchio ha una struttura in metallo, verniciata a polveri epossodiche colore bianco opaco in cui sono alloggiata una o più lampade fluorescenti dimmerabili. L'essenzialità del design consente un effetto luminoso simile ad un taglio di luce su una parete.

Einbauleuchten-Serie für Wand oder Decke für indirekte Beleuchtung. Das Gerät verfügt über eine Metallstruktur, die in Mattweiß pulverlackiert ist und in der eine oder mehrere dimmbare Leuchtstofflampen eingesetzt sind. Das wesentliche Design ermöglicht einen Leuchteffekt, der einem Lichtschnitt auf einer Wand ähnelt.

A series of recessed lamps for walls or ceilings that give indirect light. The structure is in matt white epoxy powder-coated metal and houses one or more dimmable fluorescent lamps. Its essential design creates a luminous effect similar to a blade of light on the wall.

Serie de lámparas empotrables de pared o de techo para la iluminación con luz indirecta. El aparato presenta una estructura de metal pintada con polvo epoxi de color blanco mate que aloja una o varias lámparas fluorescentes con dimer. La esencialidad de su diseño permite obtener un efecto luminoso similar a un corte de luz sobre una pared.

Série de lampes encastrables au mur ou au plafond pour un éclairage indirect. Le luminaire présente une structure en métal laqué époxy blanc mat où sont logées une ou plusieurs lampes fluorescentes à intensité variable. Le design essentiel garantit un effet lumineux similaire à une découpe de lumière sur un mur.



LIGHTS TO LIVE / OUTDOOR

AMAX

Charles Williams, 2008

Grande lampada da esterno con diffusore in polietilene bianco traslucido, disponibile nella versione da terra (con struttura trattata per resistere alla corrosione degli agenti atmosferici) e sospesa.

Große Leuchte für den Außenbereich mit Diffusor aus durchscheinendem weißen Polyethylen, erhältlich in der Bodenausführung (mit behandelter Struktur, gegen Witterungskorrosion) und als Pendelleuchte.

Big outdoor lamp with a translucent white polyethylene diffuser, available in a floor version (with structure treated to resist corrosion by the elements) or a suspension version.

Gran lámpara de exteriores con difusor de polietileno blanco translúcido, disponible en versión de pie (con estructura tratada para resistir a la corrosión de los agentes atmosféricos) y de techo.

Luminaire d'extérieur avec diffuseur en polyéthylène blanc translucide, disponible en version lampadaire (avec une structure traitée pour résister à la corrosion des agents atmosphériques) et suspension.





AVICO

Charles Williams, 2008

Forma semisferica extra large per questa lampada sospesa da esterno con diffusore in polietilene bianco traslucido. Un disco di chiusura inferiore, che copre la vista delle sorgenti luminose, è disponibile come accessorio.

Extra-large semispherical shape for this outdoor hanging lamp with translucent white polyethylene diffuser. A lower disc that covers and hides the light sources is sold as an accessory.

Cette suspension d'extérieur à la forme semi-sphérique extra large se caractérise par un diffuseur en polyéthylène blanc translucide. Un disque de fermeture inférieur, qui cache les sources lumineuses, est disponible en option.

Extra große Halbkugelform für die Pendelleuchte für den Außenbereich mit Diffusor aus durchscheinendem weißem Polyethylen. Eine untere Verschlusscheibe, die den Blick auf die Lichtquellen verdeckt, ist als Zubehör erhältlich.

Lámpara de techo para exteriores de forma semiesférica extra large con difusor de polietileno blanco translúcido. Puede dotarse con un disco de cierre inferior opcional para ocultar las fuentes luminosas.



BOTREE

Studio Ferrara Palladino e Associati, 2008

Apparecchio luminoso da terra per esterno, presenta molteplici possibilità di configurazione per adattarsi alle specifiche esigenze illuminotecniche e di progettazione.

An outdoor floor lamp offering a multitude of configurations to suit the specific needs of lighting engineering and design.

Mât d'éclairage extérieur qui offre de multiples possibilités de configuration pour s'adapter aux exigences spécifiques en termes d'éclairage et de conception architecturale.

Beleuchtungsanordnung am Boden im Außenbereich, die viele Konfigurationsmöglichkeiten zeigt, um den spezifischen Anforderungen an Beleuchtung und Design zu entsprechen.

Aparato luminoso de pie para exteriores que presenta múltiples posibilidades de configuración para adaptarse a exigencias luminotécnicas y de diseño específicas.



CORRUBEDO

David Chipperfield, 2008

Lampada da parete per esterno con struttura in acciaio inox e diffusore in policarbonato opalino bianco. Schermo di protezione in vetro borosilicato trasparente.

Outdoor wall lamp with structure in stainless steel and diffuser in opaline white polycarbonate. Protective screen in clear borosilicate glass.

Applique extérieure avec structure en acier inox et diffuseur en polycarbonate opalin blanc. Écran de protection en verre borosilicate transparent.

Wandleuchte für den Außenbereich mit Edelstahl-Struktur und Diffusor aus Polycarbonat in Opalweiß. Schutzschirm aus transparentem Borosilikatglas.

Lámpara de pared para exteriores con estructura de acero inoxidable y difusor de policarbonato opalino blanco. Pantalla de protección de vidrio borosilicato transparente.



KODO

Metis Lighting, 1998

Semplice, essenziale, compatta.
Da parete e plafone è una lampada
adatta per essere installata all'esterno.

Simple, minimal, compact. Wall or
ceiling mounted, it can be installed
outdoors, is small in size.

Simple, essentielle, compacte. En
applique ou comme plafonnier, c'est
une lampe adaptée à l'extérieur. Elle a
des dimensions réduites.

Einfach, essentiell, kompakt. Für Wand
und Decke sowie für eine Installation
im Außenbereich geeignet hat sie
eine reduzierte Größe.

Simple, esencial, compacta. De pared
o plafón, es una lámpara que puede
instalarse en ambientes exteriores.
Tiene un tamaño reducido.



KOHO

Mika Tolvanen, 2013

Lampada ricaricabile che si sposta agevolmente senza l'ingombro di cavi e si posiziona dove è necessario avere luce. È formata da un coperchio, disponibile in tre varianti di colore, che contiene la fonte luminosa. Fino a 7 ore di autonomia.

A rechargeable lamp that can easily be moved and placed exactly where light is needed, with no cables to get in the way. It has a lid, which comes in three different colors and holds the light source. Up to 7 hours of autonomy.

Lampe rechargeable et facile à déplacer grâce à l'absence de câbles, à poser partout, chaque fois que le besoin d'éclairage se fait sentir. Elle est formée d'un couvercle, disponible en trois coloris, qui contient la source lumineuse. Jusqu'à 7 heures d'autonomie.

Wiederaufladbare Leuchte, die sich leicht ohne Kabelgewirr bewegen und dort positionieren lässt, wo Licht gebraucht wird. Sie besteht aus einer in drei Farbvarianten erhältlichen Abdeckung, in der sich die Lichtquelle befindet. Bis zu 7 Stunden Betriebsdauer.

Lámpara recargable que se desplaza cómodamente sin el estorbo de los cables para colocarla donde se necesita la luz. Está formada por una tapa disponible en tres variantes de color que contiene la fuente luminosa. Hasta 7 horas de autonomía.

- Blue
- Grey
- Yellow

Technical data pag. 420



RIGA

Paolo Zani, 2008

Lampada da parete per esterno a doppia emissione luminosa, diretta e indiretta. Schermi frontali in acciaio inox nichelato spazzolato o in ferro verniciato color alluminio anodizzato. Maschera opzionale per bloccare il flusso luminoso da un lato. Riga può essere installata in posizione orizzontale o verticale.

Wandleuchte für den Außenbereich mit doppelter Lichtausstrahlung, direkt und indirekt. Frontschirme aus Edelstahl, gebürstet und vernickelt, oder aus Eisen, lackiert, Farbe eloxiertes Aluminium. Maske als Optional, um den Lichtstrom von einer Seite her zu blockieren. Riga kann waagrecht oder senkrecht installiert werden.

An outdoor wall light with dual light emission, direct and indirect. Front screens in brushed nickel-plated stainless steel or anodized aluminum color painted iron. Optional mask for blocking the light flow on one side. Riga can be installed either horizontally or vertically.

Lámpara de pared para exteriores de doble emisión luminosa, directa e indirecta. Pantallas frontales de acero inoxidable niquelado cepillado o de hierro pintado color aluminio anodizado. Máscara opcional para bloquear el flujo luminoso por un lado. Riga puede instalarse en posición horizontal o vertical.

Applique d'extérieur à double émission lumineuse, directe et indirecte. Écrans frontaux en acier inox nickelé brossé ou en métal laqué aluminium anodisé. Ecran en option pour cacher le flux lumineux d'un côté. Riga peut être installée horizontalement ou verticalement.



UOVO

FontanaArte Design Lab, 2008

La versione da esterno di Uovo ha il diffusore in polietilene bianco opalino per resistere alle intemperie e può essere utilizzata sia come la lampada da tavolo che come lampada da appoggio a terra. Il cavo, lungo 5 metri, consente di spostarla a seconda di dove è necessario avere luce.

Die Outdoor-Version von Uovo hat einen Diffusor aus opalweißem Polyäthylen, um der Witterung zu widerstehen, und kann sowohl als Tischleuchte wie auch als Leuchte, die auf den Boden gestellt wird, verwendet werden. Das 5 m lange Kabel erlaubt das Verstellen, je nachdem, wo Licht gebraucht wird.

The outdoor version of Uovo has a diffuser in opaline white polyethylene to resist the elements and can be used either as a table lamp or placed on the floor. The 5-metre cable means it can be moved where light is required.

La versión para exteriores de Uovo posee un difusor de polietileno blanco opalino, resistente a la intemperie. Puede utilizarse como lámpara de sobremesa o como lámpara de pie. El cable, de 5 m de longitud, permite desplazarla al lugar donde se necesita la luz.

La version d'extérieur d'Uovo présente un diffuseur en polyéthylène blanc opalin pour résister aux intempéries et peut être utilisée comme lampe de table ou comme lampadaire. Le câble, de 5 mètres de long, permet de la déplacer en fonction des besoins d'éclairage.





VITRO

Emmanuel Babled, 2014

Realizzata in polimero plastico, Vitro riproduce la trasparenza e la lucentezza del cristallo molato ma, contrariamente a quest'ultimo, possiede elevatissimi requisiti di robustezza e comfort. Si monta a parete, plafone e anche incassata.

Aus Polymer hergestellt, reproduziert Vitro die Transparenz und Brillanz geschliffenen Kristalls, besitzt aber, im Gegensatz zu letzterem, sehr hohe Anforderungen an Robustheit und Komfort. Sie im wird an der Wand, der Decke und auch halb eingebaut montiert.

In plastic polymer, Vitro reproduces the transparency and brilliance of cut glass but, unlike the latter, it has very high requisites of sturdiness and comfort. It can be installed on walls, ceilings or even as recessed lighting.

Realizada en polímero plástico, Vitro reproduce la transparencia y el brillo del vidrio desbastado pero, a diferencia de este último, garantiza elevadísimos niveles de robustez y confort. Se monta en la pared, como plafón y empotrada.

Réalisée en polymère plastique, Vitro reproduit la transparence et la brillance du cristal meulé mais possède, contrairement à ce dernier, d'excellentes qualités de robustesse et de confort. Peut être fixée au mur ou au plafond ou bien encastrée.



HOME TO LIVE

CARTOCCIO, CARTOCCIO Q

Pietro Chiesa, 1932

Straordinari vasi progettati da Pietro Chiesa nel 1932 e ricavati dalla piegatura a caldo di una lastra di vetro. Cartoccio è disponibile in vetro naturale o satinato (bianco e blu) oppure stampato. La lavorazione manuale rende ogni vaso un pezzo unico.

Extraordinary vases designed by Pietro Chiesa in 1932, made from hot folding of a sheet of glass. Cartoccio is available in natural or frosted glass (white and blue) or printed. Manual production makes each one unique.

Vases extraordinaires dessinés par Pietro Chiesa en 1932 et réalisés par pliage à chaud d'une plaque de verre. Cartoccio est disponible en verre naturel ou satiné (blanc et bleu) ou moulé. La fabrication manuelle fait de chaque vase une pièce unique.

Außergewöhnliche Vasen, die 1932 von Pietro Chiesa entworfen und aus der Warmbiegung einer Glasplatte erhalten wurden. Cartoccio ist aus Naturglas oder Milchglas (weiß und blau) oder Pressglas erhältlich. Die Handarbeit macht jede Vase zu einem einzigartigen Stück.

Extraordinarios jarrones diseñados por Pietro Chiesa en 1932 y obtenidos plegando una placa de vidrio en caliente. Cartoccio está disponible en vidrio natural o satinado (blanco y azul) o grabado. Se realiza a mano, por lo que cada jarrón es una pieza única.

- Blue
- Trasparent
- White

Technical data pag. 462





FONTANA

Pietro Chiesa, 1932

Firmato da Pietro Chiesa, rappresenta per l'epoca un pezzo straordinario per essenzialità e eleganza. È un tavolino ricavato dalla doppia curvatura di una unica lastra di grosso spessore (15 mm). Disponibile in 4 dimensioni.

Von Pietro Chiesa entworfen, stellt er wegen seiner Einfachheit und Eleganz für seine Zeit (1932) ein außergewöhnliches Stück dar. Es ist ein Couchtisch, der aus der Doppelbiegung einer einzigen Glasplatte mit großer Dicke (15 mm) hergestellt wurde. Erhältlich in 4 Größen.

Designed by Pietro Chiesa, it was an extraordinary piece of essentiality and elegance. This coffee table is made from a double curved single piece of thick glass (15 mm). Available in 4 sizes.

Firmada por Pietro Chiesa, representa una pieza extraordinaria para su época (1932) por su elegancia y esencialidad. Es una mesita obtenida mediante la doble curvatura de una única placa de gran espesor (15 mm). Disponible en 4 dimensiones.

Cette table signée Pietro Chiesa constitue une pièce extraordinaire par son design essentiel et son élégance. C'est une table basse obtenue par double bombage d'une plaque de verre unique de forte épaisseur (15 mm). Disponible en 4 dimensions.



TAVOLINO 1932

Gio Ponti, 1932

Questo tavolino , che porta la firma di Gio Ponti, è composto da due dischi in vetro float dello spessore di 15 mm. La struttura è in ottone nichelato e spazzolato.

Dieser kleine Tisch, der die Handschrift von Gio Ponti trägt, besteht aus zwei Floatglas-Scheiben mit 15 mm Dicke. Die Struktur ist aus vernickeltem und gebürstetem Messing.

This coffee table was designed by Gio Ponti and is made from two discs in float glass, 15 mm thick. The structure is in brushed nickel-plated brass.

Esta mesita, que lleva la firma de Gio Ponti, está compuesta por dos discos de vidrio flotado de 15 mm de espesor. La estructura es de latón niquelado y cepillado.

Cette table basse, signée Gio Ponti, se compose de deux disques en verre flotté de 15 mm d'épaisseur. La structure est en laiton nickelé et brossé.



TAVOLO CON RUOTE

Gae Aulenti, 1980

Un carrello industriale utilizzato nella sede di FontanaArte per il trasporto di vetri: è questo l'oggetto che ha ispirato Gae Aulenti nella progettazione di Tavolo con Ruote. Tavolino icona esempio di una progettualità intuitiva nata dall'associazione con strumenti di uso quotidiano e tradotta in prototipo senza passare per il disegno.

Ein Förderwagen, der im FontanaArte-Firmensitz für den Transport von Glas verwendet wird: Das ist der Gegenstand, der Gae Aulenti bei der Gestaltung des *Tavolo con Ruote* inspirierte. Ein ikonischer Couchtisch, Beispiel einer intuitiven Projektgestaltung, die aus der Assoziation mit alltäglichen Gebrauchsgegenständen entstand und ohne Umweg über die Zeichnung in einen Prototyp übersetzt wurde.

An industrial trolley used at the FontanaArte plant to transport glass: this was the object that inspired Gae Aulenti to design her *Tavolo con Ruote*. This icon low table is a specimen of intuitive design that skips the drawing board stage and goes straight from the idea of an everyday item to the prototype stage.

Un carro industrial utilizado en la sede de FontanaArte para transportar los vidrios: este es el objeto que ha inspirado a Gae Aulenti en el diseño de *Tavolo con Ruote*. Una mesita icono, ejemplo de un proyecto intuitivo nacido de la asociación con instrumentos de uso cotidiano, traducida en prototipo sin pasar por el diseño.

Un chariot industriel utilisé dans l'usine FontanaArte pour le transport des plaques de verre : c'est cet objet qui a inspiré Gae Aulenti dans la conception du *Tavolo con Ruote*. Table basse icône exemple de l'intuition créative née de l'association avec des objets d'usage quotidien et traduite en prototype sans passer par le dessin.



TESO COLLECTION

Renzo Piano, 1985 - 1991

Renzo Piano si misura per la prima volta con il campo del design progettando per FontanaArte una produzione coordinata di sistemi d'arredo in un unico materiale: il vetro, simbolo della storia produttiva dell'azienda. Una collezione di grandissimo pregio, composta da tavolo, libreria e consolle.

Renzo Piano misst sich zum ersten Mal mit dem Bereich des Designs und entwirft für FontanaArte eine koordinierte Produktion von Einrichtungssystemen aus einem einzigartigen Material: dem Glas, Symbol der Produktionsgeschichte des Unternehmens. Eine Kollektion von größtem Wert, die aus einem Tisch, einem Bücherregal und einem Konsolentisch besteht.

Renzo Piano made his design debut with a coordinated line of furnishing systems for FontanaArte, using only one material: glass, symbol of the company's production history. A very fine collection that comprises table, bookcase and console.

Renzo Piano se mide por primera vez con el campo del diseño proyectando para FontanaArte una producción coordinada de sistemas de decoración en un único material: el vidrio, símbolo de la historia productiva de la empresa. Una colección de enorme valor, compuesta por mesa, librería y consola.

Renzo Piano se mesure pour la première fois au monde du design en dessinant pour FontanaArte une production coordonnée de systèmes d'ameublement réalisés dans un seul matériau: le verre, symbole de l'histoire de la production de l'entreprise. Une collection de très grande valeur, composée d'une table, d'une bibliothèque et d'une console.

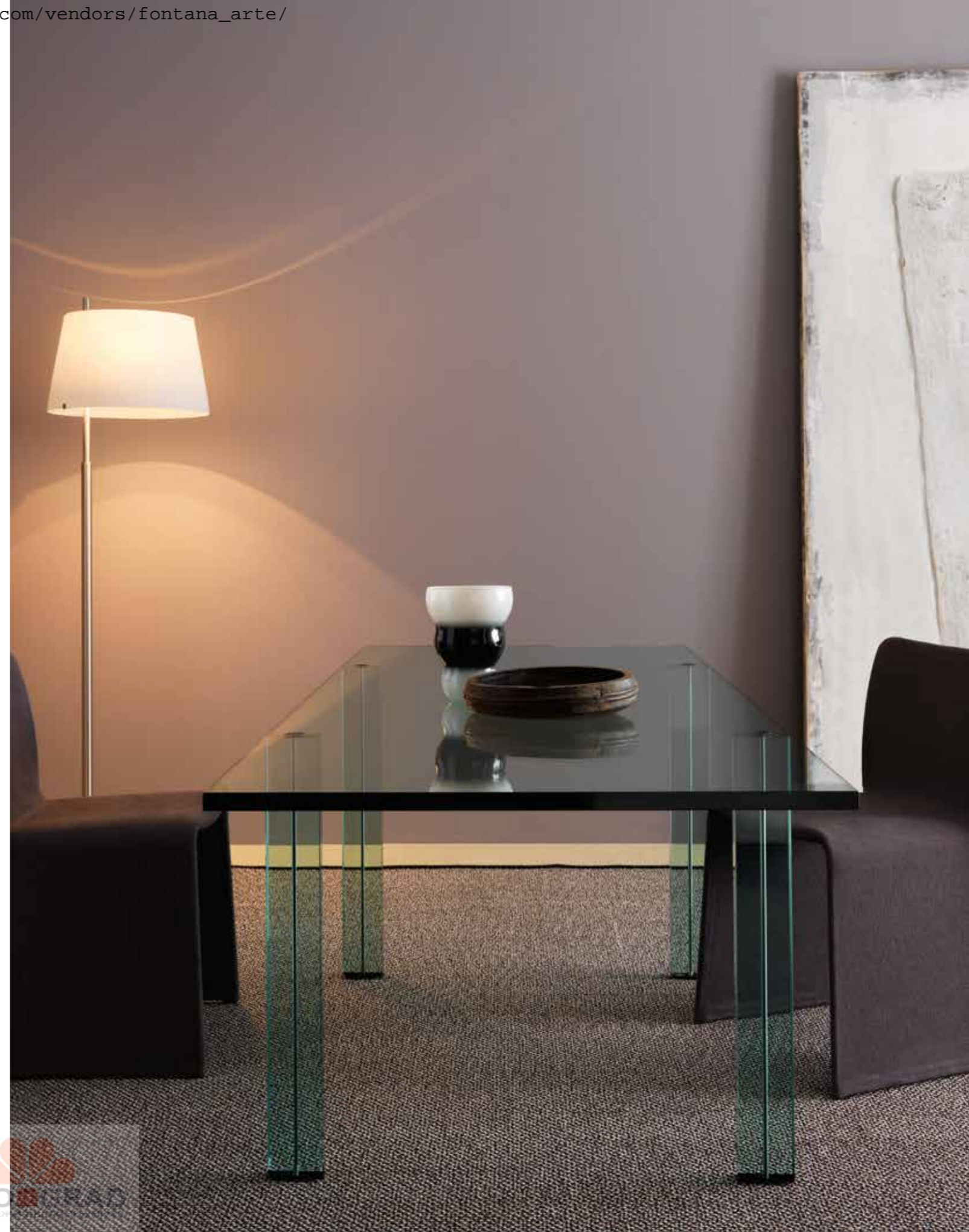



TOUR

Gae Aulenti, 1993

Tour rappresenta la declinazione successiva del Tavolo con Ruote. Dotato anch'esso di ruote, in questo caso di bicicletta, è un pezzo sorprendente. Il piano in vetro float molato, dello spessore di 15 mm, poggia su 4 ruote pivotanti mediante quattro piattelli in acciaio inox. Le forcelle sono cromate e le ruote sono rivestite di gomma.

Tour stellt die spätere Ableitung des Tavolo con Ruote dar. Ebenfalls mit Rädern, in diesem Fall von einem Fahrrad, ausgestattet, ist es ein Teil, das überrascht. Die Tischplatte besteht aus geschliffenem, 15 mm starkem Float-Glas und liegt durch vier Edelstahl-Scheiben auf 4 Pivot-Rädern auf. Die Gabeln sind verchromt und die Räder mit Gummi bezogen.

Tour is the evolution of the Table with Wheels. Again with wheels, but in this case taken from bicycles, it was a surprising piece. The beveled float glass top, 15 mm thick, rests on 4 pivoting wheels attached to four stainless steel plates. The forks are chromed and the wheels are covered in rubber.

Tour representa una variante posterior de la mesa Tavolo con Ruote. Dotada también de dos ruedas, en este caso de bicicleta, es una pieza realmente sorprendente. El sobre de vidrio flotado desbastado de 15 mm de espesor apoya sobre 4 ruedas pivotantes mediante cuatro platillos de acero inoxidable. Las horquillas son cromadas y las ruedas están recubiertas con goma.

Tour représente une déclinaison de la Tavolo con ruote. Cette pièce surprenante est également munie de roues, mais qui proviennent cette fois du monde du vélo. Le plateau en verre flotté biseauté, de 15 mm d'épaisseur, est posé sur 4 roues pivotantes fixées au moyen de quatre supports en acier inox. Les fourches sont chromées et les roues revêtues de caoutchouc.

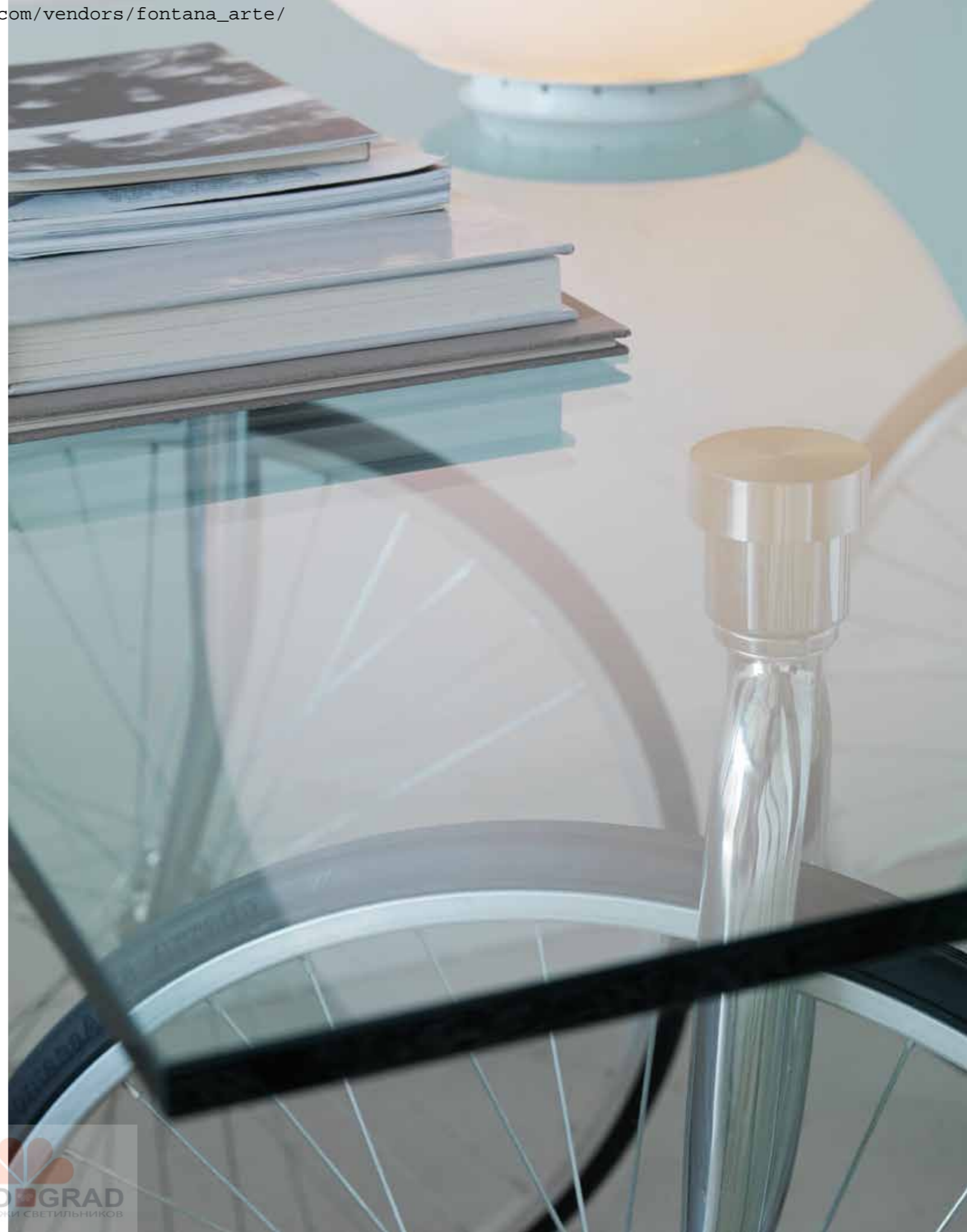



TECHNICAL DATA

sorgenti luminose / lighting sources / sources lumineuses / Lichtquellen / fuentes de luz

simboli / symbol / symboles / Symbole / símbolos

[IN] INCANDESCENTI INCANDESCENT INCANDESCENTES GLÜHLAMPEN INCANDESCENTES	[FL] FLUORESCENTI FLUORESCENT FLUORESCENTES LEUCHTSTOFFLAMPEN FLUORESCENTES	[HA] ALOGENE HALOGEN HALOGÈNES HALOGENLAMPEN HALÓGENAS	[MH] IODURI METALLICI METAL HALIDE IODURES METALLIQUES METALLDAMPFLAMPEN YODUROS METÁLICOS	[LED]
E27	G23	E14	E27	LED
E14	G24d-1 / G24d-2 G24d-3 / G24q-2 G24q-3 / GX24q-3 GX24q-4	E14	RX7S - RX7S - 24	
E14	2GX10	E14	G12	
	G5 / G13 / W4,3	E27	GX8.5	
	E14 / E27	E27	G8.5	
	E27	G9	GX10	
	2GX11	G53 AR111	PGJ5	
	G10Q	R7s / 80	GU6,5	
	GX53	R7s / 115	E 27 PAR30	
	E27	GY6.35 - GU4		
	E27	GU5.3 - GX5.3		
	E27	GU10 - GZ10		
	E27	E27 PAR20 - PAR30		
	E27	E14 PAR16		
		Eco Saver		

A++	A+	A	B	C	D	E
CLASSI DI EFFICIENZA ENERGETICA						
Le classi di efficienza energetica degli apparecchi luminosi, definite dal reg. UE n.874/2012, spaziano in un intervallo compreso tra A++ (efficienza massima) ed E (efficienza minima).						
ENERGY EFFICIENCY CLASSES						
Energy efficiency classes for lights, as defined by European Commission delegated regulation no. EU 874/2012, range from A++ (maximum efficiency) to E (minimum efficiency).						
CLASSE D'EFFICACITÀ ENERGETICA						
Les classes d'efficacité énergétique des luminaires, définies dans le règlement UE n° 874/2012 sont comprises dans une plage qui va de A++ (efficacité maximale) à E (efficacité minimale).						
ENERGIE EFFIZIENZKLASSEN						
Die Energieeffizienzklassen von Leuchtgeräten, die von der Verordnung Nr. 874/2012/EU festgelegt werden, liegen in einem Bereich zwischen A++ (höchster Effizienz) und E (niedrigster Effizienz).						
CLASES DE EFICIENCIA ENERGÉTICA						
Las clases de eficiencia energética de los aparatos luminosos, definidas por el reglamento UE n.º 874/2012, abarcan un intervalo comprendido entre A++ (eficiencia máxima) y E (eficiencia mínima).						

	Marchatura obbligatoria che attesta la conformità del prodotto alle disposizioni delle direttive comunitarie	CE is a mandatory marking certifying the conformity of the product to the community directives	La marquage CE atteste de la conformité du produit aux dispositions des directives communautaires	Die CE-Kennzeichnung erklärt die Übereinstimmung des Produkts mit den Bestimmungen der EU-Richtlinien	El marcado CE indica la conformidad del producto con las obligaciones comunitarias
	Marchio volontario europeo che attesta la conformità del prodotto e del processo produttivo alle norme europee EN di riferimento	It certifies the compliance of a product with the EN standards and the compliance of the manufacturing process	ENEC est le gage de la conformité d'un produit aux normes EN et de la conformité du processus de fabrication	Mit diesem Prüfzeichen wird die Übereinstimmung eines Produktes und des entsprechenden Produktionsprozess mit EN-Normen zertifiziert	Marca europea que certifica la conformidad del producto con las normas EN y la conformidad del proceso de fabricación
	Istituto italiano Marchio di Qualità	Italian Institut of Quality Mark	Institut Italien de la Marque de Qualité	Italienisches Institut für Qualitätsmarktsicherung	Instituto Italiano de la Marca de Calidad
	Certifica che il prodotto è conforme e rispetta i requisiti delle normative nordamericane	Certifies that the product is conform to the North American standards	Certifie que le produit est conforme aux normes Nord-Américaines	Zertifiziert, dass das Produkt den nordamerikanischen Normen entspricht	Certifica que el producto cumple las normas norteamericanas
	Complies with Americans with Disabilities Act				
	Marchio di Certificazione Cinese	China Compulsory Certification	Marque de certification chinoise	Zertifizierung nach der chinesischen Norm	Certificado de conformidad chino
	Marchio di Certificazione Danese	Danish certification mark	Marque de certification danoise	Zertifizierung nach der dänischen Norm	Certificado de conformidad danés
	Mark of conformity for the Customs Union				
	Il grado di protezione degli apparecchi di illuminazione viene indicato con la sigla IP (International Protection) seguita da due cifre caratteristiche. La prima di queste due cifre descrive la protezione che questi possiede contro la penetrazione di corpi solidi. La seconda indica la protezione nei confronti dei liquidi	The protection rating of lighting appliances is shown by the letters IP (International Protection) followed by two characteristic digits. The first of these two digits indicates the degree of protection that the appliances offer against the ingress of solid foreign objects. The second indicates the protection against the ingress of water	Le degré de protection des appareils d'éclairage est indiqué avec le sigle IP (International Protection) suivi par deux chiffres caractéristiques. Le premier de ces deux chiffres décrit la protection que l'appareil possède contre la pénétration de corps solides. Le deuxième chiffre indique la protection vis-à-vis des liquides	Der Schutzgrad von Beleuchtungsgeräten wird mit der Abkürzung IP (International Protection) gefolgt von einer charakteristischen zweistelligen Zahl angegeben. Die erste dieser beiden Ziffern beschreibt den Schutz, den die Beleuchtungsgeräte gegen das Eindringen von Festkörpern besitzen. Die zweite Ziffer gibt den Schutz gegenüber Flüssigkeiten an	El grado de protección de los aparatos de iluminación se indica con la sigla IP (International Protection) seguida por dos dígitos de identificación característicos. La primera cifra indica el grado de protección de los aparatos contra la penetración de los cuerpos sólidos. La segunda cifra indica la protección contra los líquidos
	Apparecchio nel quale la protezione contro la scossa elettrica non si basa unicamente sull'isolamento principale, ma anche su misure supplementari di sicurezza quali il doppio isolamento o l'isolamento rinforzato. Questi apparecchi non prevedono la messa a terra	Light fittings whose safety is guaranteed only by the double and / or reinforced insulation of all parts, with no earth	Appareil où la sécurité électrique est garantie par un double niveau d'isolation de toutes les parties sans dispositif de mise à la terre	Bei Leuchten der Klasse II ist der Berührungsschutz durch eine doppelte und/oder verstärkte Schutzisolation aller spannungsführenden Teile gegeben, ohne Erdung	Aparatos con protección contra descargas eléctricas basada en un doble aislamiento o un aislamiento reforzado, sin dispositivo de toma de tierra
	Apparecchio in cui la protezione contro la folgorazione elettrica si basa sull'alimentazione a bassissima tensione e in cui non si producono tensioni superiori alla stessa (SELV)	Light fitting fitted with a protection device against electric shock that features a very low voltage power supplied and prevents it from generating higher voltages (SELV)	Appareil dans lequel la protection contre les chocs électriques se base sur l'alimentation à très basse tension de sécurité et dans lequel ne peut être généré de tension à plus haut voltage (SELV)	Diese Leuchte ist mit einer Schutzvorrichtung versehen, die einen Betrieb mit einer Schutzkleinspannung vorsieht und keine höheren Spannungen zulässt (SELV)	Aparatos en los que la protección contra descargas eléctricas se basa en un sistema de alimentación de bajo voltaje que impide que se generen voltajes superiores (SELV)
	Indice di resa cromatica	Colour rendering index	Indice de rendu de couleur	Farbwiedergabeindex	Indice de reproducción cromática
	Temperatura di colore	Colour temperature	Température de couleur	Farbtemperatur	Temperatura de color
	Halogen Eco Saver				

Alphabetical index

Tutte le dimensioni sono espresse in centimetri, se non diversamente indicato.

La tensione si intende 230V, se non diversamente indicato.

Le lampade sono generalmente fornite senza lampadina, salvo indicazione diversa specificata nel listino prezzi.

I vetri soffiati, essendo realizzati artigianalmente, possono avere spessori, colori e finiture variabili che sono da considerarsi un pregio.

FontanaArte si riserva di apportare qualsiasi modifica tecnica o formale senza preavviso, incluse modifiche per quanto concerne le sorgenti LED.

Questo catalogo sostituisce ed aggiorna i precedenti cataloghi.

All measurements are in centimeters, unless otherwise stated.

Voltage is 230V, unless otherwise stated.

The lamps are usually supplied without bulbs, unless specified otherwise on the price list.

The blown glass is artisan-produced. Thicknesses, colors and finishes may therefore vary and should be considered characteristic of the products' uniqueness.

FontanaArte reserves the right to make any technical or form changes without notice, including changes regarding the LED sources.

This catalogue replaces and updates previous catalogues.

Toutes les dimensions sont exprimées en centimètres, sauf indication contraire.

La tension est de 230 V, sauf indication contraire.

Les lampes sont généralement fournies sans ampoule, sauf indication contraire indiquée dans les tarifs.

Les verres soufflés, réalisés artisanalement, peuvent présenter des épaisseurs, des couleurs et des finitions variables qui en font des pièces uniques.

FontanaArte se réserve la faculté d'apporter sans préavis toute éventuelle modification technique ou formelle, y compris celles qui concernent les sources LED.

Ce catalogue remplace et actualise les catalogues précédents.

Alle Maße, wenn nicht anders angegeben, sind in Zentimetern ausgedrückt.

Die Spannung, wenn nicht anders angegeben, ist 230V.

Die Leuchten, wenn in der Preisliste nicht anders angegeben, werden im Allgemeinen ohne Leuchtmittel geliefert.

Da die mundgeblasenen Gläser handwerklich hergestellt sind, können sie Unterschiede in Dicke, Farbe und Finish aufweisen, was ihre Einzigartigkeit ausmacht.

FontanaArte behält sich vor, ohne Vorankündigung technische oder formale Änderungen vorzunehmen, einschließlich Veränderungen der LED-Quellen.

Dieser Katalog ersetzt und aktualisiert die vorhergehenden Kataloge.

Si no se especifica lo contrario, todas las dimensiones están indicadas en centímetros.

Si no se especifica lo contrario, la tensión es de 230 V.

Salvo especificación contraria en la tarifa, las lámparas se suministran sin bombilla.

Los vidrios sopladados están realizados artesanalmente, por lo que pueden presentar grosores, colores y acabados variables que confirman su unicidad.

FontanaArte se reserva el derecho a aportar cualquier modificación técnica o formal sin preaviso, incluso en lo que respecta a las fuentes LED.

Este catálogo reemplaza y actualiza los catálogos anteriores.

LIGHTS TO LIVE

006	370	GRAAL	411
0024	370	HUNA	411
0024XL	371	ICEBERG	412
2198	372	IGLOO	413
3247	372	IGLOO SYSTEM	415
ALBEDO	373	IO	418
AMAX	374	KIASMA	418
ANANAS	378	KINX	419
ASHANGHAI	379	KODO	519
A TOMIC	379	KOHO	420
AUREA	380	LAMPARA	420
AVICO	380	LOOP	421
BIANCA	382	LOUNGE	421
BILIA	387	LUMEN	422
BIS, TRIS	387	LUMINATOR	422
BLOM	388	LUNAIRE	423
BOLLA	388	MANO	423
BONNET	389	MARGARET	424
BOTREE	389	MARISTELLA	424
BRUCO	393	MILANO 2015	425
CHANDELIER	394	NASKA 1, 2, NASKETTA	425
CHESHIRE	395	NOBI	426
CHIARA	397	NOBI 2	430
CLOCHE	397	NOBI 4	430
CORRUBEDO	396	NUOVA SEGNO TRE	431
CUPOLA	399	ODEON	431
DARUMA	399	PANGEN	432
DRUM	401	PAROLA, PAROLONA	433
DUPLEX	401	PASSION	434
FALENA	402	PINECONE	436
FLEX	403	PIRELLINA	436
FLÔTE, FLÔTE MAGNUM	405	PIRELLONE	437
FONTANA	407	POLARIS	437
FONTANA TOTAL BLACK	408	PRIMA SIGNORA	437
GIOVA	409	PUDDING	438
GLOBO DI LUCE	409	RIGA	438

HOME TO LIVE

CARTOCCIO	462
CARTOCCIO Q	462
FONTANA	463
TAVOLINO 1932	464
TAVOLO CON RUOTE	464
TESO COLLECTION	465
TOUR	467

Lampada da parete / Wall lamp / Applique
Wandleuchte / Applique

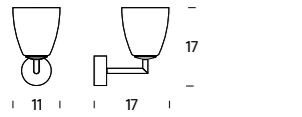

IT	EN	FR	DE	ES	
M006/1+V006BI	Lampada da parete. Montatura in metallo cromato. Diffusore in vetro soffiato satinato bianco.	Wall lamp. Chromed metal frame. White frosted blown glass diffuser.	Applique. Structure en métal chromé. Diffuseur en verre soufflé satiné blanc.	Wandleuchte. Verchromtes Metallgestell. Diffusor aus mundgeblasenem und satiniertem Glas in weiß.	Lámpara de pared. Montura de metal cromado. Difusor de vidrio soplado y satinado blanco.
M006/1	montatura	M006/1 frame	M006/1 structure	M006/1 Gestell	M006/1 montura
V006BI	diffusore	V006BI diffuser	V006BI diffuseur	V006BI Diffusor	V006BI difusor

lampadine / bulbs / ampoules / Glühbirnen / bombillas

☞ 1x60W (IN) E14 or
☞ 1x42W (HA) Ⓢ E14

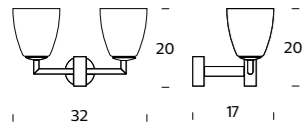

IT	EN	FR	DE	ES	
M006/2+2xV006BI	Lampada da parete a 2 luci. Montatura in metallo cromato. Diffusore in vetro soffiato satinato bianco.	Wall lamp with 2 lights. Chromed metal frame. White frosted blown glass diffuser.	Applique avec 2 ampoules. Structure en métal chromé. Diffuseur en verre soufflé satiné blanc	Wandleuchte mit 2 Leuchtmitteln. Verchromtes Metallgestell. Diffusor aus mundgeblasenem und satiniertem Glas in weiß.	Lámpara de pared con 2 luces. Montura de metal cromado. Difusor de vidrio soplado y satinado blanco.
M006/2	montatura	M006/2 frame	M006/2 structure	M006/2 Gestell	M006/2 montura
V006BI	diffusore	V006BI diffuser	V006BI diffuseur	V006BI Diffusor	V006BI difusor

lampadine / bulbs / ampoules / Glühbirnen / bombillas

☞ 2x60W (IN) E14 or
☞ 2x42W (HA) Ⓢ E14



Lampada da terra / Floor lamp / Lampadaire
Stehleuchte / Lámpara de pie

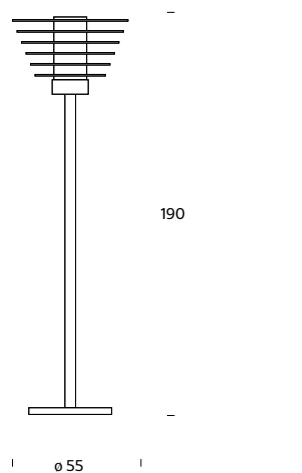

IT	EN	FR	DE	ES	
T0024VN	Lampada da terra con dimmer. Montatura in metallo cromato. Dischi in vetro temperato trasparente. Diffusore centrale in vetro termoresistente sabbiato. Cavo di alimentazione, dimmer e spina neri.	Floor lamp with dimmer. Chromed metal frame. Discs in transparent, tempered glass. Central diffuser in sandblasted, heat-resistant glass. Black power cable, dimmer and plug.	Lampadaire avec variateur. Structure en métal chromé. Disques en verre trempé transparent. Diffuseur central en verre thermorésistant sablé. Câble d'alimentation, variateur et fiche noirs.	Stehleuchte mit Dimmer. Gestell aus verchromtem Metall. Scheiben aus transparentem getempertem Glas. Zentraler Diffusor aus sandgestrahltem hitzebeständigem Glas. Netzkabel, Dimmer und Netzstecker schwarz.	Lámpara de pie con dimmer. Montura de metal cromado. Discos de vidrio templado transparente. Difusor central de vidrio termoresistente arenado. Cable de alimentación, dimmer y enchufe negros.

lampadine / bulbs / ampoules / Glühbirnen / bombillas

☞ 1x205W (HA) Ⓢ E27



Lampada a sospensione / Suspension lamp
Suspension / Pendelleuchte / Suspensión

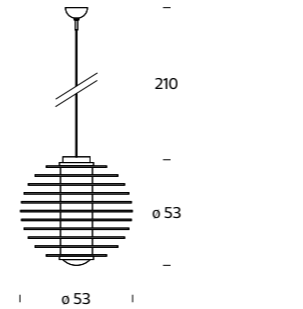

IT	EN	FR	DE	ES	
0024VN	Lampada a sospensione. Dischi in vetro temperato trasparente. Diffusore cilindrico in vetro sabbiato. Struttura in ottone cromato. Il rosone, come tutti i particolari della struttura, è cromato.	Suspension lamp. Transparent tempered glass discs. Tubular sandblasted glass diffuser. Chrome-plated brass frame. Canopy and all frame trim are chromed.	Suspension. Disques en verre trempé transparent. Diffuseur cylindrique en verre sablé. Structure en laiton chromé. Rosace, comme toutes les pièces de la structure, est chromée.	Hängeleuchte. Scheiben aus getempertem transparentem Glas. Zylindrischer Diffusor aus sandgestrahltem Glas. Struktur aus verchromten Messing. Die Rosette ist, wie alle Strukturteile, verchromt.	Lámpara de techo. Discos de vidrio templado transparente. Difusor cilíndrico de vidrio arenado. Estructura de latón cromado. Florón cromado, al igual que todos los detalles de la estructura.

lampadine / bulbs / ampoules / Glühbirnen / bombillas

☞ 2x36W (FL) 2G11 dimmable 1=10V



Lampada a sospensione / Suspension lamp
Suspension / Pendelleuchte / Suspensión

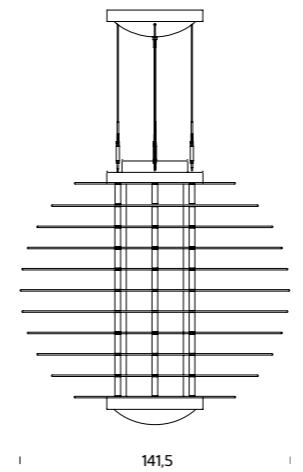

IT	EN	FR	DE	ES	
0024/3VN	Lampada a sospensione. Montatura in ottone cromato. Dischi in vetro temperato trasparente. Il diffusore centrale cilindrico in vetro sabbiato del diametro di 30 cm, ospita 4 sorgenti luminose fluorescenti tipo G5 da 54W, con alimentazione elettronica digitale DALI. Dal copri rosone partono i 4 cavi di sospensione la cui lunghezza deve essere indicata all'ordine. Il livellamento della lampada, una volta appesa, avviene tramite gli appositi tenditori posti sui cavi di sospensione. A richiesta è disponibile una versione con dischi in metacrilato e/o con luce di emergenza: in questo caso due sorgenti luminose garantiscono un'autonomia di circa un'ora senza alimentazione. In considerazione del peso della lampada (circa Kg 300 nella versione con dischi in vetro e circa Kg 200 nel caso di dischi in metacrilato) si impone una verifica preventiva sulla portata del soffitto.	Suspension lamp. Chrome-plated brass frame. Transparent tempered glass discs. The 30 cm-diameter central tubular sandblasted glass diffuser holds 4 G5 54W fluorescent light sources with DALI digital electronic power supply. The 4 suspension cables are housed in the canopy cover and the required length should be indicated at time of ordering. The lamp is levelled once mounted, using special tensioners fitted to the suspension cables. A version with methacrylate discs and/or emergency lighting is available on request. In this case, two beams of light ensure about one hour of autonomy without mains power. Ceiling strength should be verified in advance due to the weight of the lamp (about 300 Kg for glass disc version and 200 Kg for the methacrylate disc version).	Suspension. Structure en laiton chromé. Disques en verre trempé transparent. Le diffuseur central cylindrique, en verre sablé de 30 cm de diamètre, abrite 4 sources lumineuses fluorescentes G5 de 54W avec alimentation électronique numérique DALI. Quatre câbles de suspension partent du couvre-rosace, leur longueur doit être indiquée à la commande. Le réglage de la lampe, une fois suspendue, se fait à l'aide des tendeurs placés sur les câbles de suspension. Une version avec disques en méthacrylate et/ou lampe de secours est également disponible sur demande : dans ce cas, deux sources lumineuses garantissent une autonomie d'environ une heure sans alimentation. En raison du poids de la lampe (environ 300 Kg pour la version avec disques en verre et environ 200 Kg pour la version avec disques en méthacrylate), un contrôle préalable de la résistance du plafond s'impose.	Hängeleuchte. Gestell aus verchromtem Messing. Scheiben aus transparentem getempertem Glas. Der zentrale Diffusor in Zylinderform aus sandgestrahltem Glas mit Durchmesser 30 cm enthält 4 Stck. G5 Leuchtstofflampen zu 54W mit DALI EVG. Von der Rosettenabdeckung gehen 4 Aufhängekabel aus, deren Länge bei der Bestellung angegeben werden muss. Die Ausrichtung der montierten Leuchte erfolgt durch Spanner an den Aufhängekabeln. Auf Anfrage ist eine Version mit Scheiben aus Methacrylat und/oder mit Notlicht erhältlich: In diesem Fall garantieren zwei Leuchtquellen eine Autonomie von etwa einer Stunde ohne Stromversorgung. In Anbetracht des Gewichtes der Leuchte (ca. 300 Kg in der Version mit Glasscheiben und ca. 200 Kg mit Methacrylatscheiben) muss die Tragfähigkeit der Decke vorher geprüft werden.	Lámpara de techo. Montura de latón cromado. Discos de vidrio templado transparente. El difusor central cilíndrico de vidrio arenado, de 30 cm de diámetro, aloja 4 fuentes luminosas fluorescentes de tipo G5 de 54W, con alimentación electrónica digital DALI. De la tapa del florón salen los 4 cables de suspensión, cuya longitud debe indicarse en el pedido. La nivelación de la lámpara, una vez instalada, se efectúa a través de los tensores situados en los cables de suspensión. A petición, existe una versión con discos de metacrilato o con luz de emergencia: en este caso dos fuentes luminosas garantizan una autonomía de aproximadamente una hora sin alimentación. Considerando el peso de la lámpara (unos 300 Kg en la versión de discos de vidrio y unos 200 Kg cuando los discos son de metacrilato) es necesario verificar previamente la capacidad de carga del techo.

lampadine / bulbs / ampoules / Glühbirnen / bombillas

☞ 4x54W (FL) G5



2198

pag. 42

Lampada da tavolo / Table lamp / Lampe de table / Tischleuchte / Lámpara de sobremesa

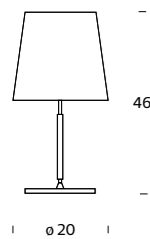

IT	EN	FR	DE	ES	
2198TA/0	Lampada da tavolo con dimmer. Diffusore in vetro soffiato bianco satinato. Stelo in legno di pero. Base in metallo verniciato color alluminio. Cavo di alimentazione, dimmer e spina neri.	Table lamp with dimmer. Frosted white blown glass diffuser. Pearwood stem. Metal base with aluminium finish. Black power cable, dimmer and plug.	Lampe de table avec variateur. Diffuseur en verre soufflé blanc satiné. Tige en bois de poirier. Base en métal peint en couleur aluminium. Câble d'alimentation, fiche et variateur noirs.	Tischleuchte mit Dimmer. Diffusor aus weißem geblasenem satiniertem Glas. Stiel aus Birnbaumholz. Socket aus Metall, aluminiumfarben lackiert. Netzkabel, Dimmer und Netzstecker schwarz.	Lámpara de sobremesa con dimmer. Difusor de vidrio soplado blanco satinado. Pie de madera de peral. Base de metal pintado color aluminio. Cable de alimentación, dimer y enchufe negros.

lampadine / bulbs / ampoules / Glühbirnen / bombillas

- 1x75W (IN) E27 or
- 1x70W (HA) E27 or
- 1x16W (FL) E27



Lampada da tavolo / Table lamp / Lampe de table / Tischleuchte / Lámpara de sobremesa

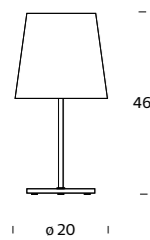

IT	EN	FR	DE	ES	
3247TA/0	Lampada da tavolo con dimmer. Diffusore in vetro soffiato bianco satinato. Montatura in metallo nichelato. Cavo di alimentazione, dimmer e interruttore neri.	Table lamp with dimmer. Diffuser in white frosted blown glass with white interior. Nickel-plated metal frame. Black power cable, dimmer and switch.	Lampe de table avec variateur. Diffuseur en verre soufflé blanc satiné opalin satiné, blanc à l'intérieur. Structure en métal nickelé. Câble d'alimentation, variateur et interrupteur noirs.	Tischleuchte mit Dimmer. Diffusor aus weißem oder rotem geblasenem satiniertem Glas. Gestell aus vernickeltem Metall. Netzkabel, Dimmer und Schalter schwarz.	Lámpara de sobremesa con dimmer. Difusor de vidrio soplado blanco satinado o rojo satinado, blanco en el interior. Montura de metal niquelado. Cable de alimentación, dimer e interruptor negros.

lampadine / bulbs / ampoules / Glühbirnen / bombillas

- 1x75W (IN) E27 or
- 1x70W (HA) E27 or
- 1x16W (FL) E27

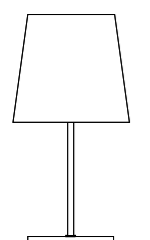

IT	EN	FR	DE	ES	
3247TA	Lampada da tavolo con dimmer. Diffusore in vetro soffiato bianco satinato. Montatura in metallo nichelato. Cavo di alimentazione, dimmer e interruttore neri.	Table lamp with dimmer. Diffuser in white frosted blown glass with white interior. Nickel-plated metal frame. Black power cable, dimmer and switch.	Lampe de table avec variateur. Diffuseur en verre soufflé blanc satiné opalin satiné, blanc à l'intérieur. Structure en métal nickelé. Câble d'alimentation, variateur et interrupteur noirs.	Tischleuchte mit Dimmer. Diffusor aus weißem oder rotem geblasenem satiniertem Glas. Gestell aus vernickeltem Metall. Netzkabel, Dimmer und Schalter schwarz.	Lámpara de sobremesa con dimmer. Difusor de vidrio soplado blanco satinado o rojo satinado, blanco en el interior. Montura de metal niquelado. Cable de alimentación, dimer e interruptor negros.

lampadine / bulbs / ampoules / Glühbirnen / bombillas

- 1x100W (HA) E27 or
- 1x20W (FL) E27



Lampada da terra / Floor lamp / Lampadaire Stehleuchte / Lámpara de pie

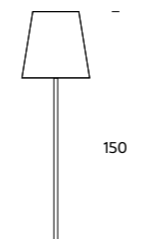

IT	EN	FR	DE	ES	
3247/1	Lampada da terra con dimmer. Montatura in metallo nichelato. Diffusore in vetro soffiato bianco. Cavo di alimentazione, dimmer e spina neri.	Floor lamp with dimmer. Nickel-plated metal frame. Diffuser in frosted white blown glass. Black power cable, dimmer and plug.	Lampadaire avec variateur. Structure en métal nickelé. Diffuseur en verre soufflé blanc satiné. Câble d'alimentation, variateur et fiche noirs.	Stehleuchte mit Dimmer. Gestell aus vernickeltem Metall. Diffusor aus weißem oder rotem mundgeblasenem satiniertem Glas. Netzkabel, Dimmer und Netzstecker schwarz.	Lámpara de pie con dimmer. Montura de metal niquelado. Difusor de vidrio soplado blanco satinado. Cable de alimentación, dimer y enchufe negros.

lampadine / bulbs / ampoules / Glühbirnen / bombillas

- 1x150W (HA) E27 or
- 1x20W (FL) E27

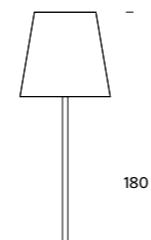

IT	EN	FR	DE	ES	
3247	Lampada da terra con dimmer. Montatura in metallo nichelato. Diffusore in vetro soffiato bianco. Cavo di alimentazione, dimmer e spina neri.	Floor lamp with dimmer. Nickel-plated metal frame. Diffuser in frosted white blown glass. Black power cable, dimmer and plug.	Lampadaire avec variateur. Structure en verre soufflé blanc satiné. Câble d'alimentation, variateur et fiche noirs.	Stehleuchte mit Dimmer. Gestell aus vernickeltem Metall. Diffusor aus weißem oder rotem mundgeblasenem satiniertem Glas. Netzkabel, Dimmer und Netzstecker schwarz.	Lámpara de pie con dimmer. Montura de metal niquelado. Difusor de vidrio soplado blanco satinado. Cable de alimentación, dimer y enchufe negros.

lampadine / bulbs / ampoules / Glühbirnen / bombillas

- 4x60W (IN) E27 or
- 4x20W (FL) E27 +
- 1x100W (HA) E27



ALBEDO

pag. 48

Lampada a sospensione / Suspension lamp Suspension / Pendelleuchte / Suspensión

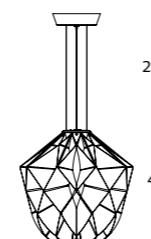

IT	EN	FR	DE	ES	
4547BI	Sospensione. Diffusore in tessuto colore bianco, lavabile in lavatrice. Struttura in metallo. Emissione di luce diffondente. Cavi di sospensione in acciaio. Cavo di alimentazione trasparente. Rosone bianco.	Suspension lamp. Diffuser in white fabric, machine washable. Metal structure. Diffused light emission. Steel suspension cables. Clear power cable. White canopy.	Suspension. Diffuseur en tissu de couleur blanche, lavable en machine. Structure en métallique. Émission de lumière diffuse. Câbles de suspension en acier. Câble d'alimentation transparent. Rosace blanche.	Pendelleuchte. Diffusor aus weißem Stoff, maschinenwaschbar. Metallstruktur. Diffuse Beleuchtung. Stahlseil zum Aufhängen. Transparentes Netzkabel. Weißer Deckenbaldachin.	Lámpara de techo. Difusor de tejido color blanco, lavable en lavadora. Estructura de metal. Emisión de luz difusa. Cables de suspensión de acero. Cable de alimentación transparente. Rosetón blanco.

lampadine / bulbs / ampoules / Glühbirnen / bombillas

- 1x33W (FL) E27 or
- 1x20W (FL dimmable) E27



	IT	EN	FR	DE	ES	
	4547/1BI	Sospensione. Diffusore in tessuto colore bianco, lavabile in lavatrice. Struttura in metallo. Emissione di luce diffusa. Cavi di sospensione in acciaio. Cavo di alimentazione trasparente. Rosone bianco.	Suspension lamp. Diffuser in white fabric, machine washable. Metal structure. Diffused light emission. Steel suspension cables. Clear power cable. White canopy. Rosace blanche.	Suspension. Diffuseur en tissu de couleur blanche, lavable en machine. Structure en métallique. Émission de lumière diffuse. Câbles de suspension en acier. Câble d'alimentation transparent. Rosace blanche.	Pendelleuchte. Diffusor aus weißem Stoff, maschinenwaschbar. Metallstruktur. Diffuse Beleuchtung. Stahlseil zum Aufhängen. Transparentes Netzkabel. Weißer Deckenbaldachin.	Lámpara de techo. Difusor de tejido color blanco, lavable en lavadora. Estructura de metal. Emisión de luz difusa. Cables de suspensión de acero. Cable de alimentación transparente. Rosetón blanco.
	<p>lampadine / bulbs / ampoules / Glühbirnen / bombillas</p> <p> 1x33W (FL) E27 or 1x20W (FL dimmable) E27 </p> <p> IP20 </p>					

	IT	EN	FR	DE	ES	
	4547/2BI	Sospensione. Diffusore in tessuto colore bianco, lavabile in lavatrice. Struttura in metallo. Emissione di luce diffusa. Cavi di sospensione in acciaio. Cavo di alimentazione trasparente. Rosone bianco.	Suspension lamp. Diffuser in white fabric, machine washable. Metal structure. Diffused light emission. Steel suspension cables. Clear power cable. White canopy. Rosace blanche.	Suspension. Diffuseur en tissu de couleur blanche, lavable en machine. Structure en métallique. Émission de lumière diffuse. Câbles de suspension en acier. Câble d'alimentation transparent. Rosace blanche.	Pendelleuchte. Diffusor aus weißem Stoff, maschinenwaschbar. Metallstruktur. Diffuse Beleuchtung. Stahlseil zum Aufhängen. Transparentes Netzkabel. Weißer Deckenbaldachin.	Lámpara de techo. Difusor de tejido color blanco, lavable en lavadora. Estructura de metal. Emisión de luz difusa. Cables de suspensión de acero. Cable de alimentación transparente. Rosetón blanco.
	<p>lampadine / bulbs / ampoules / Glühbirnen / bombillas</p> <p> 3x33W (FL) E27 or 3x20W (FL dimmable) E27 </p> <p> IP20 </p>					

AMAX

pag. 52 (outdoor pag. 322)

Lampada da terra / Floor lamp / Lampadaire Stehleuchte / Lámpara de pie

	IT	EN	FR	DE	ES	
	5586/OBI	Lampada da terra con dimmer. Montatura in metallo cromato. Diffusore in polietilene colore bianco. Cavo di alimentazione, dimmer e spina trasparenti.	Floor lamp with dimmer. Chromed metal frame. White polyethylene diffuser. Transparent power cable, dimmer and plug.	Lampadaire avec variateur. Structure en métal chromé. Diffuseur en polyéthylène de couleur blanche. Câble d'alimentation, variateur et fiche transparents.	Stehlampe mit Dimmer. Gestell aus verchromtem Metall. Diffusor aus weißem Polyäthylen. Netzkabel, Dimmer und Netzstecker transparent.	Lámpara de pie con dimmer. Montura de metal cromado. Difusor de polietileno blanco. Cable de alimentación, dimer y enchufe transparentes.
	<p>lampadine / bulbs / ampoules / Glühbirnen / bombillas</p> <p> 3x100W (HA) E27 or 3x20W (FL) E27 </p> <p> IP20 </p>					

	IT	EN	FR	DE	ES	
	5586BI	Lampada da terra con dimmer. Montatura in metallo cromato. Diffusore in polietilene colore bianco. Cavo di alimentazione, dimmer e spina trasparenti.	Floor lamp with dimmer. Chromed metal frame. White polyethylene diffuser. Transparent power cable, dimmer and plug.	Lampadaire avec variateur. Structure en métal chromé. Diffuseur en polyéthylène de couleur blanche. Câble d'alimentation, variateur et fiche transparents.	Stehleuchte mit Dimmer. Gestell aus verchromtem Metall. Diffusor aus weißem Polyäthylen. Netzkabel, Dimmer und Netzstecker transparent.	Lámpara de pie con dimmer. Montura de metal cromado. Difusor de polietileno blanco. Cable de alimentación, dimer y enchufe transparentes.
	<p>lampadine / bulbs / ampoules / Glühbirnen / bombillas</p> <p> 3x150W (HA) E27 or 3x30W (FL) E27 </p> <p> IP20 </p>					

Lampada a sospensione / Suspension lamp Suspension / Pendelleuchte / Suspensión

	IT	EN	FR	DE	ES	
	5444/000...	Lampada a sospensione. Montatura in metallo cromato. Diffusore in polietilene bianco all'interno e disponibile all'esterno nei colori bianco BI e nero N/BI (RAL 9005 opaco). Cavo di sospensione in acciaio. Cavo di alimentazione trasparente eccetto per la versione BI dove il cavo è colorato rosso. Amax è disponibile su richiesta anche con diffusore grigio metallizzato MS/BI oppure dorato OO/BI.	Suspension lamp. Chromed metal frame. Polyethylene diffuser with white interior; exterior available in white BI or black N/BI (RAL 9005 matt). Steel suspension cable. Transparent power cable, red color for the BI version. Available on request with metallic grey MS/BI or gold OO/BI diffuser.	Suspension. Structure en métal chromé. Diffuseur en polyéthylène blanc à l'intérieur et disponible à l'extérieur dans les couleurs blanc BI et noir N/BI (RAL 9005 mate). Câble de suspension en acier. Câble d'alimentation transparent, pour la version blanche BI, le câble d'alimentation est rouge. Amax est également disponible sur demande avec diffuseur gris métallisé MS/BI ou doré OO/BI.	Hängeleuchte. Gestell aus verchromtem Metall. Diffusor aus Polyäthylen innen weiß und außen in den Farben weiß BI und schwarz N/BI (RAL 9005 matt) erhältlich. Aufhängekabel aus Stahl. Transparentes Netzkabel, bei der Version BI ist das Netzkabel rot. Auf Anfrage ist Amax auch mit einem Diffusor grau metallisch MS/BI oder goldfarben OO/BI erhältlich.	Lámpara de techo. Montura de metal cromado. Difusor de polietileno blanco en el interior y disponible externamente en los colores blanco BI y negro N/BI (RAL 9005 mate). Cable de suspensión de acero. Cable de alimentación transparente, para la versión BI el cable de alimentación es rojo. Amax está disponible con difusor gris metalizado MS/BI o dorado OO/BI.
	<p>lampadine / bulbs / ampoules / Glühbirnen / bombillas</p> <p> 1x100W (HA) E27 or 1x20W (FL) E27 </p> <p> IP20 </p>					

	IT	EN	FR	DE	ES	
	5444/00...	Lampada a sospensione. Montatura in metallo cromato. Diffusore in polietilene bianco all'interno e disponibile all'esterno nei colori bianco BI e nero N/BI (RAL 9005 opaco). Cavo di sospensione in acciaio. Cavo di alimentazione trasparente eccetto per la versione BI dove il cavo è colorato rosso. Amax è disponibile su richiesta anche con diffusore grigio metallizzato MS/BI oppure dorato OO/BI.	Suspension lamp. Chromed metal frame. Polyethylene diffuser with white interior; exterior available in white BI or black N/BI (RAL 9005 matt). Steel suspension cable. Transparent power cable, red color for the BI version. Available on request with metallic grey MS/BI or gold OO/BI diffuser.	Suspension. Structure en métal chromé. Diffuseur en polyéthylène blanc à l'intérieur et disponible à l'extérieur dans les couleurs blanc BI et noir N/BI (RAL 9005 mate). Câble de suspension en acier. Câble d'alimentation transparent, pour la version blanche BI, le câble d'alimentation est rouge. Amax est également disponible sur demande avec diffuseur gris métallisé MS/BI ou doré OO/BI.	Hängeleuchte. Gestell aus verchromtem Metall. Diffusor aus Polyäthylen innen weiß und außen in den Farben weiß BI und schwarz N/BI (RAL 9005 matt) erhältlich. Aufhängekabel aus Stahl. Transparentes Netzkabel, bei der Version BI ist das Netzkabel rot. Auf Anfrage ist Amax auch mit einem Diffusor grau metallisch MS/BI oder goldfarben OO/BI erhältlich.	Lámpara de techo. Montura de metal cromado. Difusor de polietileno blanco en el interior y disponible externamente en los colores blanco BI y negro N/BI (RAL 9005 mate). Cable de suspensión de acero. Cable de alimentación transparente, para la versión BI el cable de alimentación es rojo. Amax está disponible con difusor gris metalizado MS/BI o dorado OO/BI.
	<p>lampadine / bulbs / ampoules / Glühbirnen / bombillas</p> <p> 1x150W (HA) E27 or 1x20W (FL) E27 </p> <p> IP20 </p>					

	IT	EN	FR	DE	ES	
	5444/O...	Lampada a sospensione. Montatura in metallo cromato. Diffusore in polietilene bianco all'interno e disponibile all'esterno nei colori bianco BI e nero N/BI (RAL 9005 opaco). Cavo di sospensione in acciaio. Cavo di alimentazione trasparente eccetto per la versione BI dove il cavo è colorato rosso. Amax è disponibile su richiesta anche con diffusore grigio metallizzato MS/BI oppure dorato OO/BI .	Suspension lamp. Chromed metal frame. Polyethylene diffuser with white interior; exterior available in white BI or black N/BI (RAL 9005 matt). Steel suspension cable. Transparent power cable, red color for the BI version. Available on request with metallic grey MS/BI or gold OO/BI diffuser.	Suspension. Structure en métal chromé. Diffusor en polyéthylène blanc à l'intérieur et disponible à l'extérieur dans les couleurs blanc BI et noir N/BI (RAL 9005 mate). Câble de suspension en acier. Câble d'alimentation transparent, pour la version blanche BI, le câble d'alimentation est rouge. Amax est également disponible sur demande avec diffuseur gris métallisé MS/BI ou doré OO/BI .	Hängeleuchte. Gestell aus verchromtem Metall. Diffusor aus Polyäthylen innen weiß und außen in den Farben weiß BI und schwarz N/BI (RAL 9005 matt) erhältlich. Aufhängekabel aus Stahl. Transparentes Netzkabel, bei der Version BI ist das Netzkabel rot. Auf Anfrage ist Amax auch mit einem Diffusor grau metallisch MS/BI oder goldfarben OO/BI erhältlich.	Lámpara de techo. Montura de metal cromado. Difusor de polietileno blanco en el interior y disponible externamente en los colores blanco BI y negro N/BI (RAL 9005 mate). Cable de suspensión de acero. Cable de alimentación transparente, para la versión BI el cable de alimentación es rojo. Amax está disponible con difusor gris metalizado MS/BI o dorado OO/BI .

lampadine / bulbs / ampoules / Glühbirnen / bombillas

3x100W (HA) E27 or
 3x20W (FL) E27

IP20

	5562/00	Su questo modello è possibile montare un disco di chiusura opzionale in metacrilato con tige telescopica e tappo di ancoraggio.	This model fits an optional methacrylate cover with telescopic stem and securing plug.	Ce modèle peut être équipé avec un disque optionnel de fermeture en méthacrylate avec tige télescopique et bouchon d'ancrage.	Dieses Modelle kann mit einer Abschlusscheibe aus Methacrylat mit ausziehbarer Stange und Schließkappe geliefert werden.	Este modelo se puede equipar con un disco de cierre opcional en metacrilato con barra telescópica y anclaje.
--	----------------	---------------------------------------------------------------------------------------------------------------------------------	----------------------------------------------------------------------------------------	-------------------------------------------------------------------------------------------------------------------------------	--------------------------------------------------------------------------------------------------------------------------	--------------------------------------------------------------------------------------------------------------

	5444...	Lampada a sospensione. Montatura in metallo cromato. Diffusore in polietilene bianco all'interno e disponibile all'esterno nei colori bianco BI e nero N/BI (RAL 9005 opaco). Cavo di sospensione in acciaio. Cavo di alimentazione trasparente eccetto per la versione BI dove il cavo è colorato rosso. Amax è disponibile su richiesta anche con diffusore grigio metallizzato MS/BI oppure dorato OO/BI .	Suspension lamp. Chromed metal frame. Polyethylene diffuser with white interior; exterior available in white BI or black N/BI (RAL 9005 matt). Steel suspension cable. Transparent power cable, red color for the BI version. Available on request with metallic grey MS/BI or gold OO/BI diffuser.	Suspension. Structure en métal chromé. Diffusor en polyéthylène blanc à l'intérieur et disponible à l'extérieur dans les couleurs blanc BI et noir N/BI (RAL 9005 mate). Câble de suspension en acier. Câble d'alimentation transparent, pour la version blanche BI, le câble d'alimentation est rouge. Amax est également disponible sur demande avec diffuseur gris métallisé MS/BI ou doré OO/BI .	Hängeleuchte. Gestell aus verchromtem Metall. Diffusor aus Polyäthylen innen weiß und außen in den Farben weiß BI und schwarz N/BI (RAL 9005 matt) erhältlich. Aufhängekabel aus Stahl. Transparentes Netzkabel, bei der Version BI ist das Netzkabel rot. Auf Anfrage ist Amax auch mit einem Diffusor grau metallisch MS/BI oder goldfarben OO/BI erhältlich.	Lámpara de techo. Montura de metal cromado. Difusor de polietileno blanco en el interior y disponible externamente en los colores blanco BI y negro N/BI (RAL 9005 mate). Cable de suspensión de acero. Cable de alimentación transparente, para la versión BI el cable de alimentación es rojo. Amax está disponible con difusor gris metalizado MS/BI o dorado OO/BI .
--	----------------	-------------------------------------------------------------------------------------------------------------------------------------------------------------------------------------------------------------------------------------------------------------------------------------------------------------------------------------------------------------------------------------------------------------------------------------------	---------------------------------------------------------------------------------------------------------------------------------------------------------------------------------------------------------------------------------------------------------------------------------------------------------------------------------	-----------------------------------------------------------------------------------------------------------------------------------------------------------------------------------------------------------------------------------------------------------------------------------------------------------------------------------------------------------------------------------------------------------------------------------	---------------------------------------------------------------------------------------------------------------------------------------------------------------------------------------------------------------------------------------------------------------------------------------------------------------------------------------------------------------------------------------------	------------------------------------------------------------------------------------------------------------------------------------------------------------------------------------------------------------------------------------------------------------------------------------------------------------------------------------------------------------------------------------------------------

lampadine / bulbs / ampoules / Glühbirnen / bombillas

3x150W (HA) E27 or
 3x20W (FL) E27

IP20

	5443...	lampadine / bulbs / ampoules / Glühbirnen / bombillas	3x42W (FL) Gx24q-4 dimmable 1÷10V	IP20
--	----------------	-------------------------------------------------------	-----------------------------------	------

	5562	Su questo modello è possibile montare un disco di chiusura opzionale in metacrilato con tige telescopica e tappo di ancoraggio.	This model fits an optional methacrylate cover with telescopic stem and securing plug.	Ce modèle peut être équipé avec un disque optionnel de fermeture en méthacrylate avec tige télescopique et bouchon d'ancrage.	Dieses Modelle kann mit einer Abschlusscheibe aus Methacrylat mit ausziehbarer Stange und Schließkappe geliefert werden.	Este modelo se puede equipar con un disco de cierre opcional en metacrilato con barra telescópica y anclaje.
--	-------------	---------------------------------------------------------------------------------------------------------------------------------	----------------------------------------------------------------------------------------	-------------------------------------------------------------------------------------------------------------------------------	--------------------------------------------------------------------------------------------------------------------------	--------------------------------------------------------------------------------------------------------------

	5587/OBI	Lampada da terra per esterno. Base in ferro e struttura in alluminio, protette con trattamento di cataforesi e verniciate grigio opaco (RAL 9006). Diffusore in polietilene bianco traslucido. La lampada è fornita con 5 metri di cavo cablato e spina in classe di protezione IPX4.	Outdoor floor lamp with iron base and aluminium frame, with cathaphoresis protective coating and matte grey (RAL 9006) finish. Translucent white polyethylene diffuser. The lamp comes with 5 metres of wired cable and IPX4 protection class plug.	Lampadaire d'extérieur. Base en fer et structure en aluminium, traitées en cathaphorèse et peintes en gris mat (RAL 9006). Diffusor en polyéthylène blanc translucide. La lampe est fournie avec 5 mètres de câble équipé de fiche en classe de protection IPX4.	Stehleuchte für den Außenbereich. Basis aus Eisen, Struktur aus Aluminium, durch Kataphorese witterungsgeschützt und mattgrau lackiert (RAL 9006). Diffusor aus weißem durchscheinendem Polyäthylen. Die Leuchte wird mit 5 Meter Kabel und einem Netzstecker der Schutzart IPX4 geliefert.	Lámpara de pie para exteriores. Base de hierro y estructura de aluminio, protegidas con tratamiento de cataforesis y pintadas en gris mate (RAL 9006). Difusor de polietileno blanco translúcido. La lámpara incluye 5 metros de cable con conectores y enchufe con clase de protección IPX4.
--	-----------------	---------------------------------------------------------------------------------------------------------------------------------------------------------------------------------------------------------------------------------------------------------------------------------------	-----------------------------------------------------------------------------------------------------------------------------------------------------------------------------------------------------------------------------------------------------	------------------------------------------------------------------------------------------------------------------------------------------------------------------------------------------------------------------------------------------------------------------	---------------------------------------------------------------------------------------------------------------------------------------------------------------------------------------------------------------------------------------------------------------------------------------------	-----------------------------------------------------------------------------------------------------------------------------------------------------------------------------------------------------------------------------------------------------------------------------------------------

lampadine / bulbs / ampoules / Glühbirnen / bombillas

3x100W (HA) E27 or
 3x33W (FL) E27

IP55

dimensione della lampadina / bulb size / dimension de l'ampoule / Größe des Leuchtmittels / tamaño de la bombilla
 ø 39,6 / 48,0x196,2 mm

	5587BI	Lampada da terra per esterno. Base in ferro e struttura in alluminio, protette con trattamento di cataforesi e verniciate grigio opaco (RAL 9006). Diffusore in polietilene bianco traslucido. La lampada è fornita con 5 metri di cavo cablato e spina in classe di protezione IPX4.	Outdoor floor lamp with iron base and aluminium frame, with cathaphoresis protective coating and matte grey (RAL 9006) finish. Translucent white polyethylene diffuser. The lamp comes with 5 metres of wired cable and IPX4 protection class plug.	Lampadaire d'extérieur. Base en fer et structure en aluminium, traitées en cathaphorèse et peintes en gris mat (RAL 9006). Diffusor en polyéthylène blanc translucide. La lampe est fournie avec 5 mètres de câble équipé de fiche en classe de protection IPX4.	Stehleuchte für den Außenbereich. Basis aus Eisen, Struktur aus Aluminium, durch Kataphorese witterungsgeschützt und mattgrau lackiert (RAL 9006). Diffusor aus weißem durchscheinendem Polyäthylen. Die Leuchte wird mit 5 Meter Kabel und einem Netzstecker der Schutzart IPX4 geliefert.	Lámpara de pie para exteriores. Base de hierro y estructura de aluminio, protegidas con tratamiento de cataforesis y pintadas en gris mate (RAL 9006). Difusor de polietileno blanco translúcido. La lámpara incluye 5 metros de cable con conectores y enchufe con clase de protección IPX4.
--	---------------	---------------------------------------------------------------------------------------------------------------------------------------------------------------------------------------------------------------------------------------------------------------------------------------	-----------------------------------------------------------------------------------------------------------------------------------------------------------------------------------------------------------------------------------------------------	------------------------------------------------------------------------------------------------------------------------------------------------------------------------------------------------------------------------------------------------------------------	---------------------------------------------------------------------------------------------------------------------------------------------------------------------------------------------------------------------------------------------------------------------------------------------	-----------------------------------------------------------------------------------------------------------------------------------------------------------------------------------------------------------------------------------------------------------------------------------------------

lampadine / bulbs / ampoules / Glühbirnen / bombillas

3x100W (HA) E27 or
 3x33W (FL) E27

IP55

dimensione della lampadina / bulb size / dimension de l'ampoule / Größe des Leuchtmittels / tamaño de la bombilla
 ø 39,6 / 48,0x196,2 mm

	5588BI	Lampada a sospensione da esterno. Diffusore in polietilene bianco traslucido. Rosone in ferro protetto con trattamento di cataforesi e verniciato color alluminio anodizzato. Stelo rigido.	Outdoor suspension lamp with translucent white polyethylene diffuser. Iron canopy with cathaphoresis protective coating and anodized aluminium-colour finish. Rigid stem.	Suspension d'extérieur. Diffusor en polyéthylène blanc translucide. Rosace en fer, protégée par un traitement de cathaphorèse et peinte en couleur aluminium anodisé. Tige rigide.	Hängeleuchte für den Außenbereich. Diffusor aus weißem durchscheinendem Polyäthylen. Rosette aus Eisen, durch Kataphorese geschützt und lackiert in der Farbe Aluminium eloxiert. Fester Stiel.	Lámpara de techo para exteriores. Difusor de polietileno blanco translúcido. Florón de hierro protegido con tratamiento de cataforesis y pintado en color aluminio anodizado. Pie rígido.
--	---------------	---------------------------------------------------------------------------------------------------------------------------------------------------------------------------------------------	---------------------------------------------------------------------------------------------------------------------------------------------------------------------------	------------------------------------------------------------------------------------------------------------------------------------------------------------------------------------	-------------------------------------------------------------------------------------------------------------------------------------------------------------------------------------------------	-------------------------------------------------------------------------------------------------------------------------------------------------------------------------------------------

	5562	lampadine / bulbs / ampoules / Glühbirnen / bombillas	3x100W (HA) E27 or 3x33W (FL) E27	IP55
--	-------------	-------------------------------------------------------	---------------------------------------	------

dimensione della lampadina / bulb size / dimension de l'ampoule / Größe des Leuchtmittels / tamaño de la bombilla
 ø 39,6 / 48,0x196,2 mm

	5589	Su questo modello è possibile montare un disco di chiusura opzionale in metacrilato con tige telescopica e tappo di ancoraggio.	This model fits an optional methacrylate cover with telescopic stem and securing plug.	Ce modèle peut être équipé avec un disque optionnel de fermeture en méthacrylate avec tige télescopique et bouchon d'ancrage.	Dieses Modelle kann mit einer Abschlusscheibe aus Methacrylat mit ausziehbarer Stange und Schließkappe geliefert werden.	Este modelo se puede equipar con un disco de cierre opcional en metacrilato con barra telescópica y anclaje.
--	-------------	---------------------------------------------------------------------------------------------------------------------------------	----------------------------------------------------------------------------------------	-------------------------------------------------------------------------------------------------------------------------------	--------------------------------------------------------------------------------------------------------------------------	--------------------------------------------------------------------------------------------------------------

ANANAS

pag. 56

Lampada da parete / Wall lamp / Applique
Wandleuchte / Applique

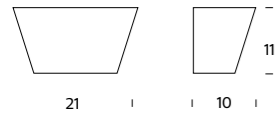

M3302 + V3290...

Lampada da parete. Montatura in metallo nichelato. Diffusore in vetro stratificato ambra **AM** o bianco **BI**. Vetro di chiusura inferiore temperato e sabbiato

Wall lamp. Nickel-plated metal frame. Diffuser available in amber **AM** or white **BI** laminated glass. Tempered, sandblasted glass bottom cover.

Applique. Structure en métal nickelé. Diffuseur en verre stratifié ambre **AM** ou blanc **BI**. Verre de fermeture inférieure trempé et sablé.

Wandleuchte. Gestell aus vernickeltem Metall. Diffusor aus geschichtetem bernsteinfarbenem Glas **AM** oder weißem Glas **BI**. Unterer Abschluss aus getempertem und sandgestrahltem Glas.

Lámpara de pared. Montura de metal niquelado. Difusor de vidrio laminado ámbar **AM** o blanco **BI**. Vidrio de cierre inferior templado y arenado.

lampadine / bulbs / ampoules / Glühbirnen / bombillas

2x40W (IN) E14 or 2x28W (HA) E14



M3304 + V3290...

lampadine / bulbs / ampoules / Glühbirnen / bombillas

1x48W (HA) E14 R7s/80

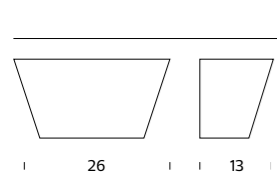

M3302/1+ V3290/1..

Lampada da parete. Montatura in metallo nichelato. Diffusore in vetro stratificato ambra **AM** o bianco **BI**. Vetro di chiusura inferiore temperato e sabbiato

Wall lamp. Nickel-plated metal frame. Diffuser available in amber **AM** or white **BI** laminated glass. Tempered, sandblasted glass bottom cover.

Applique. Structure en métal nickelé. Diffuseur en verre stratifié ambre **AM** ou blanc **BI**. Verre de fermeture inférieure trempé et sablé.

Wandleuchte. Gestell aus vernickeltem Metall. Diffusor aus geschichtetem bernsteinfarbenem Glas **AM** oder weißem Glas **BI**. Unterer Abschluss aus getempertem und sandgestrahltem Glas.

Lámpara de pared. Montura de metal niquelado. Difusor de vidrio laminado ámbar **AM** o blanco **BI**. Vidrio de cierre inferior templado y arenado.

lampadine / bulbs / ampoules / Glühbirnen / bombillas

2x60W (IN) E14 or 2x42W (HA) E14



M3304/1+ V3290/1..

lampadine / bulbs / ampoules / Glühbirnen / bombillas

1x80W (HA) E14 R7s/80



ASHANGHAI

pag. 58

Lampada da tavolo / Table lamp / Lampe de table / Tischleuchte / Lámpara de sobremesa

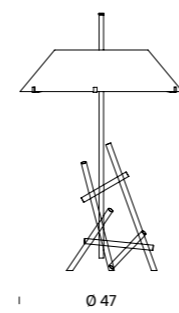

4188TR

Lampada da tavolo con dimmer. Montatura in ottone cromato. Diffusore principale in vetro soffiato incamiciato bianco acidato. Chiusura diffusore superiore in vetro float in lastra sabbiato sui 2 lati. Base realizzata con tubi in vetro borosilicato trasparente. Giunti di fissaggio in ottone cromato. Cavo di alimentazione, dimmer e spina trasparenti.

Table lamp with dimmer. Frame in chrome-plated brass. Main diffuser in white acid-etched cased blown glass. Top of diffuser in float glass sheet sandblasted on both sides. Base made from transparent borosilicate glass. Fixing points in chrome-plated brass. Transparent power cable, dimmer and plug.

Lampe de table avec variateur. Structure en laiton chromé. Diffuseur principal en verre soufflé plaqué blanc dépoli. Fermeture du diffuseur supérieur en verre flotté en plaque, sablé des 2 côtés. Base réalisée avec des tubes de verre borosilicate transparent. Joints de fixation en laiton chromé. Câble d'alimentation, variateur et fiche transparents.

Tischleuchte mit Dimmer. Gestell aus verchromtem Messing. Hauptdiffusor aus mundgeblasenem, weißem, geätztem und mehrschichtigem Glas. Abdeckung des oberen Diffusors aus Float-Glas aus einer auf 2 Seiten sandgestrahlten Scheibe. Rohrbasis aus transparentem Borosilikatglas. Befestigungsverbindungen aus verchromtem Messing. Netzkabel, Dimmer und Netzstecker transparent.

Lámpara de sobremesa con dimmer. Montura de latón cromado. Difusor principal de vidrio soplado doble blanco tratado al ácido. Cierre difusor superior de vidrio float en placa arenado en los 2 lados. Base realizada con tubos de vidrio borosilicato transparente. Juntas de fijación de latón cromado. Cable de alimentación, dimmer y enchufe transparentes.

lampadine / bulbs / ampoules / Glühbirnen / bombillas

3x42W (HA) E14



A TOMIC

pag. 62

Lampada a sospensione / Suspension lamp
Suspension / Pendelleuchte / Suspensión

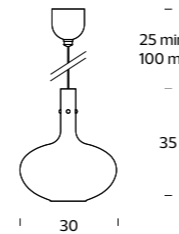

3581

Lampada a sospensione. Montatura in ottone cromato. Diffusore in vetro soffiato bianco opalino. Cavo saliscendi.

Suspension lamp. Chrome-plated brass frame. Diffuser in white opaline blown glass. Rise and fall cable.

Suspension. Structure en laiton chromé. Diffuseur en verre soufflé blanc opalin. Câble réglable avec contrepoids.

Hängeleuchte. Gestell aus verchromtem Messing. Diffusor aus mundgeblasenem weißem Opalglas.

Lámpara de techo. Montura de latón cromado. Difusor de vidrio soplado blanco opalino. Cable para la regulación de la altura con contrapeso.

lampadine / bulbs / ampoules / Glühbirnen / bombillas

1x150W (HA) E27

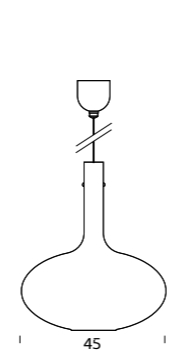

3581/1

Lampada a sospensione. Montatura in ottone cromato. Diffusore in vetro soffiato bianco opalino. Cavo saliscendi.

Suspension lamp. Chrome-plated brass frame. Diffuser in white opaline blown glass. Rise and fall cable.

Suspension. Structure en laiton chromé. Diffuseur en verre soufflé blanc opalin. Câble réglable avec contrepoids.

Hängeleuchte. Gestell aus verchromtem Messing. Diffusor aus mundgeblasenem weißem Opalglas.

Lámpara de techo. Montura de latón cromado. Difusor de vidrio soplado blanco opalino. Cable para la regulación de la altura con contrapeso.

lampadine / bulbs / ampoules / Glühbirnen / bombillas

1x150W (HA) E27



AUREA

pag. 64

Lampada a sospensione / Suspension lamp
Suspension / Pendelleuchte / Suspensión

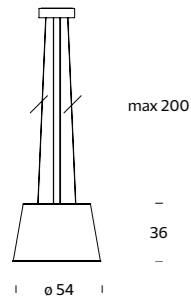

5483
5483...

Lampada a sospensione. Paralume esterno e rosone in alluminio verniciato color alluminio (cod. 5483, 5484), bianco **BI** (RAL 9005 opaco), grigio antracite **N** oppure oro **OO**. Il paralume e il diffusore interno in polipropilene bianco nascondono la sorgente luminosa e producono una luce diffusa e leggera. Il cavo di alimentazione può essere regolato fino a due metri di lunghezza.

Suspension lamp. Hade and canopy exterior in aluminium (cod. 5483, 5484), white **BI** (RAL 9005 matt), anthracite grey **N**, or gold **OO** finish. White polypropylene shade and inner diffuser conceal the light source and cast a soft glow. Power cables adjustable to 2 metres in length.

Suspension. Abat-jour extérieur et rosace en aluminium peint en couleur aluminium (cod. 5483, 5484), blanc **BI** (RAL 9005 mate), gris anthracite **N** ou or **OO**. L'abat-jour et le diffuseur interne en polypropylène blanc cachent la source lumineuse et produisent une lumière diffuse et légère. Le câble d'alimentation peut être réglé jusqu'à deux mètres de longueur.

Hängeleuchte. Äußerer Lampenschirm und Rosette aus Aluminium, lackiert aluminiumfarben (cod. 5483, 5484), weiß **BI** (RAL 9005 matt), grau anthrazit **N** oder goldfarben **OO**. Der innere Lampenschirm und der Diffusor aus weißem Polypropylen verbergen die Lichtquelle und erzeugen somit ein diffuses und leichtes Licht. Das Netzkabel ist bis zu 2 m längenverstellbar.

Lámpara de techo. Pantalla externa y florón de aluminio pintado en color aluminio (cod. 5483, 5484), blanco **BI** (RAL 9005 mate), gris antracita **N** u oro **OO**. La pantalla y el difusor interno de polipropileno blanco ocultan la fuente luminosa y producen una luz difusa y ligera. El cable de alimentación puede regularse hasta un máximo de 2 metros de longitud.

lampadine / bulbs / ampoules / Glühbirnen / bombillas



1x40W (FL) G10Q

5484
5484...

lampadine / bulbs / ampoules / Glühbirnen / bombillas



8 LED 17W (3000K, CRI>80, 2000 Lm, 350mA)

AVICO

pag. 66 (outdoor pag. 326)

Lampada a sospensione / Suspension lamp
Suspension / Pendelleuchte / Suspensión

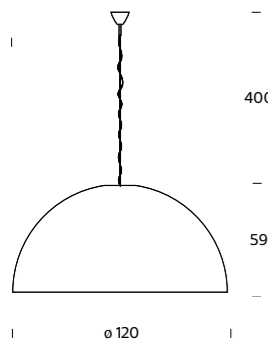

5561/0...

Lampada a sospensione. Montatura e rosone in metallo cromato. Diffusore in polietilene colore bianco all'interno e disponibile all'esterno nei colori bianco **BI** e nero **N/BI** (RAL 9005 opaco). Cavo di sospensione in acciaio. Cavo di alimentazione trasparente eccetto per la versione **BI** dove il cavo è colorato blu. Avico è disponibile su richiesta con diffusore interno bianco e esterno grigio metallizzato **MS/BI** oppure dorato **OO/BI**.

Suspension lamp. Frame and canopy in chromed metal. Diffuser with white polyethylene interior and exterior available in white **BI** or black **N/BI** (RAL 9005 matt). Steel suspension cable. Transparent power cable, the BI version has a blue power cable. On request, the Avico diffuser is available with white interior and metallic silver **MS/BI** or metallic gold **OO/BI** exterior.

Suspension. Structure et rosace en métal chromé. Diffuseur en polyéthylène de couleur blanche à l'intérieur et disponible à l'extérieur dans les couleurs blanc **BI** et noir **N/BI** (RAL 9005 mate). Câble de suspension en acier. Câble d'alimentation transparent, pour la version blanche BI, le câble d'alimentation est bleu. Avico est également disponible sur demande avec diffuseur intérieur blanc et extérieur gris métallisé **MS/BI** ou bien doré **OO/BI**.

Hängeleuchte. Gestell und Rosette aus verchromtem Metall. Diffusor aus Polyäthylen innen weiß und außen in den Farben weiß **BI** und schwarz **N/BI** (RAL 9005 matt) erhältlich. Aufhängekabel aus Stahl. Transparentes Netzkabel, bei der Version BI ist das Netzkabel blau. Auf Nachfrage ist Avico mit dem Diffusor innen weiß, außen grau metallisch **MS/BI** oder goldfarben **OO/BI** erhältlich.

Lámpara de techo. Montura y florón de metal cromado. Difusor de polietileno color blanco en el interior y disponible externamente en los colores blanco **BI** y negro **N/BI** (RAL 9005 mate). Cable de suspensión de acero. Cable de alimentación transparentes, para la versión BI el cable de alimentación es azul. A petición, Avico está disponible con difusor blanco por dentro y gris metalizado **MS/BI** o dorado **OO/BI** por fuera.

lampadine / bulbs / ampoules / Glühbirnen / bombillas



3x100W (HA) E27 or 3x20W (FL) E27

5563/0...

lampadine / bulbs / ampoules / Glühbirnen / bombillas



3x32W (FL) GX24q-3 dimmable 1-10V

5562/0

Su questo modello è possibile montare un disco di chiusura opzionale in metacrilato con tige telescopica e tappo di ancoraggio.

This model fits an optional methacrylate cover with telescopic stem and securing plug.

Ce modèle peut être équipé avec un disque optionel de fermeture en méthacrylate avec tige télescopique et bouchon d'ancrage.

Dieses Modelle kann mit einer Abschlusscheibe aus Methacrylat mit ausziehbarer Stange und Schließkappe geliefert werden.

Este modelo se puede equipar con un disco de cierre opcional en metacrilato con barra telescópica y anclaje.

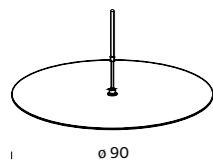

IT EN FR DE ES

5561...

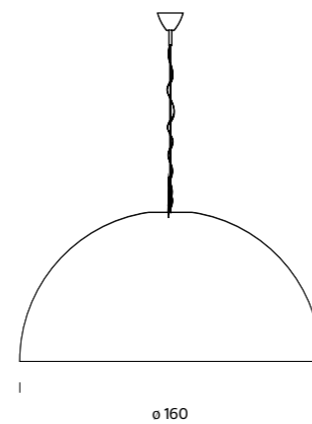

Lampada a sospensione. Montatura e rosone in metallo cromato. Diffusore in polietilene colore bianco all'interno e disponibile all'esterno nei colori bianco **BI** e nero **N/BI** (RAL 9005 opaco). Cavo di sospensione in acciaio. Cavo di alimentazione trasparente eccetto per la versione **BI** dove il cavo è colorato blu. Avico è disponibile su richiesta con diffusore interno bianco e esterno grigio metallizzato **MS/BI** oppure dorato **OO/BI**.

Suspension lamp. Frame and canopy in chromed metal. Diffuser with white polyethylene interior and exterior available in white **BI** or black **N/BI** (RAL 9005 matt). Steel suspension cable. Transparent power cable, the BI version has a blue power cable. On request, the Avico diffuser is available with white interior and metallic silver **MS/BI** or metallic gold **OO/BI** exterior.

Suspension. Structure et rosace en métal chromé. Diffuseur en polyéthylène de couleur blanche à l'intérieur et disponible à l'extérieur dans les couleurs blanc **BI** et noir **N/BI** (RAL 9005 mate). Câble de suspension en acier. Câble d'alimentation transparent, pour la version blanche BI, le câble d'alimentation est bleu. Avico est également disponible sur demande avec diffuseur intérieur blanc et extérieur gris métallisé **MS/BI** ou bien doré **OO/BI**.

Hängeleuchte. Gestell und Rosette aus verchromtem Metall. Diffusor aus Polyäthylen innen weiß und außen in den Farben weiß **BI** und schwarz **N/BI** (RAL 9005 matt) erhältlich. Aufhängekabel aus Stahl. Transparentes Netzkabel, bei der Version BI ist das Netzkabel blau. Auf Nachfrage ist Avico mit dem Diffusor innen weiß, außen grau metallisch **MS/BI** oder goldfarben **OO/BI** erhältlich.

Lámpara de techo. Montura y florón de metal cromado. Difusor de polietileno color blanco en el interior y disponible externamente en los colores blanco **BI** y negro **N/BI** (RAL 9005 mate). Cable de suspensión de acero. Cable de alimentación transparentes, para la versión BI el cable de alimentación es azul. A petición, Avico está disponible con difusor blanco por dentro y gris metalizado **MS/BI** o dorado **OO/BI** por fuera.

lampadine / bulbs / ampoules / Glühbirnen / bombillas



3x150W (HA) E27 or 3x20W (FL) E27

5563...

lampadine / bulbs / ampoules / Glühbirnen / bombillas



3x42W (FL) GX24q-3 dimmable 1-10V

5562

Su questo modello è possibile montare un disco di chiusura opzionale in metacrilato con tige telescopica e tappo di ancoraggio.

This model fits an optional methacrylate cover with telescopic stem and securing plug.

Ce modèle peut être équipé avec un disque optionel de fermeture en méthacrylate avec tige télescopique et bouchon d'ancrage.

Dieses Modelle kann mit einer Abschlusscheibe aus Methacrylat mit ausziehbarer Stange und Schließkappe geliefert werden.

Este modelo se puede equipar con un disco de cierre opcional en metacrilato con barra telescópica y anclaje.

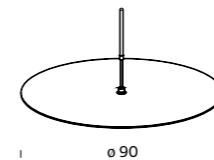

Esterno / Outdoor / Extérieur
Außen / Exterior

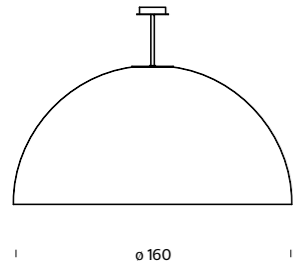

30
80
o 160

IT	EN	FR	DE	ES	
5595BI	Lampada a sospensione per esterno. Diffusore in polietilene bianco traslucido. Rosone in ferro protetto con trattamento di cataforesi e verniciato color alluminio anodizzato. Stelo rigido.	Outdoor suspension lamp with translucent white polyethylene diffuser. Iron canopy with cataphoresis protective coating and anodized aluminium-colour finish. Rigid stem.	Suspension d'extérieur. Diffuseur en polyéthylène blanc translucide. Rosace en fer, protégée par un traitement cataphorèse et peinte en couleur aluminium anodisé. Tige rigide.	Hängeleuchte für den Außenbereich. Diffusor aus weißem durchscheinenden Polyäthylen. Rosette aus Eisen, durch Kataphorese geschützt und lackiert in der Farbe Aluminium eloxiert. Fester Stiel.	Lámpara de techo para exteriores. Difusor de polietileno blanco translúcido. Rosetón en hierro protegido por cataforesis y acabado con pintura gris opaca. Varilla rígida.
<p>lampadine / bulbs / ampoules / Glühbirnen / bombillas</p> <p>dimensione della lampadina / bulb size / dimension de l'ampoule / Größe des Leuchtmittels / tamaño de la bombilla o 39,6 / 48,0x196,2 mm</p> <p>CE IP55 ENE A-E</p> <p>3x100W (HA) E27 or 3x33W (FL) E27</p>					

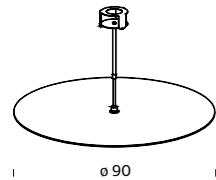

5589	Su questo modello è possibile montare un disco di chiusura opzionale in metacrilato con tige telescopica e tappo di ancoraggio.	This model fits an optional methacrylate stem and securing plug.	Ce modèle peut être équipé avec un disque optionnel de fermeture en méthacrylate avec tige télescopique et bouchon d'ancrage.	Dieses Modelle kann mit einer Abschlusscheibe aus Methacrylat mit ausziehbarer Stange und Schließkappe geliefert werden.	Este modelo se puede equipar con un disco de cierre opcional en metacrilato con barra telescópica y anclaje.
-------------	---------------------------------------------------------------------------------------------------------------------------------	------------------------------------------------------------------	-------------------------------------------------------------------------------------------------------------------------------	--------------------------------------------------------------------------------------------------------------------------	--------------------------------------------------------------------------------------------------------------

BIANCA
pag. 70

Lampada da tavolo / Table lamp / Lampe de table / Tischleuchte / Lámpara de sobremesa

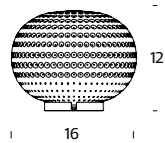

IT	EN	FR	DE	ES	
4308/OBI	Lampada da tavolo. Diffusore in vetro in vetro incamiciato di colore bianco latte, soffiato e satinato. Base in metallo bianco. Cavo di alimentazione e spina trasparente.	Table lamp. Glass diffuser made of milky white cased glass, blown and satin-finished. White metal base. Transparent plug and power cord.	Lampe de table. Diffuseur en verre doublé blanc laiteux, soufflé et satiné. Socle en métal blanc. Câble d'alimentation et fiche transparent.	Tischleuchte. Schirm aus geblasenem und satiniertem Glas mit milchweißer Lackierung. Standfuß aus weißem Metall. Transparentes Stromkabel und Stecker.	Lámpara de mesa. Difusor de vidrio encamisado color blanco leche, soplado y satinado. Base de metal blanco. Cable de alimentación y clavija transparente.
<p>lampadine / bulbs / ampoules / Glühbirnen / bombillas</p> <p>CE IP20 ENE A++</p> <p>LED - 4,5W (2700 K, CRI>80, 350 Lm) 230V</p>					

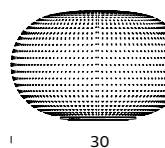

4308BI	Lampada da tavolo. Diffusore in vetro in vetro incamiciato di colore bianco latte, soffiato e satinato. Base in metallo bianco. Cavo di alimentazione e spina trasparente.	Table lamp. Glass diffuser made of milky white cased glass, blown and satin-finished. White metal base. Transparent plug and power cord.	Lampe de table. Diffuseur en verre doublé blanc laiteux, soufflé et satiné. Socle en métal blanc. Câble d'alimentation et fiche transparent.	Tischleuchte. Schirm aus geblasenem und satiniertem Glas mit milchweißer Lackierung. Standfuß aus weißem Metall. Transparentes Stromkabel und Stecker.	Lámpara de mesa. Difusor de vidrio encamisado color blanco leche, soplado y satinado. Base de metal blanco. Cable de alimentación y clavija transparente.
<p>lampadine / bulbs / ampoules / Glühbirnen / bombillas</p> <p>CE IP20 ENE A++</p> <p>LED - 17,5W (2700 K, CRI>80, 1650 Lm) 230V + DIMMER</p>					

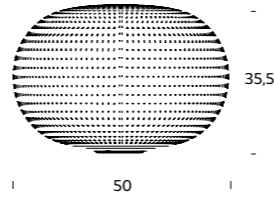

IT	EN	FR	DE	ES	
4308/1BI	Lampada da tavolo. Diffusore in vetro in vetro incamiciato di colore bianco latte, soffiato e satinato. Base in metallo bianco. Cavo di alimentazione e spina trasparente.	Table lamp. Glass diffuser made of milky white cased glass, blown and satin-finished. White metal base. Transparent plug and power cord.	Lampe de table. Diffuseur en verre doublé blanc laiteux, soufflé et satiné. Socle en métal blanc. Câble d'alimentation et fiche transparent.	Tischleuchte. Schirm aus geblasenem und satiniertem Glas mit milchweißer Lackierung. Standfuß aus weißem Metall. Transparentes Stromkabel und Stecker.	Lámpara de mesa. Difusor de vidrio encamisado color blanco leche, soplado y satinado. Base de metal blanco. Cable de alimentación y clavija transparente.

lampadine / bulbs / ampoules / Glühbirnen / bombillas

CE IP20 ENE D-A

1x150W E27 (HA / FL / LED) 230V + DIMMER

Lampada da tavolo / Table lamp / Lampe de table / Tischleuchte / Lámpara de sobremesa

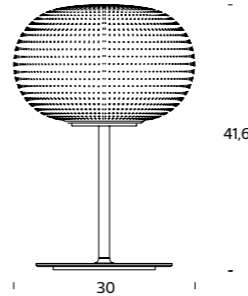

IT	EN	FR	DE	ES	
4307BI	Lampada da tavolo. Diffusore in vetro in vetro incamiciato di colore bianco latte, soffiato e satinato. Base e stelo in metallo bianco. Cavo di alimentazione, spina e dimmer trasparente.	Table lamp. Glass diffuser made of milky white cased glass, blown and satin-finished. White metal base and shaft. Transparent dimmer, plug and power cord.	Lampe de table. Diffuseur en verre doublé blanc laiteux, soufflé et satiné. Socle et pied en métal blanc. Câble d'alimentation, fiche et variateur transparent.	Tischleuchte. Schirm aus geblasenem und satiniertem Glas mit milchweißer Lackierung. Standfuß und Ständer aus weißem Metall. Transparentes Stromkabel, Stecker und Dimmer.	Lámpara de mesa. Difusor de vidrio encamisado color blanco leche, soplado y satinado. Base y tallo de metal blanco. Cable de alimentación, clavija y dimmer transparente.

lampadine / bulbs / ampoules / Glühbirnen / bombillas

CE IP20 ENE A++

LED - 17,5W (2700 K, CRI>80, 1650 Lm) 230V + DIMMER

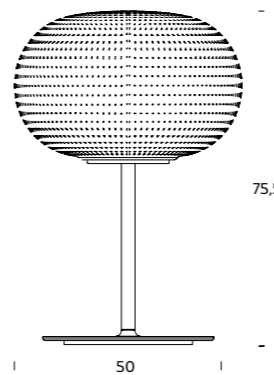

IT	EN	FR	DE	ES	
4307/1BI	Lampada da tavolo. Diffusore in vetro in vetro incamiciato di colore bianco latte, soffiato e satinato. Base e stelo in metallo bianco. Cavo di alimentazione, spina e dimmer trasparente.	Table lamp. Glass diffuser made of milky white cased glass, blown and satin-finished. White metal base and shaft. Transparent dimmer, plug and power cord.	Lampe de table. Diffuseur en verre doublé blanc laiteux, soufflé et satiné. Socle et pied en métal blanc. Câble d'alimentation, fiche et variateur transparent.	Tischleuchte. Schirm aus geblasenem und satiniertem Glas mit milchweißer Lackierung. Standfuß und Ständer aus weißem Metall. Transparentes Stromkabel, Stecker und Dimmer.	Lámpara de mesa. Difusor de vidrio encamisado color blanco leche, soplado y satinado. Base y tallo de metal blanco. Cable de alimentación, clavija y dimmer transparente.

lampadine / bulbs / ampoules / Glühbirnen / bombillas

CE IP20 ENE D-A

1x150W E27 (HA / FL / LED) 230V + DIMMER

Lampada da terra / Floor lamp / Lampadaire
Stehleuchte / Lámpara de pie

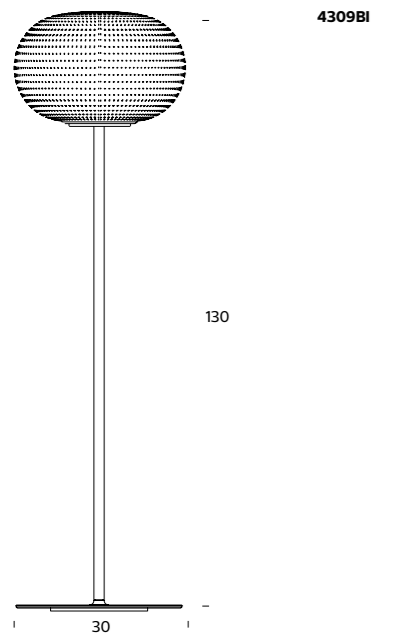

4309BI

IT	EN	FR	DE	ES
Lampada da terra. Diffusore in vetro in vetro incamiciato di colore bianco latte, soffiato e satinato. Base e stelo in metallo bianco. Cavo di alimentazione, spina e dimmer trasparente.	Floor-standing lamp. Glass diffuser made of milky white cased glass, blown and satin-finished. White metal base and shaft. Transparent dimmer, plug and power cord.	Lampe de sol. Diffuseur en verre doublé blanc laiteux, soufflé et satiné. Socle et pied en métal blanc. Câble d'alimentation, fiche et variateur transparent.	Stehleuchte. Schirm aus geblasenem und satiniertem Glas mit milchweißer Lackierung. Standfuß und Ständer aus weißem Metall. Transparentes Stromkabel, Stecker und Dimmer.	Lámpara de suelo. Difusor de vidrio encamisado color blanco leche, soplado y satinado. Base y tallo de metal blanco. Cable de alimentación, clavija y dimmer transparente.

lampadine / bulbs / ampoules / Glühbirnen / bombillas

 ○ LED - 17,5W (2700 K, CRI>80, 1650 Lm) 230V + DIMMER

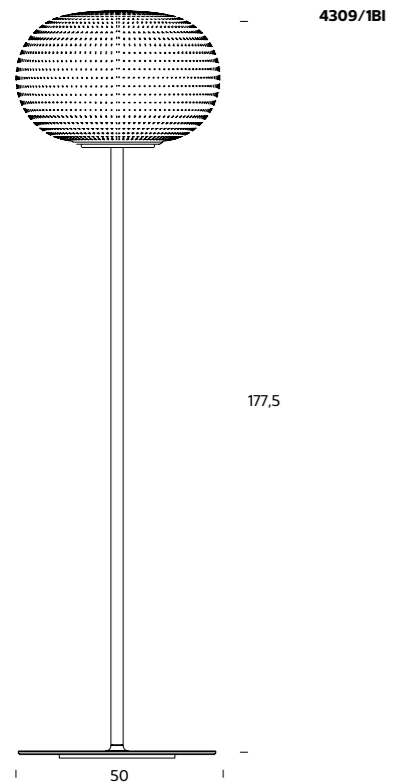

4309/1BI

IT	EN	FR	DE	ES
Lampada da terra. Diffusore in vetro in vetro incamiciato di colore bianco latte, soffiato e satinato. Base e stelo in metallo bianco. Cavo di alimentazione, spina e dimmer trasparente.	Floor-standing lamp. Glass diffuser made of milky white cased glass, blown and satin-finished. White metal base and shaft. Transparent dimmer, plug and power cord.	Lampe de sol. Diffuseur en verre doublé blanc laiteux, soufflé et satiné. Socle et pied en métal blanc. Câble d'alimentation, fiche et variateur transparent.	Stehleuchte. Schirm aus geblasenem und satiniertem Glas mit milchweißer Lackierung. Standfuß und Ständer aus weißem Metall. Transparentes Stromkabel, Stecker und Dimmer.	Lámpara de suelo. Difusor de vidrio encamisado color blanco leche, soplado y satinado. Base y tallo de metal blanco. Cable de alimentación, clavija y dimmer transparente.

lampadine / bulbs / ampoules / Glühbirnen / bombillas

 ○ 1x150W E27 (HA / FL / LED) 230V + DIMMER

Lampada da parete e plafone / Wall and ceiling
lamp / Applique ou plafonnier / Deckenleuchte /
Applique y plafón

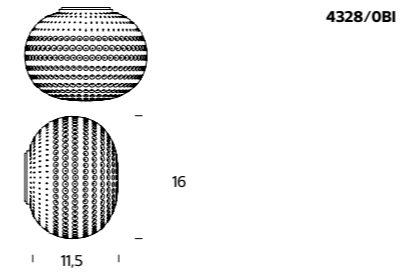

4328/OBI

IT	EN	FR	DE	ES
Lampada da parete/plafone. Diffusore in vetro in vetro incamiciato di colore bianco latte, soffiato e satinato. Montatura in metallo bianco.	Wall/ceiling lamp. Glass diffuser made of milky white cased glass, blown and satin-finished. White metal mount.	Lampe murale/plafond. Diffuseur en verre doublé blanc laiteux, soufflé et satiné. Monture en métal blanc.	Wand-/Deckenleuchte. Schirm aus geblasenem und satiniertem Glas mit milchweißer Lackierung. Gestell aus weißem Metall.	Lámpara de pared/plafón. Difusor de vidrio encamisado color blanco leche, soplado y satinado. Armazón de metal blanco.

lampadine / bulbs / ampoules / Glühbirnen / bombillas

 ○ LED - 4,5W (2700 K, CRI>80, 350 Lm) 230V

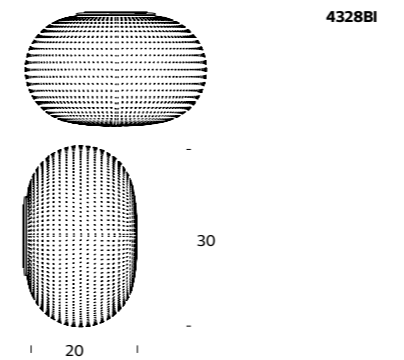

4328BI

IT	EN	FR	DE	ES
Lampada da parete/plafone. Diffusore in vetro in vetro incamiciato di colore bianco latte, soffiato e satinato. Montatura in metallo bianco.	Wall/ceiling lamp. Glass diffuser made of milky white cased glass, blown and satin-finished. White metal mount.	Lampe murale/plafond. Diffuseur en verre doublé blanc laiteux, soufflé et satiné. Monture en métal blanc.	Wand-/Deckenleuchte. Schirm aus geblasenem und satiniertem Glas mit milchweißer Lackierung. Gestell aus weißem Metall.	Lámpara de pared/plafón. Difusor de vidrio encamisado color blanco leche, soplado y satinado. Armazón de metal blanco.

lampadine / bulbs / ampoules / Glühbirnen / bombillas

 ○ LED - 17,5W (2700 K, CRI>80, 1650 Lm) 230V

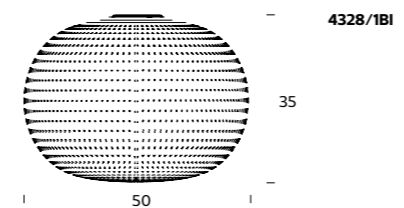

4328/1BI

IT	EN	FR	DE	ES
Lampada da plafone. Diffusore in vetro in vetro incamiciato di colore bianco latte, soffiato e satinato. Montatura in metallo bianco.	Ceiling lamp. Glass diffuser made of milky white cased glass, blown and satin-finished. White metal mount.	Lampe plafond. Diffuseur en verre doublé blanc laiteux, soufflé et satiné. Monture en métal blanc.	Deckenleuchte. Schirm aus geblasenem und satiniertem Glas mit milchweißer Lackierung. Gestell aus weißem Metall.	Lámpara de plafón. Difusor de vidrio encamisado color blanco leche, soplado y satinado. Armazón de metal blanco.

lampadine / bulbs / ampoules / Glühbirnen / bombillas

 ○ 1x150W E27 (HA / FL / LED) 230V + DIMMER

Lampada a sospensione / Suspension lamp
Suspension / Pendelleuchte / Suspensión

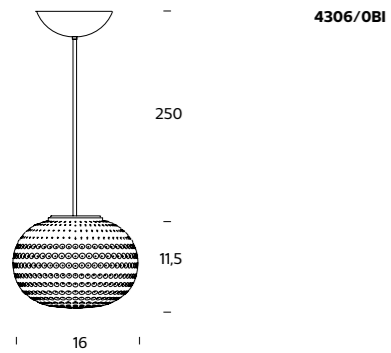

IT	EN	FR	DE	ES
4306/OBI Lampada a sospensione. Diffusore in vetro in vetro incamiciato di colore bianco latte, soffiato e satinato. Rosone colore bianco. Cavo di sospensione in acciaio. Cavo di alimentazione trasparente.	Pendant lamp. Glass diffuser made of milky white cased glass, blown and satin-finished. White ceiling rose. Steel suspension cable. Transparent power cord.	Suspension. Diffuseur en verre doublé blanc laiteux, soufflé et satiné. Rosace de couleur blanche. Filin de suspension en acier. Câble d'alimentation transparent.	Hängeleuchte Schirm aus geblasenem und satiniertem Glas mit milchweißer Lackierung. Deckenkappe weiß. Hängekabel aus Stahl. Transparentes Stromkabel.	Lámpara de suspensión. Difusor de vidrio encamisado color blanco leche, soplado y satinado. Rosetón color blanco. Cable de suspensión de acero. Cable de alimentación transparente.

lampadine / bulbs / ampoules / Glühbirnen / bombillas

○ LED -4,5W (2700 K, CRI>80, 350 Lm) 230V

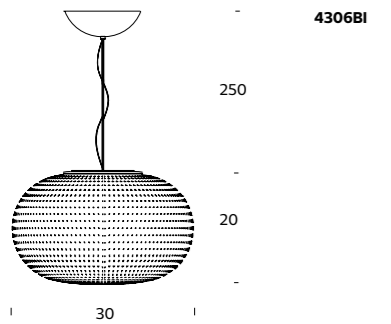

IT	EN	FR	DE	ES
4306BI Lampada a sospensione. Diffusore in vetro in vetro incamiciato di colore bianco latte, soffiato e satinato. Rosone colore bianco. Cavo di sospensione in acciaio. Cavo di alimentazione trasparente.	Pendant lamp. Glass diffuser made of milky white cased glass, blown and satin-finished. White ceiling rose. Steel suspension cable. Transparent power cord.	Suspension. Diffuseur en verre doublé blanc laiteux, soufflé et satiné. Rosace de couleur blanche. Filin de suspension en acier. Câble d'alimentation transparent.	Hängeleuchte Schirm aus geblasenem und satiniertem Glas mit milchweißer Lackierung. Deckenkappe weiß. Hängekabel aus Stahl. Transparentes Stromkabel.	Lámpara de suspensión. Difusor de vidrio encamisado color blanco leche, soplado y satinado. Rosetón color blanco. Cable de suspensión de acero. Cable de alimentación transparente.

lampadine / bulbs / ampoules / Glühbirnen / bombillas

○ LED -17,5W (2700 K, CRI>80, 1650 Lm) 230V

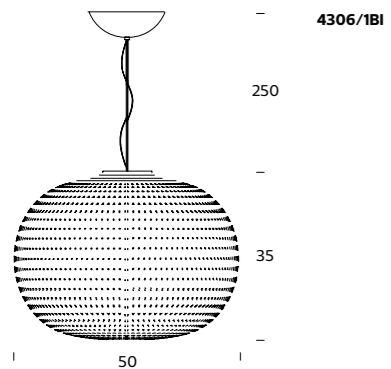

IT	EN	FR	DE	ES
4306/IBI Lampada a sospensione. Diffusore in vetro in vetro incamiciato di colore bianco latte, soffiato e satinato. Rosone colore bianco. Cavo di sospensione in acciaio. Cavo di alimentazione trasparente.	Pendant lamp. Glass diffuser made of milky white cased glass, blown and satin-finished. White ceiling rose. Steel suspension cable. Transparent power cord.	Suspension. Diffuseur en verre doublé blanc laiteux, soufflé et satiné. Rosace de couleur blanche. Filin de suspension en acier. Câble d'alimentation transparent.	Hängeleuchte Schirm aus geblasenem und satiniertem Glas mit milchweißer Lackierung. Deckenkappe weiß. Hängekabel aus Stahl. Transparentes Stromkabel.	Lámpara de suspensión. Difusor de vidrio encamisado color blanco leche, soplado y satinado. Rosetón color blanco. Cable de suspensión de acero. Cable de alimentación transparente.

lampadine / bulbs / ampoules / Glühbirnen / bombillas

○ 1x150W E27 (HA / FL / LED) 230V + DIMMER

BILIA

pag. 82

Lampada da tavolo / Table lamp / Lampe de table / Tischleuchte / Lámpara de sobremesa

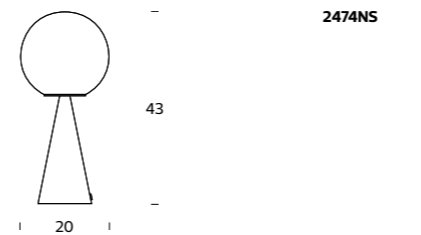

IT	EN	FR	DE	ES
2474NS Lampada da tavolo con dimmer. Montatura in metallo nichelato spazzolato. Diffusore in vetro soffiato bianco satinato. Cavo di alimentazione, dimmer e spina trasparenti.	Table lamp with dimmer. Brushed nickel-plated metal frame. Diffuser in frosted white blown glass. Transparent power cable, dimmer and plug.	Suspension. Structure et Lampe de table avec variateur. Structure en métal nickelé brossé. Diffuseur en verre soufflé blanc satiné. Câble d'alimentation, variateur et fiche transparents.	Tischleuchte mit Dimmer. Gestell aus vernickeltem, gebürstetem Metall. Diffusor aus weißem mundgeblasenem und satiniertem Glas. Netzkabel, Dimmer und Netzstecker transparent.	Lámpara de sobremesa con dimmer. Montura de metal niquelado cepillado. Difusor de vidrio soplado blanco satinado. Cable de alimentación, dimer y enchufe transparentes.

lampadine / bulbs / ampoules / Glühbirnen / bombillas

⦿ 1x60W (IN) E14 or
 ⦿ 1x42W (HA) Ⓢ E14

BIS, TRIS

pag. 84

Lampada da tavolo / Table lamp / Lampe de table / Tischleuchte / Lámpara de sobremesa

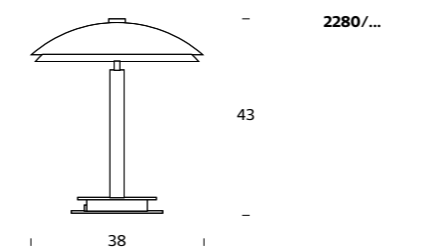

IT	EN	FR	DE	ES
2280/... Lampada da tavolo. Diffusore inferiore in vetro bianco sabbia. BIS, montatura in ottone lucido. Coppa in vetro opale nero, sabbia e verniciata nera internamente. TRIS, montatura in metallo cromato. Coppa in vetro, sabbia e verniciata bianca internamente. Cavo di alimentazione, interruttore e spina neri.	Table lamp. Lower diffuser in white sandblasted glass. BIS, polished brass frame. Bowl in black opaline glass, sandblasted and black interior finish. TRIS, chromed metal frame. Glass bowl, sandblasted and white interior finish. Black power cable, plug and switch.	Lampe de table. Diffuseur inférieur en verre blanc sablé. BIS, structure en laiton brillant. Coupe en verre opalin noir, sablé et peint en noir à l'intérieur. TRIS, structure en métal chromé. Coupe en verre, sablé, intérieur peint en blanc. Câble d'alimentation, fiche et interrupteur noirs.	Tischlampe. Unterer Diffusor aus weißem sandgestrahltem Glas. BIS, Gestell aus poliertem Messing. Schale aus schwarzem Opalglas, gesandstrahlt und innen schwarz lackiert. TRIS, Gestell aus verchromtem Metall. Glasschale, gesandstrahlt und innen weiß lackiert. Netzkabel, Netzstecker und Schalter schwarz.	Lámpara de sobremesa. Difusor inferior de vidrio blanco arenado. BIS, montura de latón brillante. Copa de vidrio opalino negro, arenada y pintada de negro en el interior. TRIS, montura de metal cromado. Copa de vidrio, arenada y pintada de blanco en el interior. Cable de alimentación, enchufe e interruptor negros.

lampadine / bulbs / ampoules / Glühbirnen / bombillas

⦿ 4x40W (IN) E14 or
 ⦿ 4x28W (HA) Ⓢ E14

BLOM

pag. 88

Lampada da tavolo / Table lamp / Lampe de table / Tischleuchte / Lámpara de sobremesa

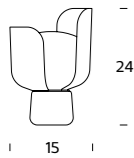

4253...

Lampada da tavolo. Diffusore in polietilene opalino bianco latte, petali in policarbonato, base in alluminio verniciato. Emissione luminosa diffusa e regolabile grazie alla rotazione sulla base dei petali. Disponibile: rosso **R** (RAL 3003 opaco), grigio **G** (RAL 7044 opaco), verde **V** (RAL 6021 opaco), bianco **BI** (RAL 9010 opaco) e nero **N** (RAL 9005 opaco). Interruttore su cavo trasparente.

Table lamp. Diffuser in milk white opaline polyethylene, petals in polycarbonate, base in painted aluminium. Diffused light emission adjusted by moving the petals. Available: red **R** (RAL 3003 matt), grey **G** (RAL 7044 matt), green **V** (RAL 6021 matt), yellow **GI** (RAL 1021 matt), white **BI** (RAL 9010 matt) and black **N** (RAL 9005 matt). Switch on transparent cable.

Lampe de table. Diffuseur en polyéthylène blanc laiteux opalin, pétales en polycarbonate, base en aluminium laqué. Émission de lumière diffusée, réglable par déplacement des pétales. Disponible: rouge **R** (RAL 3003 mate), gris **G** (RAL 7044 mate), vert **V** (RAL 6021 mate), vert **VM** (RAL 6028 mate), jaune **GI** (RAL 1021 mate), blanc **BI** (RAL 9010 mate) et noir **N** (RAL 9005 mate). Interrupteur sur câble de couleur transparent.

Tischleuchte. Diffusor aus opalweißem Polyethylen, Blütenblätter aus Polycarbonat, lackierte Aluminiumbasis. Licht streuend, durch die Bewegung der Blütenblätter regulierbar. Erhältlich: Rot **R** (RAL 3003 matt), Grau **G** (RAL 7044 matt), Grün **V** (RAL 6021 matt), Grün **VM** (RAL 6028 matt), Gelb **GI** (RAL 1021 matt), Weiß **BI** (RAL 9010 matt) und Schwarz **N** (RAL 9005 matt). Schalter an transparentem Kabel.

Lámpara de sobremesa. Difusor de polietileno opalino blanco leche, pétalos de policarbonato, base de aluminio pintado. Emisión luminosa difusa regulable moviendo los pétalos. Disponible: rojo **R** (RAL 3003 mate), gris **G** (RAL 7044 mate), verde **V** (RAL 6021 mate), verde **VM** (RAL 6028 mate), amarillo **GI** (RAL 1021 mate), blanco **BI** (RAL 9010 mate) y negro **N** (RAL 9005 mate). Interruptor en cable de color transparente.

lampadine / bulbs / ampoules / Glühbirnen / bombillas



1x11W (FL) E14

BOLLA

pag. 92

Lampada a sospensione / Suspension lamp / Suspension / Pendelleuchte / Suspensión

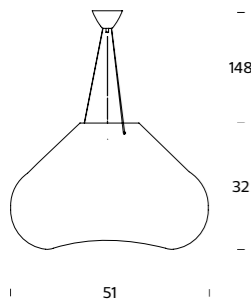

M3540CR + V3567/ITR

Lampada a sospensione. Diffusore in vetro soffiato trasparente con effetto iridescente. Rosone cromato. Cavo di alimentazione blu. Cavi di sospensione in acciaio.

Suspension lamp. Diffuser in transparent iridescent-effect blown glass. Chromed canopy. Blue power cable. Steel suspension cables.

Suspension. Diffuseur en verre soufflé transparent à effet iridescent. Rosace chromée. Câble d'alimentation bleu. Câbles de suspension en acier.

Hängeleuchte. Diffusor aus mundgeblasenem transparentem Glas mit Regenbogeneffekt. Rosette verchromt. Blaues Netzkabel. Stahlseil zum Aufhängen.

Lámpara de techo. Difusor de vidrio soplado transparente con efecto iridescente. Florón cromado. Cable de alimentación azul. Cables de suspensión de acero.

M3540CR montatura
V3567/ITR diffusore

M3540CR frame
V3567/ITR diffuser

M3540CR structure
V3567/ITR diffuseur

M3540CR Gestell
V3567/ITR Diffusor

M3540CR montura
V3567/ITR difusor

lampadine / bulbs / ampoules / Glühbirnen / bombillas



1x105W (HA) E27

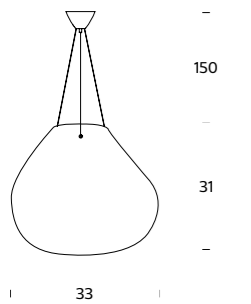

M3540CR + V3567/2TR

Lampada a sospensione. Diffusore in vetro soffiato trasparente con effetto iridescente. Rosone cromato. Cavo di alimentazione blu. Cavi di sospensione in acciaio.

Suspension lamp. Diffuser in transparent iridescent-effect blown glass. Chromed canopy. Blue power cable. Steel suspension cables.

Suspension. Diffuseur en verre soufflé transparent à effet iridescent. Rosace chromée. Câble d'alimentation bleu. Câbles de suspension en acier.

Hängeleuchte. Diffusor aus mundgeblasenem transparentem Glas mit Regenbogeneffekt. Rosette verchromt. Blaues Netzkabel. Stahlseil zum Aufhängen.

Lámpara de techo. Difusor de vidrio soplado transparente con efecto iridescente. Florón cromado. Cable de alimentación azul. Cables de suspensión de acero.

M3540CR montatura
V3567/2TR diffusore

M3540CR frame
V3567/2TR diffuser

M3540CR structure
V3567/2TR diffuseur

M3540CR Gestell
V3567/2TR Diffusor

M3540CR montura
V3567/2TR difusor

lampadine / bulbs / ampoules / Glühbirnen / bombillas

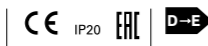

1x105W (HA) E27

BONNET

pag. 96

Lampada da parete / Wall lamp / Applique / Wandleuchte / Aplique

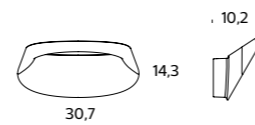

4248...

Lampada da parete. Corpo in pressofusione di alluminio, disponibile alluminio lucidato **AL** oppure bianco **BI** (RAL 9010). Quest'ultima, grazie ad un particolare trattamento superficiale, può essere verniciata direttamente dal cliente.

Wall lamp. Body in die-cast aluminum, available in polished aluminum **AL** or white **BI** (RAL 9010). Thanks to a special surface treatment, the latter can be directly painted by the client.

Applique. Corps en aluminium moulé sous pression, disponible en aluminium poli **AL** ou blanc **BI** (RAL 9010). Grâce à un traitement de surface particulier, cette dernière peut être laquée directement par le client.

Wandleuchte. Körper aus Aluminium-Druckguss, erhältlich poliertes Aluminium **AL** oder Weiß **BI** (RAL 9010). Letztere kann dank einer besonderen Oberflächenbehandlung direkt vom Kunden lackiert werden.

Lámpara de pared. Cuerpo de aluminio moldeado a presión, disponible en aluminio pulido **AL** o blanco **BI** (RAL 9010). Gracias al especial tratamiento de su superficie, esta última puede ser pintada directamente por el cliente.

lampadine / bulbs / ampoules / Glühbirnen / bombillas



LED COB 18W (2700 K, CRI 80, 2050 Lm)

4318...

lampadine / bulbs / ampoules / Glühbirnen / bombillas



LED COB 18W (3000 K, CRI 80, 2150 Lm)

BOTREE

pag. 328

Esterno / Outdoor / Exterieur Außen / Exterior

Apparecchio luminoso da terra per esterno adatto a molteplici configurazioni. Struttura portante costituita da uno o due pali dritti o con una piega. Ogni palo può montare uno o due supporti per i rami luminosi. Struttura e rami in estruso di alluminio con sezione ad "H". I rami sono disponibili con quattro diverse sorgenti luminose, di cui due a LED e due a ioduri metallici. Il riflettore in alluminio speculare garantisce la ripartizione simmetrica del flusso. Vetro di sicurezza temperato trasparente. Vano per gli alimentatori collocato nella parte superiore del ramo. Le sorgenti luminose sono alloggiare in una struttura di acciaio inox verniciata a polvere a base poliestere. Base per palo singolo o per due pali accoppiati, in acciaio zincato verniciato a polvere a base poliestere, completa di tirafondi e di bulloneria in acciaio inox. La base può essere completamente interrata o tenuta fuori terra. Le diverse composizioni della lampada (singola o doppia, la posizione della piega sul palo, il posizionamento dei rami luminosi, la scelta delle sorgenti luminose) devono essere indicate in fase di progettazione. Anche il colore può essere scelto indicando il RAL della verniciatura desiderata. A richiesta è possibile realizzare pali con scatola alloggiamento fusibili collocata a 1 metro da terra. Alimentatore elettronico incluso. Lotto minimo di acquisto 6 pezzi.

Outdoor floor lighting fixture available in several different configurations. The frame comprises one or two poles, each available straight or curved. Each pole can fit up one or two supports for the lighting branches. Frame and branches are in extruded "H" section aluminium. The branches fit four separate light sources, of which two are LEDs and two are metal halide. A mirror-finish aluminium reflector ensures balanced distribution of light flow. Transparent tempered glass shield. Ballast housing positioned in the upper part of the branch. Light sources are housed in a polyester powder-coated stainless steel frame. Zinc-plated, polyester powder-coated steel base available for either single or double pole, provided with stainless steel anchor rods and screws. The base may be installed in the ground or above ground. The various lamp configurations (single or double, curve position, lighting branch position, choice of the light sources) must be defined at the design stage. Finish colours are to be chosen from the RAL catalogue. Poles may be ordered with the fuse box located one metre above ground. Electronic ballast included. Minimum purchase: six pieces.

Lampadaire d'extérieur possédant de nombreuses configurations possibles. Structure portante constituée d'un ou deux mâts droits ou pliés. Chaque mât peut recevoir un ou deux supports d'attaches pour les branches lumineuses. La structure et les branches sont réalisées en aluminium extrudé avec section en "H". Les branches sont disponibles avec quatre différentes sources lumineuses, dont deux à LED et deux à iodures métalliques. Un réflecteur en aluminium spéculaire garantit la répartition symétrique du flux. Verre de sécurité trempé transparent. Logement pour les alimentateurs situés dans la partie supérieure de la branche. Les sources lumineuses sont logées dans une structure en acier inox peinte avec une poudre à base de polyester. Base pour mât simple ou paire de mâts en acier galvanisé, peinte avec une poudre à base de polyester, munie de boulonnerie et tire-fond en acier inox. La base peut être enterrée complètement ou fixée hors-sol. Les diverses compositions de la lampe (simple ou double, l'emplacement de la pliure sur le mât, le positionnement des branches lumineuses, le choix des sources lumineuses) doivent être indiquées en phase de projet. La couleur peut être choisie en indiquant le RAL de la peinture désirée. Sur demande l'on peut réaliser des mâts avec boîte de logement des fusibles placée à 1 mètre du sol. Lot minimum d'achat de 6 pièces.

Außenstehleuchte in verschiedenen Ausführungen. Die Hauptstruktur besteht aus ein oder zwei geraden oder gebogenen Maste. An jedem Mast können ein oder zwei Träger für die Leuchtzweige angebracht werden. Struktur und Zweige aus fließgepresstem Aluminium in H-Form. Die Zweige sind mit vier verschiedenen Leuchtquellen erhältlich, davon zwei mit LED und zwei mit Metall-dampflampen. Der Reflektor aus Spiegelfaluminium garantiert die symmetrische Verteilung des Lichtstroms. Transparentes getempertes Sicherheitsglas. Raum für die Versorgungseinheiten im oberen Teil des Zweigs. Die Leuchtquellen befinden sich in einer auf Polyesterbasis pulverlackierten Edelstahlstruktur. Basis für Einzelmast oder Mastpaar aus verzinktem Stahl, auf Polyesterbasis pulverlackiert, komplett mit Bodenverankerung und Befestigungsschrauben aus Edelstahl. Die Basis kann komplett im Boden versenkt oder auf dem Boden angebracht werden. Die verschiedenen Kompositionen der Leuchte (einzeln oder doppelt, die Biegeposition am Mast, die Positionierung der Leuchtzweige, die Wahl der Leuchtquellen) müssen in der Projektphase angegeben werden. Auch die Farbe kann mit RAL-Angabe ausgewählt werden. Auf Anfrage werden Maste mit Gehäuse für Sicherungen angefertigt, das 1 m über dem Boden liegt. Elektronisches Vorschaltgerät inbegriffen. Mindestauftrag 6 Stck.

Aparato luminoso de pie para exteriores idóneo para realizar múltiples configuraciones. Estructura portante constituida por uno o dos postes rectos o con un pliegue. Cada poste puede alojar uno o dos soportes para las ramas luminosas. Estructura y ramas de aluminio extruido con sección en forma de "H". Las ramas están disponibles con cuatro fuentes luminosas diferentes, dos con LED y dos con halogenuros metálicos. El reflector de aluminio specular garantiza la distribución simétrica del flujo luminoso. Vidrio de seguridad templado transparente. Compartimento para los alimentadores colocado en la parte superior de la rama. Las fuentes luminosas están alojadas en una estructura de acero inoxidable pintada con polvo a base de poliéster. Base para postes simple o doble de acero galvanizado pintado con polvo a base de poliéster, provista de tirafondos y penería de acero inoxidable. La base puede enterrarse completamente o colocarse sobre la superficie. Las diferentes composiciones de la lámpara (individual o doble, la posición del pliegue en el poste, la ubicación de las ramas luminosas, las fuentes luminosas seleccionadas) deben indicarse en la fase de proyecto. También se puede elegir el color indicando el RAL deseado para la pintura. A petición, se pueden realizar postes con caja para alojar los fusibles colocada a 1 metro del suelo. Alimentador electrónico incluido. Lote mínimo de compra 6 piezas.

Pali / Poles / Mâts
Maste / Postes

M4019/1 palo diritto con supporto per 1 ramo	M4019/1 straight pole with support for 1 branch	M4019/1 mât droit avec support d'attache pour 1 branche	M4019/1 gerader Mast mit Träger für 1 Zweig	M4019/1 poste recto con soporte para 1 rama
M4019/2 palo diritto con supporti per 2 rami	M4019/2 straight pole with supports for 2 branches	M4019/2 mât droit avec support d'attache pour 2 branches	M4019/2 gerader Mast mit Trägern für 2 Zweige	M4019/2 poste recto con soporte para 2 ramas
M4019P/1 palo piegato con supporto per 1 ramo	M4019P/1 curved pole with support for 1 branch	M4019P/1 mât plié avec support pour 1 branche	M4019P/1 gebogener Mast mit Träger für 1 Zweig	M4019P/1 poste plegado con soporte para 1 rama
M4019P/2 palo piegato con supporti per 2 rami	M4019P/2 curved pole with support for 2 branches	M4019P/2 mât plié avec support pour 2 branches	M4019P/2 gebogener Mast für Träger mit 2 Zweige	M4019P/2 poste plegado con soportes para 2 ramas
M4019D palo diritto per composizione doppia e supporto per 1 ramo	M4019D straight pole for double composition and support for 1 branch	M4019D mât droit pour composition double et support pour 1 branche	M4019D gerader Mast für Doppelkomposition und Träger für 1 Zweig	M4019D poste recto para composición doble y soporte para 1 rama
M4019P/D palo piegato per composizione doppia e supporto per 1 ramo	M4019P/D curved pole for double composition and support for 1 branch	M4019P/D mât plié pour composition double et support pour 1 branche lumineuse	M4019P/D gebogener Mast für Doppelkomposition und Träger für 1 Zweig	M4019P/D poste plegado para composición doble y soporte para 1

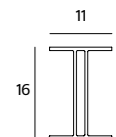
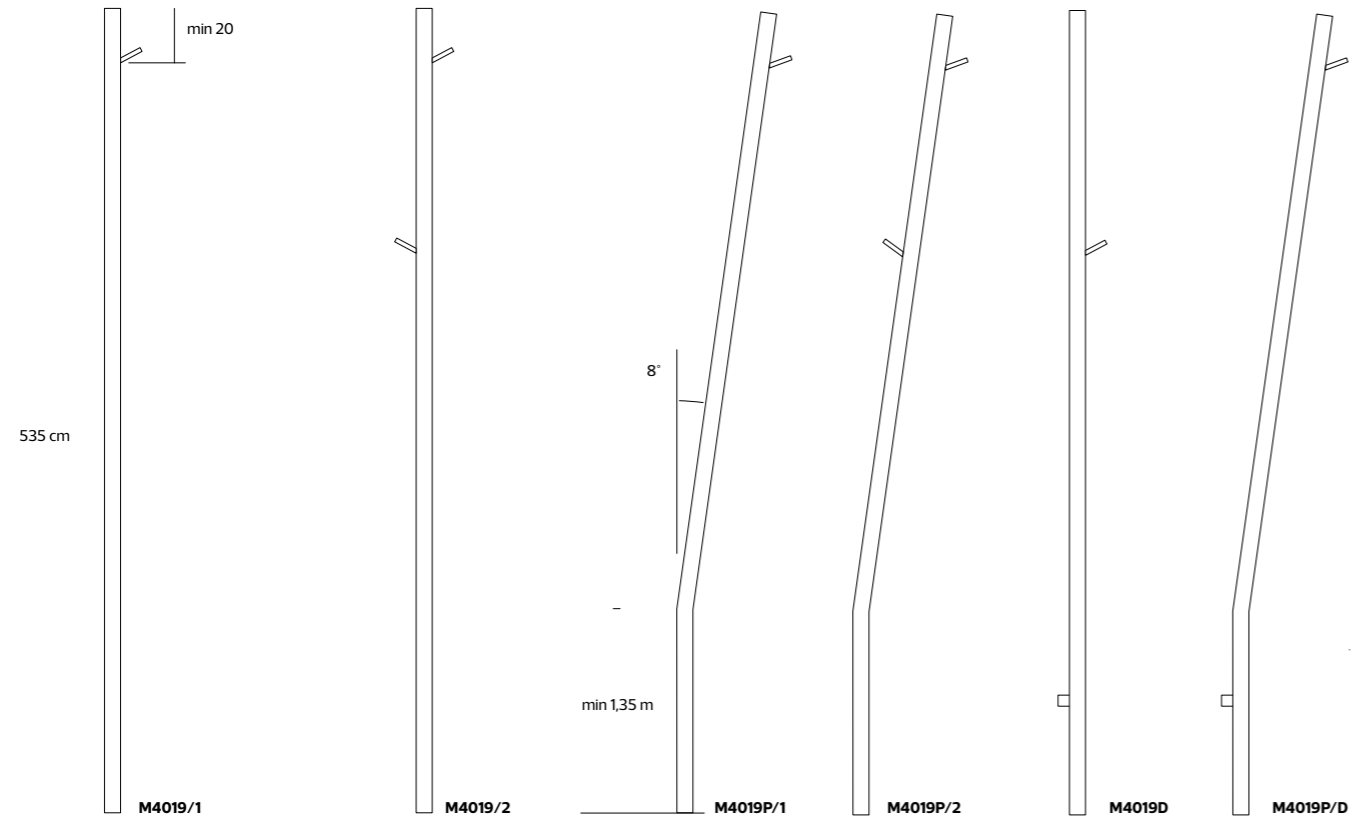

Sezione estruso di alluminio
Section in extruded aluminium
Section en aluminium extrudé
Schnitt fließgepresstes Aluminium
Sección aluminio extruido

Rami / Branches / Branches
Zweige / Ramas

	IT	EN	FR	DE	ES
	Sorgenti luminose a led	Led lighting sources	Sources lumineuses à led	Led- lichtquelle	Fuentes luminosas de led
E4019/3	lampadine / bulbs / ampoules / Glühbirnen / bombillas ○ 3×18W LED (3700 K, CRI 85, 3500 Lm)	CE IP65 Classe #	A++ LED INCL NOT REPLACEABLE		
E4019/1	lampadine / bulbs / ampoules / Glühbirnen / bombillas ○ 1×60W LED (3500 K, CRI 80, 4000 Lm)	CE IP65 Classe #	A++ LED INCL NOT REPLACEABLE		
	Sorgenti luminose a ioduri metallici	Metal halide lighting sources	Sources lumineuses à iodures métalliques	Metaldampf Lichtquelle	Fuentes luminosas de ioduros metálicos
E4019/70	lampadine / bulbs / ampoules / Glühbirnen / bombillas ● 1×70W (MH) G12	CE IP65 Classe #	A+		
E4019/150	lampadine / bulbs / ampoules / Glühbirnen / bombillas ● 1×150W (MH) G12	CE IP65 Classe #	A+		

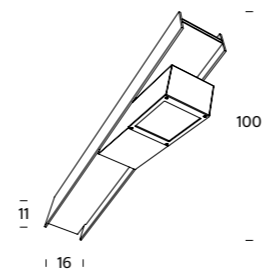
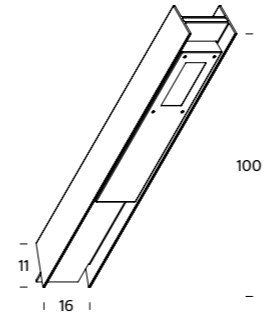
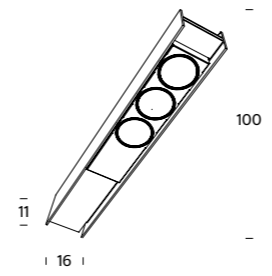

Basi / Bases / Bases Basis / Bases	IT	EN	FR	DE	ES
B4019	Base palo singolo	Single-pole base	Base pour mât simple	Basis für einen Mast	Base poste individual
B4019D	Base pali doppia	Double-pole base	Base pour mâts doubles	Basis für doppelte Maste	Base postes dobles

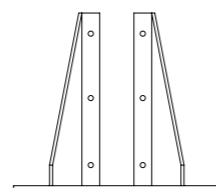
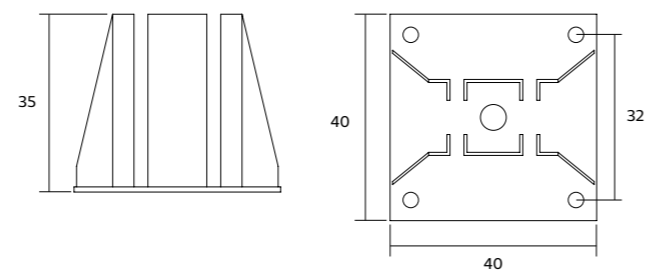
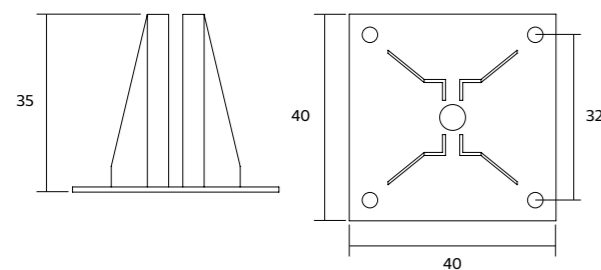
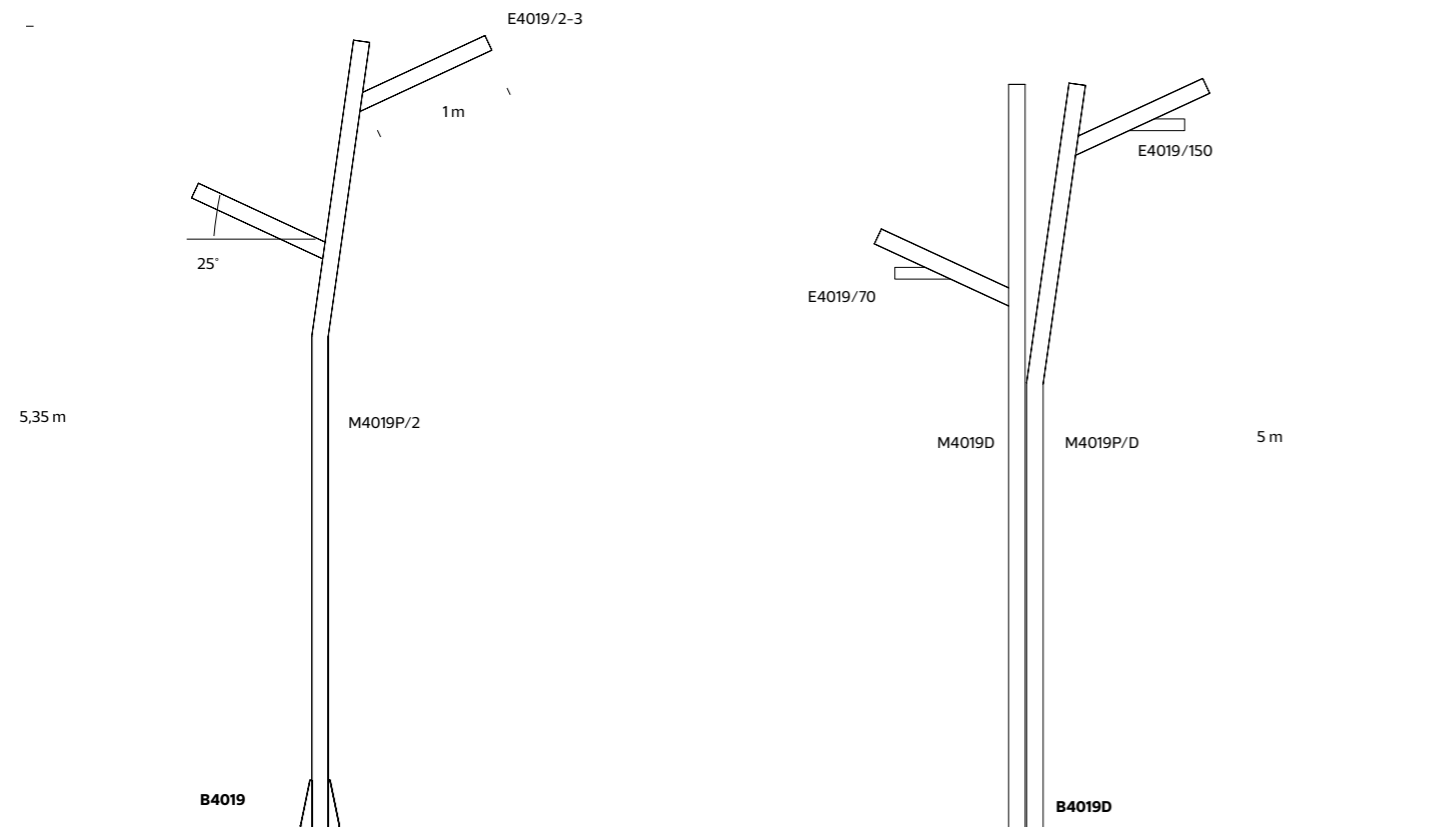

Lampada da parete / Wall lamp / Applique Wandleuchte / Applique	IT	EN	FR	DE	ES
--------------------------------------------------------------------	----	----	----	----	----

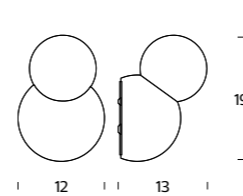

3538

Lampada da parete. Montatura in metallo nichelato. Diffusore in vetro soffiato satinato bianco.

Wall lamp. Nickel-plated metal frame. Diffuser in white frosted blown glass.

Applique. Structure en métal nickelé. Diffuseur en verre soufflé satiné blanc.

Wandleuchte. Gestell aus vernickeltem Metall. Diffusor aus mundgeblasenem weißem satiniertem Glas.

Lámpara de pared. Montura de metal niquelado. Difusor de vidrio soplado satinado blanco.

lampadine / bulbs / ampoules / Glühbirnen / bombillas



• 1x60W (IN) E14 or
• 1x42W (HA) E14

CHANDELIER

pag. 100

Lampada a sospensione / Suspension lamp Suspension / Pendelleuchte / Suspensión	IT	EN	FR	DE	ES
------------------------------------------------------------------------------------	----	----	----	----	----

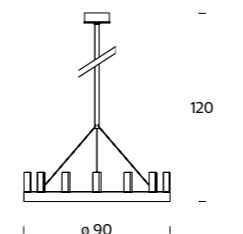

5491...

Lampada a sospensione. Montatura in metallo verniciato grigio alluminio G o nero N (RAL 9005 opaco). Cavi di sospensione in acciaio inox. Diffusori in vetro borosilicato sabbiato.

Suspension lamp. Metal frame with grey aluminium G or black N (RAL 9005 matt) finish. Stainless steel suspension cables. Sandblasted borosilicate glass diffusers.

Suspension. Structure en métal peint en gris aluminium G ou noir N (RAL 9005 mate). Câbles de suspension en acier inox. Diffuseurs en verre borosilicate sablé.

Hängeleuchte. Gestell aus Metall, aluminiumgrau G oder schwarz lackiert N (RAL 9005 matt). Aufhängekabel aus Edelstahl. Diffusoren aus sandgestrahltem Borosilikatglas.

Lámpara de techo. Montura de metal pintado gris aluminio G o negro N (RAL 9005 mate). Cables de suspensión de acero inoxidable. Difusores de vidrio borosilicato arenado.

lampadine / bulbs / ampoules / Glühbirnen / bombillas



• 14x40W (HA) E14 or
• 14x28W (HA) E14

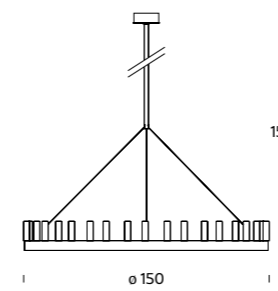

5491/1..

Lampada a sospensione. Montatura in metallo verniciato grigio alluminio G o nero N (RAL 9005 opaco). Cavi di sospensione in acciaio inox. Diffusori in vetro borosilicato sabbiato.

Suspension lamp. Metal frame with grey aluminium G or black N (RAL 9005 matt) finish. Stainless steel suspension cables. Sandblasted borosilicate glass diffusers.

Suspension. Structure en métal peint en gris aluminium G ou noir N (RAL 9005 mate). Câbles de suspension en acier inox. Diffuseurs en verre borosilicate sablé.

Hängeleuchte. Gestell aus Metall, aluminiumgrau G oder schwarz lackiert N (RAL 9005 matt). Aufhängekabel aus Edelstahl. Diffusoren aus sandgestrahltem Borosilikatglas.

Lámpara de techo. Montura de metal pintado gris aluminio G o negro N (RAL 9005 mate). Cables de suspensión de acero inoxidable. Difusores de vidrio borosilicato arenado.

lampadine / bulbs / ampoules / Glühbirnen / bombillas



• 19x40W (HA) E14 or
• 19x28W (HA) E14

Lampada a sospensione / Suspension lamp
Suspension / Pendelleuchte / Suspensión

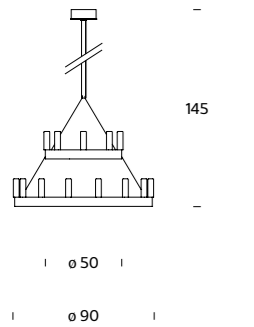

5491/22...

Lampada a sospensione. Montatura in metallo verniciato grigio alluminio **G** o nero **N** (RAL 9005 opaco). Cavi di sospensione in acciaio inox. Diffusori in vetro borosilicato sabbiato. Doppia accensione.

Suspension lamp. Metal frame with grey aluminium **G** or black **N** (RAL 9005 matt) finish. Stainless steel suspension cables. Sandblasted borosilicate glass diffusers. Dual switching.

Suspension. Structure en métal peint en gris aluminium **G** ou noir **N** (RAL 9005 mate). Câbles de suspension en acier inox. Diffuseurs en verre borosilicate sablé. Double allumage.

Hängeleuchte. Gestell aus Metall, aluminiumgrau **G** oder schwarz lackiert **N** (RAL 9005 matt). Aufhängekabel aus Edelstahl. Diffusoren aus sandgestrahltem Borosilikatglas. Doppelschaltung.

Lámpara de techo. Montura de metal pintado gris aluminio **G** o negro **N** (RAL 9005 mate). Cables de suspensión de acero inoxidable. Difusores de vidrio borosilicato arenado. Doble encendido.

lampadine / bulbs / ampoules / Glühbirnen / bombillas
 8x40W (HA) E14 or
 8x28W (HA) E14
 +
 14x40W (HA) E14 or
 14x28W (HA) E14

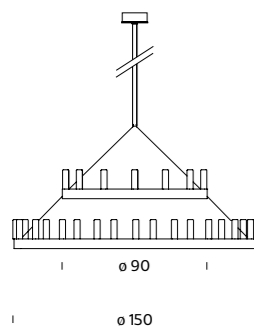

5491/33...

Lampada a sospensione. Montatura in metallo verniciato grigio alluminio **G** o nero **N** (RAL 9005 opaco). Cavi di sospensione in acciaio inox. Diffusori in vetro borosilicato sabbiato. Doppia accensione.

Suspension lamp. Metal frame with grey aluminium **G** or black **N** (RAL 9005 matt) finish. Stainless steel suspension cables. Sandblasted borosilicate glass diffusers. Dual switching.

Suspension. Structure en métal peint en gris aluminium **G** ou noir **N** (RAL 9005 mate). Câbles de suspension en acier inox. Diffuseurs en verre borosilicate sablé. Double allumage.

Hängeleuchte. Gestell aus Metall, aluminiumgrau **G** oder schwarz lackiert **N** (RAL 9005 matt). Aufhängekabel aus Edelstahl. Diffusoren aus sandgestrahltem Borosilikatglas. Doppelschaltung.

Lámpara de techo. Montura de metal pintado gris aluminio **G** o negro **N** (RAL 9005 mate). Cables de suspensión de acero inoxidable. Difusores de vidrio borosilicato arenado. Doble encendido.

lampadine / bulbs / ampoules / Glühbirnen / bombillas
 14x40W (HA) E14 or
 14x28W (HA) E14
 +
 19x40W (HA) E14 or
 19x28W (HA) E14



CHESHIRE

Lampada da tavolo / Table lamp / Lampe de table / Tischleuchte / Lámpara de sobremesa



IT EN FR DE ES

Lampada da tavolo. Diffusore inferiore opalino. Paralume in policarbonato, stelo e base in metallo. Paralume, stelo e base bianco **BI** (RAL 9010 opaco), nero **N** (RAL 7021 opaco), verde **V** (RAL 6013 opaco). Cavo e spina trasparente.

Table lamp. Opal lower diffuser. Lampshade in polycarbonate. Stem and base in metal. Lampshade, stem and base white **BI** (RAL 9010 matt), black **N** (RAL 7021 matt) and green **V** (RAL 6013 matt). Clear cable and plug.

Lampe de table. Diffuseur inférieur opalin. Abat-jour en polycarbonate. Tige et base en métal. Abat-jour, tige et base blanc **BI** (RAL 9010 mate), noir **N** (RAL 7021 mate) ou vert **V** (RAL 6013 mate). Câble et prise transparents.

Tischleuchte. Diffusor weiß transluzent. Polycarbonat-Schirm. Stiel und Basis aus Metall. Diffusor, Stiel und Basis weiß **BI** (RAL 9010 matt), schwarz **N** (RAL 7021 matt) und grün **V** (RAL 6013 matt). Kabel und Stecker transparent.

Lámpara de sobremesa. Pantalla inferior opalina. Pantalla de policarbonato. Pie y base de metal. Pantalla, pie y base blanco **BI** (RAL 9010 mate), negro **N** (RAL 7021 mate) y verde **V** (RAL 6013 mate). Cable y enchufe transparente.

4251... **lampadine / bulbs / ampoules / Glühbirnen / bombillas** 3x23W (FL) E27

4314.. **lampadine / bulbs / ampoules / Glühbirnen / bombillas** 17,5 W LED - (2700 K, CRI >80, 1650 Lm) ON/OFF touch dimmer

Lampada da tavolo. Paralume e diffusore inferiore in policarbonato opalino. Stelo e base in metallo nero. Cavo e spina trasparente.

Table lamp. Shade and lower diffuser in opal polycarbonate. Black stem and base in metal. Clear cable and plug.

Lampe de table. Abat-jour et diffuseur inférieur opalins. Tige et base en métal noir. Câble et prise transparents.

Tischleuchte. Polycarbonat-Schirm und Diffusor weiß transluzent. Stiel und Basis aus schwarzem Metall. Kabel und Stecker transparent.

Lámpara de mesa. Pantalla superior e inferior de policarbonato opalino. Pie y base de metal negro. Cable y enchufe transparente.

4251 **lampadine / bulbs / ampoules / Glühbirnen / bombillas** 1x30W (FL) E27

4314 **lampadine / bulbs / ampoules / Glühbirnen / bombillas** 17,5 W LED - (2700 K, CRI >80, 1650 Lm) ON/OFF touch dimmer

Lampada da terra / Floor lamp / Lampadaire Stehleuchte / Lámpara de pie

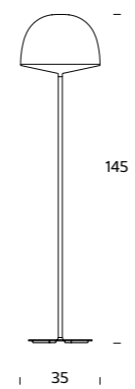

IT EN FR DE ES

Lampada da terra. Diffusore inferiore opalino. Paralume in policarbonato, stelo e base in metallo. Paralume, stelo e base bianco **BI** (RAL 9010 opaco), nero **N** (RAL 7021 opaco), verde **V** (RAL 6013 opaco). Cavo e spina trasparente.

Floor lamp. Opal lower diffuser. Lampshade in polycarbonate. Stem and base in metal. Lampshade, stem and base white **BI** (RAL 9010 matt), black **N** (RAL 7021 matt) and green **V** (RAL 6013 matt). Clear cable and plug.

Lampadaire. Diffuseur inférieur opalin. Abat-jour en polycarbonate. Tige et base en métal. Abat-jour, tige et base blanc **BI** (RAL 9010 mate), noir **N** (RAL 7021 mate) ou vert **V** (RAL 6013 mate). Câble et prise transparents.

Bodenleuchte. Diffusor weiß transluzent. Polycarbonat-Schirm. Stiel und Basis aus Metall. Diffusor, Stiel und Basis weiß **BI** (RAL 9010 matt), schwarz **N** (RAL 7021 matt) und grün **V** (RAL 6013 matt). Kabel und Stecker transparent.

Lámpara de pie. Pantalla inferior opalina. Pantalla de policarbonato. Pie y base de metal. Pantalla, pie y base blanco **BI** (RAL 9010 mate), negro **N** (RAL 7021 mate) y verde **V** (RAL 6013 mate). Cable y enchufe transparente.

4252... **lampadine / bulbs / ampoules / Glühbirnen / bombillas** 3x23W (FL) E27

4315.. **lampadine / bulbs / ampoules / Glühbirnen / bombillas** 17,5 W LED - (2700 K, CRI >80, 1650 Lm)

IT	EN	FR	DE	ES
Lampada da terra. Paralume e diffusore inferiore in policarbonato opalino. Stelo e base in metallo nero. Cavo e spina trasparente.	Floor lamp. Shade and lower diffuser in opal polycarbonate. Black stem and base in metal. Clear cable and plug.	Lampadaire. Abat-jour et diffuseur inférieur opalins. Tige et base en métal noir. Câble et prise transparents.	Bodenleuchte. Polycarbonat-Schirm und Diffusor weiß transluzent. Stiel und Basis aus schwarzem Metall. Kabel und Stecker transparent.	Lámpara de pie. Pantalla superior e inferior de policarbonato opalino. Pie y base de metal negro. Cable y enchufe transparente.
4252	lampadine / bulbs / ampoules / Glühbirnen / bombillas 1x30W (FL) E27			
4315	lampadine / bulbs / ampoules / Glühbirnen / bombillas 17,5 W LED - (2700 K, CRI >80, 1650 Lm)			

Lampada a sospensione / Suspension lamp
Suspension / Pendelleuchte / Suspensión

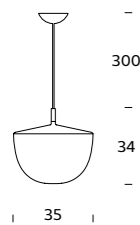

IT	EN	FR	DE	ES
Sospensione. Paralume in policarbonato opalino. Diffusore superiore in policarbonato. Diffusore superiore, stelo e rosone bianco BI (RAL 9010 opaco), nero N (RAL 7021 opaco), verde V (RAL 6013 opaco). Cavo trasparente per la versione bianca, dello stesso colore del paralume nelle altre versioni.	Suspension. Opal polycarbonate lampshade. Upper diffuser in polycarbonate. Upper diffuser, canopy and stem white BI (RAL 9010 matt), black N (RAL 7021 matt) or green V (RAL 6013 matt). Clear power cable for the white version, in the same colour as the lampshade for the other versions.	Suspension. Abat-jour en polycarbonate opalin. Diffuseur supérieur en polycarbonate. Diffuseur supérieur, rosace et tige blanc BI (RAL 9010 mate), noir N (RAL 7021 mate) ou vert V (RAL 6013 mate). Câble d'alimentation transparent pour la version blanche, de la même couleur que l'abat-jour dans les autres versions.	Pendelleuchte. Leuchtschirm aus opalmilchweißem Polycarbonat. Oberer Diffusor, Baldachin und Zugentlastung Weiß BI (RAL 9010 matt), Schwarz N (RAL 7021 matt) oder Grün V (RAL 6013 matt). Transparentes Netzkabel für die Version in Weiß, in der gleichen Farbe des Schirms bei den anderen Versionen.	Lámpara de techo. Pantalla de policarbonato opalino. Difusor superior de policarbonato. Difusor superior, florón y pie blanco BI (RAL 9010 mate), negro N (RAL 7021 mate), verde V (RAL 6013 mate). Cable de alimentación transparente para la versión blanca, del mismo color que la pantalla en las otras ver (blanca, del mismo color que la pantalla en las otras versiones).
4257...	lampadine / bulbs / ampoules / Glühbirnen / bombillas 3x23W (FL) E27			
4316..	lampadine / bulbs / ampoules / Glühbirnen / bombillas 17,5 W LED - (2700 K, CRI >80, 1650 Lm)			
Sospensione. Paralume e diffusore superiore in policarbonato opalino. Rosone e stelo bianco. Cavo trasparente.	Suspension lamp. Shade and upper diffuser in opal polycarbonate. White canopy and stem. Clear power cable.	Suspension. Abat-jour et diffuseur supérieur en polycarbonate opalins. Rosace et tige blancs. Câble d'alimentation transparent.	Pendelleuchte. Leuchtschirm und oberer Diffusor aus Polycarbonat, opalmilchweiß. Baldachin und Zugentlastung weiß. Transparentes Netzkabel.	Lámpara de techo. Pantalla y difusor superior de policarbonato opalino. Florón y pie blancos. Cable de alimentación transparente.
4257	lampadine / bulbs / ampoules / Glühbirnen / bombillas 3x23W (FL) E27			
4316	lampadine / bulbs / ampoules / Glühbirnen / bombillas 17,5 W LED - (2700 K, CRI >80, 1650 Lm)			

CHIARA

pag. 110

Lampada da tavolo / Table lamp / Lampe de table / Tischleuchte / Lámpara de sobremesa

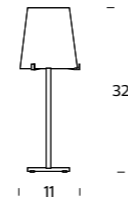

IT	EN	FR	DE	ES	
3504BI	Lampada da tavolo. Montatura in acciaio nichelato spazzolato. Diffusore in vetro soffiato bianco opalino. Cavo di alimentazione, interruttore e spina trasparenti.	Table lamp. Brushed nickel-plated steel frame. Opaline white blown glass diffuser. Transparent power cable, plug and switch.	Lampe de table. Structure en acier nickelé brossé. Diffuseur en verre soufflé blanc opalin. Câble d'alimentation, fiche et interrupteur transparents.	Tischleuchte. Gestell aus vernickeltem gebürstetem Stahl. Diffusor aus weißem mundgeblasenem Opalglas. Netzkabel, Netzstecker und Schalter transparent.	Lámpara de sobremesa. Montura de acero niquelado cepillado. Difusor de vidrio soplado blanco opalino. Cable de alimentación, enchufe e interruptor transparentes
	lampadine / bulbs / ampoules / Glühbirnen / bombillas 1x40W (HA) G9 or 1x33W (HA) G9				

CLOCHE

pag. 112

Lampada a sospensione / Suspension lamp / Suspension / Pendelleuchte / Suspensión

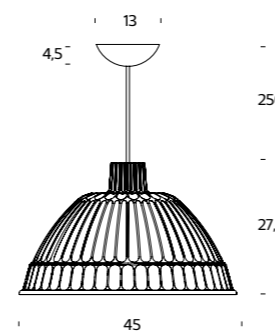

IT	EN	FR	DE	ES	
4260...	Lampada a sospensione. Diffusore in polimero plastico, disponibile grigio chiaro GC (RAL 7044), grigio scuro GS (RAL DESIGN 220 40 05) giallo senape GI (RAL DESIGN 080 60 60) e bianco traslucido BI/TR . Interno del paralume colore bianco. Cavo di alimentazione e rosone nero.	Hanging lamp. Plastic polymer diffuser, available in pale gray GC (RAL 7044), dark gray GS (RAL DESIGN 220 40 05) mustard yellow GI (RAL DESIGN 080 60 60) and translucent white BI/TR . The inside of the lampshade is white. Black power cable and ceiling rose.	Suspension. Diffuseur en polymère plastique, disponible en gris clair GC (RAL 7044), gris foncé GS (RAL DESIGN 220 40 05) jaune moutarde GI (RAL DESIGN 080 60 60) et blanc translucide BI/TR . Intérieur de l'abat-jour de couleur blanche. Câble d'alimentation et rosace de couleur noire.	Pendelleuchte. Diffusor aus Polymer, erhältlich Hellgrau GC (RAL 7044), Dunkelgrau GS (RAL DESIGN 220 40 05) Senfgeb GI (RAL DESIGN 080 60 60) und lichtdurchlässiges Weiß BI/TR . Schirm innen weiß. Netzkabel und Rosette schwarz.	Lámpara de techo. Difusor de polímero plástico, disponible en gris claro GC (RAL 7044), gris oscuro GS (RAL DESIGN 220 40 05) amarillo mostaza GI (RAL DESIGN 080 60 60) y blanco translúcido BI/TR . Interior de la pantalla de color blanco. Cable de alimentación y florón negro.
	lampadine / bulbs / ampoules / Glühbirnen / bombillas 1x40W (FL/LED) E27				

CORRUBEDO

pag. 116 (outdoor pag. 330)

Lampada da parete / Wall lamp / Applique
Wandleuchte / Applique

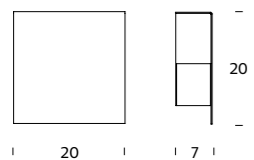

IT	EN	FR	DE	ES
Lampada da parete. Montatura in metallo verniciato bianco lucido BI (RAL 9003 lucido) oppure specchiato SP . Diffusori laterali in vetro satinato.	Wall lamp. Polished white-painted metal BI (RAL 9003 gloss) or mirror-finish glass SP frame. Side diffusers in frosted glass.	Applique. Structure en métal peint en blanc brillant BI (RAL 9003 brillante) ou miroir SP . Diffuseurs latéraux en verre satiné.	Wandleuchte. Gestell aus glänzend weiß lackiertem Metall BI (RAL 9003 glänzend) oder gespiegelt SP . Seitliche Diffusoren aus satiniertem Glas.	Lámpara de pared. Montura de metal pintado blanco brillante BI (RAL 9003 brillante) o espejado SP . Difusores laterales de vidriosatinado.
5525...	lampadine / bulbs / ampoules / Glühbirnen / bombillas	CE IP20 EREC ERAC D→E		
	1x40W (HA) G9 or 1x33W (HA) ES G9			

5600...	lampadine / bulbs / ampoules / Glühbirnen / bombillas	CE IP20 EREC ERAC A++ INCL. LED NOT REPLACEABLE		
	2 LED - 6W (3500 K, CRI>85, 640 Lm)			

Esterno / Outdoor / Extérieur
Außen / Exterior

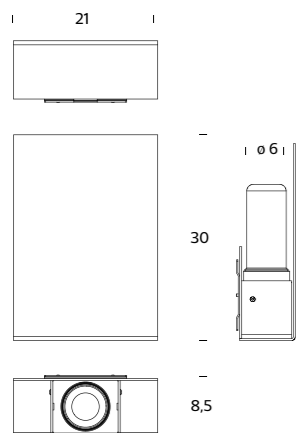

IT	EN	FR	DE	ES
Lampada da parete da esterno. Struttura in acciaio inox satinato. Diffusore in policarbonato opalino bianco. Schermo di protezione in vetro borosilicato trasparente. Emissione di luce diffusa verso l'alto oppure verso il basso a seconda dell'installazione.	Outdoor wall lamp. Frosted stainless steel frame. Opaline white polycarbonate diffuser. Transparent borosilicate glass shield. Installation for upward or downward soft light emission.	Applique d'extérieur. Structure en acier inox satiné. Diffuseur en polycarbonate opalin blanc. Écran de protection en verre borosilicate transparent. Émission de lumière diffusée vers le haut ou vers le bas en fonction de l'installation.	Wandleuchte für Außenbereich. Struktur aus satiniertem Edelstahl. Diffusor aus Polycarbonat opalweiß. Sicherheitsblende aus transparentem Borosilikatglas. Lichtausstrahlung je nach Montageart nach oben oder nach unten.	Lámpara de pared para exteriores. Estructura de acero inoxidable satinado. Difusor de policarbonato opalino blanco. Pantalla de protección de vidrio borosilicato transparente. Emisión luminosa difusa hacia arriba o hacia abajo, dependiendo de la instalación.
3929IX	lampadine / bulbs / ampoules / Glühbirnen / bombillas	CE IP54 EREC A		
	1x27W (FL) E27			

CUPOLA

pag. 118

Lampada a sospensione / Suspension lamp
Suspension / Pendelleuchte / Suspensión

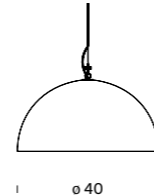

IT	EN	FR	DE	ES
Lampada a sospensione. Montatura in metallo verniciato color alluminio (RAL 9006 semi-matt) con interno bianco. Cavo di alimentazione trasparente.	Suspension lamp. Metal frame in aluminium finish (RAL 9006 semi-matt) with white interior. Transparent power cable.	Suspension. Structure en métal peint en couleur aluminium (RAL 9006 semi-matt) avec intérieur blanc. Câble d'alimentation transparent.	Hängeleuchte. Metallgestell, lackiert, aluminiumfarben (RAL 9006 semi-matt), innen weiß. Transparentes Netzkabel.	Lámpara de techo. Montura de metal pintado en color aluminio (RAL 9006 semi-matt) con interior blanco. Cable de alimentación transparente.
5117AN	lampadine / bulbs / ampoules / Glühbirnen / bombillas	CE IP20 EREC D→E		
	1x105W (HA) ES E27			

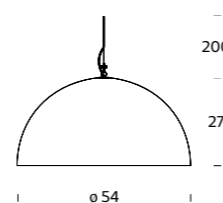

IT	EN	FR	DE	ES
Lampada a sospensione. Montatura in metallo verniciato color alluminio (RAL 9006 semi-matt) con interno bianco. Cavo di alimentazione trasparente.	Suspension lamp. Metal frame in aluminium finish (RAL 9006 semi-matt) with white interior. Transparent power cable.	Suspension. Structure en métal peint en couleur aluminium (RAL 9006 semi-matt) avec intérieur blanc. Câble d'alimentation transparent.	Hängeleuchte. Metallgestell, lackiert, aluminiumfarben (RAL 9006 semi-matt), innen weiß. Transparentes Netzkabel.	Lámpara de techo. Montura de metal pintado en color aluminio (RAL 9006 semi-matt) con interior blanco. Cable de alimentación transparente.
5117/1AN	lampadine / bulbs / ampoules / Glühbirnen / bombillas	CE IP20 EREC D→E		
	1x140W (HA) ES E27			

DARUMA

pag. 120



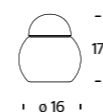



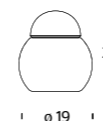

Lampada da tavolo / Table lamp / Lampe de table / Tischleuchte / Lámpara de sobremesa

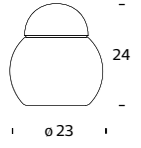









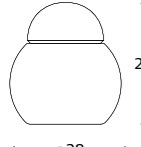







IT	EN	FR	DE	ES
Lampada da tavolo. Diffusore e coppetta in vetro soffiato bianco lucido. Cavo di alimentazione, interruttore e spina neri.	Table lamp. Diffuser and flute in polished white blown glass. Black power cable, plug and switch.	Lampe de table. Diffuseur et coupe en verre soufflé blanc poli. Câble d'alimentation, fiche et interrupteur noirs.	Tischleuchte. Diffusor und Schale aus glänzend weißem mundgeblasenem Glas. Netzkabel, Netzstecker und Schalter schwarz.	Lámpara de sobremesa. Difusor y copa de vidrio soplado blanco brillante. Cable de alimentación, enchufe e interruptor negros.
5028	lampadine / bulbs / ampoules / Glühbirnen / bombillas	CE IP20 EREC D→E		
	1x25W (IN) E27 or 1x18W (HA) ES E27			

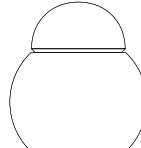







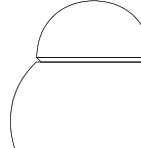

IT	EN	FR	DE	ES
Lampada da tavolo. Diffusore e coppetta in vetro soffiato bianco lucido. Cavo di alimentazione, interruttore e spina neri.	Table lamp. Diffuser and flute in polished white blown glass. Black power cable, plug and switch.	Lampe de table. Diffuseur et coupe en verre soufflé blanc poli. Câble d'alimentation, fiche et interrupteur noirs.	Tischleuchte. Diffusor und Schale aus glänzend weißem mundgeblasenem Glas. Netzkabel, Netzstecker und Schalter schwarz.	Lámpara de sobremesa. Difusor y copa de vidrio soplado blanco brillante. Cable de alimentación, enchufe e interruptor negros.
5028/1	lampadine / bulbs / ampoules / Glühbirnen / bombillas	CE IP20 EREC A→E		
	1x25W (IN) E27 or 1x18W (HA) ES E27 or 1x5W (FL) E27			

	IT	EN	FR	DE	ES	
	5028/2	Lampada da tavolo. Diffusore e coppetta in vetro soffiato bianco lucido. Cavo di alimentazione, interruttore e spina neri.	Table lamp. Diffuser and flute in polished white blown glass. Black power cable, plug and switch.	Lampe de table. Diffuseur et coupe en verre soufflé blanc poli. Câble d'alimentation, fiche et interrupteur noirs.	Tischleuchte. Diffusor und Schale aus glänzend weißem mundgeblasenem Glas. Netzkabel, Netzstecker und Schalter schwarz.	Lámpara de sobremesa. Difusor y copa de vidrio soplado blanco brillante. Cable de alimentación, enchufe e interruptor negros.
	<p>lampadine / bulbs / ampoules / Glühbirnen / bombillas</p> <p>  1x40W (IN) E27 or  1x28W (HA)  E27 or  1x12W (FL) E27 </p>	 IP20   				









	5028/3	Lampada da tavolo. Diffusore e coppetta in vetro soffiato bianco lucido. Cavo di alimentazione, interruttore e spina neri.	Table lamp. Diffuser and flute in polished white blown glass. Black power cable, plug and switch.	Lampe de table. Diffuseur et coupe en verre soufflé blanc poli. Câble d'alimentation, fiche et interrupteur noirs.	Tischleuchte. Diffusor und Schale aus glänzend weißem mundgeblasenem Glas. Netzkabel, Netzstecker und Schalter schwarz.	Lámpara de sobremesa. Difusor y copa de vidrio soplado blanco brillante. Cable de alimentación, enchufe e interruptor negros.
	<p>lampadine / bulbs / ampoules / Glühbirnen / bombillas</p> <p>  1x60W (IN) E27 or  1x42W (HA)  E27 or  1x12W (FL) E27 </p>	 IP20   				

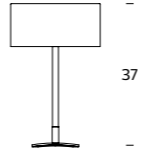





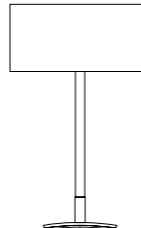

	5028/4	Lampada da tavolo. Diffusore e coppetta in vetro soffiato bianco lucido. Cavo di alimentazione, interruttore e spina neri.	Table lamp. Diffuser and flute in polished white blown glass. Black power cable, plug and switch.	Lampe de table. Diffuseur et coupe en verre soufflé blanc poli. Câble d'alimentation, fiche et interrupteur noirs.	Tischleuchte. Diffusor und Schale aus glänzend weißem mundgeblasenem Glas. Netzkabel, Netzstecker und Schalter schwarz.	Lámpara de sobremesa. Difusor y copa de vidrio soplado blanco brillante. Cable de alimentación, enchufe e interruptor negros.
	<p>lampadine / bulbs / ampoules / Glühbirnen / bombillas</p> <p>  1x75W (IN) E27 or  1x70W (HA)  E27 or  1x20W (FL) E27 </p>	 IP20   				

	5028/5	Lampada da tavolo. Diffusore e coppetta in vetro soffiato bianco lucido. Cavo di alimentazione, interruttore e spina neri.	Table lamp. Diffuser and flute in polished white blown glass. Black power cable, plug and switch.	Lampe de table. Diffuseur et coupe en verre soufflé blanc poli. Câble d'alimentation, fiche et interrupteur noirs.	Tischleuchte. Diffusor und Schale aus glänzend weißem mundgeblasenem Glas. Netzkabel, Netzstecker und Schalter schwarz.	Lámpara de sobremesa. Difusor y copa de vidrio soplado blanco brillante. Cable de alimentación, enchufe e interruptor negros.
	<p>lampadine / bulbs / ampoules / Glühbirnen / bombillas</p> <p>  1x75W (IN) E27 or  1x100W (HA)  E27 </p>	 IP20   				

DRUM







pag. 122

	IT	EN	FR	DE	ES	
	3682/00	Lampada da tavolo con dimmer. Diffusore in vetro soffiato bianco acidato. Base in acciaio lucido con stelo in vetro borosilicato trasparente. Cavo di alimentazione, dimmer e spina trasparenti.	Table lamp with dimmer. Diffuser in acid-etched white blown glass. Polished steel base with transparent borosilicate glass stem. Transparent power cable, dimmer and plug.	Lampe de table avec variateur. Diffuseur en verre soufflé blanc dépoli. Base en acier poli, tige en verre borosilicate transparent. Câble d'alimentation, variateur et fiche transparents.	Tischleuchte mit Dimmer. Diffusor aus weißem mundgeblasenem und geätzt Glas. Fuß aus Glanzstahl mit Stab aus Borosilikatglas. Netzkabel, Dimmer und Netzstecker transparent.	Lámpara de sobremesa con dimmer. Difusor de vidrio soplado blanco tratado al ácido. Base de acero brillante con pie de vidrio borosilicato transparente. Cable de alimentación, dimmer y enchufe transparentes.
	<p>lampadine / bulbs / ampoules / Glühbirnen / bombillas</p> <p>  3x25W (HA) G9 or  3x20W (HA)  G9 </p>	 IP20   				

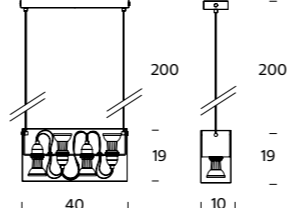
	3682/0	Lampada da tavolo con dimmer. Diffusore in vetro soffiato bianco acidato. Base in acciaio lucido con stelo in vetro borosilicato trasparente. Cavo di alimentazione, dimmer e spina trasparenti.	Table lamp with dimmer. Diffuser in acid-etched white blown glass. Polished steel base with transparent borosilicate glass stem. Transparent power cable, dimmer and plug.	Lampe de table avec variateur. Diffuseur en verre soufflé blanc dépoli. Base en acier poli, tige en verre borosilicate transparent. Câble d'alimentation, variateur et fiche transparents.	Tischleuchte mit Dimmer. Diffusor aus weißem mundgeblasenem und geätzt Glas. Fuß aus Glanzstahl mit Stab aus Borosilikatglas. Netzkabel, Dimmer und Netzstecker transparent.	Lámpara de sobremesa con dimmer. Difusor de vidrio soplado blanco tratado al ácido. Base de acero brillante con pie de vidrio borosilicato transparente. Cable de alimentación, dimmer y enchufe transparentes.
	<p>lampadine / bulbs / ampoules / Glühbirnen / bombillas</p> <p>  3x40W (HA) G9 or  3x33W (HA)  G9 </p>	 IP20   				

DUPLEX

pag. 124

	IT	EN	FR	DE	ES	
	5306/1...	Lampada a sospensione. Diffusore in metacrilato colorato, colorato rosso R o satinato SA . Canalina in acciaio lucidato. Portalampade regolabili per una diffusione diretta o indiretta della luce.	Suspension lamp. Cast methacrylate diffuser in red R or frosted SA finish. Polished steel raceway. Adjustable lamp holders for direct or indirect beam.	Suspension. Diffuseur en méthacrylate coulé, de couleur rouge R ou satiné SA . Goulotte en acier poli. Douilles réglables pour une diffusion directe ou indirecte de la lumière.	Hängeleuchte. Gegossener Methacrylat-Diffusor, rot gefärbt R oder satiniert SA . Kanal aus poliertem Stahl. Regulierbare Lampenfassungen zur direkten oder indirekten Lichtverteilung.	Lámpara de techo. Difusor de metacrilato moldeado, de color rojo R o satinado SA . Canal de cables de acero bruñido. Portabombillas regulables para permitir la difusión directa o indirecta de la luz.
	<p>lampadine / bulbs / ampoules / Glühbirnen / bombillas</p> <p>  4x50W (HA)  E27 </p>	 IP20   				

FALENA

pag. 126

Lampada da tavolo / Table lamp / Lampe de table / Tischleuchte / Lámpara de sobremesa

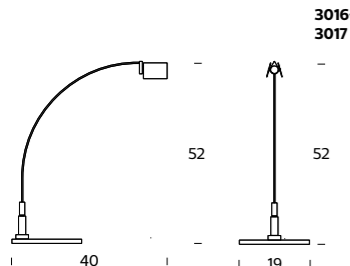
IT	EN	FR	DE	ES	
 <p>3016+ 3017</p>	<p>Lampada da tavolo a bassa tensione con trasformatore elettronico a spina e interruttore sul cavo per doppia intensità luminosa. Base in vetro float molato. Corpo orientabile di 360° sul piano orizzontale in metallo cromato. Alette diffusori orientabili in alluminio anodizzato. Il collegamento elettrico fra la base e il corpo avviene tramite jack. Cavo di alimentazione, interruttore e spina neri.</p> <p>3016 corpo 3017 base</p>	<p>Low-voltage table lamp with electronic plug-in transformer and cable switch for dual light intensity. Base in cut float glass. Chromed metal body with 360° horizontal rotation. Pivoting anodized aluminium diffuser fins. Jack connection from base to body. Black power cable, plug and switch.</p> <p>3016 body 3017 base</p>	<p>Lampe de table à basse tension avec transformateur électronique à fiche et interrupteur à double intensité lumineuse sur le câble. Base en verre flotté biseauté. Corps orientable à 360° sur le plan horizontal en métal chromé. Diffuseurs à ailettes orientables en aluminium anodisé. La connexion électrique entre la base et le corps est assurée par une douille-jack. Câble d'alimentation, interrupteur et interrupteur noirs.</p> <p>3016 corps 3017 base</p>	<p>Tischleuchte für Niederspannung mit elektronischem Trafo mit Stecker und Schalter auf dem Kabel für doppelte Lichtintensität. Fuß aus geschliffenem Float-Glas. Auf waagerechter Ebene um 360° drehbarer Lampenkörper aus verchromtem Metall. Verstellbare Flügel-Schirme aus eloxiertem Aluminium. Die elektrische Verbindung zwischen Fuß und Körper erfolgt durch Einschaltklinke. Netzkabel, Netzstecker und Schalter schwarz.</p> <p>3016 Körper 3017 Fuß</p>	<p>Lámpara de sobremesa de baja tensión con transformador electrónico con enchufe e interruptor en el cable para doble intensidad luminosa. Base de vidrio float desbastado. El cuerpo de metal cromado gira 360° sobre el plano horizontal. Aletas difusoras orientables de aluminio anodizado. La conexión eléctrica entre la base y el cuerpo se produce mediante jack. Cable de alimentación, enchufe e interruptor negros.</p> <p>3016 cuerpo 3017 base</p>

lampadine / bulbs / ampoules / Glühbirnen / bombillas



- ⇒ 1x50W (HA) GY6.35 12V or
- ⇒ 1x35W (HA) Ⓞ GY6.35 12V

Lampada da parete / Wall lamp / Applique / Wandleuchte / Aplique

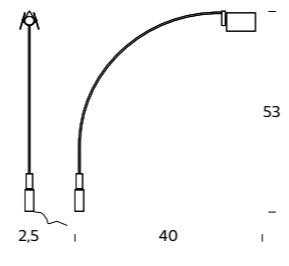
IT	EN	FR	DE	ES
 <p>3016+ 3019</p>	<p>Low-voltage wall lamp with electronic plug-in transformer and cable switch for dual light intensity. Adjustable chromed metal body. Pivoting anodized aluminium diffuser fins. Chrome-plated brass wall support. Jack connection from base to body.</p> <p>3016 body 3019 support</p>	<p>Applique à basse tension, avec transformateur électronique à fiche et interrupteur à double intensité sur le câble. Corps orientable en métal chromé. Diffuseurs à ailettes orientables, en aluminium anodisé. Support en laiton chromé. La connexion électrique entre le support et le corps est assurée par le biais d'une douille-jack.</p> <p>3016 corps 3019 support</p>	<p>Niederspannungs-Wandleuchte mit elektronischem Trafo mit Stecker und Schalter am Kabel für doppelte Intensität. Verstellbarer Körper aus verchromtem Metall. Diffusor-Flügel aus eloxiertem Aluminium. Ständer aus verchromtem Messing. Elektrische Verbindung zwischen Basis und Körper durch Anschaltklinke.</p> <p>3016 Körper 3019 Ständer</p>	<p>Lámpara de pared de baja tensión con transformador electrónico con enchufe e interruptor en el cable para doble intensidad. Cuerpo orientable de metal cromado. Aletas difusoras orientables de aluminio anodizado. Soporte de latón cromado. La conexión eléctrica entre la base y el cuerpo se produce mediante jack.</p> <p>3016 cuerpo 3019 soporte</p>

lampadine / bulbs / ampoules / Glühbirnen / bombillas



- ⇒ 1x50W (HA) GY6.35 12V or
- ⇒ 1x35W (HA) Ⓞ GY6.35 12V

Lampada da terra / Floor lamp / Lampadaire Stehleuchte / Lámpara de pie

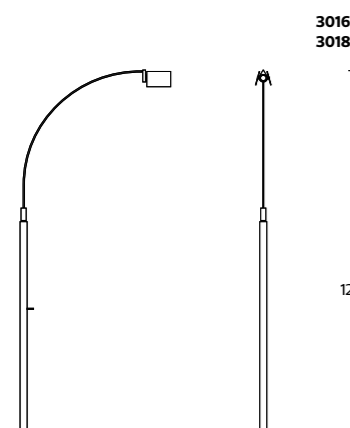
IT	EN	FR	DE	ES
 <p>3016+ 3018</p>	<p>Lampada da terra a bassa tensione, con trasformatore elettronico e dimmer posizionati sul cavo. Corpo in metallo cromato. Alette diffusori, orientabili, in alluminio anodizzato. Stelo in metallo cromato con base in vetro float molato. Il collegamento elettrico fra lo stelo e il corpo avviene tramite jack. Cavo di alimentazione, dimmer o interruttore e spina neri.</p> <p>3016 corpo 3018 base e stelo</p>	<p>Low-voltage floor lamp with electronic transformer and dimmer on cable. Chromed metal body. Pivoting anodized aluminium diffuser fins. Chromed metal stem with cut float glass base. Jack connection from base to body. Black power cable, dimmer and switch.</p> <p>3016 body 3018 base and stem</p>	<p>Niederspannungs-Stehlampe mit elektronischem Trafo und Dimmer am Kabel befestigt. Körper aus verchromtem Metall. Orientierbare Flügel-Reflektoren aus eloxiertem Aluminium. Stiel aus verchromtem Messing mit Basis aus transparentem, geschliffenem Glas. Elektrische Verbindung zwischen Körper und Stiel durch Anschaltklinke. Netzkabel, Dimmer und Schalter schwarz.</p> <p>3016 Körper 3018 Basis und Stiel</p>	<p>Lámpara de pie de baja tensión, con transformador electrónico y dimer incorporados en el cable. Cuerpo de metal cromado. Aletas difusoras orientables, de aluminio anodizado. Pie de metal cromado con base de vidrio float desbastado. La conexión eléctrica entre el pie y el cuerpo se produce mediante jack. Cable de alimentación, dimer e interruptor negros.</p> <p>3016 cuerpo 3018 base y pie</p>

lampadine / bulbs / ampoules / Glühbirnen / bombillas



- ⇒ 1x50W (HA) GY6.35 12V or
- ⇒ 1x35W (HA) Ⓞ GY6.35 12V

FLEX

pag. 132

Lampada da parete / Wall lamp / Applique Wandleuchte / Aplique

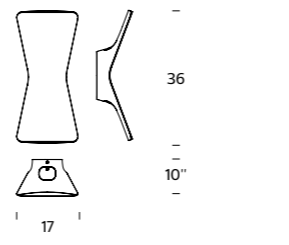
IT	EN	FR	DE	ES
 <p>4310..</p>	<p>Wall lamp. Body in die-cast aluminium, painted white BI, black N, pink RS or blue BL, nero N, rosa RS oppure blu BL, opaco. Doppia emissione luminosa.</p>	<p>Applique. Corps en aluminium moulé, peint blanc BI, noir N, rose RS ou bleu BL, mat. Double émission de lumière.</p>	<p>Wandleuchte. Gestell aus druckgegossenem Aluminium, erhältlich weiß BI, schwarz N, rosa RS oder blau BL, matte. Doppellichtemission.</p>	<p>Lámpara de pared. Cuerpo de aluminio moldeado. Pintado blanco BI, negro N, rosa RS o azul BL, mate. Emisión de luz doble.</p>

lampadine / bulbs / ampoules / Glühbirnen / bombillas



- 2 LED - 13W (3000 K, CRI>80, 1350 Lm + 1350 Lm)

FLÛTE, FLÛTE MAGNUM

pag. 134

Lampada da terra / Floor lamp / Lampadaire / Stehleuchte / Lámpara de pie

IT	EN	FR	DE	ES	
3300	Lampada da terra con dimmer. Stelo in vetro borosilicato trasparente. Riflettore in alluminio cromato lucido. Base e supporto riflettore in metallo cromato. Cavo di alimentazione e dimmer trasparenti.	Floor lamp with dimmer. Transparent borosilicate glass stem. Polished chromed aluminium reflector. Base and reflector support in chromed metal. Transparent power cable and dimmer.	Lampadaire avec variateur. Tige en verre borosilicate transparent. Réflecteur en aluminium chromé poli. Base et support du réflecteur en métal chromé. Câble d'alimentation et variateur transparent.	Stehleuchte mit Dimmer. Stiel aus transparentem Borosilikatglas. Reflektor aus verchromtem glänzendem Aluminium. Basis und Reflektorstütze aus verchromtem Metall. Netzkabel und Dimmer transparent.	Lámpara de pie con dimer. Pie de vidrio borosilicato transparente. Reflector de aluminio cromado brillante. Base y soporte para reflector de metal cromado. Cable de alimentación y dimer transparentes.



lampadine / bulbs / ampoules / Glühbirnen / bombillas



1x205W (HA) E27

IT	EN	FR	DE	ES	
3300/1 (MAGNUM)	Lampada da terra con dimmer. Stelo in vetro borosilicato trasparente. Riflettore in alluminio cromato lucido. Base e supporto riflettore in metallo cromato. Cavo di alimentazione e dimmer trasparenti.	Floor lamp with dimmer. Transparent borosilicate glass stem. Polished chromed aluminium reflector. Base and reflector support in chromed metal. Transparent power cable and dimmer.	Lampadaire avec variateur. Tige en verre borosilicate transparent. Réflecteur en aluminium chromé poli. Base et support du réflecteur en métal chromé. Câble d'alimentation et variateur transparent.	Stehleuchte mit Dimmer. Stiel aus transparentem Borosilikatglas. Reflektor aus verchromtem glänzendem Aluminium. Basis und Reflektorstütze aus verchromtem Metall. Netzkabel und Dimmer transparent.	Lámpara de pie con dimer. Pie de vidrio borosilicato transparente. Reflector de aluminio cromado brillante. Base y soporte para reflector de metal cromado. Cable de alimentación y dimer transparentes.



lampadine / bulbs / ampoules / Glühbirnen / bombillas



1x400W (HA) E27 R7s/115

Lampada da parete / Wall lamp / Applique / Wandleuchte / Aplique

IT	EN	FR	DE	ES	
3314	Lampada da parete. Corpo in vetro borosilicato trasparente. Riflettore in alluminio cromato lucido. Supporto in metallo cromato.	Wall lamp. Transparent borosilicate glass body. Reflector in polished chromed aluminium. Chromed metal support.	Applique. Corps en verre borosilicate transparent. Réflecteur en aluminium chromé brillant. Support en métal chromé.	Wandleuchte. Körper aus transparentem Borosilikat-glas. Reflektor aus glänzend verchromtem Aluminium. Gestell aus verchromtem Metall.	Lámpara de pared. Cuerpo de vidrio borosilicato transparente. Reflector de aluminio cromado brillante. Soporte de metal cromado.

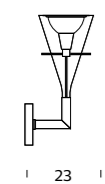
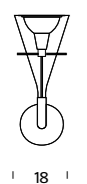

lampadine / bulbs / ampoules / Glühbirnen / bombillas



1x205W (HA) E27

Lampada a sospensione / Suspension lamp / Suspension / Pendelleuchte / Suspensión

IT	EN	FR	DE	ES	
3337	Lampada a sospensione. Diffusore in vetro borosilicato trasparente. Riflettore in alluminio cromato lucido. Cavo di alimentazione trasparente. Il cono di vetro accoglie al suo interno il riflettore sorretto da tre bracci cromati. La luce si riflette all'interno del cono e si diffonde in modo uniforme verso il basso.	Suspension lamp. Transparent borosilicate glass diffuser. Reflector in polished chromed aluminium. Transparent power cable. Glass cone houses a reflector held by three chromed arms. The light reflects around the cone thus giving constant downward emission.	Suspension. Diffuseur en verre borosilicate transparent. Réflecteur en aluminium chromé poli. Câble d'alimentation transparent. Le cône de verre abrite à l'intérieur le réflecteur soutenu par trois tiges chromées. La lumière se reflète à l'intérieur du cône et se diffuse de manière uniforme vers le bas.	Hängeleuchte. Diffusor aus transparentem Borosilikatglas. Reflektor aus verchromtem glänzendem Aluminium. Transparentes Netzkabel. Der Glaskegel enthält in seinem Innern den Reflektor, der von drei verchromten Armen gehalten wird. Das Licht spiegelt sich im Innern des Kegels wider und verteilt sich gleichmäßig nach unten.	Lámpara de techo. Difusor de vidrio borosilicato transparente. Reflector de aluminio cromado brillante. Cable de alimentación transparente. El cono de vidrio aloja en su interior el reflector sujetado por tres brazos cromados. La luz se refleja en el interior del cono y se difunde de modo uniforme hacia abajo.



lampadine / bulbs / ampoules / Glühbirnen / bombillas



1x70W (HA) E27

IT	EN	FR	DE	ES
4342	lampadine / bulbs / ampoules / Glühbirnen / bombillas	lampadine / bulbs / ampoules / Glühbirnen / bombillas	lampadine / bulbs / ampoules / Glühbirnen / bombillas	lampadine / bulbs / ampoules / Glühbirnen / bombillas

1 LED - 10W LINE VOLTAGE (2700 K, CRI 80, 1250 Lm)

Lampada a sospensione / Suspension lamp / Suspension / Pendelleuchte / Suspensión

IT	EN	FR	DE	ES	
3337/1 (MAGNUM)	Lampada a sospensione. Diffusore in vetro borosilicato trasparente. Riflettore in alluminio cromato lucido. Cavo di alimentazione trasparente. Il cono di vetro accoglie al suo interno il riflettore sorretto da tre bracci cromati. La luce si riflette all'interno del cono e si diffonde in modo uniforme verso il basso.	Suspension lamp. Transparent borosilicate glass diffuser. Reflector in polished chromed aluminium. Transparent power cable. Glass cone houses a reflector held by three chromed arms. The light reflects around the cone thus giving constant downward emission.	Suspension. Diffuseur en verre borosilicate transparent. Réflecteur en aluminium chromé poli. Câble d'alimentation transparent. Le cône de verre abrite à l'intérieur le réflecteur soutenu par trois tiges chromées. La lumière se reflète à l'intérieur du cône et se diffuse de manière uniforme vers le bas.	Hängeleuchte. Diffusor aus transparentem Borosilikatglas. Reflektor aus verchromtem glänzendem Aluminium. Transparentes Netzkabel. Der Glaskegel enthält in seinem Innern den Reflektor, der von drei verchromten Armen gehalten wird. Das Licht spiegelt sich im Innern des Kegels wider und verteilt sich gleichmäßig nach unten.	Lámpara de techo. Difusor de vidrio borosilicato transparente. Reflector de aluminio cromado brillante. Cable de alimentación transparente. El cono de vidrio aloja en su interior el reflector sujetado por tres brazos cromados. La luz se refleja en el interior del cono y se difunde de modo uniforme hacia abajo.

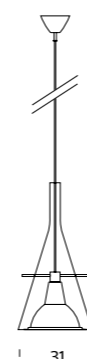

lampadine / bulbs / ampoules / Glühbirnen / bombillas

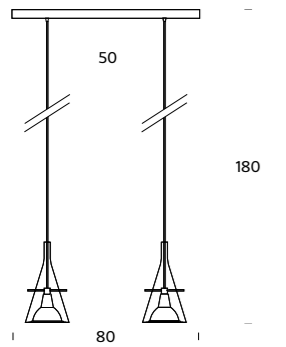
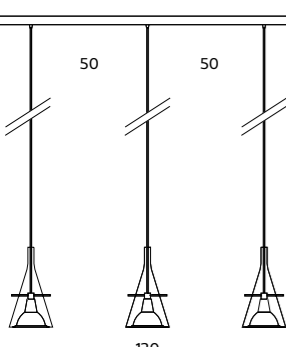

1x230W (HA) E27 R7s/115

	IT	EN	FR	DE	ES
	Lampada a sospensione provvista di due luci montate su canalina con interasse 50 cm. Diffusori in vetro borosilicato trasparente. Riflettori in alluminio cromato lucido. Cavo di alimentazione trasparente.	Suspension lamp with 2 lights mounted on a raceway with 50 cm between centres. Transparent borosilicate glass diffusers. Polished chromed aluminium reflectors. Transparent power cable.	Suspension pourvue de deux lampes montées sur une goulotte avec entraxe de 50 cm. Diffuseurs en verre borosilicate transparent. Réflecteurs en aluminium chromé brillant. Câble d'alimentation transparent.	Hängeleuchte, die über zwei Lampen verfügt, die auf einer Führungsschiene mit Achsabstand von 50 cm montiert sind. Diffusoren aus Borosilikatglas. Reflektoren aus verchromtem, glänzendem Aluminium. Transparentes Netzkabel.	Lámpara de techo provista de dos luces montadas en un riel con distancia entre centros 50 cm. Difusores de vidrio borosilicato transparente. Reflectores de aluminio cromado brillante. Cable de alimentación transparente.
	3337/2	lampadine / bulbs / ampoules / Glühbirnen / bombillas	CE IP20 Intertek ENE INCL. D	INCL. D	
		2x70W (HA) E27			
	4342/2	lampadine / bulbs / ampoules / Glühbirnen / bombillas	CE IP20 ENE INCL. LED NOT REPLACEABLE		
		2 LED - 10W LINE VOLTAGE (2700 K, CRI 80, 1250 Lm + 1250 Lm)			
	Lampada a sospensione provvista di tre luci montate su canalina con interasse 50 cm. Diffusori in vetro borosilicato trasparente. Riflettori in alluminio cromato lucido. Cavo di alimentazione trasparente.	Suspension lamp with 3 lights mounted on a raceway with 50 cm between centres. Transparent borosilicate glass diffusers. Polished chromed aluminium reflectors. Transparent power cable.	Suspension pourvue de trois lampes montées sur une goulotte avec entraxe de 50 cm. Diffuseurs en verre borosilicate transparent. Réflecteurs en aluminium chromé brillant. Câble d'alimentation transparent.	Hängeleuchte, die über drei Lampen verfügt, die auf einer Führungsschiene mit Achsabstand von 50 cm montiert sind. Diffusoren aus Borosilikatglas. Reflektoren aus verchromtem, glänzendem Aluminium. Transparentes Netzkabel.	Lámpara de techo provista de tres luces montadas en un riel con distancia entre centros 50 cm. Difusores de vidrio borosilicato transparente. Reflectores de aluminio cromado brillante. Cable de alimentación transparente.
	3337/3	lampadine / bulbs / ampoules / Glühbirnen / bombillas	CE IP20 Intertek ENE INCL. D	INCL. D	
		3x70W (HA) E27			
	4342/3	lampadine / bulbs / ampoules / Glühbirnen / bombillas	CE IP20 ENE INCL. LED NOT REPLACEABLE		
		3 LED - 10W LINE VOLTAGE (2700 K, CRI 80, 1250 Lm + 1250 Lm + 1250 Lm)			

Lampada da tavolo / Table lamp / Lampe de table / Tischleuchte / Lámpara de sobremesa





	IT	EN	FR	DE	ES
	1853/0	Lampada da tavolo a doppia accensione. Montatura in metallo verniciato bianco. Paralume e base in vetro soffiato bianco satinato. Cavo di alimentazione, interruttore e spina neri.	Table lamp with dual controls. Metal frame with white finish. Shade and base in frosted white blown glass. Black power cable, plug and switch.	Lampe de table à double allumage. Structure en métal peint en blanc. Abat-jour et base en verre soufflé blanc satiné. Câble d'alimentation, fiche et interrupteur noirs.	Tischleuchte mit Doppel-Schaltung. Gestell aus weiß lackiertem Metall. Lampenschirm und Fuß aus weißem, mundgeblasenem satiniertem Glas. Netzkabel, Netzstecker und Schalter schwarz.
		1x60W (IN) E27 or 1x16W (FL) E27 + 2x25W (HA) G9 or 2x20W (HA) G9			
		CE IP20 Classe II INCL. D			
	1853	Lampada da tavolo a doppia accensione. Montatura in metallo verniciato bianco. Paralume e base in vetro soffiato bianco satinato. Cavo di alimentazione, interruttore e spina neri.	Table lamp with dual controls. Metal frame with white finish. Shade and base in frosted white blown glass. Black power cable, plug and switch.	Lampe de table à double allumage. Structure en métal peint en blanc. Abat-jour et base en verre soufflé blanc satiné. Câble d'alimentation, fiche et interrupteur noirs.	Tischleuchte mit Doppel-Schaltung. Gestell aus weiß lackiertem Metall. Lampenschirm und Fuß aus weißem, mundgeblasenem satiniertem Glas. Netzkabel, Netzstecker und Schalter schwarz.
		1x100W (HA) E27 or 1x20W (FL) E27 + 2x40W (IN) E14			
		CE IP20 Classe II Intertek INCL. F			
	1853/1	Lampada da tavolo a tripla accensione. Montatura in metallo verniciato bianco. Paralume e base in vetro soffiato bianco satinato. Cavo di alimentazione, interruttore e spina neri.	Table lamp with triple controls. Metal frame with white finish. Shade and base in frosted white blown glass. Black power cable, plug and switch.	Lampe de table à triple allumage. Structure en métal peint en blanc. Abat-jour et base en verre soufflé blanc satiné. Câble d'alimentation, fiche et interrupteur noirs.	Tischleuchte mit Dreifach-Schaltung. Gestell aus weiß lackiertem Metall. Lampenschirm und Fuß aus weißem, mundgeblasenem satiniertem Glas. Netzkabel, Netzstecker und Schalter schwarz.
		4x60W (IN) E27 or 4x20W (FL) E27 + 1x100W (HA) E27 + 2x40W (IN) E14			
		CE IP20 Classe II INCL. F			

FONTANA TOTAL BLACK









pag. 146

Lampada da tavolo / Table lamp / Lampe de table / Tischleuchte / Lámpara de sobremesa

IT	EN	FR	DE	ES	
	1853/ON Lampada da tavolo a doppia accensione. Montatura in metallo verniciato nero. Paralume e base in vetro soffiato nero. Cavo di alimentazione, interruttore e spina neri.	Table lamp with dual controls. Metal frame with black finish. Shade and base in black blown glass. Black power cable, plug and switch.	Lampe de table à double allumage. Structure en métal peint en noir. Abat-jour et base en verre soufflé noir. Câble d'alimentation, fiche et interrupteur noirs.	Tischleuchte mit Doppel-Schaltung. Gestell aus schwarz lackiertem Metall. Lampenschirm und Fuß aus schwarzem, mundgeblasenem Glas. Netzkabel, Netzstecker und Schalter schwarz.	Lámpara de sobremesa de encendido doble. Montura de metal pintado negro. Pantalla y base de vidrio soplado negro. Cable de alimentación, enchufe e interruptor negros.

 IP20    INCL. D
 1x46W (HA)  E27
 + 2x20W (HA)  E27 G9

	1853/N Lampada da tavolo a doppia accensione. Montatura in metallo verniciato nero. Paralume e base in vetro soffiato nero. Cavo di alimentazione, interruttore e spina neri.	Table lamp with dual controls. Metal frame with black finish. Shade and base in black blown glass. Black power cable, plug and switch.	Lampe de table à double allumage. Structure en métal peint en noir. Abat-jour et base en verre soufflé noir. Câble d'alimentation, fiche et interrupteur noirs.	Tischleuchte mit Doppel-Schaltung. Gestell aus schwarz lackiertem Metall. Lampenschirm und Fuß aus schwarzem, mundgeblasenem Glas. Netzkabel, Netzstecker und Schalter schwarz.	Lámpara de sobremesa de encendido doble. Montura de metal pintado negro. Pantalla y base de vidrio soplado negro. Cable de alimentación, enchufe e interruptor negros.
----------------------------------------------------------------------------------	-----------------------------------------------------------------------------------------------------------------------------------------------------------------------------------------	----------------------------------------------------------------------------------------------------------------------------------------	-----------------------------------------------------------------------------------------------------------------------------------------------------------------	---------------------------------------------------------------------------------------------------------------------------------------------------------------------------------	------------------------------------------------------------------------------------------------------------------------------------------------------------------------

 IP20    INCL. D
 1x100W (HA)  E27
 + 2x30W (HA)  E14

	1853/1N Lampada da tavolo a tripla accensione. Montatura in metallo verniciato nero. Paralume e base in vetro soffiato nero. Cavo di alimentazione, interruttore e spina neri.	Table lamp with triple controls. Metal frame with black finish. Shade and base in black blown glass. Black power cable, plug and switch.	Lampe de table à triple allumage. Structure en métal peint en noir. Abat-jour et base en verre soufflé noir. Câble d'alimentation, fiche et interrupteur noirs.	Tischleuchte mit Dreifach-Schaltung. Gestell aus schwarz lackiertem Metall. Lampenschirm und Fuß aus schwarzem, mundgeblasenem Glas. Netzkabel, Netzstecker und Schalter schwarz.	Lámpara de sobremesa de encendido triple. Montura de metal pintado negro. Pantalla y base de vidrio soplado negro. Cable de alimentación, enchufe e interruptor negros.
-----------------------------------------------------------------------------------	------------------------------------------------------------------------------------------------------------------------------------------------------------------------------------------	------------------------------------------------------------------------------------------------------------------------------------------	-----------------------------------------------------------------------------------------------------------------------------------------------------------------	-----------------------------------------------------------------------------------------------------------------------------------------------------------------------------------	-------------------------------------------------------------------------------------------------------------------------------------------------------------------------

 IP20    INCL. D
 1x100W (HA)  E27
 + 4x46W (HA)  E27
 + 2x30W (HA)  E14





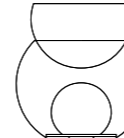

47

GIOVA

pag. 150

Lampada da tavolo / Table lamp / Lampe de table / Tischleuchte / Lámpara de sobremesa

IT	EN	FR	DE	ES	
	2684 Lampada/portafiori da tavolo. Base in metallo cromato. Sfera centrale in vetro trasparente soffiato. Sfera interna in vetro bianco opalino lucido. Semisfera superiore in vetro soffiato rosa con bollicine decorative. Cavo di alimentazione, interruttore e spina neri.	Table lamp/flower pot. Chromed metal base. Middle globe in transparent blown glass. Inner globe in polished white opaline glass. Upper half-sphere in pink blown glass with decorative bubbles. Black power cable, plug and switch.	Lampe de table/ porte- fleurs. Base en métal chromé. Sphère centrale en verre transparent soufflé. Sphère interne en verre blanc opalin poli. Demi-sphère supérieure en verre soufflé rose avec bulles décoratives. Câble d'alimentation, fiche et interrupteur noirs.	Tischleuchte/Blumenvase. Sockel aus verchromtem Metall. Mittlere Kugel aus transparentem, mundgeblasenem Glas. Innere Kugel aus glänzend weißem Opalglas. Obere Halbkugel aus mundgeblasenem rosafarbenem Glas mit dekorativen Bläschen. Netzkabel, Netzstecker und Schalter schwarz.	Lámpara/florero de sobremesa. Base de metal cromado. Esfera central de vidrio transparente soplado. Esfera interna de vidrio blanco opalino brillante. Semiesfera superior de vidrio soplado rosa con burbujas decorativas. Cable de alimentación, enchufe e interruptor negros.

 IP20    INCL. D
 1x60W (IN) E27 or
 1x42W (HA)  E27

	2684/1 Lampada/portafiori da tavolo. Base in metallo cromato. Sfera centrale in vetro trasparente soffiato. Sfera interna in vetro bianco opalino lucido. Semisfera superiore in vetro soffiato rosa con bollicine decorative. Cavo di alimentazione, interruttore e spina neri.	Table lamp/flower pot. Chromed metal base. Middle globe in transparent blown glass. Inner globe in polished white opaline glass. Upper half-sphere in pink blown glass with decorative bubbles. Black power cable, plug and switch.	Lampe de table/ porte- fleurs. Base en métal chromé. Sphère centrale en verre transparent soufflé. Sphère interne en verre blanc opalin poli. Demi-sphère supérieure en verre soufflé rose avec bulles décoratives. Câble d'alimentation, fiche et interrupteur noirs.	Tischleuchte/Blumenvase. Sockel aus verchromtem Metall. Mittlere Kugel aus transparentem, mundgeblasenem Glas. Innere Kugel aus glänzend weißem Opalglas. Obere Halbkugel aus mundgeblasenem rosafarbenem Glas mit dekorativen Bläschen. Netzkabel, Netzstecker und Schalter schwarz.	Lámpara/florero de sobremesa. Base de metal cromado. Esfera central de vidrio transparente soplado. Esfera interna de vidrio blanco opalino brillante. Semiesfera superior de vidrio soplado rosa con burbujas decorativas. Cable de alimentación, enchufe e interruptor negros.
-------------------------------------------------------------------------------------	--------------------------------------------------------------------------------------------------------------------------------------------------------------------------------------------------------------------------------------------------------------------------------------------	-------------------------------------------------------------------------------------------------------------------------------------------------------------------------------------------------------------------------------------	------------------------------------------------------------------------------------------------------------------------------------------------------------------------------------------------------------------------------------------------------------------------	---------------------------------------------------------------------------------------------------------------------------------------------------------------------------------------------------------------------------------------------------------------------------------------	----------------------------------------------------------------------------------------------------------------------------------------------------------------------------------------------------------------------------------------------------------------------------------



 IP20    INCL. D
 1x100W (HA)  E27

GLOBO DI LUCE

pag. 154

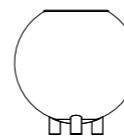
Lampada da tavolo / Table lamp / Lampe de table / Tischleuchte / Lámpara de sobremesa

IT	EN	FR	DE	ES	
	3667/1 Lampada da tavolo con dimmer. Globo in vetro soffiato metallizzato. Base in metallo cromato. Riflettore interno in alluminio anodizzato. Cavo di alimentazione, dimmer e spina trasparenti.	Table lamp with dimmer. Metallic blown glass bowl. Chromed metal base. Anodized aluminium internal reflector. Transparent power cable, dimmer and plug.	Lampe de table avec variateur. Globe en verre soufflé métallisé. Base en métal chromé. Réflecteur interne en aluminium anodisé. Câble d'alimentation, variateur et fiche transparents.	Tischleuchte mit Dimmer. Kugel aus mundgeblasenem, metallisiertem Glas. Sockel aus verchromtem Metall. Innenreflektor aus eloxiertem Aluminium. Netzkabel, Dimmer und Netzstecker transparent.	Lámpara de sobremesa con dimer. Globo de vidrio soplado metalizado. Base de metal cromado. Reflector interno de aluminio anodizado. Cable de alimentación, dimer y enchufe transparentes.

 IP20    INCL. D
 1x150W (HA)  E27

Lampada a sospensione / Suspension lamp
Suspension / Pendelleuchte / Suspensión

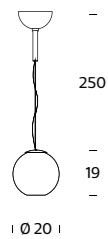

IT	EN	FR	DE	ES	
3644/0...	Lampada a sospensione. Globo in vetro soffiato metallizzato argento CR oppure rame RM . Riflettore in alluminio anodizzato. Cavo di alimentazione trasparente.	Hanging lamp. Blown glass globe, silver metallic CR or copper RM . Reflector in anodized aluminum. Clear power cable.	Suspension. Globe en verre soufflé métallisé argent CR ou cuivre RM . Réflecteur en aluminium anodisé. Câble d'alimentation transparent.	Pendelleuchte. Kugel aus geblasenem Metallic-Glas Silber CR oder Kupfer RM . Reflektor aus eloxiertem Aluminium. Transparentes Netzkabel.	Lámpara de techo. Globo de vidrio soplado metalizado plata CR o cobre RM . Reflector de aluminio anodizado. Cable de alimentación transparente.

lampadine / bulbs / ampoules / Glühbirnen / bombillas



1x40W (HA) E14 PAR16



IT	EN	FR	DE	ES	
3644...	Lampada a sospensione. Globo in vetro soffiato metallizzato argento CR oppure rame RM . Riflettore in alluminio anodizzato. Cavo di alimentazione trasparente.	Hanging lamp. Blown glass globe, silver metallic CR or copper RM . Reflector in anodized aluminum. Clear power cable.	Suspension. Globe en verre soufflé métallisé argent CR ou cuivre RM . Réflecteur en aluminium anodisé. Câble d'alimentation transparent.	Pendelleuchte. Kugel aus geblasenem Metallic-Glas Silber CR oder Kupfer RM . Reflektor aus eloxiertem Aluminium. Transparentes Netzkabel.	Lámpara de techo. Globo de vidrio soplado metalizado plata CR o cobre RM . Reflector de aluminio anodizado. Cable de alimentación transparente.

lampadine / bulbs / ampoules / Glühbirnen / bombillas

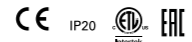

1x60W (HA) G9



IT	EN	FR	DE	ES	
3644/1...	Lampada a sospensione. Globo in vetro soffiato metallizzato argento CR oppure rame RM . Riflettore in alluminio anodizzato. Cavo di alimentazione trasparente.	Hanging lamp. Blown glass globe, silver metallic CR or copper RM . Reflector in anodized aluminum. Clear power cable.	Suspension. Globe en verre soufflé métallisé argent CR ou cuivre RM . Réflecteur en aluminium anodisé. Câble d'alimentation transparent.	Pendelleuchte. Kugel aus geblasenem Metallic-Glas Silber CR oder Kupfer RM . Reflektor aus eloxiertem Aluminium. Transparentes Netzkabel.	Lámpara de techo. Globo de vidrio soplado metalizado plata CR o cobre RM . Reflector de aluminio anodizado. Cable de alimentación transparente.

lampadine / bulbs / ampoules / Glühbirnen / bombillas



1x150W (HA) E27

GRAAL

pag. 158

Lampada da parete / Wall lamp / Applique
Wandleuchte / applique

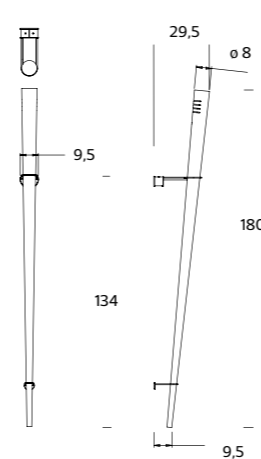

IT	EN	FR	DE	ES	
3905CR	Lampada da parete. Corpo in tubo d'acciaio conifcato a freddo cromato lucido. Doppia emissione di luce: alogena indiretta nella parte superiore, a LED diretta colore bianco nella parte inferiore con funzione di segnapasso. Alimentatore incluso.	Wall lamp. Cold-drawn chromed and polished steel tubular body. Dual-emission: upper indirect halogen beam; lower white LED marker light. Ballast included.	Applique. Corps en acier travaillé à froid chromé brillant. Double émission de lumière: indirecte halogène pour la partie supérieure, avec LED blanche directe, en tant que balisage dans la partie inférieure. Alimentation incluse.	Wandleuchte. Körper aus poliertem und verchromtem kalt konifiziertem Stahl. Doppelte Lichtausstrahlung: indirekt halogen im oberen Teil, direkt mit weißer LED als Begrenzungslicht im unteren Teil. Netzteil inbegriffen.	Lámpara de pared. Cuerpo de tubo de acero conifcado en frío cromado brillante. Doble emisión luminosa: halógena indirecta en la parte superior, de LED directa de color blanco en la parte inferior con función de indicador de paso. Alimentador incluido.

lampadine / bulbs / ampoules / Glühbirnen / bombillas



1x150W (HA) B15d + 1x1W (LED)

HUNA

pag. 160

Lampada a sospensione / Suspension lamp
Suspension / Pendelleuchte / Suspensión

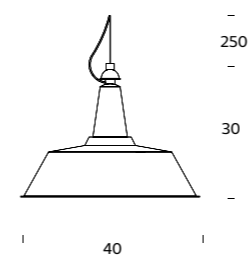

IT	EN	FR	DE	ES	
5059...	Lampada a sospensione. Montatura in metallo verniciato color alluminio AN (RAL 9006 semi-opaco), o nero N (RAL 9005 opaco) con interno bianco. Cavo di sospensione in acciaio inox. Cavo di alimentazione trasparente.	Suspension lamp. Metal frame with aluminium AN (RAL 9006 semi-matt) paint or black N (RAL 9005 matt) finish with white interior. Suspension cable in stainless steel. Transparent power cable.	Suspension. Structure en métal peint en couleur aluminium AN (RAL 9006 semi-mate) ou noir N (RAL 9005 mate) avec intérieur blanc. Câble de suspension en acier inox. Câble d'alimentation transparent.	Hängeleuchte. Metallgestell, lackiert, aluminiumfarben AN (RAL 9006 semi-matt) oder schwarz N (RAL 9005 matt), innen weiß. Aufhängekabel aus Edelstahl. Transparentes Netzkabel.	Lámpara de techo. Montura de metal pintado de color aluminio AN (RAL 9006 semi-mate), o negro N (RAL 9005 mate) con interior blanco. Cable de suspensión de acero inoxidable. Cable de alimentación transparente.

lampadine / bulbs / ampoules / Glühbirnen / bombillas



1x140W (HA) E27 or 1x20W (FL) E27

ICEBERG

pag. 162

Lampada da parete e plafone / Wall and ceiling lamp / Applique et plafonnier / Wand- und Deckenleuchte / Aplique y plafón

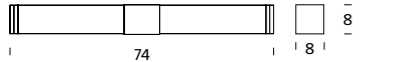
IT	EN	FR	DE	ES
<p>5446</p>  <p>Lampada da parete e plafone. Montatura in metallo verniciato alluminio. Diffusore in policarbonato opalino con testate in metacrilato trasparente.</p>	<p>Wall and ceiling lamp. Aluminium-painted metal frame. Opaline polycarbonate diffuser with transparent methacrylate heads.</p>	<p>Applique et plafonnier. Structure en métal peint en couleur aluminium. Diffuseur en polycarbonate opalin avec têtes en méthacrylate transparent.</p>	<p>Wand- und Deckenleuchte. Gestell aus aluminiumfarbig lackiertem Metall. Diffusor aus opalfarbenem Polycarbonat mit Stirnseiten aus transparentem Methacrylat.</p>	<p>Lámpara de aplique y plafón. Montura de metal pintado aluminio. Difusor de policarbonato opalino con extremos de metacrilato transparente.</p>

lampadine / bulbs / ampoules / Glühbirnen / bombillas

2×24W (FL) 2G11



IT	EN	FR	DE	ES
<p>5446/1</p>  <p>Lampada da parete e plafone. Montatura in metallo verniciato alluminio. Diffusore in policarbonato opalino con testate in metacrilato trasparente.</p>	<p>Wall and ceiling lamp. Aluminium-painted metal frame. Opaline polycarbonate diffuser with transparent methacrylate heads.</p>	<p>Applique ou plafonnier. Structure en métal peint en couleur aluminium. Diffuseur en polycarbonate opalin avec têtes en méthacrylate transparent.</p>	<p>Wand-order und Deckenleuchte. Gestell aus aluminiumfarbig lackiertem Metall. Diffusor aus opalfarbenem Polycarbonat mit Stirnseiten aus transparentem Methacrylat.</p>	<p>Lámpara de aplique y plafón. Montura de metal pintado aluminio. Difusor de policarbonato opalino con extremos de metacrilato transparente.</p>

lampadine / bulbs / ampoules / Glühbirnen / bombillas

2×55W (FL) 2G11



IGLOO

pag. 166

IT	EN	FR	DE	ES
----	----	----	----	----

Lampada a sospensione. Il modulo è in tecnopolimero plastico autoestinguente, disponibile nei colori RAL bianco grigio **GC** (RAL 9002) e grigio scuro **GS** (RAL 7015) Per quantitativi superiori ai 30 corpi, è possibile ordinare colori scala RAL o RAL DESIGN a scelta del cliente. I cavi di sospensione sono in acciaio. Il cavo di alimentazione è trasparente. Il rosone è dello stesso colore del modulo. L'apparecchio è provvisto di Led a tensione di rete e l'emissione luminosa è regolabile con dimmer standard Led compatibili. E' disponibile in versione singola con la sorgente luminosa rivolta verso il basso (down light), in versione in linea a 3 e a 5 moduli con i moduli di testa sempre down light e quelli centrali tutti down light oppure alternati down light e up light, in versione a 4 quadrata tutti down light oppure down light e up light e in versione a 5 moduli in verticale, tutti disposti nello stesso senso. Gli apparecchi sono forniti completi di dima per facilitare l'installazione.

Gli apparecchi di illuminazione non sono componibili gli uni con gli altri. Per composizioni diverse da quelle indicate, fare riferimento a Igloo Sistema.

Suspension lamp. The module is in self-extinguishing technopolymer plastic, available in RAL colours white grey **GC** (RAL 9002) and dark grey **GS** (RAL 7015) Quantities exceeding 30 units can be ordered in RAL or RAL DESIGN colours chosen by the client. The hanging wires are in steel. The power cable is transparent. The canopy is in the same colour as the unit. The lamp is fitted with line voltage Led and light emission can be adjusted with standard dimmers for Led light sources. It is available in a single downlighting version, in a 3- or 5-unit in-line version, with fixed downlighting for the end units and either all downlighting for the central ones or alternate down-and uplighting, in a 4-unit version with all-downlighting or down-and uplighting units and in a 5-unit vertical version, with all units pointing in the same direction. They all come with templates for easy installation.

These lamps cannot be assembled with each other. Please refer to Igloo System for layouts other than those listed here.

Lampe à suspension. Le corps est en technopolymère plastique autoextinguible, disponible dans les couleurs blanc grisé **GC** (RAL 9002) et gris foncé **GS** (RAL 7015) Pour des quantités supérieures à 30 modules, le client peut choisir la couleur de son choix dans les nuanciers RAL ou RAL DESIGN. Les câbles de suspension sont en acier. Le câble d'alimentation est transparent. La rosace est de la même couleur que le module. Le luminaire est muni de Led sous alimentation réseau et l'émission lumineuse est réglable au moyen de variateurs compatibles avec des sources Led. Il est disponible en version simple avec la source lumineuse orientée vers le bas (down light), en version linéaire à 3 ou 5 modules, celui de tête étant toujours orienté down light ainsi que les suivants ou alternés down et up light. En version carrée à 4 modules l'orientation est intégralement down light ou down light et up light. En version 5 modules verticaux, ils sont tous disposés dans le même sens. Ils sont tous fournis avec un gabarit pour faciliter l'installation.

Les luminaires ne sont pas combinables les uns avec les autres. Pour des compositions différentes de celles qui sont indiquées, faire référence à Igloo Système.

Pendelleuchte. Der Leuchtenkörper besteht aus selbstverlöschendem Technopolymer und ist in den RAL-Farben Weiß, Grau **GC** (RAL 9002) und Dunkelgrau **GS** (RAL 7015) erhältlich. Für größere Mengen als 30 Körper können je nach Wahl des Kunden Farben in der RAL- oder RAL DESIGN-Skala bestellt werden. Die Aufhängekabel sind aus Stahl gefertigt. Das Netzkabel ist transparent. Der Deckenbaldachin hat die gleiche Farbe des Moduls. Das Gerät ist mit Leds für Netzspannung ausgestattet und die Helligkeit ist durch entsprechende Licht-Dimmer für Led-Lichtquellen einstellbar. Es ist in der Einzelausführung mit nach unten gerichteter Leuchtquelle (Down Light) erhältlich, steht in der Ausführung in Reihe zu 3 und 5 Modulen immer mit Down Light-Modulen am jeweiligen Ende und den zentralen Modulen Down Light oder abwechselnd Down Light und Up Light zur Verfügung, und ist in der quadratischen 4er-Ausführung mit allen Leuchtquellen nach unten oder nach oben gerichtet und in der 5-er Ausführung senkrecht erhältlich, wobei alle in derselben Richtung angeordnet sind. Für eine einfache Installation werden alle Komplettleuchten mit einer Montageschablone geliefert.

Die Komplettleuchten sind nicht erweiterbar. Für andere Zusammensetzungen als die angegebenen bitte auf das Igloo System Bezug nehmen.

Lámpara de techo. El cuerpo es de tecnopolimero plástico ignifugo, disponible en los colores RAL blanco grisáceo **GC** (RAL 9002) y gris oscuro **GS** (RAL 7015) Para cantidades superiores a 30 módulos, se pueden encargar colores RAL o RAL DESIGN a elección del cliente. Los cables de suspensión son de acero. El florón es del mismo color que el módulo. El aparato está provisto de Led a tensión de red y la fuente de luz puede regularse utilizando un dimer compatible con Leds. Está disponible en versión individual con la fuente de luz dirigida hacia abajo (down light), en versión de 3 y de 5 módulos en línea con los módulos de los extremos orientados siempre hacia abajo y los centrales también hacia abajo o alternados hacia abajo y hacia arriba, en versión cuadrada con 4 módulos orientados hacia abajo o alternados hacia arriba y abajo, y en versión de 5 módulos en vertical, con todos los módulos en el mismo sentido. Se suministran siempre con un patrón para facilitar su instalación.

Las composiciones ya predisuestas no pueden combinarse entre sí. Para composiciones distintas de las indicadas, ver Sistema Igloo.

IGLOO SYSTEM

pag. 312

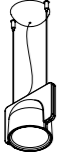

4268../LED/1DOWN

Modulo singolo 10W Led a tensione di rete / Single module 10W Led line voltage / Module 10W Led alimentation réseau / Led Module 10W Led mit Netzspannung / Módulo 10W Led a tensión de red

22x17,5x14,8 + 250 cable

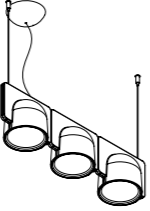

4268../LED/3DOWN

3 moduli 3x10W Led a tensione di rete / 3 modules 3x10W Led line voltage / 3 modules 3x 10W Led alimentation réseau / 3 Module 3x10W Led mit Netzspannung / 3 módulos 3x10W Led a tensión de red

66x17,5x14,8 + 250 cable

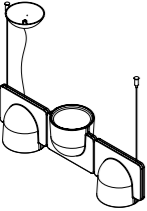

4268../LED/3DOWN/UP

3 moduli 3x10W Led a tensione di rete / 3 modules 3x10W Led line voltage / 3 modules 3x 10W Led alimentation réseau / 3 Module 3x10W Led mit Netzspannung / 3 módulos 3x10W Led a tensión de red

66x17,5x14,8 + 250 cable

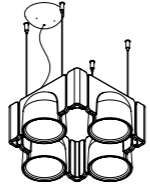

4268../LED/4QDOWN

4 moduli 4x10W Led a tensione di rete / 4 modules 4x10W Led line voltage / 4 modules 4x10W Led alimentation réseau / 4 Module 4x10W Led mit Netzspannung / 4 módulos 4x10W Led a tensión de red

22x17,5x22 + 250 cable

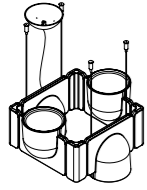

4268../LED/4QD/UP

4 moduli 4x10W Led a tensione di rete / 4 modules 4x10W Led line voltage / 4 modules 4x 10W Led alimentation réseau / 4 Module 4x10W Led mit Netzspannung / 4 módulos 4x10W Led a tensión de red

22x17,5x22 + 250 cable

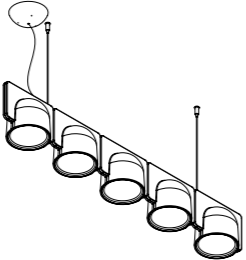

4268../LED/5DOWN

5 moduli 5x10W Led a tensione di rete / 5 modules 5x10W Led line voltage / 5 modules 5x 10W Led alimentation réseau / 5 Module 5x10W Led mit Netzspannung / 5 módulos 5x10W Led a tensión de red.

110x17,5x14,8 + 250 cable

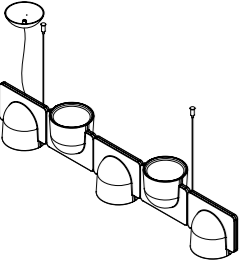

4268../LED/5DOWN/UP

5 moduli 5x10W Led a tensione di rete / 5 modules 5x10W Led line voltage / 5 modules 5x 10W Led alimentation réseau / 5 Module 5x10W Led mit Netzspannung / 5 módulos 5x10W Led a tensión de red

110x17,5x14,8 + 250 cable

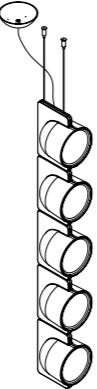

4268../LED/5V

5 moduli 5x10W Led a tensione di rete / 5 modules 5x10W Led line voltage / 5 modules 5x 10W Led alimentation réseau / 5 Module 5x10W Led mit Netzspannung / 5 módulos 5x10W Led a tensión de red

17,5x110x14,8 + 250 cable

Cavo di alimentazione lunghezza 250 cm e Ø 4,6 mm Supply cable length 250 cm and Ø 4,6 mm Câble d'alimentation 250 cm de longueur et Ø 4,6 Zuleitung 250 cm und Ø 4,6 mm Cable de alimentación longitud 250 cm y Ø 4,6 mm

lampadine / bulbs / ampoules / Glühbirnen / bombillas  IP20  Classe II   A++  INCL. LED NOT REPLACEABLE



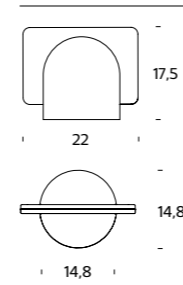



○ 10W LED LINE VOLTAGE (2700 K, CRI 80, 1250 Lm)



IT	EN	FR	DE	ES
<p>Igloo rappresenta una grande innovazione nel segmento degli spot lights a sospensione. E' un sistema di illuminazione modulare autoportante che, grazie a connessioni elettromeccaniche, curve e distanziali, consente il collegamento consecutivo di più apparecchi con singola alimentazione. La doppia scocca in tecnopolimero plastico autoestinguento consente una facile installazione dei moduli sia in verticale che in orizzontale ed in entrambi i casi permette di disporre i moduli up light o down light direttamente in fase di installazione. Igloo è quindi un modulo versatile, duplicabile all'infinito e flessibile. Utilizza il Led a tensione di rete come sorgente luminosa ed è adatto sia per installazioni contract in ambito retail, hospitality, ufficio e commercial (in cui sia necessario realizzare composizioni più o meno complesse), sia in ambito residenziale, con valenza maggiormente decorativa. La versatilità è la chiave di questo prodotto in quanto rende possibile un'illuminazione diffusa in spazi di ogni dimensione e si presta a qualsiasi esigenza e necessità di illuminazione. L'emissione luminosa è regolabile con dimmer standard compatibili con sorgenti luminose a Led. Il sistema include, oltre ai moduli singoli provvisti di Led che hanno il diffusore opalino, anche moduli non provvisti di Led (ciechi). Si suggerisce che questi ultimi, dotati di un coperchio verniciato dello stesso colore RAL del corpo, vengano installati rivolti verso l'alto. I moduli vengono forniti aperti e una volta chiusi, non è più possibile intervenire sugli stessi. È necessario infine prevedere un kit di sospensione, che include i cavi in acciaio, da impiegare ogni 4 moduli, e un kit di alimentazione (con modulo, cavo trasparente e rosone dello stesso colore del modulo) ogni 100 moduli. I moduli sono disponibili nei colori RAL bianco grigio GC (RAL 9002) e grigio scuro GS (RAL 7015).</p>	<p>Igloo represents the great innovation in suspended spotlights. It is in fact a modular, self-supporting lighting system that, thanks to a series of electromechanical connections, curves and spacers, allows for consecutive linking of units to just one power point. The double shell in self-extinguishing plastic technopolymer makes for easy installation of the units, whether vertically or horizontally, and in either case allows for uplighting or downlighting to be chosen during installation. Igloo ensures versatile, infinitely replicable modularity. It uses line voltage Leds as the light source and is suitable for contract installation in the retail, hospitality, office and business sectors, where compositions can be as complex or as simple as required, or in homes, with a more decorative effect. Versatility is the key to this product as it makes diffused lighting possible in rooms of any size and can meet any lighting requirement. Light emission can be adjusted with standard dimmers for Led light sources. In addition to the individual units with opaline diffuser and Led bulb, the system also includes blind units with no bulb. The latter have a cover painted in the same RAL colour as the body and should be installed pointing upwards. The units are supplied open and cannot be altered once closed. One suspension kit with steel wires is needed every 4 units and just one power kit (with module, transparent cable and canopy in the same colour as the module) every 100 modules. The units are available in RAL colours white grey GC (RAL 9002) and dark gray GS (RAL 7015).</p>	<p>Igloo constitue une grande innovation dans le secteur des spots suspendus. Il s'agit en effet d'un système d'éclairage modulaire autoporteur qui, grâce à des connexions électromécaniques, angles et entretoises, permet de connecter en continuité plusieurs luminaires via une seule source d'alimentation. La double coque en technopolymère plastique autoextinguible rend l'installation des modules facile, aussi bien verticalement qu'horizontalement et, dans les deux cas, permet d'orienter le flux lumineux vers le haut ou le bas au moment de l'installation. Igloo est donc un module polyvalent, duplicable à l'infini et flexible. Le système utilisant une source Led sous alimentation réseau, est adapté aussi bien aux espaces collectifs et commerciaux, en hôtellerie, ou encore en milieu tertiaire, où il est nécessaire de réaliser des compositions plus ou moins complexes, que pour l'habitat, où prime leur valeur décorative. L'atout de ce produit est sa polyvalence car il rend possible un éclairage diffus dans des espaces de toutes dimensions et répond à tous les types d'exigences et de besoins d'éclairage. L'émission lumineuse est réglable au moyen de variateurs compatibles avec des sources lumineuses Led. Le système comprend non seulement les différents modules Led, avec diffuseur opalin, mais aussi des modules sans aucune source (fermés). Il est conseillé d'installer ces derniers, dotés d'un couvercle inférieur, laqué dans la même couleur RAL que le corps, orientés vers le haut. Les modules sont fournis ouverts et, une fois fermés, il n'est plus possible d'intervenir dessus. Enfin, il est nécessaire de prévoir tous les 4 modules un kit de suspension, qui comprend les câbles en acier. Tous les 100 modules un kit d'alimentation est nécessaire (avec module, câble transparent et rosace de la même couleur que le module). Les modules sont disponibles dans les couleurs blanc grisé GC (RAL 9002) et gris foncé GS (RAL 7015).</p>	<p>Igloo stellt eine große Innovation im Segment der Pendelstrahler dar. Es ist ein selbsttragendes modulares Beleuchtungssystem, das aufgrund elektromechanischer Verbindungen mit Winkeln und Abstandshaltern die aufeinander folgende Verbindung mehrerer Geräte (bis zu zweihundert Module) mit Einzelstromversorgung möglich macht. Der Doppelaufbau aus selbstverlöschendem Technopolymer erlaubt eine einfache senkrechte und waagerechte Installation der Module und in beiden Fällen können die Module mit Licht nach oben oder unten direkt bei der Installation angeordnet werden. Igloo ist also ein vielseitiges System, das nahezu unendlich vervielfacht werden kann und flexibel ist. Das System nutzt als Lichtquelle Led Platinen mit Netzspannung und eignet sich für den Einbau im Objektbereich in Einzelhandel, Gastronomie, Büro und Gewerbe, wo mehr oder weniger komplexe Zusammenstellungen notwendig sind, sowie im Wohnbereich mit überwiegend dekorativem Wert. Der Schlüssel dieses Produkts ist seine vielseitige Verwendung, da es eine diffuse Beleuchtung in Räumen aller Größen ermöglicht und sich für jeden Beleuchtungszweck und -bedarf eignet. Die Helligkeit kann durch spezielle Licht-Dimmer für Led-Lichtquellen reguliert werden. Das System beinhaltet, zusätzlich zu den einzelnen Modulen mit Leds, die einen Diffusor in Opalweiß haben, auch Leermodule ohne Leds. Es wird empfohlen, letztere, die mit der in der gleichen RAL-Farbe des Körpers lackierten Abdeckung versehen sind, nach oben gerichtet zu installieren. Die Module werden offen geliefert, einmal geschlossen, können diese nicht mehr geöffnet werden. Alle 4 Module muss eine Seilabhangung installiert werden. Die Einspeisung mit transparenter Zuleitung wird mit einem Module und mit einem Deckenbaldachin in Systemfarbe geliefert. Die Einspeisung versorgt bis zu 100 Module. Die Module sind in den RAL-Farben Weiß Grau GC (RAL 9002) und Dunkelgrau GS (RAL 7015) erhältlich.</p>	<p>Igloo representa una gran innovación en el segmento de los focos de techo. Se trata de un sistema de iluminación modular autoportante que, gracias a sus conexiones electromecánicas, curvas y distanciadores, permite conectar de modo consecutivo varios módulos con un único punto de alimentación. El doble armazón fabricado con un tecnopolímero plástico ignifugo permite la instalación de los módulos tanto en vertical como en horizontal y, en ambos casos, ofrece la posibilidad de orientarlos hacia un lado u otro durante la fase de instalación. Igloo es por lo tanto un módulo versátil, reproducible hasta el infinito y flexible. El sistema utiliza como fuente de luz el Led a tensión de red y es idóneo para las instalaciones contract ya sean en ámbito hotelero, corporativo o comercial, donde es necesario realizar composiciones más o menos complejas; o en ámbito residencial, donde resalta su valor decorativo. La versatilidad es la clave de este proyecto, dado que permite aplicar una luz difusa en espacios de todas las dimensiones y se presta a cualquier exigencia y necesidad de iluminación. La emisión de luz puede regularse con fuentes de luz Led. Además de los módulos individuales provistos de Led, con difusor opalino, el sistema incluye módulos sin Led (ciegos). Estos últimos están dotados de una tapa inferior pintada en el mismo color RAL que el cuerpo y es preferible instalarlos orientados hacia arriba. Los módulos se suministran abiertos y después de cerrarlos no se puede intervenir en ellos. Por último, es necesario utilizar un kit de suspensión cada 4 módulos, que incluye los cables de acero, y un kit de alimentación (con modulo, cable transparente y florón del mismo color que el módulo) cada 100 módulos. Los módulos están disponibles en los colores RAL blanco grisáceo GC (RAL 9002) y gris oscuro GS (RAL 7015).</p>

lampadine / bulbs / ampoules / Glühbirnen / bombillas  IP20  Classe II   A++  INCL. LED NOT REPLACEABLE

○ 10W LED LINE VOLTAGE (2700 K, CRI 80, 1250 Lm)

Elements	IT	EN	FR	DE	ES
	E4268... Kit di alimentazione (modulo + cavo di alimentazione lunghezza 250 cm e Ø 5,9 mm + rosone) da ordinare ogni 100 moduli	Supply kit (module + supply cable length 250 cm and Ø 5,9 mm + canopy) to be ordered every 100 modules	Kit électrification (module + câble d'alimentation 250 cm de longueur et Ø 5,9 mm + rosace) à acheter tous les 100 modules	Einspeisung (Module + Zuleitung 250 cm und Ø 5,9 mm + Deckenbaldachin) Eine Einspeisung kann bis zu 100 Module versorgen	Kit de alimentación (módulo + cable de alimentación longitud 250 cm y Ø 5,9 mm + florón) uno cada 100 módulos
	4268../LED Modulo 10W Led a tensione di rete	Module 10W Led line voltage	Module 10W Led alimentation réseau	Module 10W Led mit Netzspannung	Módulo 10W Led a tensión de red
					
	S4268 Kit sospensione da acquistare ogni 4 moduli singoli (con 2 cavi lunghezza max 250 cm)	Suspension kit to be purchased every 4 single units (with 2 wires 250 cm max length)	Kit de suspension à acheter tous les 4 modules simples (avec 2 câbles de 250 cm de longueur max)	Seilabhängung zu verwenden an jedem 4. Einzelmodul (mit 2 Kabel mit Seillänge max 250 cm)	Kit de suspensión es necesario disponer de un kit de suspensión para cada 4 módulos (con 2 cables longitud máx 250 cm)
	C4268.. Giunto angolare 90° 5 x 5 x 14,6 cm	Joint 90° 5 x 5 x 14,6 cm	Pièce angulaire de 90° 5 x 5 x 14,6 cm	Winkel 90° 5 x 5 x 14,6 cm	Pieza angular de 90° 5 x 5 x 14,6 cm
	4269../NOLED Modulo senza Led (con alimentazione). Si suggerisce di installare il modulo senza Led con il coperchio rivolto verso l'alto. Il modulo senza Led trasmette comunque l'alimentazione.	Module without Led (with power). The unit without Led bulb and with cover should be installed pointing upwards. The module with no Led bulb does however transmit power to the next unit in the series.	Module sans Led (avec alimentation). Il est conseillé d'installer le module sans Led avec le couvercle orienté vers le haut. Le module simple sans Led transmet quand même l'alimentation au module suivant.	Module ohne Led (mit Durchgangsverdrahtung). Wir empfehlen Leermodule ohne Led nach oben ausgerichtet zu montieren. Das Leermodule verfügt über eine Durchgangsverdrahtung.	Módulo sin Led (con corriente). Se aconseja instalar el módulo sin Led con la tapa orientada hacia arriba. El módulo individual sin Led también transmite la corriente.
	Tutti i moduli vengono forniti aperti per decidere in quale verso direzionarli in fase di installazione.	All modules are supplied opened so they can be installed pointing either up or down.	Tous les modules sont fournis ouverts pour pouvoir décider dans quel sens les installer.	Alle Module werden unmontiert geliefert damit die Ausrichtung der Lichtköpfe bei der Montage frei gewählt werden kann.	Todos los módulos se suministran abiertos para decidir la dirección en la que se desea instalarlos.

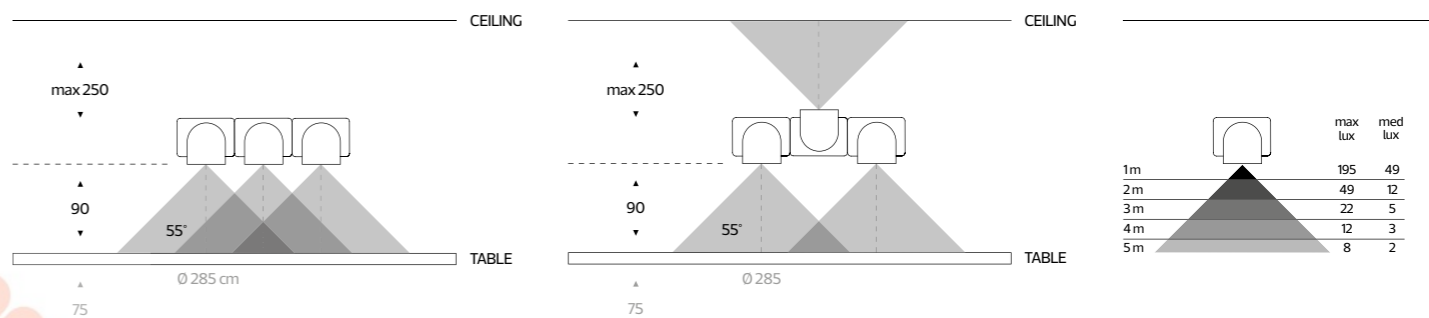
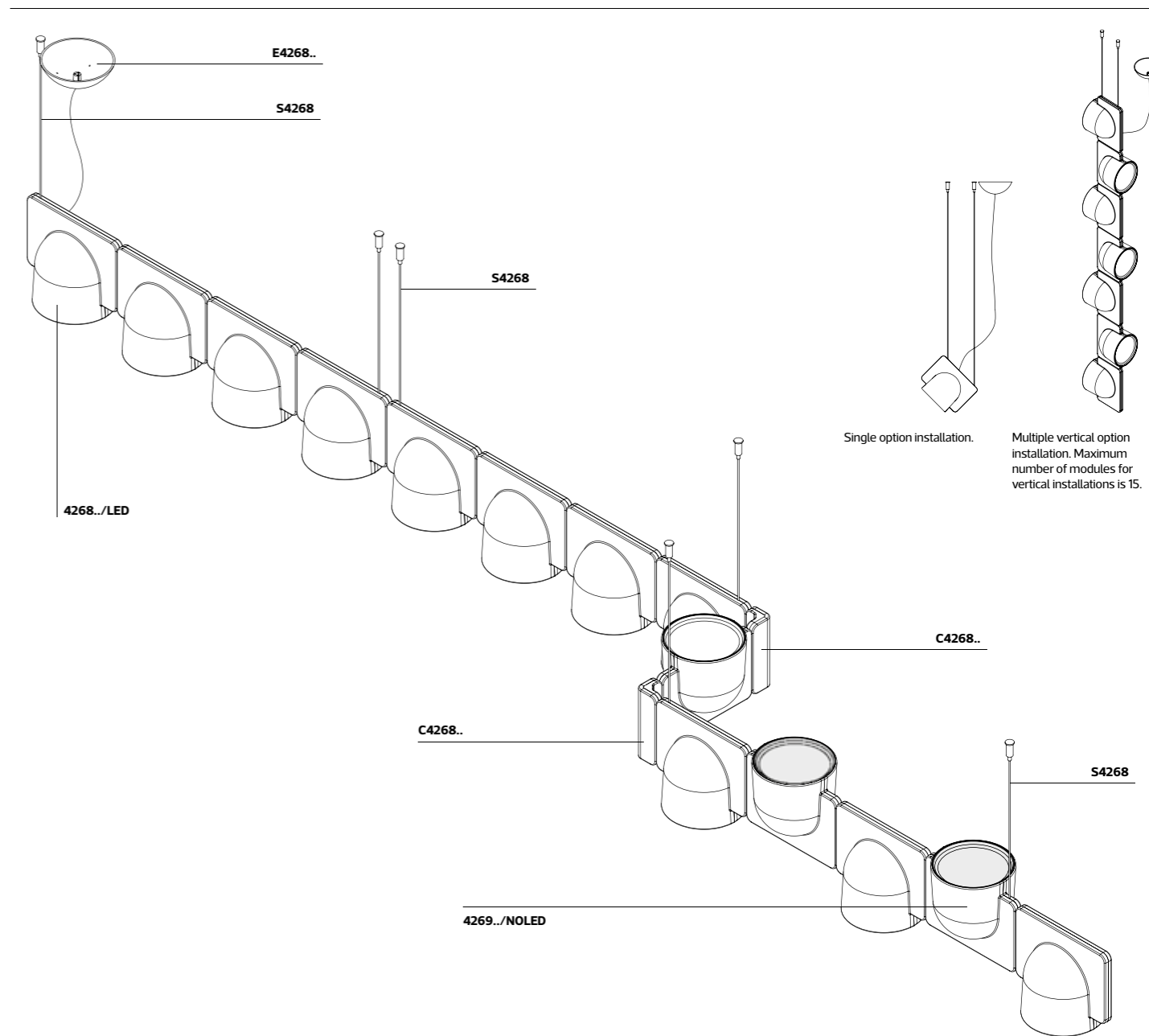

Lampada da parete / Wall lamp / Applique
Wandleuchte / applique

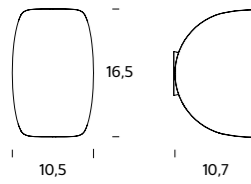
IT	EN	FR	DE	ES
 <p>4299..</p> <p>Lampada da parete. Corpo in alluminio verniciato esternamente nei colori grigio antracite GS (RAL 7024 opaco), rosso R (RAL 3011 opaco), bianco BI (RAL 9016 opaco) e blu BL (RAL 5001 opaco), internamente colore bianco. Grazie alla montatura dal doppio asse di rotazione, la lampada si muove sia sull'asse longitudinale sia lungo quello trasversale, consentendo una gestione totale della luce. Con un movimento Up/Down sul diffusore esterno è possibile inoltre aprire e chiudere il fascio luminoso. Dimmerabile con apposito light dimmer, non fornito.</p>	<p>Wall lamp. Body in aluminium, painted in 4 matt-finish colors: graphite grey GS (RAL 7024 matt), red R (RAL 3011 matt), white BI (RAL 9016 matt) and blue BL (RAL 5001 matt), while the inside is white. Thanks to its dual-axis rotation frame, it has the distinguishing feature rotating on both longitudinal and transverse axes, for total light management. The Up/Down movement on the external diffuser widens and narrows the ray of light. Dimmable with light dimmer, not supplied.</p>	<p>Applique. Corps en aluminium verni en couleurs gris anthracite GS (RAL 7024 mat), rouge R (RAL 3011 mat), blanc BI (RAL 9016 mat) et bleu BL (RAL 5001 mat), avec intérieur blanc. Grâce à une structure avec double axe de rotation, la lampe tourne aussi bien sur l'axe longitudinal que sur l'axe transversal, permettant une gestion totale. Avec un mouvement up/down sur le diffuseur externe, il est possible par ailleurs d'ouvrir ou de fermer le faisceau lumineux. Variation de lumière possible par module externe (non fourni).</p>	<p>Wandleuchte. Körper aus Aluminium, in 4 Farben matt lackiert: Graphitgrau GS (RAL 7024 matt), Rot R (RAL 3011 matt), Weiß BI (RAL 9016 matt) und Blau BL (RAL 5001 matt), während das Innere weiß ist. Die Leuchte lässt sich dank eines Gehäuses mit Doppeldrehachse sowohl auf der Längsachse als auch längs der Querachse verstellen. Mit einer Auf- und Ab-Bewegung am äußeren Diffusor kann der Lichtstrahl außerdem geöffnet und geschlossen werden. Dimmbar mit separaten LED-Dimmer (nicht im Lieferumfang enthalten).</p>	<p>Aplique de pared. Cuerpo y pantalla en aluminio. Pantalla pintada con acabado mate en 4 colores: grafito GS (RAL 7024 mat), rojo R (RAL 3011 mat), blanco BI (RAL 9016 mat) y azul BL (RAL 5001 mat), mientras que la parte interna es de color blanco. Gracias a un mecanismo de doble eje de rotación, la pantalla puede girar tanto sobre el eje longitudinal como sobre el transversal. Con un movimiento Up/Down de la pantalla se puede abrir y cerrar el haz de luz. Dimerable con un dimer remoto (no incluido).</p>

lampadine / bulbs / ampoules / Glühbirnen / bombillas



- 2 LED - 4,5W (2700 K, CRI>80, 350+350 Lm)

KIASMA

pag. 174

Lampada da parete / Wall lamp / Applique
Wandleuchte / Applique

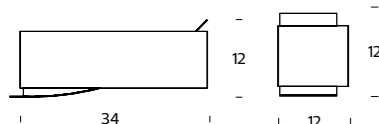
IT	EN	FR	DE	ES
 <p>5333A</p> <p>Lampada da parete. Struttura con due lastre in metallo curvato verniciato color nickel (RAL 9006 matt).</p>	<p>Wall lamp. Frame with two curved nickel-painted metal plates (RAL 9006 matt).</p>	<p>Applique. Structure avec deux plaques en métal courbé peint en couleur nickel (RAL 9006 matt).</p>	<p>Wandleuchte. Struktur mit zwei nickelfarbig lackierten, gebogenen Metallplatten (RAL 9006 matt).</p>	<p>Lámpara de pared. Estructura con dos placas de metal curvado pintado color níquel (RAL 9006 matt).</p>

lampadine / bulbs / ampoules / Glühbirnen / bombillas



- ☞ 1x150W (HA) (ES) E27 or
- ☞ 1x20W (FL) E27

Lampada da tavolo / Table lamp / Lampe de table / Tischleuchte / Lámpara de sobremesa

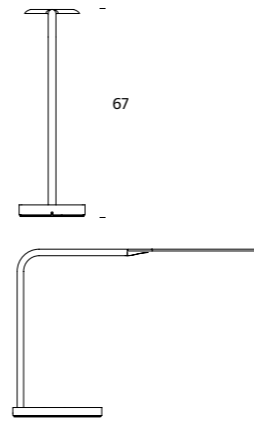
IT	EN	FR	DE	ES	
 <p>4312..</p>	<p>Lampada da tavolo. Testa in lega di alluminio e base in lega di zama entrambi pressofusi; diffusore in tecnopolimero. Driver su cavo con plug intercambiabile in funzione della presa di alimentazione e cavo di alimentazione "plug&play", colore nero. Gestione ON/OFF e regolazione dell'intensità luminosa sulla base. La lampada è provvista di porta USB (1A - 5V) per la ricarica di dispositivi cellulari. Disponibile nei colori nero N (RAL9005), bianco BI (RAL9003) e rosa RS (RAL4003).</p>	<p>Table lamp. Head in aluminium alloy and base in zama alloy, both die cast; diffuser made of polymer. Driver on cable with multiple and "plug&play" power cord, both black. ON / OFF control and dimmer on the base. The lamp is provided with USB port (1A - 5V) for charging cellular devices. Available in black N (RAL9005), white BI (RAL9003) and pink RS (RAL4003).</p>	<p>Lampe de table. Tête en alliage d'aluminium et base en alliage zamac, moulées sous pression. Diffuseur en polymère. Driver sur câble avec prise multi standard "plug&play" et cordon d'alimentation noirs. Allumage et régulation d'intensité lumineuse sur la base. La lampe est munie d'un port USB (1A - 5V) pour recharge d'appareils. Disponible en noir N (RAL9005), blanc BI (RAL9003) et rose RS (RAL4003).</p>	<p>Tischleuchte. Kopf aus Aluminium- Druckguss und Basis aus Zamak- Druckguss; Diffusor aus Kunststoff. Steckerkonverter mit Multistecker an schwarzer Zuleitung. Ein/ Ausschalter und Dimmer auf der Basis. Ebenfalls in der Basis integrierter USB Anschluss (1A - 5V) zum laden von geeigneten Mobiltelefonen. Erhältlich in schwarz N (RAL9005), weiss BI (RAL9003) oder pink RS (RAL4003).</p>	<p>Lámpara de mesa. Cabeza en aluminio y base en zamak, ambos producidos por presofusión; pantalla en tecnopolimero. Transformador con clavija intercambiable en función de la entrada del enchufe y cable de alimentación "plug&play" de color negro. Gestión del ON/OFF y variación de la intensidad de la luz desde la base. La lámpara tiene una entrada USB (1A - 5V) para la carga de dispositivos móviles. Disponible en color negro N (RAL9005), blanco BI (RAL9003) y rosa RS (RAL4003).</p>

lampadine / bulbs / ampoules / Glühbirnen / bombillas



- 1 LED - 7,5W (2700 K, CRI >80, 940 Lm)

KODO IP65

pag. 332

Esterno / Outdoor / Exterieur
Außen / Exterior

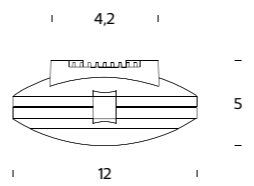
IT	EN	FR	DE	ES	
 <p>3099CR</p>	<p>Lampada da parete/plafone per esterno, a tensione di rete o a bassa tensione. Corpo in lega d'alluminio pressofuso verniciato al poliestere previa fosfocromatazione, disponibile cromato. Diffusore in vetro prismaticizzato.</p>	<p>Outdoor wall/ceiling lamp for mains or low voltage connection. Die-cast aluminium alloy body, phosphochromated then given a polyester finish, available in chromed. Prismatic glass diffuser.</p>	<p>Applique ou plafonnier d'extérieur, à basse tension ou à tension réseau. Corps en alliage d'aluminium moulé sous pression, peint au polyester après phosphochromatation, disponible en chromé. Diffuseur en verre prismatique.</p>	<p>Wand- oder Deckenleuchte für Außenbereich, Netzspannung oder Niederspannung. Körper aus einer Legierung aus druckgegossenem Aluminium, polyesterlackiert nach vorheriger Phospho-Chromatisierung, erhältlich verchromt. Diffusor aus prismaticisiertem Glas.</p>	<p>Lámpara de pared/plafón para exteriores. Funcionamiento con tensión de red o baja tensión. Cuerpo de aleación de aluminio moldeado a presión pintado en poliéster después de someterlo a fosfocromación, disponible en cromado. Difusor de vidrio prismático.</p>

lampadine / bulbs / ampoules / Glühbirnen / bombillas

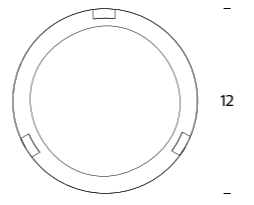

- ☞ 1x50W (HA) (ES) GY6.35 12V
- ☞ 1x35W (HA) (ES) GY6.35 12V

 <p>3099CR/230</p>	<p>Lampada da parete/plafone per esterno, a tensione di rete o a bassa tensione. Corpo in lega d'alluminio pressofuso verniciato al poliestere previa fosfocromatazione, disponibile cromato. Diffusore in vetro prismaticizzato.</p>	<p>Outdoor wall/ceiling lamp for mains or low voltage connection. Die-cast aluminium alloy body, phosphochromated then given a polyester finish, available in chromed. Prismatic glass diffuser.</p>	<p>Applique ou plafonnier d'extérieur, à basse tension ou à tension réseau. Corps en alliage d'aluminium moulé sous pression, peint au polyester après phosphochromatation, disponible en chromé. Diffuseur en verre prismatique.</p>	<p>Wand- oder Deckenleuchte für Außenbereich, Netzspannung oder Niederspannung. Körper aus einer Legierung aus druckgegossenem Aluminium, polyesterlackiert nach vorheriger Phospho-Chromatisierung, erhältlich verchromt. Diffusor aus prismaticiertem Glas.</p>	<p>Lámpara de pared/plafón para exteriores. Funcionamiento con tensión de red o baja tensión. Cuerpo de aleación de aluminio moldeado a presión pintado en poliéster después de someterlo a fosfocromación, disponible en cromado. Difusor de vidrio prismático.</p>
----------------------------------------------------------------------------------------------------------------	---------------------------------------------------------------------------------------------------------------------------------------------------------------------------------------------------------------------------------------	------------------------------------------------------------------------------------------------------------------------------------------------------------------------------------------------------	---------------------------------------------------------------------------------------------------------------------------------------------------------------------------------------------------------------------------------------	-------------------------------------------------------------------------------------------------------------------------------------------------------------------------------------------------------------------------------------------------------------------	----------------------------------------------------------------------------------------------------------------------------------------------------------------------------------------------------------------------------------------------------------------------

lampadine / bulbs / ampoules / Glühbirnen / bombillas



- ☞ 1x40W (HA) (ES) G9 or
- ☞ 1x33W (HA) (ES) G9

KOHO

pag. 334

Esterno / Outdoor / Extérieur
Außen / Exterior

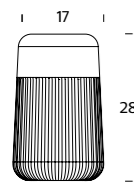

4249...

Lampada da esterno, portatile e ricaricabile. Coperchio in policarbonato disponibile in tre varianti di colore: grigio **G** (RAL 7032 opaco), giallo **GI** (RAL 1018 opaco) e blu **BL** (RAL 5021 opaco). Corpo in polietilene opalino bianco latte. Interruttore touch a due livelli di illuminazione (100% - 50%). Autonomia della batteria di circa 7 ore al 100% di luminosità oppure di 19 ore al 50% di luminosità.

Outdoor lamp, portable and rechargeable. Lid in polycarbonate available in three different colors: grey **G** (RAL 7032 matt), yellow **GI** (RAL 1018 matt) and blue **BL** (RAL 5021 matt). Body in milk white opaline polyethylene. Touch switch with two illumination levels (100% - 50%). Approximately 7 hours battery autonomy at 100% brightness or 19 hours at 50% brightness.

Lampe d'extérieur, portable et rechargeable. Couvercle en polycarbonate disponible en trois couleurs : gris **G** (RAL 7032 mate), jaune **GI** (RAL 1018 mate) et bleu **BL** (RAL 5021 mate). Corps en polyéthylène blanc lait opalin. Interrupteur à commande tactile à deux niveaux d'éclairage (100% - 50%). Autonomie de la batterie d'environ 7 heures à 100% de luminosité ou 19 heures à 50% de luminosité.

Tragbare und wiederaufladbare Außenleuchte. Abdeckung aus Polycarbonat, erhältlich in drei verschiedenen Farben: grau **G** (RAL 7032 matt), gelb **GI** (RAL 1018 matt) und blau **BL** (RAL 5021 matt). Körper aus opalmilchweißem Polyethylen. Touch-Schalter mit zwei Lichtstärkepegeln (100% - 50%). Batterie Lebensdauer von ca. 7 Stunden bei 100% Helligkeit oder 19 Stunden bei 50% Helligkeit.

Lámpara para exteriores portátil y recargable. Tapa de policarbonato disponible en tres variantes de color: gris **G** (RAL 7032 mate) (RAL 7032 mate), amarillo **GI** (RAL 1018 mate) y azul **BL** (RAL 5021 mate). Cuerpo de polietileno opalino blanco leche. Interruptor táctil con dos niveles de iluminación (100% - 50%). Autonomía de la batería de unas 7 horas al 100% de luminosidad o de 19 horas a 50% de luminosidad.

lampadine / bulbs / ampoules / Glühbirnen / bombillas



IP65

Classe II



A++

INCL. LED

NOT REPLACEABLE

○ 3W LED (3000 K, CRI>80, 250lm) 12V

Lampada a sospensione / Suspension lamp
Suspension / Pendelleuchte / Suspensión

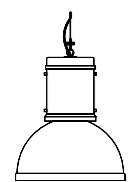

5000AN

Lampada a sospensione. Montatura in alluminio naturale (RAL 9006). Riflettore verniciato bianco all'interno. Cavo di sospensione in acciaio inox. Cavo di alimentazione trasparente.

Suspension lamp. Frame in natural aluminium (RAL 9006). Reflector with white painted interior. Stainless steel suspension cable. Transparent power cable.

Suspension. Structure en aluminium naturel (RAL 9006). Réflecteur peint en blanc à l'intérieur. Câble de suspension en acier inox. Câble d'alimentation transparent.

Hängeleuchte. Gestell aus natürlichem Aluminium (RAL 9006). Reflektor innen weiß lackiert. Aufhängekabel aus Edelstahl. Transparentes Netzkabel.

Lámpara de techo. Montura de aluminio natural (RAL 9006). Reflector pintado blanco en el interior. Cable de suspensión de acero inoxidable. Cable de alimentación transparente.

lampadine / bulbs / ampoules / Glühbirnen / bombillas



IP20

Classe II



D-E

⦿ 1x60W (IN) E27 or

⦿ 1x42W (HA) Ⓢ E27

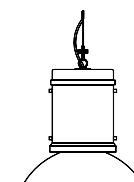

5000/1...

Lampada a sospensione. Montatura in alluminio naturale **AN** (RAL 9006) oppure cromato **CR**. Riflettore verniciato bianco all'interno. Cavo di sospensione in acciaio inox. Cavo di alimentazione trasparente.

Suspension lamp. Frame in natural aluminium **AN** (RAL 9006) or chromed **CR** finish. Reflector with white painted interior. Stainless steel suspension cable. Transparent power cable.

Suspension. Structure en aluminium naturel **AN** (RAL 9006) ou chromé **CR**. Réflecteur peint en blanc à l'intérieur. Câble de suspension en acier inox. Câble d'alimentation transparent.

Hängeleuchte. Gestell aus natürlichem Aluminium **AN** (RAL 9006) oder verchromt **CR**. Reflektor innen weiß lackiert. Aufhängekabel aus Edelstahl. Transparentes Netzkabel.

Lámpara de techo. Montura de aluminio natural **AN** (RAL 9006) o cromado **CR**. Reflector pintado blanco en el interior. Cable de suspensión de acero inoxidable. Cable de alimentación transparente.

lampadine / bulbs / ampoules / Glühbirnen / bombillas



IP20

Classe II



D-E

⦿ 1x105W (HA) Ⓢ E27

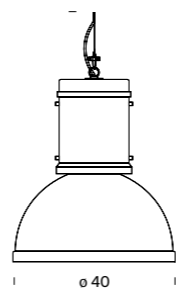

5000/2...

Lampada a sospensione. Montatura in alluminio naturale **AN** (RAL 9006) oppure cromato **CR**. Riflettore verniciato bianco all'interno. Cavo di sospensione in acciaio inox. Cavo di alimentazione trasparente.

Suspension lamp. Frame in natural aluminium **AN** (RAL 9006) or chromed **CR** finish. Reflector with white painted interior. Stainless steel suspension cable. Transparent power cable.

Suspension. Structure en aluminium naturel **AN** (RAL 9006) ou chromé **CR**. Réflecteur peint en blanc à l'intérieur. Câble de suspension en acier inox. Câble d'alimentation transparent.

Hängeleuchte. Gestell aus natürlichem Aluminium **AN** (RAL 9006) oder verchromt **CR**. Reflektor innen weiß lackiert. Aufhängekabel aus Edelstahl. Transparentes Netzkabel.

Lámpara de techo. Montura de aluminio natural **AN** (RAL 9006) o cromado **CR**. Reflector pintado blanco en el interior. Cable de suspensión de acero inoxidable. Cable de alimentación transparente.

lampadine / bulbs / ampoules / Glühbirnen / bombillas



IP20

Classe II



D-E

⦿ 1x140W (HA) Ⓢ E27

LOOP

pag. 180

Lampada da tavolo / Table lamp / Lampe de table / Tischleuchte / Lámpara de sobremesa

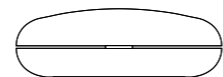

5429AXL

Lampada da tavolo. Struttura in acciaio inossidabile. Diffusione della luce mediante rotazione della parte superiore della struttura. Cavo di alimentazione, interruttore e spina trasparenti.

Table lamp. Stainless steel frame. Light diffusion through rotation of the upper part of the frame. Transparent power cable, switch and plug.

Lampe de table. Structure en acier inox. Diffusion de la lumière par rotation de la partie supérieure de la structure. Câble d'alimentation, interrupteur et fiche transparents.

Tischleuchte. Struktur aus rostfreiem Stahl. Lichtstreuung durch Drehen des oberen Teils der Struktur. Netzkabel, Schalter und Netzstecker transparent.

Lámpara de sobremesa. Estructura de acero inoxidable. Difusión de la luz mediante rotación de la parte superior de la estructura. Cable de alimentación, interruptor y enchufe transparentes.

lampadine / bulbs / ampoules / Glühbirnen / bombillas

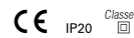

IP20

Classe II



A

⦿ 1x40W (FL) 2Gx13

LOUNGE

pag. 182

Lampada da parete / Wall lamp / Applique
Wandleuchte / Aplique

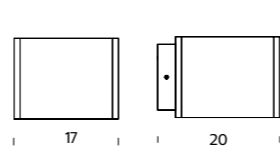

5400...

Lampada da parete. Montatura in metallo verniciato alluminio. Diffusore in metacrilato serigrafato arancione **AR** o trasparente **TR**. Schemo di chiusura, superiore e inferiore, in vetro sabbato.

Wall lamp. Aluminium-painted metal frame. Orange **AR** or transparent **TR** screen printed methacrylate diffuser. Upper and lower shields in sandblasted glass.

Applique. Structure en métal peint en couleur aluminium. Diffuseur en méthacrylate sérigraphié orange **AR** ou transparent **TR**. Écrans de fermeture, supérieure et inférieure, en verre sablé.

Wandleuchte. Gestell aus aluminiumfarbig lackiertem Metall. Diffusor aus bedrucktem Methacrylat orangefarben **AR** oder transparent **TR**. Obere und untere Abschlussblende aus sandgestrahltem Glas.

Lámpara de pared. Montura de metal pintado aluminio. Difusor de metacrilato serigrafado naranja **AR** o transparente **TR**. Pantalla de cierre, superior e inferior, de vidrio arenado.

lampadine / bulbs / ampoules / Glühbirnen / bombillas



IP20

Classe II



A-E

⦿ 1x150W (HA) Ⓢ E27 or

⦿ 1x20W (FL) E27

LUMEN

pag. 184

Lampada da terra / Floor lamp / Lampadaire
Stehleuchte / Lámpara de pie

IT	EN	FR	DE	ES	
2482	Lampada da terra con doppia dimmerazione. Montatura in metallo verniciato bianco. Diffusore in vetro soffiato bianco opalino satinato. Cavo di alimentazione, dimmer e spina neri.	Floor lamp with double dimmer. Metal frame in white finish. Diffuser in frosted white opaline blown glass. Black cable, dimmer and plug.	Lampadaire avec double variateur. Structure en métal peint en blanc. Diffuseur en verre soufflé blanc opalin satiné. Câble d'alimentation, variateur et fiche noirs.	Stehleuchte mit doppelter Dimmerfunktion. Gestell aus weiß lackiertem Metall. Diffusor aus weißem mundgeblasenem und satiniertem Opalglas. Netzkaabel, Dimmer und Netzstecker schwarz.	Lámpara de suelo con doble dimerización. Estructura de metal pintado blanco. Difusor de cristal soplado blanco opalino satinado. Cable de alimentación, dimmer y enchufe negro.

lampadine / bulbs / ampoules / Glühbirnen / bombillas



4x60W (HA) (E) E27 or
4x20W (FL) E27 +

1x100W (HA) (E) E27



LUMINATOR

pag. 186

Lampada da terra / Floor lamp / Lampadaire
Stehleuchte / Lámpara de pie

IT	EN	FR	DE	ES	
05560N	Lampada da terra con dimmer. Emissione di luce indiretta. Struttura in ottone nichelato. Cavo di alimentazione, dimmer e spina neri.	Floor lamp with dimmer. Indirect light emission. Nickel-plated brass finish. Black power cable, dimmer and plug.	Lampadaire avec variateur. Émission de lumière indirecte. Structure en laiton nickelé. Câble d'alimentation, variateur et fiche noirs.	Stehleuchte mit Dimmer. Indirekte Lichtverteilung. Struktur aus vernickeltem Messing. Netzkaabel, Dimmer und Netzstecker schwarz.	Lámpara de pie con dimer. Emisión de luz indirecta. Estructura de latón niquelado. Cable de alimentación, dimer y enchufe negros.



lampadine / bulbs / ampoules / Glühbirnen / bombillas



1x230W (HA) (E) R7s/115

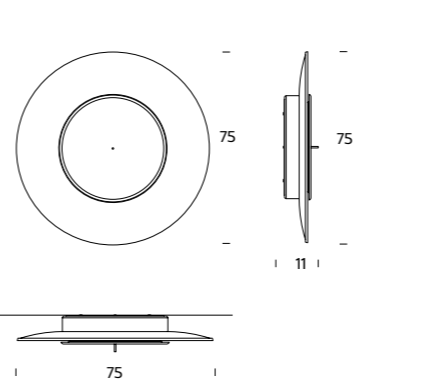

Lampada da parete e plafone / Wall and ceiling lamp / Applique ou plafonnier / Wand-order und Deckenleuchte / Aplique y plafón



IT	EN	FR	DE	ES
Lampada da parete e plafone. Riflettore e disco frontale in alluminio, disponibile con riflettore bianco e disco frontale bianco BI (RAL 9010), riflettore bianco e disco frontale nero N (RAL 9010/RAL 9005), riflettore alluminio lucidato e disco frontale nero AL , riflettore ricoperto foglia oro e disco frontale nero OO/N , riflettore ricoperto foglia oro e disco frontale ricoperto foglia rame OO/RM , riflettore ricoperto foglia rame e disco frontale nero RM/N , riflettore ricoperto foglia oro e disco frontale ricoperto foglia oro RM/OO , riflettore e disco frontale ricoperto foglia rame RM/RM .	Wall and ceiling lamp. Reflector and front disc in aluminum, available with white reflector and white front disc BI (RAL 9010), white reflector and black front disc N (RAL 9010/RAL 9005), polished aluminum reflector and black front disc AL , gold-leaf covered reflector and black front disc OO/N , gold-leaf covered reflector and copper-leaf covered front disc OO/RM , reflector and copper-leaf covered front disc OO/RM , copper-leaf covered reflector and black front disc RM/N , copper-leaf covered reflector and gold-leaf covered front disc RM/OO , copper-leaf covered reflector and front disc RM/RM .	Applique et plafonnier. Réflecteur et disque frontal en aluminium, disponible avec réflecteur blanc et disque frontal blanc BI (RAL 9010), réflecteur blanc et le disque frontal noir N (RAL 9010/RAL 9005), réflecteur aluminium poli et disque frontal noir AL , réflecteur revêtu de feuille d'or et disque frontal noir OO/N , réflecteur et disque frontal revêtus de feuille d'or OO/OO , réflecteur revêtu de feuille d'or et disque frontal de feuille de cuivre OO/RM , réflecteur revêtu de feuille de cuivre et disque frontal noir RM/N , réflecteur revêtu de feuille de cuivre et disque frontal de feuille d'or RM/OO , et réflecteur et disque frontal revêtus de feuille de cuivre RM/RM .	Wand- und Deckenleuchte. Reflektor und Frontscheibe aus Aluminium, erhältlich mit weißem Reflektor und weißer Frontscheibe BI (RAL 9010), weißem Reflektor und schwarzer Frontscheibe N (RAL 9010/RAL 9005), poliertem Aluminium-Reflektor und schwarzer Frontscheibe AL , Reflektor mit Blattgold und schwarzer Frontscheibe OO/N , Reflektor und Frontscheibe mit Blattgold OO/OO , Reflektor mit Blattgold und Frontscheibe mit Blattgold OO/OO , Reflektor mit Blattgold und schwarzer Frontscheibe RM/N , Reflektor mit Blattgold und Frontscheibe mit Blattgold RM/OO , Reflektor und Frontscheibe mit Blattgold RM/RM .	Lámpara de pared y plafón. Reflector y disco frontal de aluminio, disponible con reflector blanco y disco frontal blanco BI (RAL 9010), reflector blanco y disco frontal negro N (RAL 9010/RAL 9005), reflector aluminio pulido y disco frontal negro AL , reflector recubierto pan de oro y disco frontal negro OO/N , reflector recubierto pan de oro y disco frontal recubierto pan de oro OO/OO , reflector recubierto pan de oro y disco frontal recubierto pan de cobre OO/RM , reflector recubierto pan de cobre y disco frontal negro RM/N , reflector recubierto pan de cobre y disco frontal recubierto pan de oro RM/OO o reflector y disco frontal recubiertos pan de cobre RM/RM .

4246..

lampadine / bulbs / ampoules / Glühbirnen / bombillas



1x55W (FL) 2Gx13

4298..

lampadine / bulbs / ampoules / Glühbirnen / bombillas





LED - 28,6W (3000 K, CRI >80, 3650 Lm)

MANO

pag. 192

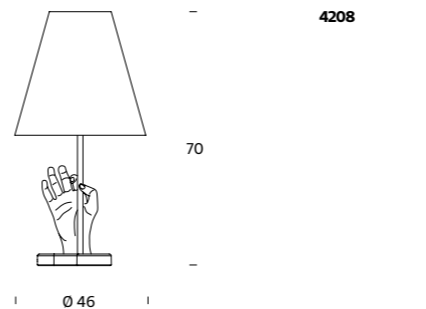
Lampada da tavolo / table lamp / lampe de table / Tischleuchte / lámpara de sobremesa

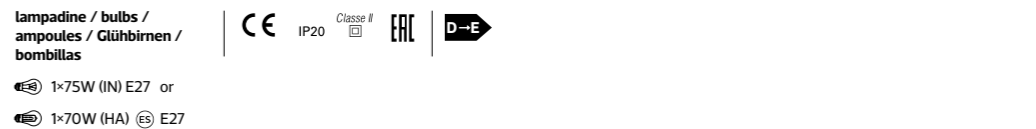

IT	EN	FR	DE	ES
Lampada da tavolo con dimmer. Base in polvere di marmo e resina e stelo in metallo a sezione quadrata, verniciati entrambi nero opaco "soft". Mano in polvere di marmo e resina colore bianco. Diffusore in tessuto nero accoppiato internamente a PVC bianco.	Table lamp with dimmer. Base of marble powder and resin and square section stem in metal, both painted "soft" black matte. Hand in white marble powder and resin. Diffuser in black fabric lined with white PVC.	Lampe de table avec variateur. Socle en poudre de marbre et résine, pied métallique à section carrée, tous deux laqués noir mat « soft ». Main en poudre de marbre et résine de couleur blanche. Diffuseur en tissu noir contrecollé et intérieur PVC blanc.	Tischleuchte mit Dimmer. Marmorpulver-/Harzbasis und viereckiger Metallstruktur, beide mit Softtouch-Lackierung mattschwarz. Marmorpulver-/Harzanstrich, weiß. Schwarzer Stoff-Diffusor, innen mit weißem PVC kombiniert.	Lámpara de sobremesa con dimer. Base en polvo de mármol y resina y pie de metal con sección cuadrada, ambos barnizados en negro mate «soft». Mano de polvo de mármol y resina de color blanco. Difusor de tejido negro acoplado internamente a PVC blanco.

lampadine / bulbs / ampoules / Glühbirnen / bombillas

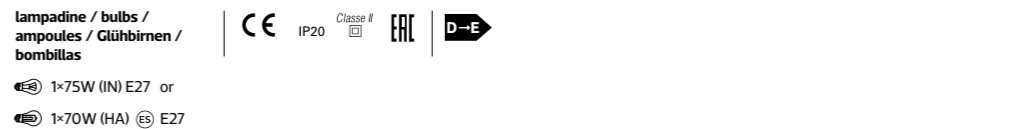

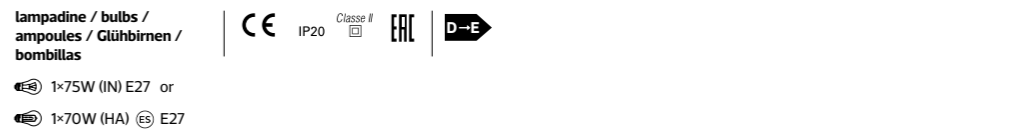
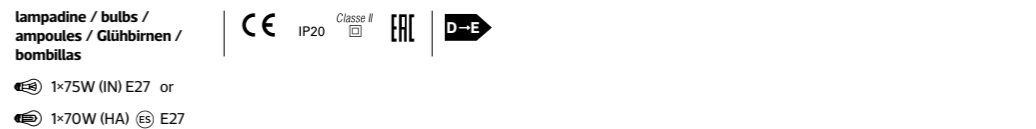
1x75W (IN) E27 or

1x70W (HA) (E) E27

MARGARET

pag. 196

Lampada da tavolo / Table lamp / Lampe de table / Tischleuchte / Lámpara de sobremesa

IT	EN	FR	DE	ES
 <p>5291..</p> <p>Lampada da appoggio (per spalliera letto, divano ecc.). Riflettore in alluminio brillantato e lucidato. Tige telescopica in ottone cromato. Sacca d'appoggio in pelle marrone MA oppure nera N. Cavo di alimentazione, interruttore e spina neri.</p>	<p>Side lamp with support sack (for hooking over a bedhead, sofa arm, etc.). Polished, buffed aluminium reflector. Chrome-plated brass telescopic stem. Brown MA or black N leather support sack. Black power cable, plug and switch.</p>	<p>Lampe à poser (pour dossier de lit, canapé, etc.). Réflecteur en aluminium brillanté et poli. Tige télescopique en laiton chromé. Sac d'appui en peau marron MA ou noire N. Câble d'alimentation, fiche et interrupteur noirs.</p>	<p>Überwurfleuchte (für Rücken- und Armlehnen usw.). Reflektor aus poliertem und geschliffenem Aluminium. Teleskopstab aus verchromtem Messing. Stütztasche aus Leder in braun MA oder schwarz N. Netzkabel, Netzstecker und Schalter schwarz.</p>	<p>Lámpara de apoyo (para cabecera de cama, sofá etc.). Reflector de aluminio pulido y bruñido. Barra telescópica de latón cromado. Bolsa de apoyo de piel marrón MA o negra N. Cable de alimentación, enchufe e interruptor negros.</p>
<p>lampadine / bulbs / ampoules / Glühbirnen / bombillas</p> <p>1x9W (FL) E14</p> <p>CE IP20 Classe II ENEC A</p>				

MILANO 2015

pag. 200



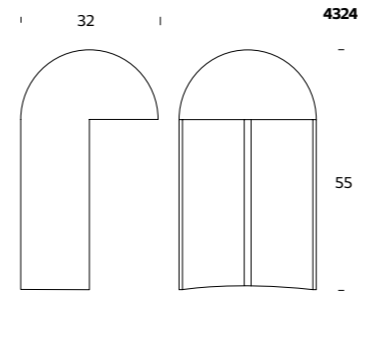

Lampada da tavolo / Table lamp / Lampe de table / Tischleuchte / Lámpara de sobremesa

IT	EN	FR	DE	ES
 <p>4324</p> <p>Lampada da tavolo. Corpo in marmo statuario di Carrara. Piastrina in alluminio satinato. Cavo di alimentazione rosso. Dimmer e spina colore nero.</p>	<p>Table lamp. Body in Carrara statue marble. Central plaque in satin aluminium. Red power cable. Black dimmer and plug. Electronic dimmer with built-in button control.</p>	<p>Lampe de table. Corps en marbre statuaire de Carrare. Bandeau vertical satiné. Câble rouge. Variateur et prise noirs.</p>	<p>Tischleuchte. Körper aus Statuario-Marmor aus Carrara. Mittige Leiste aus satiniertem Aluminium. Rotes Netzkabel. Dimmer und Stecker in schwarz.</p>	<p>Lampara de sobremesa. Cuerpo en mármol estatuario de Carrara. Placa de aluminio satinado. Cable rojo. Dimer y enchufe negros.</p>
<p>lampadine / bulbs / ampoules / Glühbirnen / bombillas</p> <p>LED - 17,5W (3000 K, CRI >80, 1300 Lm)</p> <p>CE IP20 Classe II INCL. LED NOT REPLACEABLE</p>				

MARISTELLA

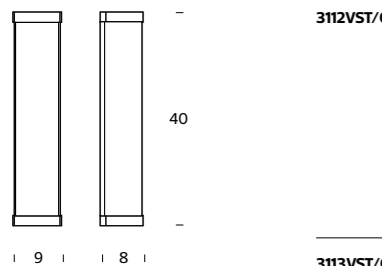
pag. 198

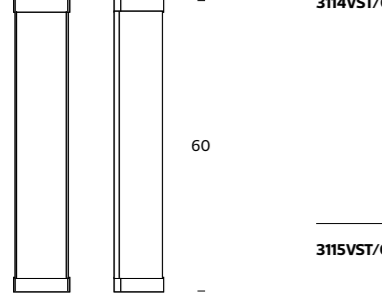
Lampada da parete / Wall lamp / Applique Wandleuchte / Applique

IT	EN	FR	DE	ES
 <p>3112VST/CR</p> <p>Lampada da parete. Montatura in metallo cromato. Diffusore in vetro stampato.</p>	<p>Wall lamp. Chromed metal frame. Pressed glass diffuser.</p>	<p>Applique. Structure en métal chromé. Diffuseur en verre moulé.</p>	<p>Wandleuchte. Gestell aus verchromtem Metall. Diffusor aus Pressglas.</p>	<p>Lámpara de pared. Montura de metal cromado. Difusor de vidrio grabado.</p>
<p>lampadine / bulbs / ampoules / Glühbirnen / bombillas</p> <p>1x24W (FL) 2G11</p> <p>CE IP44 ENEC A</p>				
 <p>3113VST/CR</p> <p>Lampada da parete. Montatura in metallo cromato. Diffusore in vetro stampato.</p>	<p>Wall lamp. Chromed metal frame. Pressed glass diffuser.</p>	<p>Applique. Structure en métal chromé. Diffuseur en verre moulé.</p>	<p>Wandleuchte. Gestell aus verchromtem Metall. Diffusor aus Pressglas.</p>	<p>Lámpara de pared. Montura de metal cromado. Difusor de vidrio grabado.</p>
<p>lampadine / bulbs / ampoules / Glühbirnen / bombillas</p> <p>2x40W (IN) E14 or 2x28W (HA) E14</p> <p>CE IP44 ENEC A-E</p>				
 <p>3114VST/CR</p> <p>Lampada da parete. Montatura in metallo cromato. Diffusore in vetro stampato.</p>	<p>Wall lamp. Chromed metal frame. Pressed glass diffuser.</p>	<p>Applique. Structure en métal chromé. Diffuseur en verre moulé.</p>	<p>Wandleuchte. Gestell aus verchromtem Metall. Diffusor aus Pressglas.</p>	<p>Lámpara de pared. Montura de metal cromado. Difusor de vidrio grabado.</p>
<p>lampadine / bulbs / ampoules / Glühbirnen / bombillas</p> <p>1x36W (FL) 2G11</p> <p>CE IP44 ENEC A</p>				
 <p>3115VST/CR</p> <p>Lampada da parete. Montatura in metallo cromato. Diffusore in vetro stampato.</p>	<p>Wall lamp. Chromed metal frame. Pressed glass diffuser.</p>	<p>Applique. Structure en métal chromé. Diffuseur en verre moulé.</p>	<p>Wandleuchte. Gestell aus verchromtem Metall. Diffusor aus Pressglas.</p>	<p>Lámpara de pared. Montura de metal cromado. Difusor de vidrio grabado.</p>
<p>lampadine / bulbs / ampoules / Glühbirnen / bombillas</p> <p>3x40W (IN) E14 or 3x28W (HA) E14</p> <p>CE IP44 ENEC A-E</p>				

NASKA 1, NASKA 2, NASKETTA

pag. 202

Lampada da tavolo, terra e parete / Table, floor and wall lamp / Lampe de table, lampadaire et applique / Tisch-, Steh- und Wandleuchte / Lámpara de sobremesa, pie y aplique

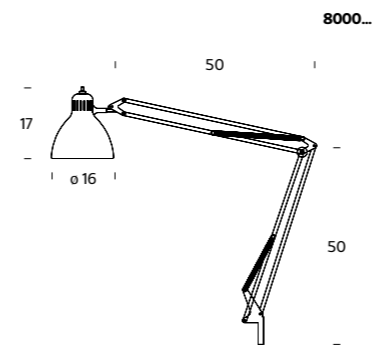
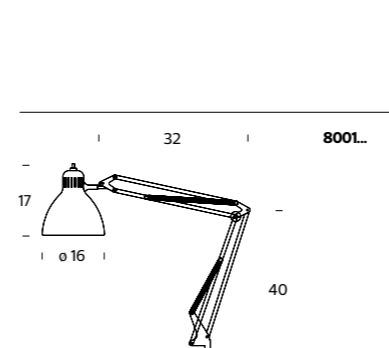
IT	EN	FR	DE	ES
 <p>8000..</p> <p>Famiglia di lampade da tavolo, terra e parete provvista di bracci orientabili in tutte le direzioni. Base e stelo in acciaio. Parabola in alluminio. Il tutto verniciato bianco BI (RAL 9003 opaco), nero NO (RAL 9005 opaco) o cromato CR. Cavo di alimentazione e spina colore nero.</p>	<p>A family of table, floor and wall lamps fitted with arms that can be moved in all directions. Base and stem in steel. Parabola in aluminium. All painted white BI (RAL 9003 matt), black NO (RAL 9005 matt) or chromed CR. Black power cable and plug.</p>	<p>Famille de lampes comprenant une lampe de table, un lampadaire et une applique munie d'un bras orientable dans toutes les directions. Base et tige en acier. Parabole en aluminium. L'ensemble est laqué blanc BI (RAL 9003 mate), noir NO (RAL 9005 mate) ou chromé CR. Câble d'alimentation et prise de couleur noire.</p>	<p>Lampenfamilie für Tisch, Boden und Wand mit in allen Richtungen orientierbaren Armen. Fuß und Stab aus Stahl. Parabel aus Aluminium. Das Ganze lackiert in Weiß BI (RAL 9003 matt), Schwarz N (RAL 9003 mate) oder verchromt CR. Netzkabel und -stecker in Schwarz.</p>	<p>Familia de lámparas de sobremesa, de pie y de pared provista de brazos orientales en todas las direcciones. Base y pie de acero. Parábola de aluminio. Todo pintado en blanco BI (RAL 9003 mate), negro NO (RAL 9005 mate), o cromado CR. Cable de alimentación y enchufe de color negro.</p>
<p>lampadine / bulbs / ampoules / Glühbirnen / bombillas</p> <p>1x60W (IN) E27 or 1x42W (HA) E27</p> <p>CE IP20 Classe II ENEC D-E</p>				
 <p>8001..</p> <p>Famiglia di lampade da tavolo, terra e parete provvista di bracci orientabili in tutte le direzioni. Base e stelo in acciaio. Parabola in alluminio. Il tutto verniciato bianco BI (RAL 9003 opaco), nero NO (RAL 9005 opaco) o cromato CR. Cavo di alimentazione e spina colore nero.</p>	<p>A family of table, floor and wall lamps fitted with arms that can be moved in all directions. Base and stem in steel. Parabola in aluminium. All painted white BI (RAL 9003 matt), black NO (RAL 9005 matt) or chromed CR. Black power cable and plug.</p>	<p>Famille de lampes comprenant une lampe de table, un lampadaire et une applique munie d'un bras orientable dans toutes les directions. Base et tige en acier. Parabole en aluminium. L'ensemble est laqué blanc BI (RAL 9003 mate), noir NO (RAL 9005 mate), ou chromé CR. Câble d'alimentation et prise de couleur noire.</p>	<p>Lampenfamilie für Tisch, Boden und Wand mit in allen Richtungen orientierbaren Armen. Fuß und Stab aus Stahl. Parabel aus Aluminium. Das Ganze lackiert in Weiß BI (RAL 9003 matt), Schwarz N (RAL 9003 mate) oder verchromt CR. Netzkabel und -stecker in Schwarz.</p>	<p>Familia de lámparas de sobremesa, de pie y de pared provista de brazos orientales en todas las direcciones. Base y pie de acero. Parábola de aluminio. Todo pintado en blanco BI (RAL 9003 mate), negro NO (RAL 9005 mate), o cromado CR. Cable de alimentación y enchufe de color negro.</p>
<p>lampadine / bulbs / ampoules / Glühbirnen / bombillas</p> <p>1x60W (IN) E27 or 1x42W (HA) E27</p> <p>CE IP20 Classe II ENEC D-E</p>				

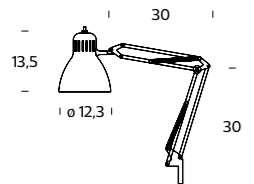
IT	EN	FR	DE	ES	
 <p>8004...</p>	<p>Famiglia di lampade da tavolo, terra e parete provvista di bracci orientabili in tutte le direzioni. Base e stelo in acciaio. Parabola in alluminio. Il tutto verniciato bianco BI (RAL 9003 opaco), nero NO (RAL 9005 opaco) o cromato CR. Cavo di alimentazione e spina colore nero.</p>	<p>A family of table, floor and wall lamps fitted with arms that can be moved in all directions. Base and stem in steel. Parabola in aluminum. All painted white BI (RAL 9003 matt), black NO (RAL 9005 matt) or chromed CR. Black power cable and plug.</p>	<p>Famille de lampes comprenant une lampe de table, un lampadaire et une applique munie d'un bras orientable dans toutes les directions. Base et tige en acier. Parabole en aluminium. L'ensemble est laqué blanc BI (RAL 9003 mate), noir NO (RAL 9005 mate), ou chromé CR. Câble d'alimentation et fiche de couleur noire.</p>	<p>Lampenfamilie für Tisch, Boden und Wand mit in allen Richtungen orientierbaren Armen. Fuß und Stab aus Stahl. Parabel aus Aluminium. Das Ganze lackiert in Weiß BI (RAL 9003 matt), Schwarz N (RAL 9005 matt) oder verchromt CR. Netzkabel und -stecker in Schwarz.</p>	<p>Familia de lámparas de sobremesa, de pie y de pared provista de brazos orientales en todas las direcciones. Base y pie de acero. Parabola de aluminio. Todo pintado en blanco BI (RAL 9003 mate), negro NO (RAL 9005 mate), o cromado CR. Cable de alimentación y enchufe de color negro.</p>

lampadine / bulbs / ampoules / Glühbirnen / bombillas

 IP20
 



 1x40W (IN) E27 or
 1x28W (HA)  E27

Accessori / Accessories / Accessoires
Zubehör / Accesorios

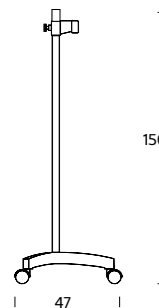
 <p>8100...</p>	<p>Base tavolo per 8000... e 8001...</p>	<p>Table base for 8000... and 8001...</p>	<p>Base pour table pour 8000... et 8001...</p>	<p>Socket für Tisch für 8000... und 8001...</p>	<p>Base para mesa para 8000... y 8001...</p>
 <p>8107...</p>	<p>Base tavolo per 8004...</p>	<p>Table base for 8004...</p>	<p>Base pour table pour 8004...</p>	<p>Socket für Tisch für 8004...</p>	<p>Base para mesa para 8004...</p>
 <p>8101...</p>	<p>Morsetto</p>	<p>Clamp</p>	<p>Étau</p>	<p>Klemme</p>	<p>Mordaza</p>
 <p>8104...</p>	<p>Attacco fisso</p>	<p>Fixed clamp</p>	<p>Attache fixe</p>	<p>Fester Sockel</p>	<p>Soporte fijo</p>
 <p>8105...</p>	<p>Base terra e stelo</p>	<p>Floor base and stem</p>	<p>Base lampadaire et tige</p>	<p>Bodenbasis und Stiel</p>	<p>Base de suelo y pie</p>
 <p>8103...</p>	<p>Supporto a parete</p>	<p>Wall support</p>	<p>Support mural</p>	<p>Wandsoclel</p>	<p>Soporte mural</p>

Lampada da terra / Floor lamp / Lampadaire
Stehleuchte / Lámpara de pie

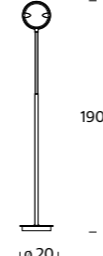
 <p>3026...</p>	<p>Lampada da terra con dimmer. Montatura in metallo cromato CR, nichelato satinato NS oppure bianco BI (RAL 9003 opaco). Diffusori orientabili in vetro satinato e riflettore per emissione di luce indiretta in alluminio. Cavo di alimentazione, dimmer e spina neri.</p>	<p>Floor lamp with dimmer. Metal frame in chromed CR, nickel-plated NS or white BI (RAL 9003 matt) finishes. Adjustable diffusers in frosted glass and aluminium reflector for indirect beam. Black power cable, dimmer and plug.</p>	<p>Lampadaire avec variateur. Structure en métal chromé CR, nickelé satiné NS ou blanc BI (RAL 9003 mate). Diffuseurs orientables en verre satiné et réflecteur en aluminium pour l'émission de la lumière indirecte. Câble d'alimentation, variateur et fiche noirs.</p>	<p>Stehlampe mit Dimmer. Gestell aus Metall, verchromt CR, satiniert vernickelt NS oder weißem BI (RAL 9003 matt). Mit orientierbaren Diffusoren aus satiniertem Glas und Aluminium-Reflektor für indirekte Lichtausstrahlung. Netzkabel, Dimmer und Netzstecker schwarz.</p>	<p>Lámpara de pie con dimmer. Montura de metal cromado CR, niquelado satinado NS o blanco BI (RAL 9003 mate). Difusores orientables de vidrio satinado y reflector para emisión de luz indirecta de aluminio. Cable de alimentación, dimer y enchufe negros.</p>
-----------------------------------------------------------------------------------------------------------	---------------------------------------------------------------------------------------------------------------------------------------------------------------------------------------------------------------------------------------------------------------------------------------------------	------------------------------------------------------------------------------------------------------------------------------------------------------------------------------------------------------------------------------------------------------------	------------------------------------------------------------------------------------------------------------------------------------------------------------------------------------------------------------------------------------------------------------------------------------------------	----------------------------------------------------------------------------------------------------------------------------------------------------------------------------------------------------------------------------------------------------------------------------------------------------	---------------------------------------------------------------------------------------------------------------------------------------------------------------------------------------------------------------------------------------------------------------------------------------

lampadine / bulbs / ampoules / Glühbirnen / bombillas

 IP40
 

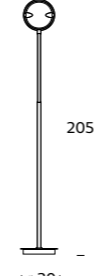

 1x120W (HA)  R7s/80

 <p>3392...</p>	<p>Lampada da terra con dimmer. Montatura in metallo cromato CR, nichelato satinato NS oppure bianco BI (RAL 9003 opaco). Diffusori orientabili in vetro satinato e riflettore per emissione di luce indiretta in alluminio. Cavo di alimentazione, dimmer e spina neri.</p>	<p>Floor lamp with dimmer. Metal frame in chromed CR, nickel-plated NS or white BI (RAL 9003 matt) finishes. Adjustable diffusers in frosted glass and aluminium reflector for indirect beam. Black power cable, dimmer and plug.</p>	<p>Lampadaire avec variateur. Structure en métal chromé CR, nickelé satiné NS ou blanc BI (RAL 9003 mate). Diffuseurs orientables en verre satiné et réflecteur en aluminium pour l'émission de la lumière indirecte. Câble d'alimentation, variateur et fiche noirs.</p>	<p>Stehlampe mit Dimmer. Gestell aus Metall, verchromt CR, satiniert vernickelt NS oder weißem BI (RAL 9003 matt). Mit orientierbaren Diffusoren aus satiniertem Glas und Aluminium-Reflektor für indirekte Lichtausstrahlung. Netzkabel, Dimmer und Netzstecker schwarz.</p>	<p>Lámpara de pie con dimmer. Montura de metal cromado CR, niquelado satinado NS o blanco BI (RAL 9003 mate). Difusores orientables de vidrio satinado y reflector para emisión de luz indirecta de aluminio. Cable de alimentación, dimer y enchufe negros.</p>
-----------------------------------------------------------------------------------------------------------	---------------------------------------------------------------------------------------------------------------------------------------------------------------------------------------------------------------------------------------------------------------------------------------------------	------------------------------------------------------------------------------------------------------------------------------------------------------------------------------------------------------------------------------------------------------------	------------------------------------------------------------------------------------------------------------------------------------------------------------------------------------------------------------------------------------------------------------------------------------------------	----------------------------------------------------------------------------------------------------------------------------------------------------------------------------------------------------------------------------------------------------------------------------------------------------	---------------------------------------------------------------------------------------------------------------------------------------------------------------------------------------------------------------------------------------------------------------------------------------

lampadine / bulbs / ampoules / Glühbirnen / bombillas

 IP40
 



 1x230W (HA)  R7s/80

Lampada da parete / Wall lamp / Applique
Wandleuchte / aAplique

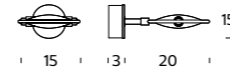
 <p>3023...</p>	<p>Lampada da parete. Montatura in metallo bianco opaco BI (RAL 9003 opaco), cromato CR oppure nichelato satinato NS. Diffusori in vetro satinato. È previsto un riflettore in alluminio anodizzato per luce indiretta e un distanziatore per connessioni elettriche. CAT.. BI - CR - NS distanziatore (ricambio)</p>	<p>Wall lamp. Matte white BI (RAL 9003 matt), chromed CR or nickel-plated satiné NS metal frame. Frosted glass diffusers. Anodized aluminium reflectors for indirect beam and spacer for electrical connections are also available. CAT.. BI - CR - NS spacer (spare part)</p>	<p>Applique. Structure en métal blanc opaque BI (RAL 9003 mate), chromé CR ou nickelé satiné NS. Diffuseurs en verre satiné. Il est prévu un réflecteur en aluminium anodisé pour la lumière indirecte et une entretoise pour les connexions électriques. CAT.. BI - CR - NS entretoise (pièce de rechange)</p>	<p>Wandleuchte. Gestell aus Metall matt weiß BI (RAL 9003 matt), verchromt CR oder satiniert vernickelt NS. Diffusoren aus satiniertem Glas. Reflektor aus eloxiertem Aluminium für indirekte Beleuchtung und Distanzstück für elektrische Anschlüsse erhältlich. CAT.. BI - CR - NS Distanzstück (Ersatzteil)</p>	<p>Lámpara de pared. Montura de metal blanco mate BI (RAL 9003 mate), cromado CR o niquelado satinado NS. Difusores de vidrio satinado. Está equipada con un reflector de aluminio anodizado para luz indirecta y con un distanciador para conexiones eléctricas. CAT.. BI - CR - NS distanciador (pieza de recambio)</p>
-------------------------------------------------------------------------------------------------------------	---------------------------------------------------------------------------------------------------------------------------------------------------------------------------------------------------------------------------------------------------------------------------------------------------------------------------------------------------	------------------------------------------------------------------------------------------------------------------------------------------------------------------------------------------------------------------------------------------------------------------------------------------------------------	---------------------------------------------------------------------------------------------------------------------------------------------------------------------------------------------------------------------------------------------------------------------------------------------------------------------------------------------	------------------------------------------------------------------------------------------------------------------------------------------------------------------------------------------------------------------------------------------------------------------------------------------------------------------------------------------------	-------------------------------------------------------------------------------------------------------------------------------------------------------------------------------------------------------------------------------------------------------------------------------------------------------------------------------------------------------

lampadine / bulbs / ampoules / Glühbirnen / bombillas

 IP40
 



 1x120W (HA)  R7s/80

Lampada da parete / Wall lamp / Applique
Wandleuchte / aApplique

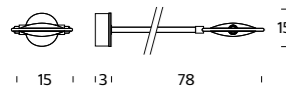

3023/1...

Lampada da parete. Montatura in metallo cromato **CR** oppure nichelato satinato **NS**. Diffusori in vetro satinato. È previsto un riflettore in alluminio anodizzato per luce indiretta e un distanziatore per connessioni elettriche.
CAT. CR - NS distanziatore (ricambio)

Wall lamp. Matte chromed **CR** or nickel-plated satined **NS** metal frame. Frosted glass diffusers. Anodized aluminium reflectors for indirect beam and spacer for electrical connections are also available.
CAT. CR - NS spacer (spare part)

Applique. Structure en métal chromé **CR** ou nickelé satiné **NS**. Diffuseurs en verre satiné. Il est prévu un réflecteur en aluminium anodisé pour la lumière indirecte et une entretoise pour les connexions électriques.
CAT. CR - NS entretoise (pièce de rechange)

Wandleuchte. Gestell aus Metall verchromt **CR** oder satiniert vernickelt **NS**. Diffusoren aus satiniertem Glas. Reflektor aus eloxiertem Aluminium für indirekte Beleuchtung und Distanzstück für elektrische Anschlüsse erhältlich.

Lámpara de pared. Montura de metal cromado **CR** o niquelado satinado **NS**. Difusores de vidrio satinado. Está equipada con un reflector de aluminio anodizado para luz indirecta y con un distanciador para conexiones eléctricas.
CAT. CR - NS distanciador (pieza de recambio)

lampadine / bulbs / ampoules / Glühbirnen / bombillas



↔ 1×120W (HA) Ⓡ R7s/80

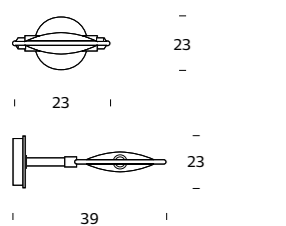

3356...

Lampada da parete. Montatura in metallo cromato **CR** oppure nichelato satinato **NS**. Diffusori in vetro satinato. È previsto un riflettore in alluminio anodizzato per luce indiretta e un distanziatore per connessioni elettriche.

Wall lamp. Matte chromed **CR** or nickel-plated satined **NS** metal frame. Frosted glass diffusers. Anodized aluminium reflectors for indirect beam and spacer for electrical connections are also available.

Applique. Structure en métal chromé **CR** ou nickelé satiné **NS**. Diffuseurs en verre satiné. Il est prévu un réflecteur en aluminium anodisé pour la lumière indirecte et une entretoise pour les connexions électriques.

Wandleuchte. Gestell aus Metall verchromt **CR** oder satiniert vernickelt **NS**. Diffusoren aus satiniertem Glas. Reflektor aus eloxiertem Aluminium für indirekte Beleuchtung und Distanzstück für elektrische Anschlüsse erhältlich.

Lámpara de pared. Montura de metal cromado **CR** o niquelado satinado **NS**. Difusores de vidrio satinado. Está equipada con un reflector de aluminio anodizado para luz indirecta y con un distanciador para conexiones eléctricas.

lampadine / bulbs / ampoules / Glühbirnen / bombillas



↔ 1×230W (HA) R7s/115

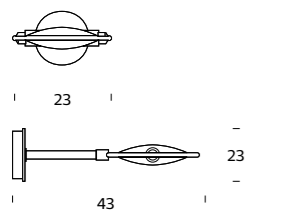

3356/1...

Lampada da parete. Montatura in metallo cromato **CR** oppure nichelato satinato **NS**. Diffusori in vetro satinato. È previsto un riflettore in alluminio anodizzato per luce indiretta e un distanziatore per connessioni elettriche.

Wall lamp. Matte chromed **CR** or nickel-plated satined **NS** metal frame. Frosted glass diffusers. Anodized aluminium reflectors for indirect beam and spacer for electrical connections are also available.

Applique. Structure en métal chromé **CR** ou nickelé satiné **NS**. Diffuseurs en verre satiné. Il est prévu un réflecteur en aluminium anodisé pour la lumière indirecte et une entretoise pour les connexions électriques.

Wandleuchte. Gestell aus Metall verchromt **CR** oder satiniert vernickelt **NS**. Diffusoren aus satiniertem Glas. Reflektor aus eloxiertem Aluminium für indirekte Beleuchtung und Distanzstück für elektrische Anschlüsse erhältlich.

Lámpara de pared. Montura de metal cromado **CR** o niquelado satinado **NS**. Difusores de vidrio satinado. Está equipada con un reflector de aluminio anodizado para luz indirecta y con un distanciador para conexiones eléctricas.

lampadine / bulbs / ampoules / Glühbirnen / bombillas



↔ 1×70W (MH) Rx7s

Lampada a sospensione / Suspension lamp
Suspension / Pendelleuchte / Suspensión

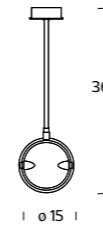

3022...

Lampada a sospensione. Montatura in metallo bianco opaco **BI** (RAL 9003 opaco), cromato **CR** oppure nichelato satinato **NS**. Diffusori in vetro satinato. È previsto un riflettore in alluminio anodizzato per luce indiretta e un distanziatore per connessioni elettriche.

Suspension lamp. Matte white **BI** (RAL 9003 matt), chromed **CR** or nickel-plated satined **NS** metal frame. Frosted glass diffusers. Anodized aluminium reflectors for indirect beam and spacer for electrical connections are also available.

Suspension. Structure en métal blanc opaque **BI** (RAL 9003 mate), chromé **CR** ou nickelé satiné **NS**. Diffuseurs en verre satiné. Il est prévu un réflecteur en aluminium anodisé pour la lumière indirecte et une entretoise pour les connexions électriques.

Hängelampe. Gestell aus Metall matt weiß **BI** (RAL 9003 mate), verchromt **CR** oder satiniert vernickelt **NS**. Diffusoren aus satiniertem Glas. Reflektor aus eloxiertem Aluminium für indirekte Beleuchtung und Distanzstück für elektrische Anschlüsse erhältlich.

Lámpara de techo. Montura de metal blanco mate **BI** (RAL 9003 mate), cromado **CR** o niquelado satinado **NS**. Difusores de vidrio satinado. Está equipada con un reflector de aluminio anodizado para luz indirecta y con un distanciador para conexiones eléctricas.

lampadine / bulbs / ampoules / Glühbirnen / bombillas



↔ 1×120W (HA) Ⓡ R7s/80

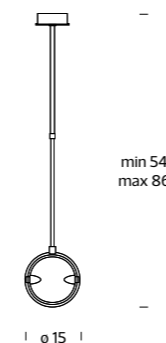

3085...

Lampada a sospensione. Montatura in metallo cromato **CR** oppure nichelato satinato **NS**. La lampada è fornita con riflettore in alluminio anodizzato per luce indiretta e diffusori in vetro stampato, temperato e sabbiato. Scatola distanziale inclusa. Il modello è provvisto di tige telescopica.

Suspension lamp. Metal frame in chromed **CR** finish, or satined nickel plating **NS**. The lamp fits an anodized aluminium reflector for indirect beam and pressed sandblasted tempered glass diffusers. Spacer box included. Provided with telescopic stem.

Suspension. Structure en métal chromé **CR** ou nickelé satiné **NS**. La lampe est équipée d'un réflecteur en aluminium anodisé pour la lumière indirecte et de diffuseurs en verre moulé, trempé et sablé. Boîte d'entretoise incluse. Avec tige télescopique.

Hängelampe. Gestell aus Metall, verchromt **CR** oder vernickelt satiniert **NS**. Die Lampe wird mit einem Reflektor aus eloxiertem Aluminium für indirektes Licht und mit Diffusoren aus sandgestrahltem Pressglas geliefert. Distanzstückgehäuse unbegriffen. Mit Teleskopstange.

Lámpara de techo. Montura de metal cromado **CR**, o niquelada satinada **NS**. La lámpara está equipada con reflector de aluminio anodizado para luz indirecta y difusores de vidrio grabado, templado y arenado. Con barra telescópica.

lampadine / bulbs / ampoules / Glühbirnen / bombillas



↔ 1×120W (HA) Ⓡ R7s/80

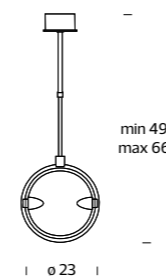

3358...

Lampada a sospensione. Montatura in metallo cromato **CR** oppure nichelato satinato **NS**. La lampada è fornita con riflettore in alluminio anodizzato per luce indiretta e diffusori in vetro stampato, temperato e sabbiato. Scatola distanziale inclusa. Il modello è provvisto di tige telescopica.

Suspension lamp. Metal frame in chromed **CR** finish, or satined nickel plating **NS**. The lamp fits an anodized aluminium reflector for indirect beam and pressed sandblasted tempered glass diffusers. Spacer box included. Provided with telescopic stem.

Suspension. Structure en métal chromé **CR** ou nickelé satiné **NS**. La lampe est équipée d'un réflecteur en aluminium anodisé pour la lumière indirecte et de diffuseurs en verre moulé, trempé et sablé. Boîte d'entretoise incluse. Avec tige télescopique.

Hängelampe. Gestell aus Metall, verchromt **CR** oder vernickelt satiniert **NS**. Die Lampe wird mit einem Reflektor aus eloxiertem Aluminium für indirektes Licht und mit Diffusoren aus sandgestrahltem Pressglas geliefert. Distanzstückgehäuse unbegriffen. Mit Teleskopstange.

Lámpara de techo. Montura de metal cromado **CR**, o niquelada satinada **NS**. La lámpara está equipada con reflector de aluminio anodizado para luz indirecta y difusores de vidrio grabado, templado y arenado. Con barra telescópica.

lampadine / bulbs / ampoules / Glühbirnen / bombillas



↔ 1×230W (HA) Ⓡ R7s/115

NOBI 2

pag. 212

Lampada da parete / Wall lamp / Applique / Wandleuchte / Applique

IT	EN	FR	DE	ES
<p>3595...</p> <p>Lampada da parete. Montatura in metallo cromato CR oppure nichelato satinato NS. Diffusori in vetro satinato. Distanziatore per connessioni elettriche incluso. riflettore in alluminio anodizzato</p>	<p>Wall lamp. Frame in chromed CR or nickel-plated satiné NS metal. Frosted glass diffusers. Includes spacer for electrical connection.</p> <p>R30865 anodized aluminium reflector</p>	<p>Applique. Structure en métal chromé CR ou nickelé satiné NS. Diffuseurs en verre satiné. Entretoise pour connexions électriques incluse.</p> <p>R30865 réflecteur en aluminium anodisé</p>	<p>Wandleuchte. Gestell aus Metall verchromt CR oder satiniert vernickelt NS. Diffusoren aus satiniertem Glas. Distanzstück für elektrische Anschlüsse inbegriffen.</p> <p>R30865 Reflektor aus eloxiertem Aluminium</p>	<p>Lámpara de pared. Montura de metal cromado CR o niquelado satinado NS. Difusores de vidrio satinado. Distanciador para conexiones eléctricas incluido.</p> <p>R30865 reflector de aluminio anodizado</p>
<p>lampadine / bulbs / ampoules / Glühbirnen / bombillas</p> <p>↔ 2×120W (HA) Ⓢ R7s/80</p> <p>CE IP40 EAC C→E INCL. C</p>				

Lampada a sospensione / Suspension lamp / Suspension / Pendelleuchte / Suspensión

IT	EN	FR	DE	ES
<p>3596...</p> <p>Lampada a sospensione. Montatura con bracci orientabili in metallo cromato CR o nichelato satinato NS. Diffusori orientabili in vetro stampato, sabbaiato e temperato. Distanziatore incluso. I diffusori possono essere posizionati orizzontalmente oppure verticalmente. R30865 riflettore in alluminio anodizzato</p>	<p>Suspension lamp. Metal frame with pivoting arms, in chromed CR or satiné nickel plating NS. Spacer included. Adjustable diffusers in pressed sandblasted tempered glass can be positioned horizontally or vertically.</p> <p>R30865 anodized aluminium reflector</p>	<p>Suspension. Structure à bras orientables en métal chromé CR ou nickelé satiné NS. Diffuseurs orientables en verre moulé, sablé et trempé. Entretoise incluse. Les diffuseurs peuvent être placés horizontalement ou verticalement.</p> <p>R30865 réflecteur en aluminium anodisé</p>	<p>Hängeleuchte. Gestell mit schwenkbaren Armen aus Metall, verchromt CR oder vernickelt satiniert NS. Schwenkbare Diffusoren aus getempertem und sandgestrahltem Pressglas. Distanzstück inbegriffen. Die Diffusoren können horizontal oder vertikal angeordnet sein.</p> <p>R30865 Reflektor aus eloxiertem Aluminium</p>	<p>Lámpara de techo. Montura con brazos orientables de metal cromado CR o niquelado satinado NS. Difusores orientables de vidrio grabado, arenado, y templado. Distanciador incluido. Los difusores pueden colocarse en dirección horizontal o vertical.</p> <p>R30865 reflector de aluminio anodizado</p>
<p>lampadine / bulbs / ampoules / Glühbirnen / bombillas</p> <p>↔ 2×120W (HA) Ⓢ R7s/80</p> <p>CE IP40 EAC C→E INCL. C</p>				

NOBI 4

pag. 216

Lampada da terra / Floor lamp / Lampadaire / Stehleuchte / Lámpara de pie

IT	EN	FR	DE	ES
<p>3599..</p> <p>Lampada da terra con doppia dimmerazione. Montatura in metallo cromato CR o nichelato satinato NS. Diffusori in vetro satinato. L'attacco porta-diffusori può essere posizionato in senso orizzontale o verticale. Cavo di alimentazione, dimmer e spina neri.</p>	<p>Floor lamp with double dimmer. Metal frame in chromed CR satiné nickel-plated NS finishes. Diffusers in frosted glass. The diffuser mount can be positioned horizontally or vertically. Black power cable, dimmer and plug.</p>	<p>Lampadaire avec double variateur. Structure en métal chromé CR ou nickelé satiné NS. Diffuseurs en verre satiné. La fixation porte-diffuseurs peut être placée horizontalement ou verticalement. Câble d'alimentation, variateur et fiche noirs.</p>	<p>Stehleuchte mit doppelter Dimmerfunktion. Metallgestell verchromt CR satiniert vernickelt NS. Diffusoren aus satiniertem Glas. Der Halter der Diffusoren kann wahlweise horizontal oder vertikal positioniert werden. Netzkabel, Dimmer und Netzstecker schwarz.</p>	<p>Lámpara de pie con doble regulación de la intensidad luminosa. Montura de metal cromado CR, niquelado satinado NS. Difusores de vidrio satinado. El soporte de los difusores puede colocarse en dirección horizontal o vertical. Cable de alimentación, dimer y enchufe negros.</p>
<p>lampadine / bulbs / ampoules / Glühbirnen / bombillas</p> <p>↔ 4×120W (HA) Ⓢ R7s/80</p> <p>CE IP20 Classe II EAC C→E INCL. C</p>				

NUOVA SEGNO TRE

pag. 218

Lampada da terra / Floor lamp / Lampadaire / Stehleuchte / Lámpara de pie

IT	EN	FR	DE	ES
<p>M2688...+ V2686-88BI</p> <p>Lampada da terra con dimmer. Montatura in metallo verniciato grigio chiaro GC oppure cromato CR. Conetto diffusore in vetro bianco. Cavo di alimentazione, dimmer e spina neri. M2688... CR - GC montatura V2686-88BI conetto</p>	<p>Floor lamp with dimmer. Metal frame with light grey GC or chromed CR finish. White glass diffuser cone. Black power cable, dimmer and plug.</p> <p>M2688... CR - GC frame V2686-88BI cone</p>	<p>Lampadaire avec variateur. Structure en métal peint en gris clair GC ou chromé CR. Cône diffuseur en verre blanc. Câble d'alimentation, variateur et fiche noirs.</p> <p>M2688... CR - GC structure V2686-88BI cône</p>	<p>Stehleuchte mit Dimmer. Metallgestell hellgrau lackiert GC oder verchromt CR. Kegeldiffusor aus weißem Glas. Netzkabel, Dimmer und Netzstecker schwarz.</p> <p>M2688... CR - GC Gestell V2686-88BI Kegel</p>	<p>Lámpara de pie con dimer. Montura de metal pintado gris claro GC o cromado CR. Cono difusor de vidrio blanco. Cable de alimentación, dimer y enchufe negros.</p> <p>M2688... CR - GC montura V2686-88BI cono</p>
<p>lampadine / bulbs / ampoules / Glühbirnen / bombillas</p> <p>↔ 1×150W (HA) Ⓢ B15d</p> <p>CE IP20 Classe II EAC D→E INCL. D</p>				

ODEON

pag. 220

Lampada da terra / Floor lamp / Lampadaire / Stehleuchte / Lámpara de pie

IT	EN	FR	DE	ES
<p>4255...</p> <p>Lampada da terra. Diffusore in policarbonato opalino bianco latte. Struttura rivestita in cuoietto disponibile nelle varianti di colore arancio con cuciture nere AR, bianco con cuciture blu BI, color cognac con cuciture corda CU, testa di moro con cuciture marrone TM. Cavo di alimentazione e interruttore colore nero. Emissione di luce wall washer.</p>	<p>Floor lamp. Diffuser in milk white polycarbonate. Structure covered in cuoietto leather, available in the following colours: orange with black stitching AR, white with blue stitching BI, cognac with rope stitching CU and dark brown with brown stitching TM. Black power cable and switch. Wall washer light emission.</p>	<p>Lampadaire. Diffuseur en polycarbonate blanc laiteux opalin. Structure recouverte de cuir "cuoietto" disponible en coloris: orange avec coutures noires AR, blanc avec coutures bleues BI, cognac avec coutures corde CU, tête-de-Maure avec coutures marron TM. Câble d'alimentation et interrupteur de couleur noire. Émission de lumière lèche-mur.</p>	<p>Bodenleuchte. Diffusor aus opalweißem Polycarbonat. Struktur mit feiner Lederverkleidung, erhältlich in den Farben Orange mit schwarzen Nähten AR, Weiß mit blauen Nähten BI, Cognac mit Kordelnähten CU, Schokoladenbraun mit braunen Nähten TM. Netzkabel und Schalter schwarz. Wall Washer-Licht.</p>	<p>Lámpara de pie. Difusor de policarbonato opalino blanco leche. Estructura revestida en cuero cuoietto disponible en las variantes de color naranja con costuras negras AR, blanco con costuras azules BI, color coñac con costuras de colorcuerda CU o marrón oscuro con costuras marrones TM. Cable de alimentación e interruptor color negro. Emisión de luz con efecto baño de pared.</p>
<p>lampadine / bulbs / ampoules / Glühbirnen / bombillas</p> <p>↔ 1×33W (FL) E27</p> <p>CE IP20 EAC A</p>				



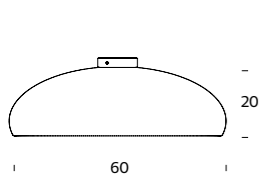

PANGEN

pag. 222

Lampada da plafone / Ceiling lamp / Plafonnier / Deckenleuchte / Pláfon



IT	EN	FR	DE	ES
Lampada da plafone. Corpo in alluminio verniciato bianco BI (RAL 9003 lucido) nero N (RAL 9005 lucido), rosso R (RAL 3004 lucido), verde V (RAL 6003 lucido) e arancio AR (RAL 2010 lucido). Schermo diffusore in policarbonato satinato. Attacco a plafone cromato.	Ceiling lamp. Body in white painted aluminum BI (RAL 9003 gloss), black N (RAL 9005 gloss), red R (RAL 3004 gloss), green V (RAL 6003 gloss) and orange AR (RAL 2010 gloss). The diffuser screen is in satin-finish polycarbonate. Chromed ceiling attachment.	Plafonnier. Corps en aluminium laqué blanc BI (RAL 9003 brillante), noir N (RAL 9005 brillante), rouge R (RAL 3004 brillante), vert V (RAL 6003 brillante) ou orange AR (RAL 2010 brillante). Écran diffuseur en polycarbonate satiné. Pavillon de recouvrement chromé.	Deckenleuchte. Aluminiumkörper lackiert weiß BI (RAL 9003 glänzend), schwarz N (RAL 9005 glänzend), rot R (RAL 3004 glänzend), grün V (RAL 6003 glänzend) und orange AR (RAL 2010 glänzend). Diffusor-Schirm aus satiniertem Polycarbonat. Deckenanschluss verchromt.	Lámpara plafón. Cuerpo de aluminio pintado blanco BI (RAL 9003 brillante), negro N (RAL 9005 brillante), rojo R (RAL 3004 brillante), verde V (RAL 6003 brillante) y naranja AR (RAL 2010 brillante). Pantalla difusora de policarbonato satinado. Conexión a plafón cromado.



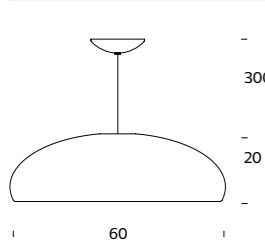

4197... **lampadine / bulbs / ampoules / Glühbirnen / bombillas**  IP20   
 3×42W max (HA/FL/LED) E27

4335... **lampadine / bulbs / ampoules / Glühbirnen / bombillas**  IP20 
 LED - 28,6W max (3000 K, CRI>80, 3650 Lm)

Lampada a sospensione / Suspension lamp / Suspension / Pendelleuchte / Suspensión



IT	EN	FR	DE	ES
Sospensione. Corpo in alluminio verniciato bianco BI (RAL 9003 lucido), nero N (RAL 9005 lucido), rosso R (RAL 3004 lucido), verde V (RAL 6003 lucido) e arancio AR (RAL 2010 lucido). Schermo diffusore in policarbonato satinato. Cavo di alimentazione trasparente. Rosone cromato.	Suspension lamp. Body in white painted aluminum BI (RAL 9003 gloss), black N (RAL 9005 gloss), red R (RAL 3004 gloss), green V (RAL 6003 gloss) and orange AR (RAL 2010 gloss). The diffuser screen is in satin-finish polycarbonate. Clear power cable. Chromed ceiling rose.	Suspension. Corps en aluminium laqué blanc BI (RAL 9003 brillante), noir N (RAL 9005 brillante), rouge R (RAL 3004 brillante), vert V (RAL 6003 brillante) ou orange AR (RAL 2010 brillante). Écran diffuseur en polycarbonate satiné. Câble d'alimentation transparent. Rosace chromée.	Pendelleuchte. Aluminiumkörper lackiert weiß BI (RAL 9003 glänzend), schwarz N (RAL 9005 glänzend), rot R (RAL 3004 glänzend), grün V (RAL 6003 glänzend) und orange AR (RAL 2010 glänzend). Diffusor-Schirm aus satiniertem Polycarbonat. Verchromte Rosette.	Lámpara de techo. Cuerpo de aluminio pintado blanco BI (RAL 9003 brillante), negro N (RAL 9005 brillante), rojo R (RAL 3004 brillante), verde V (RAL 6003 brillante) y naranja AR (RAL 2010 brillante). Pantalla difusora de policarbonato satinado. Cable de alimentación transparente. Florón cromado.

4196... **lampadine / bulbs / ampoules / Glühbirnen / bombillas**  IP20   
 3×42W max (HA/FL/LED) E27

4334... **lampadine / bulbs / ampoules / Glühbirnen / bombillas**  IP20 
 LED - 28,6W max (3000 K, CRI>80, 3650 Lm)

PAROLA, PAROLONA

pag. 226

Lampada da tavolo / Table lamp / Lampe de table / Tischleuchte / Lámpara de sobremesa

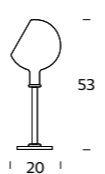

IT	EN	FR	DE	ES
M2658 + V2689... Lampada da tavolo con dimmer. Base in vetro trasparente con stelo in vetro borosilicato trasparente. Diffusore in vetro soffiato opalino ambra AM oppure bianco BI . Cavo di alimentazione tigrato, dimmer e interruttore neri.	Table lamp with dimmer. Transparent glass base with transparent borosilicate glass stem. Diffuser in amber AM or white BI opaline blown glass. Braided fabric cable, black dimmer and switch.	Lampe de table avec variateur. Base en verre transparent avec tige en verre borosilicate transparent. Diffuseur en verre soufflé opalin ambre AM ou blanc BI . Câble d'alimentation noir et blanc, variateur et interrupteur noirs.	Tischleuchte mit Dimmer. Fuß aus transparentem Glas mit Stiel aus transparentem Borosilikatglas. Diffusor aus mundgeblasenem Opalglas bernsteinfarben AM oder weiß BI . Netzkabel mit schwarz/weißer Textillumantelung. Dimmer und Schalter schwarz.	Lámpara de sobremesa con dimer. Base de vidrio transparente con pie de vidrio borosilicato transparente. Difusor de vidrio soplado opalino transparente. Cable revestido en tejido blanco y negro, dimer e interruptor negros.
M2658 base V2658... AM - BI diffusore	M2658 base V2658... AM - BI diffusor	M2658 base V2658... AM - BI diffusor	M2658 base V2658... AM - BI diffusor	M2658 base V2658... AM - BI difusor

lampadine / bulbs / ampoules / Glühbirnen / bombillas  IP20   
 1×150W (HA)  B15d

Lampada da terra / Floor lamp / Lampadaire Stehleuchte / Lámpara de pie

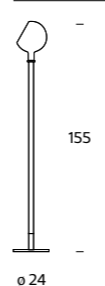

IT	EN	FR	DE	ES
M2659 + V2689... Lampada da terra con dimmer. Base in vetro trasparente molato. Stelo in vetro borosilicato. Diffusore in vetro soffiato opalino ambra AM o bianco BI . Cavo di alimentazione tigrato, dimmer e spina neri.	Floor lamp with dimmer. Transparent cut glass base. Borosilicate glass stem. Amber AM or white BI opaline blown glass diffuser. Braided black and white fabric cable, black dimmer and plug.	Lampadaire avec variateur. Base en verre transparent biseauté. Tige en verre borosilicate. Diffuseur en verre soufflé opalin, ambre AM ou blanc BI . Câble d'alimentation noir et blanc, variateur et fiche noirs.	Stehleuchte mit Dimmer. Sockel aus geschliffenem, transparentem Glas. Stiel aus Borosilikatglas. Diffusor aus mundgeblasenem Opalglas, bernstein AM oder weiß BI . Netzkabel mit schwarz/weißer Textillumantelung, Dimmer und Netzstecker schwarz.	Lámpara de pie con dimer. Base de vidrio transparente desbastado. Pie de vidrio borosilicato. Difusor de vidrio soplado opalino transparente. Cable revestido en tejido blanco y negro, dimer y enchufe negros.
M2659 base e stelo V2689... AM - BI diffusore	M2659 base and stem V2689... AM - BI diffusor	M2659 base et tige V2689... AM - BI diffuseur	M2659 Sockel und Stiel V2689... AM - BI Diffusor	M2659 base y pie V2689... AM - BI difusor

lampadine / bulbs / ampoules / Glühbirnen / bombillas  IP20   
 1×205W (HA)  B15d

Lampada da terra / Floor lamp / Lampadaire Stehleuchte / Lámpara de pie

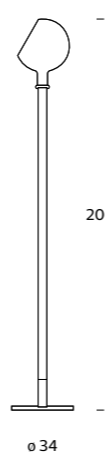

IT	EN	FR	DE	ES
M2751 + V2751... (PAROLONA) Lampada da terra con dimmer. Base in vetro trasparente molato. Stelo in vetro borosilicato. Diffusore in vetro soffiato opalino ambra AM o bianco BI . Cavo di alimentazione tigrato, dimmer e spina neri.	Floor lamp with dimmer. Transparent cut glass base. Borosilicate glass stem. Amber AM or white BI opaline blown glass diffuser. Braided black and white fabric cable, black dimmer and plug.	Lampadaire avec variateur. Base en verre transparent biseauté. Tige en verre borosilicate. Diffuseur en verre soufflé opalin, ambre AM ou blanc BI . Câble d'alimentation noir et blanc, variateur et fiche noirs.	Stehleuchte mit Dimmer. Sockel aus geschliffenem, transparentem Glas. Stiel aus Borosilikatglas. Diffusor aus mundgeblasenem Opalglas, bernstein AM oder weiß BI . Netzkabel mit schwarz/weißer Textillumantelung, Dimmer und Netzstecker schwarz.	Lámpara de pie con dimer. Base de vidrio transparente desbastado. Pie de vidrio borosilicato. Difusor de vidrio soplado opalino transparente. Cable revestido en tejido blanco y negro, dimer y enchufe negros.
M2751 base e stelo V2751... AM - BI diffusore	M2751 base and stem V2751... AM - BI diffusor	M2751 base et tige V2751... AM - BI diffuseur	M2751 Sockel und Stiel V2751... AM - BI Diffusor	M2751 base y pie V2751... AM - BI difusor

lampadine / bulbs / ampoules / Glühbirnen / bombillas  IP20   
 1×150W (HA)  B15d

Lampada da parete / Wall lamp / Applique / Wandleuchte / Applique

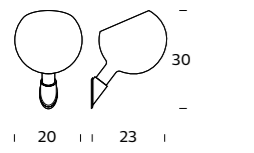
IT	EN	FR	DE	ES
 <p>M2689ON+V2689... Lampada da parete. Montatura in ottone nichelato. Diffusore in vetro soffiato opalino ambra AM oppure bianco BI. M2689ON montatura V2689... AM - BI diffusore</p>	<p>Wall lamp. Nickel-plated brass frame. Diffuser in amber AM or white BI opaline blown glass. M2689ON frame V2689... AM - BI diffuser</p>	<p>Applique. Structure en laiton nickelé. Diffuseur en verre soufflé opalin ambre AM ou blanc BI. M2689ON structure V2689... AM - BI diffuseur</p>	<p>Wandleuchte. Gestell aus vernickeltem Messing. Diffusor aus mundgeblasenem Opalglas. Farben: bernstein AM oder weiß BI. M2689ON Gestell V2689... AM - BI Diffusor</p>	<p>Lámpara de pared. Montura de latón niquelado. Difusor de vidrio soplado opalino ámbar AM o blanco BI. M2689ON montura V2689... AM - BI difusor</p>
<p>lampadine / bulbs / ampoules / Glühbirnen / bombillas</p> <p>CE IP20 ENEC ENEC D→E INCL. D</p> <p>1x150W (HA) E27 or 1x20W (FL) E27</p>				

Lampada a sospensione / Suspension lamp / Suspension / Pendelleuchte / Suspensión

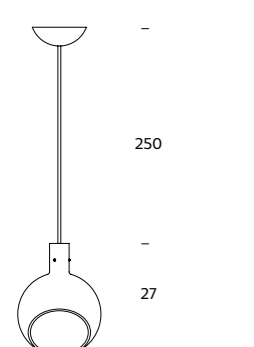
IT	EN	FR	DE	ES
 <p>4284... Sospensione. Diffusore in vetro soffiato opalino ambra AM oppure bianco BI. Cavo di alimentazione trasparente. Rosone nero.</p>	<p>Suspension lamp. Diffuser in white BI or amber AM blown glass. Transparent power cable. Black ceiling rose.</p>	<p>Suspension. Diffuseur en verre soufflé opalin ambre AM ou blanc BI. Rosace noir. Câble de suspension transparent.</p>	<p>Hängeleuchte. Diffusor aus mundgeblasenem Opalglas bernsteinfarben AM oder weiß BI. Transparentes Netzkabel. Schwarzer Deckenbaldachin.</p>	<p>Lámpara de techo. Difusor de vidrio soplado opalino ámbar AM o blanco BI. Cable de alimentación transparente. Roseton negro.</p>
<p>lampadine / bulbs / ampoules / Glühbirnen / bombillas</p> <p>CE IP20 ENEC A+ INCL. LED NOT REPLACEABLE</p> <p>LED - 7W (3000 K, CRI 80, 550 Lm)</p>				

PASSION

pag. 230

Lampada da tavolo / Table lamp / Lampe de table / Tischleuchte / Lámpara de sobremesa

IT	EN	FR	DE	ES
 <p>3610/00... Lampada da tavolo con dimmer. Montatura in ottone cromato CR o nichelato spazzolato NC. Diffusore in vetro bianco opalino, soffiato e satinato. Riflettore superiore in metallo. Cavo di alimentazione, dimmer e spina trasparenti.</p>	<p>Table lamp with dimmer. Chromed CR or brushed nickel-plated NC brass frame. Diffuser in opaline frosted white blown glass. Metal upper reflector. Transparent power cable, dimmer and plug.</p>	<p>Lampe de table avec variateur. Structure en laiton chromé CR ou nickelé brossé NC. Diffuseur en verre blanc opalin, soufflé et satiné. Réflecteur supérieur en métal. Câble d'alimentation, variateur et fiche transparents.</p>	<p>Tischleuchte mit Dimmer. Gestell aus Messing verchromt CR oder vernickelt NC. Diffusor in weißem undgeblasenem und Oberer satiniertem Opalglas. Oberer Reflektor aus Metall. Netzkabel, Dimmer und Netzstecker transparent.</p>	<p>Lámpara de sobremesa con dimer. Montura de latón cromado CR o niquelado cepillado NC. Difusor de vidrio blanco opalino, soplado y satinado. Reflector superior de metal. Cable de alimentación, dimer y enchufe transparentes.</p>
<p>lampadine / bulbs / ampoules / Glühbirnen / bombillas</p> <p>CE IP20 Classe II ENEC ENEC D→E INCL. D</p> <p>1x60W (HA) G9 or 1x48W (HA) G9</p>				

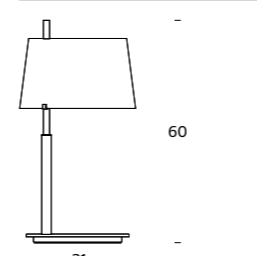
IT	EN	FR	DE	ES
 <p>3610/00... Lampada da tavolo con dimmer. Montatura in ottone cromato CR o nichelato spazzolato NC. Diffusore in vetro bianco opalino, soffiato e satinato. Riflettore superiore in metallo. Cavo di alimentazione, dimmer e spina trasparenti.</p>	<p>Table lamp with dimmer. Chromed CR or brushed nickel-plated NC brass frame. Diffuser in opaline frosted white blown glass. Metal upper reflector. Transparent power cable, dimmer and plug.</p>	<p>Lampe de table avec variateur. Structure en laiton chromé CR ou nickelé brossé NC. Diffuseur en verre blanc opalin, soufflé et satiné. Réflecteur supérieur en métal. Câble d'alimentation, variateur et fiche transparents.</p>	<p>Tischleuchte mit Dimmer. Gestell aus Messing verchromt CR oder vernickelt NC. Diffusor in weißem undgeblasenem und Oberer satiniertem Opalglas. Oberer Reflektor aus Metall. Netzkabel, Dimmer und Netzstecker transparent.</p>	<p>Lámpara de sobremesa con dimer. Montura de latón cromado CR o niquelado cepillado NC. Difusor de vidrio blanco opalino, soplado y satinado. Reflector superior de metal. Cable de alimentación, dimer y enchufe transparentes.</p>
<p>lampadine / bulbs / ampoules / Glühbirnen / bombillas</p> <p>CE IP20 Classe II ENEC ENEC A→E</p> <p>1x150W (HA) E27 or 1x20W (FL) E27</p>				

Lampada da terra / floor lamp / Lampadaire / Stehleuchte / Lámpara de pie

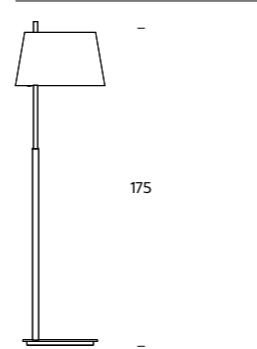
IT	EN	FR	DE	ES
 <p>3611... Lampada da terra con dimmer. Montatura in ottone cromato CR o nichelato spazzolato NC. Diffusore in vetro bianco soffiato e satinato. Riflettore superiore in metallo coordinato alla montatura. Cavo di alimentazione, dimmer e spina trasparenti.</p>	<p>Floor lamp with dimmer. Chrome-plated CR or brushed nickel-plated NC brass frame. Frosted white blown glass diffuser. Upper reflector in metal to match the frame. Transparent power cable, dimmer and plug.</p>	<p>Lampadaire avec variateur. Structure en laiton chromé CR ou nickelé brossé NC. Diffuseur en verre blanc, soufflé et satiné. Réflecteur supérieur en métal, coordonné à la structure. Câble d'alimentation, variateur et fiche transparents.</p>	<p>Stehlampe mit Dimmer. Gestell aus verchromtem CR oder vernickeltem und gebürstetem Messing NC. Diffusor aus weißem mundgeblasenem und satiniertem Glas. Oberer Metallreflektor mit dem Gestell koordiniert. Netzkabel, Dimmer und Netzstecker transparent.</p>	<p>Lámpara de pie con dimer. Montura de latón cromado CR o niquelado cepillado NC. Difusor de vidrio blanco, soplado y satinado. Reflector superior de metal a juego con la montura. Cable de alimentación, dimer y enchufe transparentes.</p>
<p>lampadine / bulbs / ampoules / Glühbirnen / bombillas</p> <p>CE IP20 Classe II ENEC ENEC A→E</p> <p>2x100W (HA) E27 or 2x20W (FL) E27</p>				

Lampada a sospensione / Suspension lamp / Suspension / Pendelleuchte / Suspensión

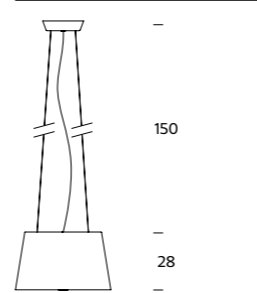
IT	EN	FR	DE	ES
 <p>3655 Lampada a sospensione. Diffusore e disco inferiore in vetro opalino soffiato bianco satinato. Rosone in metallo verniciato bianco con cavi di sospensione in acciaio e cavo di alimentazione trasparente.</p>	<p>Suspension lamp. Diffuser and lower disc in frosted white opaline blown glass. Metal canopy in white finish with steel suspension cables and transparent power cable.</p>	<p>Suspension. Diffuseur et disque inférieur en verre opalin soufflé blanc satiné. Rosace en métal peint en blanc, câbles de suspension en acier et câble d'alimentation transparent.</p>	<p>Hängeleuchte. Diffusor und untere Scheibe aus weißem, mundgeblasenem und satiniertem Opalglas. Rosette aus Metall, weiß lackiert, mit Aufhängekabeln aus Stahl und transparentem Netzkabel.</p>	<p>Lámpara de techo. Difusor y disco inferior de vidrio opalino soplado blanco satinado. Florón de metal pintado blanco con cables de suspensión de acero y cable de alimentación transparente.</p>
<p>lampadine / bulbs / ampoules / Glühbirnen / bombillas</p> <p>CE IP20 ENEC ENEC D→E</p> <p>1x150W (HA) E27</p>				

PINECONE

pag. 236

Lampada da tavolo / Table lamp / Lampe de table / Tischleuchte / Lámpara de sobremesa

IT	EN	FR	DE	ES
<p>4340..</p> <p>Lampada da tavolo. Diffusore in vetro soffiato trasparente TR oppure bianco latte acidato BI. Gabbia in metallo nichelato. Base di metallo bianco (RAL 9002). Cavo di alimentazione, dimmer e spina trasparenti.</p>	<p>Table lamp. Diffuser in transparent TR or milky acid-etched BI blown glass. Nickel-plated metal cage. White metal base (RAL 9002). Transparent dimmer, plug and power cord.</p>	<p>Lampe de table. Diffuseur en verre soufflé transparent TR ou blanc laiteux acidé BI. Cage en métal nickelé. Socle en métal blanc (RAL 9002). Câble d'alimentation, variateur et fiche transparents.</p>	<p>Tischleuchte. Diffusor aus geblasenem Glas transparent TR oder milchweiß geätzt BI. Metallkorb vernickelt. Basis aus weiß lackiertem Metall (RAL 9002). Fassung E27 max.150W, Zuleitung, Dimmer und Stecker transparent.</p>	<p>Lámpara de mesa. Difusor de vidrio soplado transparente TR o blanco opalino BI. Jaula de metal niquelado. Base de metal blanco (RAL 9002). Cable de alimentación, dimmer y clavija transparentes.</p>

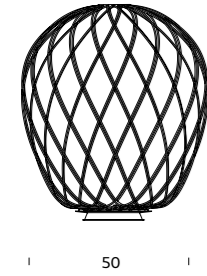

lampadine / bulbs / ampoules / Glühbirnen / bombillas

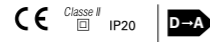

1x150W (HA) E27

Lampada a sospensione / Suspension lamp / Suspension / Pendelleuchte / Suspensión

IT	EN	FR	DE	ES
<p>4340..</p> <p>Lampada a sospensione. Diffusore in vetro soffiato trasparente TR oppure bianco latte acidato BI. Gabbia in metallo nichelato. Cavo di alimentazione trasparente. Cavi di sospensione in acciaio. Rosone bianco (RAL 9002).</p>	<p>Pendant lamp. Diffuser in transparent TR or milky acid-etched BI blown glass. Nickel-plated metal cage. Transparent power cord. Steel suspension cable. (RAL 9002) white ceiling rose.</p>	<p>Suspension. Diffuseur en verre soufflé transparent TR ou blanc laiteux acidé BI. Cage en métal nickelé. Câble d'alimentation transparent. Filis de suspension en acier. Rosace blanc (RAL 9002).</p>	<p>Pendelleuchte. Diffusor aus geblasenem Glas transparent TR oder milchweiß geätzt BI. Metallkorb vernickelt. Fassung E27 max.150W. Zuleitung transparent. Abhängung aus Stahlseil. Deckenkappe weiß (RAL 9002).</p>	<p>Lámpara de suspensión. Difusor de vidrio soplado transparente TR o blanco opalino BI. Jaula de metal niquelado. Cable de alimentación transparente. Cables de suspensión de acero. Rosetón blanco (RAL 9002).</p>

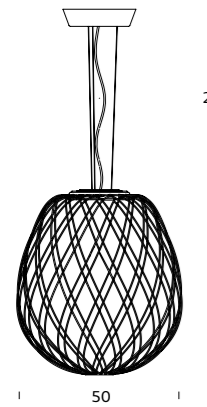

lampadine / bulbs / ampoules / Glühbirnen / bombillas

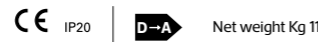

1x150W (HA) E27

PIRELLINA

pag. 240

Lampada da tavolo / Table lamp / Lampe de table / Tischleuchte / Lámpara de sobremesa

IT	EN	FR	DE	ES
<p>2781</p> <p>Lampada da tavolo con dimmer. Montatura in fusione di ottone nichelato. Diffusori in vetro stampato e curvato. Cavo di alimentazione, dimmer e spina trasparenti.</p>	<p>Table lamp with dimmer. Nickel-plated cast brass frame. Diffusers in curved pressed glass. Transparent power cable, dimmer and plug.</p>	<p>Lampe de table avec variateur. Structure en laiton nickelé moulé. Diffuseur en verre moulé et courbé. Câble d'alimentation, variateur et fiche transparents.</p>	<p>Tischleuchte mit Dimmer. Gestell aus vernickeltem Messingguss. Diffusoren aus gebogenem Pressglas. Netzkabel, Dimmer und Netzstecker transparent.</p>	<p>Lámpara de sobremesa con dimer. Montura de latón niquelado colado. Difusores de vidrio grabado y curvado. Cable de alimentación, dimer y enchufe transparentes.</p>

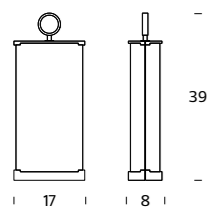

lampadine / bulbs / ampoules / Glühbirnen / bombillas



4x25W (IN) E14 or 4x18W (HA) E14

PIRELLONE

pag. 240

Lampada da terra / floor lamp / Lampadaire / Stehleuchte / Lámpara de pie

IT	EN	FR	DE	ES
<p>2758</p> <p>Lampada da terra con dimmer e doppia emissione di luce, diffusa e indiretta. Montatura in ottone nichelato satinato. Diffusori in vetro stampato e curvato. Cavo di alimentazione, dimmer e spina neri.</p>	<p>Floor lamp with dimmer and dual emission for soft and indirect beam. Frame in satined nickel-plated brass. Diffusers in pressed curved glass. Black power cable, dimmer and plug.</p>	<p>Lampadaire avec variateur et double émission de lumière, diffuse et indirecte. Structure en laiton nickelé satiné. Diffuseurs en verre moulé et courbé. Câble d'alimentation, variateur et fiche noirs.</p>	<p>Stehleuchte mit Dimmer und doppelter Lichtausstrahlung. Gestell aus satiniertem, vernickeltem Messing. Diffusoren aus gebogenem Pressglas. Netzkabel, Dimmer und Netzstecker schwarz.</p>	<p>Lámpara de pie con dimer y doble emisión de luz, difusa e indirecta. Montura de latón niquelado satinado. Difusores de vidrio grabado y curvado. Cable de alimentación, dimer y enchufe negros.</p>

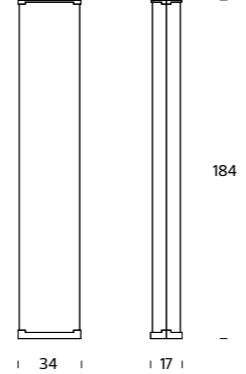

lampadine / bulbs / ampoules / Glühbirnen / bombillas



10x40W (HA) G9 or 10x33W (HA) G9 + 1x230W (HA) R7s/115

POLARIS

pag. 244

Lampada da terra / Floor lamp / Lampadaire / Stehleuchte / Lámpara de pie

IT	EN	FR	DE	ES
<p>3829...</p> <p>Lampada da terra con dimmer. Corpo in nylon stampato con tecnologia rotazionale e verniciato. Base in acciaio satinato. Scocca lucida bianca BI (RAL 9003 lucido) o nera N (RAL 9005 lucido). Cavo di alimentazione, dimmer e spina trasparenti.</p>	<p>Floor lamp with dimmer. Rotation-moulded, lacquered nylon body. Frosted steel base. Gloss white BI (RAL 9003 gloss) or black N (RAL 9005 gloss). Transparent power cable, dimmer and plug.</p>	<p>Lampadaire avec variateur. Corps en nylon peint moulé avec la technologie rotationnelle. Base en acier satiné. Coque brillante blanche BI (RAL 9003 brillante) ou noire N (RAL 9005 brillante). Câble d'alimentation, variateur et fiche transparents.</p>	<p>Stehleuchte mit Dimmer. Körper aus lackiertem und durch Rotationspressung hergestelltem Nylon. Basis aus satiniertem Stahl. Körper glänzend weiß BI (RAL 9003 glänzend) oder schwarz N (RAL 9005 glänzend). Netzkabel, Dimmer und Netzstecker transparent.</p>	<p>Lámpara de pie con dimer. Cuerpo de nailon grabado con tecnología rotacional y pintado. Base de acero satinado. Armazón brillante blanco BI (RAL 9003 brillante) o negro N (RAL 9005 brillante). Cable de alimentación, dimer y enchufe transparentes.</p>

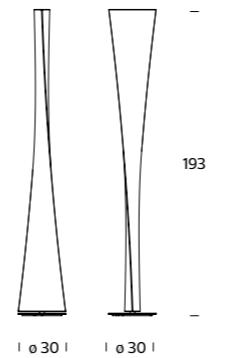

lampadine / bulbs / ampoules / Glühbirnen / bombillas



1x230W (HA) R7s/115

PRIMA SIGNORA

pag. 246

Lampada da terra / Floor lamp / Lampadaire / Stehleuchte / Lámpara de pie

IT	EN	FR	DE	ES
<p>M2891CR+ V2891BI</p> <p>Lampada da terra con dimmer. Struttura in metallo cromato. Diffusore in vetro soffiato opalino bianco. Cavo di alimentazione, dimmer e spina trasparenti.</p> <p>M2891CR struttura V2891BI diffusore</p>	<p>Floor lamp with dimmer. Chromed metal frame. Opaline white blown glass diffuser. Transparent power cable, dimmer and plug.</p> <p>M2891CR frame V2891BI diffuser</p>	<p>Lampadaire avec variateur. Structure en métal chromé. Diffuseur en verre soufflé opalin blanc. Câble d'alimentation, variateur et fiche transparents.</p> <p>M2891CR structure V2891BI diffuseur</p>	<p>Stehleuchte mit Dimmer. Struktur aus verchromtem Metall. Diffusor aus weißem mundgeblasenem Opalglas. Netzkabel, Dimmer und Netzstecker transparent.</p> <p>M2891CR Struktur V2891BI Diffusor</p>	<p>Lámpara de pie con dimer. Estructura de metal cromado. Difusor de vidrio soplado opalino blanco. Cable de alimentación, dimer y enchufe transparentes.</p> <p>M2891CR estructura V2891BI difusor</p>

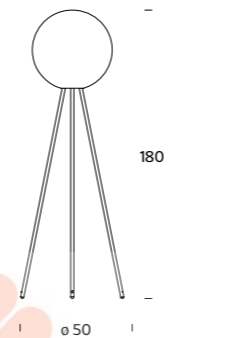

lampadine / bulbs / ampoules / Glühbirnen / bombillas



1x205W (HA) E27

PUDDING

pag. 248

Lampada a sospensione / Suspension lamp / Suspension / Pendelleuchte / Suspensión

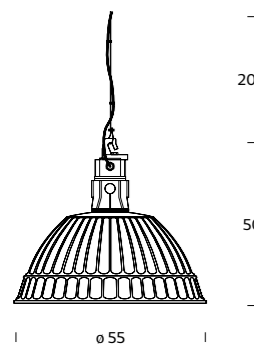

M5217+
P5217

Lampada a sospensione. Riflettore in alluminio sfaccettato e anodizzato. Montatura e gancio a bilanciata in fusione di alluminio. La lampada può essere provvista di un disco in vetro temperato trasparente con anello di chiusura.
M5217 montatura
P5217 riflettore
V5217 disco in vetro opzionale

Suspension lamp. Reflector in faceted anodized aluminium. Cast aluminium frame and balance hook. The lamp fits an optional transparent tempered glass disc with cover.
M5217 frame
P5217 reflector
V5217 optional glass disc

Suspension. Réflecteur en aluminium à facettes et anodisé. Structure et crochet à balancier en aluminium coulé. La lampe peut être équipée d'un disque en verre trempé transparent avec anneau de fermeture.
M5217 structure
P5217 réflecteur
V5217 disque en verre optionnel

Hängeleuchte. Reflektor aus facettiertem und eloxiertem Aluminium. Gestell und Kipphebel aus Aluminiumguss. Die Leuchte kann mit einer Scheibe aus transparentem getempertem Glas mit Abschlussring geliefert werden.
M5217 Gestell
P5217 Reflektor
V5217 optionale Glasscheibe

Lámpara de techo. Reflector de aluminio tallado y anodizado. Montura y gancho de balancin de aluminio colado. Se puede equipar la lámpara con un disco de vidrio templado transparente con anilla de cierre.
M5217 montura
P5217 reflector
V5217 disco de vidrio opcional

lampadine / bulbs / ampoules / Glühbirnen / bombillas



1x205W (HA) E27 or
1x30W (FL) E27

RIGA

pag. 250 (outdoor pag. 336)

Lampada da parete / Wall lamp / Applique / Wandleuchte / Applique

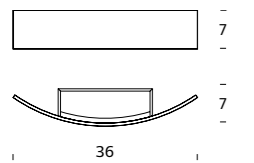

5214...

lampadine / bulbs / ampoules / Glühbirnen / bombillas



1x80W (HA) R7s/80

4281..

lampadine / bulbs / ampoules / Glühbirnen / bombillas



2x9W LED (2700 K, CRI>80, 850 Lm+850 Lm)

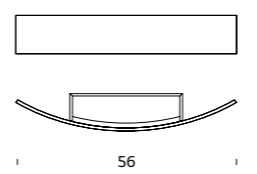

5398...

lampadine / bulbs / ampoules / Glühbirnen / bombillas



1x120W (HA) R7s/115

5404...

lampadine / bulbs / ampoules / Glühbirnen / bombillas



1x26W (FL) G24d-3

4282..

lampadine / bulbs / ampoules / Glühbirnen / bombillas



2x9W LED (2700 K, CRI>80, 850 Lm+850 Lm)

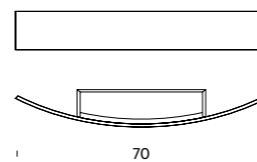

5214/1..

lampadine / bulbs / ampoules / Glühbirnen / bombillas



2x80W (HA) R7s/80

5244...

lampadine / bulbs / ampoules / Glühbirnen / bombillas

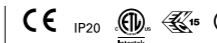

2x15W (FL) E27

4283..

lampadine / bulbs / ampoules / Glühbirnen / bombillas



2x9W LED (2700 K, CRI>80, 910 Lm+910 lm)

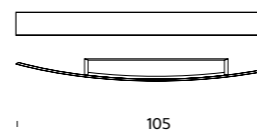

5392/1...

lampadine / bulbs / ampoules / Glühbirnen / bombillas



1x24W (FL) G5

5406/1..



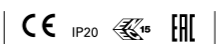





lampadine / bulbs / ampoules / Glühbirnen / bombillas

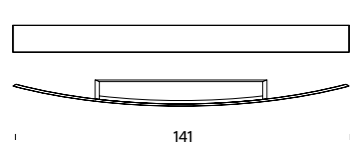

2x80W (HA) R7s/80

RILUMINATOR

pag. 254

IT	EN	FR	DE	ES	
	<p>Lampada da parete. Montatura in acciaio inox lucido AXL, metallo nichelato spazzolato NS, trattato con vernice antiriflesso e antigraffio color bianco BI (RAL 9010 opaco). Diffusori in vetro temperato sabbiato.</p>	<p>Wall lamp. Frame in polished stainless steel AXL, brushed nickel-plated metal NS, with antiglare, scratchproof finish in white BI (RAL 9010 matt). Tempered sandblasted glass diffusers.</p>	<p>Applique. Structure en acier inox brillant AXL, métal nickelé brossé NS, traité avec peinture antireflet et inrayable couleur blanc BI (RAL 9010 mate). Diffuseurs en verre trempé sablé.</p>	<p>Wandleuchte. Gestell aus poliertem Edelstahl AXL, vernickeltem gebürstetem Metall NS, mit blendfreier und kratzfester Lackierung weiß BI (RAL 9010 matt). Diffusoren aus sandgestrahltem getempertem Glas.</p>	<p>Lámpara de pared. Montura de acero inoxidable brillante AXL, metal niquelado cepillado NS, tratado con pintura antirreflejo y antirrayado de color blanco BI (RAL 9010 mate). Difusores de vidrio templado arenado.</p>
5214/2...	<p>lampadine / bulbs / ampoules / Glühbirnen / bombillas</p> <p>3×120W (HA)  R7s/T15</p>	<p> IP20  </p>			
5244/2...	<p>lampadine / bulbs / ampoules / Glühbirnen / bombillas</p> <p>2×39W (FL) G5</p>	<p> IP20  </p>			

Esterno / Outdoor / Extérieur / Außen / Exterior

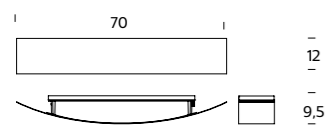

IT	EN	FR	DE	ES
<p>Lampada da parete da esterno. Doppia emissione luminosa, diretta e indiretta. Attacco a parete in alluminio. Corpo in policarbonato satinato opalino provvisto di due guide, posizionate nella parte superiore e inferiore dell'apparecchio che consentono l'inserimento di una maschera opzionale per bloccare il flusso luminoso diretto oppure indiretto. Schermi frontali in acciaio inox nichelato spazzolato NS o in ferro protetto agli agenti atmosferici verniciato color alluminio anodizzato AA. L'apparecchio può essere installato in posizione orizzontale oppure verticale.</p> <p>Alimentatore elettronico incluso.</p> <p>M3930 Corpo 70x12x9,5</p> <p>+ S3930.. Schermo frontale</p>	<p>Outdoor wall lamp. Dual light emission, direct and indirect. Aluminium wall mount. Opaline frosted polycarbonate body with upper and lower guide for application of an optional front to secure direct or indirect beam. Front shields available in brushed nickel-plated stainless steel NS or in iron protected against atmospheric agents by anodized aluminium colour finish AA. The fixture may be installed horizontally or vertically.</p> <p>Electronic ballast included.</p> <p>M3930 Body 70x12x9,5</p> <p>+ S3930.. Front shield</p>	<p>Applique d'extérieur. Double émission lumineuse, directe et indirecte. Fixation murale en aluminium. Corps en polycarbonate satiné opalin pourvu de deux glissières, situées en haut et en bas de l'appareil, permettant d'insérer un écran optionnel pour bloquer le flux lumineux direct ou indirect. Écrans frontaux en acier inox, nickelé et brossé NS ou en fer, protégé contre les agents atmosphériques, peint en couleur aluminium anodisé AA. L'appareil peut être installé en position horizontale ou verticale.</p> <p>Alimentateur électronique inclus.</p> <p>M3930 Corps 70x12x9,5</p> <p>+ S3930.. Écran frontal</p>	<p>Wandleuchte für den Außenbereich. Doppelte direkte und indirekte Lichtausstrahlung. Wand-befestigung aus Aluminium. Der Leuchtenkörper aus satiniertem Polycarbonat opal ist im oberen und unteren Teil der Leuchte mit zwei Führungen versehen. Diese dienen zur Einführung einer optionalen Maske, die den direkten oder indirekten Lichtstrom blockieren kann. Frontschirme aus gebürstetem vernickeltem Edelstahl NS oder aus lackiertem Eisen mit Schutzbehandlung gegen Witterungseinflüsse aus eloxiertem Aluminium AA. Die Leuchte kann horizontal oder vertikal installiert werden.</p> <p>Elektronisches Vorschaltgerät inbegriffen.</p> <p>M3930 Körper 70x12x9,5</p> <p>+ S3930.. Frontschirm</p>	<p>Lámpara de pared para exteriores. Doble emisión luminosa, directa e indirecta. Soporte mural de aluminio. Cuerpo de policarbonato satinado opalino equipado con dos guías, colocadas en la parte superior e inferior del aparato, que permiten introducir una máscara opcional para bloquear el flujo luminoso directo o indirecto. Pantallas frontales de acero inoxidable niquelado cepillado o de hierro protegido contra los agentes atmosféricos NS y pintado en color aluminio anodizado AA. El equipo se puede instalar en posición horizontal o vertical.</p> <p>Alimentador electrónico incluido.</p> <p>M3930 Cuerpo 70x12x9,5</p> <p>+ S3930.. Pantalla frontal</p>
<p>lampadine / bulbs / ampoules / Glühbirnen / bombillas</p> <p>1×26W (FL) GX24q-3 1×32W (FL) GX24q-3 1×42W (FL) GX24q-4</p>	<p> IP65  </p>			

Accessori / Accessories / Accessoires / Zubehör / Accesorios

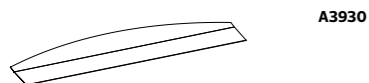

A3930	Maschera opzionale	Optional mask	Écran optionnel	Optionale Maske	Máscara opcional
--------------	--------------------	---------------	-----------------	-----------------	------------------

Lampada da terra / Floor lamp / Lampadaire / Stehleuchte / Lámpara de pie

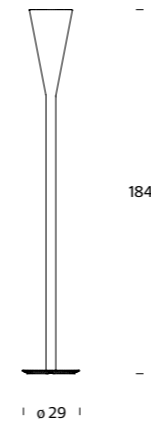





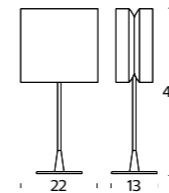

IT	EN	FR	DE	ES
<p>4259...</p> <p>Lampada da terra. Corpo in tecnopolimero plastico prodotto con tecnologia "rotazionale". Base in acciaio. Cavo di alimentazione, spina e interruttore on/off trasparente. Disponibile bianco BI (RAL 1013), rosso R (RAL 3013) e grigio scuro GS (RAL 7022).</p>	<p>Floor lamp. Body in plastic technopolymer produced using "rotation" technology. Base in steel. Clear power cable, plug and on/off switch. Available in white BI (RAL 1013), red R (RAL 3013) and dark grey GS (RAL 7022). The light source can be regulated with a specific LED dimmer.</p>	<p>Lampadaire. Corps en technopolymère plastique produit par rotomoulage. Base en acier. Câble d'alimentation, fiche et interrupteur marche/arrêt transparent. Disponible en blanc BI (RAL 1013), rouge R (RAL 3013) et gris foncé GS (RAL 7022). La source lumineuse est réglable grâce à l'utilisation de variateurs de lumière pour sources à LED.</p>	<p>Bodenleuchte. Körper aus mit Rotationstechnologie hergestelltem Technopolymer. Stahlbasis. Stromkabel, Stecker und On/Off-Schalter transparent. Erhältlich weiß BI (RAL 1013), rot R (RAL 3013) und dunkelgrau GS (RAL 7022). Die Lichtquelle kann durch spezielle LED-Lichtquellen reguliert werden.</p>	<p>Lámpara de pie. Cuerpo de tecnopolímero plástico producido con tecnología «rotacional». Base de acero. Cable de alimentación, enchufe e interruptor on/off transparente. Disponible en blanco BI (RAL 1013), rojo R (RAL 3013) y gris oscuro GS (RAL 7022). La fuente luminosa puede regularse utilizando dimer luminosos específicos para fuentes LED.</p>
<p>lampadine / bulbs / ampoules / Glühbirnen / bombillas</p> <p>1 LED - 19,5W (3000K, CRI 85, 2000 Lm)</p>	<p> IP20   </p>			

SARA

pag. 256





Lampada da tavolo / Table lamp / Lampe de table / Tischleuchte / Lámpara de sobremesa

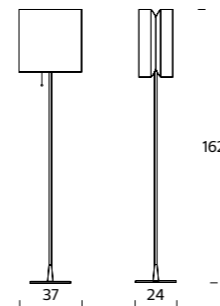

IT	EN	FR	DE	ES
<p>5139...</p> <p>Lampada da tavolo. Montatura in metallo verniciato color alluminio A/BI o cromo CR/BI. Diffusore in policarbonato serigrafato bianco. Cavo di alimentazione, interruttore e spina neri.</p>	<p>Table lamp. Frame in aluminium A/BI or chrome CR/BI finish. Diffuser in white screen-printed polycarbonate. Black power cable, plug and switch.</p>	<p>Lampe de table. Structure en métal peint en couleur aluminium A/BI ou chromé CR/BI. Diffuseur en polycarbonate sérigraphié blanc. Câble d'alimentation, fiche et interrupteur noirs.</p>	<p>Tischleuchte. Gestell aus lackiertem Metall, Farbe aluminium A/BI oder chrom CR/BI. Diffusor aus weißem siebbedrucktem Polycarbonat. Netzkabel, Netzstecker und Schalter schwarz.</p>	<p>Lámpara de sobremesa. Montura de metal pintado color aluminio A/BI o cromado CR/BI. Difusor de policarbonato serigrafado blanco. Cable de alimentación, enchufe e interruptor negros.</p>
<p>lampadine / bulbs / ampoules / Glühbirnen / bombillas</p> <p>1×60W (IN) E14 or 1×42W (HA)  E14</p>	<p> IP20   </p>			

Lampada da terra / Floor lamp / Lampadaire / Stehleuchte / Lámpara de pie



IT	EN	FR	DE	ES
<p>5154...</p> <p>Lampada da terra. Montatura in metallo verniciato color alluminio A/BI oppure cromato CR/BI. Diffusore in policarbonato serigrafato bianco. Accensione con cordicella. Cavo di alimentazione e spina neri.</p>	<p>Floor lamp. Metal frame in aluminium A/BI colour or chromed CR/BI finish. Diffuser in screen-printed white polycarbonate. On/off cord. Black power cable and plug.</p>	<p>Lampadaire. Structure en métal peint en couleur aluminium A/BI ou chromé CR/BI. Diffuseur en polycarbonate sérigraphié blanc. Allumage grâce à une cordelette. Câble d'alimentation et fiche noirs.</p>	<p>Stehleuchte. Gestell aus Metall, aluminiumfarben A/BI oder verchromt CR/BI. Diffusor aus weißem siebbedrucktem Polycarbonat. Einschaltung durch Kordel. Netzkabel und Netzstecker schwarz.</p>	<p>Lámpara de pie. Montura de metal pintado color aluminio A/BI o cromado CR/BI. Difusor de policarbonato serigrafado blanco. Encendido con cuerda. Cable de alimentación y enchufe negros.</p>
<p>lampadine / bulbs / ampoules / Glühbirnen / bombillas</p> <p>1×140W (HA)  E27</p>	<p> IP20   </p>			

Lampada da parete / Wall lamp / Applique
Wandleuchte / Applique

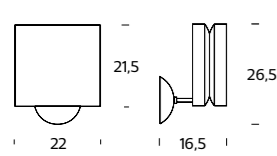

5155...

IT	EN	FR	DE	ES
Lampada da parete. Montatura in metallo verniciato color alluminio A/BI oppure cromato CR/BI . Diffusore in policarbonato serigrafato bianco.	Wall lamp. Aluminium-painted A/BI or chromed CR/BI metal frame. Screen-printed white polycarbonate diffuser.	Applique. Structure en métal peint en couleur aluminium A/BI ou chromé CR/BI . Diffuseur en polycarbonate sérigraphié blanc.	Wandleuchte. Gestell aus Metall aluminiumfarben lackiert A/BI oder verchromt CR/BI . Diffusor aus siebgedrucktem weißem Polycarbonat.	Lámpara de pared. Montura de metal pintado color aluminio A/BI o cromado CR/BI . Difusor de policarbonato serigrafado blanco.

lampadine / bulbs / ampoules / Glühbirnen / bombillas

CE IP20 Classe II

1x42W (HA) E14

Lampada da terra / Floor lamp / Lampadaire
Stehleuchte / Lámpara de pie

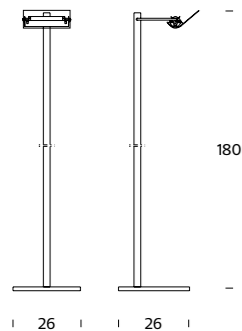

2729...

IT	EN	FR	DE	ES
Lampada da terra con dimmer. Struttura in metallo cromato CR o nichelato satinato NS . Portalampana in acciaio cromato. Riflettore in alluminio anodizzato. Cavo di alimentazione tigrato, dimmer e spina neri.	Floor lamp with dimmer. Frame in chromed CR or satin nickel-plated NS metal. Chromed steel lamp holder. Anodized aluminium reflector. Braided black and white fabric cable, black dimmer and plug.	Lampadaire avec variateur. Structure en métal chromé CR ou nickelé satiné NS . Douille en acier chromée. Réflecteur en aluminium anodisé. Câble d'alimentation noir et blanc, variateur et fiche noirs.	Stehleuchte mit Dimmer. Metallstruktur, verchromt CR oder satiniert vernickelt NS . Lampenfassung aus Chromstahl. Reflektor aus eloxiertem Aluminium. Netzkabel mit schwarz/weißer Textilummantelung, Dimmer und Netzstecker schwarz.	Lámpara de pie con dimmer. Estructura de metal cromado CR o niquelado satinado NS . Portabombilla de acero cromado. Reflector de aluminio anodizado. Cable revestido en tejido blanco y negro, dimmer y enchufe negros.

lampadine / bulbs / ampoules / Glühbirnen / bombillas

CE IP20

1x230W (HA) R7s/115

Lampada da parete / Wall lamp / Applique
Wandleuchte / Applique

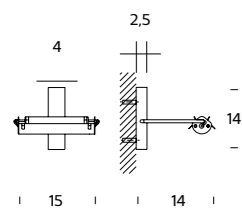

ATIP150...

IT	EN	FR	DE	ES
Lampada da parete. Struttura e attacco a parete in acciaio cromato CR , nichelato satinato NS oppure verniciato bianco BI . Schermi di sicurezza in vetro borosilicato trasparente e sabbiato.	Wall lamp. Chromed CR , satin nickel-plated NS or white-painted BI steel frame and wall bracket. Sandblasted transparent borosilicate glass shields.	Applique. Structure et fixation murale en acier chromé CR , nickelé satiné NS ou blanc BI . Écrans de sécurité en verre borosilicate transparent et sablé.	Wandleuchte. Struktur und Wandbefestigung aus Stahl verchromt CR , vernickelt satiniert NS oder weiß lackiert BI . Sicherheitsblenden aus transparentem und sandgestrahltem Borosilikatglas.	Lámpara de pared. Estructura y soporte mural de acero cromado CR , niquelado satinado NS o pintado blanco BI . Pantallas de seguridad de vidrio borosilicato transparente y arenado.

lampadine / bulbs / ampoules / Glühbirnen / bombillas

CE IP20

1x120W (HA) R7s/80

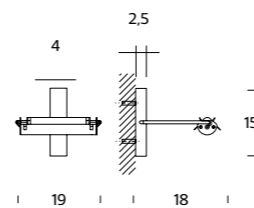

ATIP300...

IT	EN	FR	DE	ES
Lampada da parete. Struttura e attacco a parete in acciaio cromato CR , nichelato satinato NS oppure verniciato bianco BI . Schermi di sicurezza in vetro borosilicato trasparente e sabbiato.	Wall lamp. Chromed CR , satin nickel-plated NS or white-painted BI steel frame and wall bracket. Sandblasted transparent borosilicate glass shields.	Applique. Structure et fixation murale en acier chromé CR , nickelé satiné NS ou blanc BI . Écrans de sécurité en verre borosilicate transparent et sablé.	Wandleuchte. Struktur und Wandbefestigung aus Stahl verchromt CR , vernickelt satiniert NS oder weiß lackiert BI . Sicherheitsblenden aus transparentem und sandgestrahltem Borosilikatglas.	Lámpara de pared. Estructura y soporte mural de acero cromado CR , niquelado satinado NS o pintado blanco BI . Pantallas de seguridad de vidrio borosilicato transparente y arenado.

lampadine / bulbs / ampoules / Glühbirnen / bombillas

CE IP20

1x230W (HA) R7s/115

lampadine / bulbs / ampoules / Glühbirnen / bombillas

CE IP20

1x230W (HA) R7s/115

Lampada a sospensione / Suspension lamp
Suspension / Pendelleuchte / Suspensión

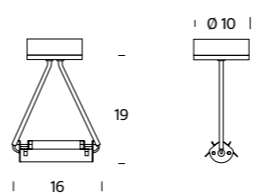

ATIS150...

IT	EN	FR	DE	ES
Lampada a sospensione. Struttura cromata CR , nichelata satinata NS oppure bianca BI . La lampada è provvista di schermi di sicurezza in vetro borosilicato trasparente e sabbiato e un distanziatore per connessioni elettriche. Un riflettore per luce indiretta è disponibile come accessorio.	Suspension lamp. Chromed CR , satin nickel-plated NS or white BI finish frame. The lamp features transparent sandblasted borosilicate glass shields and a spacer for electrical connections. Optional reflector for indirect beam.	Suspension. Structure chromée CR , nickelée satinée NS ou blanche BI . La lampe est équipée d'écrans de sécurité en verre borosilicate, transparent et sablé, et d'une entretoise pour les connexions électriques. Un réflecteur pour la lumière indirecte est disponible en accessoire.	Hängeleuchte. Struktur verchromt CR , vernickelt satiniert NS oder weiße BI . Die Leuchte ist mit Sicherheitsblenden aus transparentem und gesandstrahltem Borosilikatglas und mit Distanzstück für die Stromversorgung ausgestattet. Ein Reflektor für indirektes Licht ist als Zubehör erhältlich.	Lámpara de techo. Estructura cromada CR , niquelada satinada NS o blanca BI . La lámpara está provista de pantallas de seguridad de vidrio borosilicato transparente y arenado y de un distanciador para conexiones eléctricas. Reflector para luz indirecta opcional.

lampadine / bulbs / ampoules / Glühbirnen / bombillas

CE IP20

1x120W (HA) R7s/80

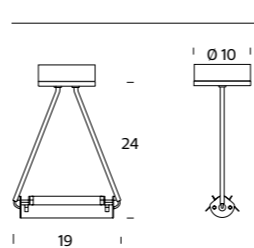

ATIS300...

IT	EN	FR	DE	ES
Lampada a sospensione. Struttura cromata CR , nichelata satinata NS oppure bianca BI . La lampada è provvista di schermi di sicurezza in vetro borosilicato trasparente e sabbiato e un distanziatore per connessioni elettriche. Un riflettore per luce indiretta è disponibile come accessorio.	Suspension lamp. Chromed CR , satin nickel-plated NS or white BI finish frame. The lamp features transparent sandblasted borosilicate glass shields and a spacer for electrical connections. Optional reflector for indirect beam.	Suspension. Structure chromée CR , nickelée satinée NS ou blanche BI . La lampe est équipée d'écrans de sécurité en verre borosilicate, transparent et sablé, et d'une entretoise pour les connexions électriques. Un réflecteur pour la lumière indirecte est disponible en accessoire.	Hängeleuchte. Struktur verchromt CR , vernickelt satiniert NS oder weiße BI . Die Leuchte ist mit Sicherheitsblenden aus transparentem und gesandstrahltem Borosilikatglas und mit Distanzstück für die Stromversorgung ausgestattet. Ein Reflektor für indirektes Licht ist als Zubehör erhältlich.	Lámpara de techo. Estructura cromada CR , niquelada satinada NS o blanca BI . La lámpara está provista de pantallas de seguridad de vidrio borosilicato transparente y arenado y de un distanciador para conexiones eléctricas. Reflector para luz indirecta opcional.

lampadine / bulbs / ampoules / Glühbirnen / bombillas

CE IP20

1x230W (HA) R7s/115

SERPENTINE

pag. 264

Lampada a sospensione / Suspension lamp
Suspension / Pendelleuchte / Suspensión

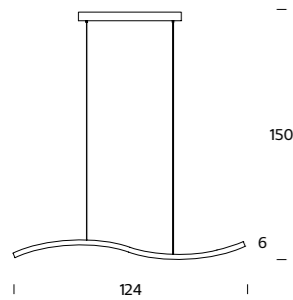

150
6
124

4175BI

IT Lampada a sospensione. Struttura in alluminio estruso e curvato, verniciato bianco. Cavi di alimentazione/ sospensione trasparenti con sistema di regolazione lunghezza cavi all'interno della canalina e sistema di bilanciamento sul corpo tramite asola. Schermo in metacrilato millerighe. Emissione di luce diretta.

EN Suspension lamp. Curved extruded aluminium frame with white finish. Transparent length-adjustable power/ suspension cables housed in raceway; keyhole body balancing system. Methacrylate pinwale shield. Direct beam.

FR Suspension. Structure en aluminium extrudé et courbé, peint en blanc. Câbles d'alimentation/ suspension transparents avec système de réglage longueur câbles à l'intérieur de la goulotte. Écran en méthacrylate mille raies. Émission de lumière directe.

DE Hängeleuchte. Struktur aus gebogenem Aluminiumprofil, weiß lackiert. Transparente Strom- und Aufhängekabel mit Verstellsystem der Kabelkanals und Ausgleichssystem am Lampenkörper über eine Öse. Lampenschirm aus gerilltem Methacrylat. Direkte Lichtausstrahlung.

ES Lámpara de techo. Estructura de aluminio extruido y curvado, pintado blanco. Cables de alimentación/suspensión transparentes con sistema de regulación de la longitud de los cables en el interior del canal de cables y sistema de equilibrado en el cuerpo mediante una ranura. Pantalla de metacrilato milrayas. Emisión de luz directa.

lampadine / bulbs / ampoules / Glühbirnen / bombillas



○ 364 LED - 23W (3500 K, CRI 80, 2090 Lm)

Lampada da parete e plafone / Wall and ceiling lamp / Applique ou plafonnier / Wand-order und Deckenleuchte / Aplique y plafón

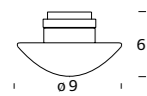

6
ø9

2775/2G

IT Lampada da parete/plafone a bassa tensione. Montatura in tecnopolimero a elevata resistenza termica. Diffusore in vetro sabbiato termoresistente.

EN Low voltage wall and ceiling lamp. High heat-resistant technopolymer frame. Heat-resistant sandblasted glass diffuser.

FR Applique/plafonnier à basse tension. Structure en technopolymère à résistance thermique élevée. Diffuseur en verre sablé thermorésistant.

DE Niederspannung- Wand- und Deckenleuchte. Gestell aus hoch hitzebeständigem Technopolymer. Diffusor aus hitzebeständigem sandgestrahltem Glas.

ES Lámpara de pared/plafón de baja tensión. Montura de tecnopolímero de elevada resistencia térmica. Difusor de vidrio arenado resistente al calor.

lampadine / bulbs / ampoules / Glühbirnen / bombillas



☞ 1×20W (HA) G4 12V or
☞ 1×14W (HA) (ES) G4 12V

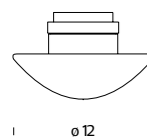

7
ø12

2775/5G

IT Lampada da parete/plafone a bassa tensione. Montatura in tecnopolimero a elevata resistenza termica. Diffusore in vetro sabbiato termoresistente.

EN Low voltage wall and ceiling lamp. High heat-resistant technopolymer frame. Heat-resistant sandblasted glass diffuser.

FR Applique/plafonnier à basse tension. Structure en technopolymère à résistance thermique élevée. Diffuseur en verre sablé thermorésistant.

DE Niederspannung- Wand- und Deckenleuchte. Gestell aus hoch hitzebeständigem Technopolymer. Diffusor aus hitzebeständigem sandgestrahltem Glas.

ES Lámpara de pared/plafón de baja tensión. Montura de tecnopolímero de elevada resistencia térmica. Difusor de vidrio arenado resistente al calor.

lampadine / bulbs / ampoules / Glühbirnen / bombillas



☞ 1×50W (HA)GY6.35 12V or
☞ 1×35W (HA) (ES) GY6.35 12V

IT EN FR DE ES

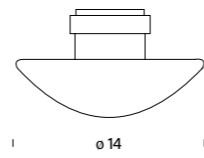

9
ø14

2775/7/23G

IT Lampada da parete/plafone. Montatura in tecnopolimero a elevata resistenza termica. Diffusore in vetro sabbiato termoresistente.

EN Wall/ceiling lamp. High heat-resistant technopolymer frame. Heat-resistant sandblasted glass diffuser.

FR Applique/plafonnier. Structure en technopolymère à résistance thermique élevée. Diffuseur en verre sablé thermorésistant.

DE Wand-/Deckenleuchte. Gestell aus hoch hitzebeständigem Technopolymer. Diffusor aus hitzebeständigem sandgestrahltem Glas.

ES Lámpara de pared/plafón. Montura de tecnopolímero de elevada resistencia térmica. Difusor de vidrio arenado resistente al calor.

lampadine / bulbs / ampoules / Glühbirnen / bombillas



☞ 1×60W max (HA) (ES) G9

4221/7/23G

IT Lampada da parete/plafone. Montatura in tecnopolimero a elevata resistenza termica. Diffusore in vetro sabbiato termoresistente.

EN Wall/ceiling lamp. High heat-resistant technopolymer frame. Heat-resistant sandblasted glass diffuser.

FR Applique/plafonnier. Structure en technopolymère à résistance thermique élevée. Diffuseur en verre sablé thermorésistant.

DE Wand-/Deckenleuchte. Gestell aus hoch hitzebeständigem Technopolymer. Diffusor aus hitzebeständigem sandgestrahltem Glas.

ES Lámpara de pared/plafón. Montura de tecnopolímero de elevada resistencia térmica. Difusor de vidrio arenado resistente al calor.

lampadine / bulbs / ampoules / Glühbirnen / bombillas



○ 1LED - 8W (3000 K, CRI 80, 650 Lm)

Lampada da incasso / Recessed lamp / Encastrable lampe / Einbauleuchte / Lámpara empotrable

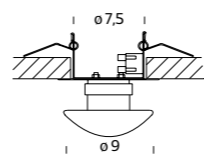

5
6
ø7,5
ø9

2969/2G

IT Lampada da parete/plafone a bassa tensione. Montatura in tecnopolimero a elevata resistenza termica. Diffusore in vetro sabbiato termoresistente. Trasformatore non incluso.

EN Low voltage wall/ceiling lamp. High heat-resistant technopolymer frame. Heat-resistant sandblasted glass diffuser. Ballast not included.

FR Applique/plafonnier à basse tension. Structure en technopolymère à résistance thermique élevée. Diffuseur en verre sablé thermorésistant. Transformateur non fourni.

DE Niederspannung- Wand- und Deckenleuchte. Gestell aus hoch hitzebeständigem Technopolymer. Diffusor aus hitzebeständigem sandgestrahltem Glas. Vorschaltgerät nicht beigelegt.

ES Lámpara de pared/plafón de baja tensión. Montura de tecnopolímero de elevada resistencia térmica. Difusor de vidrio arenado resistente al calor. Transformador no incluido.

lampadine / bulbs / ampoules / Glühbirnen / bombillas



☞ 1×20W (HA) G4 12V or
☞ 1×14W (HA) (ES) G4 12V

IT EN FR DE ES

2969/5G

IT Lampada da parete/plafone a bassa tensione. Montatura in tecnopolimero a elevata resistenza termica. Diffusore in vetro sabbiato termoresistente. Trasformatore non incluso.

EN Low voltage wall/ceiling lamp. High heat-resistant technopolymer frame. Heat-resistant sandblasted glass diffuser. Ballast not included.

FR Applique/plafonnier à basse tension. Structure en technopolymère à résistance thermique élevée. Diffuseur en verre sablé thermorésistant. Transformateur non fourni.

DE Niederspannung- Wand- und Deckenleuchte. Gestell aus hoch hitzebeständigem Technopolymer. Diffusor aus hitzebeständigem sandgestrahltem Glas. Vorschaltgerät nicht beigelegt.

ES Lámpara de pared/plafón de baja tensión. Montura de tecnopolímero de elevada resistencia térmica. Difusor de vidrio arenado resistente al calor. Transformador no incluido.

lampadine / bulbs / ampoules / Glühbirnen / bombillas



☞ 1×50W (HA) GY6.35 12V or
☞ 1×35W (HA) (ES) GY6.35 12V

SILLABONE

pag. 270

Lampada da parete e plafone / Wall and ceiling lamp / Applique ou plafonnier / Wand-order und Deckenleuchte / Aplique y plafón

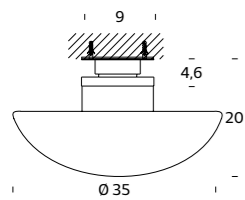

2793G

Lampada da parete/plafone. Montatura in metallo. Diffusore in vetro sabbato termoresistente.

Wall/ceiling lamp. Metal frame. Heat-resistant sandblasted glass diffuser.

Applique/plafonnier. Structure en métal. Diffuseur en verre sablé thermorésistant.

Wand-/Deckenleuchte. Gestell aus Metall. Diffusor aus hitzebeständigem sandgestrahltem Glas.

Lámpara de pared/plafón. Montura de metal. Difusor de vidrio arenado termorresistente.

lampadine / bulbs / ampoules / Glühbirnen / bombillas



1x100W (HA) E27

SIMPLE WHITE

pag. 272

Lampada da parete / Wall lamp / Applique / Wandleuchte / Aplique

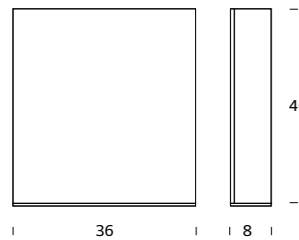

3027...

Lampada da parete. Montatura in metallo verniciato bianco. Diffusore in vetro curvato bianco opale VBI o stampato VST.

Wall lamp. White-painted metal frame. Diffuser in opaline white VBI or pressed VST curved glass.

Applique. Structure en métal peint en blanc. Diffuseur en verre courbé blanc opale VBI ou moulé VST.

Wandlampe. Gestell aus weiß lackiertem Metall. Diffusor aus gebogenem weißem Opalglas VBI oder Pressglas VST.

Lámpara de pared. Montura de metal pintado blanco. Difusor de vidrio curvado blanco opalino VBI o grabado VST.

lampadine / bulbs / ampoules / Glühbirnen / bombillas



1x36W (FL) 2G10

SIMPLICITY

pag. 274

Lampada da parete / Wall lamp / Applique Wandleuchte / Aplique

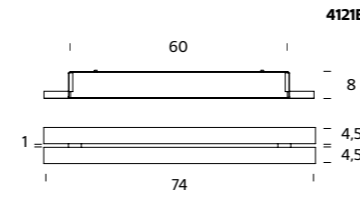

4121BI

Lampada da parete. Montatura in acciaio verniciato lucido bianco. Diffusori in vetro temperato e sabbato.

Wall lamp. Steel frame with white gloss finish. Diffusers in tempered and sandblasted glass.

Applique. Structure en acier verni blanc poli. Diffuseurs en verre trempé et sablé.

Wandleuchte. Gestell aus weiß Hochglanz lackiertem Stahl. Diffusoren aus getempertem und sandgestrahltem Glas.

Lámpara de pared. Montura de acero pintado blanco brillante. Difusores de vidrio templado y arenado.

lampadine / bulbs / ampoules / Glühbirnen / bombillas



1x14/24W (FL) G5

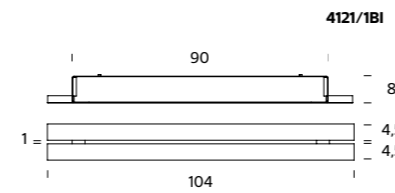

4121/1BI

Lampada da parete. Montatura in acciaio verniciato lucido bianco. Diffusori in vetro temperato e sabbato.

Wall lamp. Steel frame with white gloss finish. Diffusers in tempered and sandblasted glass.

Applique. Structure en acier verni blanc poli. Diffuseurs en verre trempé et sablé.

Wandleuchte. Gestell aus weiß Hochglanz lackiertem Stahl. Diffusoren aus getempertem und sandgestrahltem Glas.

Lámpara de pared. Montura de acero pintado blanco brillante. Difusores de vidrio templado y arenado.

lampadine / bulbs / ampoules / Glühbirnen / bombillas



1x39W (FL) G5

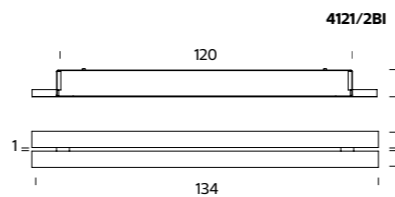

4121/2BI

Lampada da parete. Montatura in acciaio verniciato lucido bianco. Diffusori in vetro temperato e sabbato.

Wall lamp. Steel frame with white gloss finish. Diffusers in tempered and sandblasted glass.

Applique. Structure en acier verni blanc poli. Diffuseurs en verre trempé et sablé.

Wandleuchte. Gestell aus weiß Hochglanz lackiertem Stahl. Diffusoren aus getempertem und sandgestrahltem Glas.

Lámpara de pared. Montura de acero pintado blanco brillante. Difusores de vidrio templado y arenado.

lampadine / bulbs / ampoules / Glühbirnen / bombillas



1x54W (FL) G5

SLOT

pag. 318

Architectural



Serie di lampade da incasso per parete o soffitto per un'illuminazione a luce indiretta. L'apparecchio ha una struttura in metallo. Verniciata a polveri epossidiche colore bianco opaco in cui sono alloggiata una o più lampade fluorescenti dimmerabili. L'apparecchio è caratterizzato dalla facilità di montaggio e manutenzione grazie ad un coperchio tenuto in posizione da calamite in neodimio. L'essenzialità del design consente un effetto luminoso simile ad un taglio di luce su una parete. Questo fa di Slot un prodotto particolarmente adatto a spazi privati e pubblici dove è richiesto, oltre all'illuminazione un effetto decorativo, non invasivo. L'apparecchio è dotato di alimentazione elettronica dimmerabile (1-10V) e può essere montato con o senza cassaforma (indispensabile in presenza di controsoffitti in cartongesso). Una corretta installazione prevede una fessura di 4 mm su tutti i lati perimetrali.



Series of recessed wall or ceiling lamps for indirect light emission. Matte white epoxy powder-coated metal frame housing fluorescent dimmable bulbs. A cover held in place by neodymium magnets makes the fixture easy to assemble and maintain. The minimal design creates a lighting effect similar to a spotlight beam on a wall. This makes Slot especially suitable for private and public spaces that require non-invasive yet decorative lighting effects. Slot fits a dimmable electronic power supply (1-10V) and can be mounted with or without its housing (required for plasterboard false ceilings). For correct installation the lamp includes a 4mm-slit on all 4 sides.

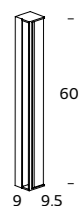

Série d'appiques et de plafonniers à encastrer pour un éclairage indirect. L'appareil a une structure en métal peinte à la poudre époxy blanc mat où sont placées une ou plusieurs lampes fluorescentes graduables. L'appareil est caractérisé par sa facilité de montage et d'entretien, grâce à un couvercle maintenu en place par des aimants en néodyme. Le design épuré permet un effet lumineux semblable à une découpe de lumière sur un mur. Cela fait de Slot un article particulièrement adapté aux espaces privés et publics où un effet décoratif non invasif est requis en plus de l'éclairage. L'appareil comprend une alimentation électronique réglable (1-10V). La lampe peut être montée avec ou sans coffre (indispensable en cas de faux plafond en placoplâtre). Une bonne installation prévoit une fissure de 4 mm sur tous les côtés du périmètre.



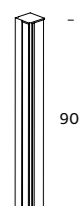

Serie von Wand- oder Deckeneinbauleuchten für indirekte Beleuchtung. Die Leuchte hat eine Metallstruktur. Mit Epoxypulver matt weiß lackiert, enthält sie eine oder mehrere dimmbare Leuchtstofflampen. Das Gerät ist einfach zu montieren und wartungsfreundlich, da seine Abdeckung durch Neodymmagneten festgehalten wird. Durch die Essenzialität des Designs kann ein Lichteffect erzielt werden, der wie ein Lichteinschnitt auf der Wand aussieht. Dadurch eignet sich Slot insbesondere für private und öffentliche Räume, in denen neben der Beleuchtung auch ein unaufdringlicher Dekorationseffekt erwünscht ist. Das Gerät ist mit dimmbarem elektronischem Netzanschluß (1-10V) und kann mit oder ohne Gehäuse montiert werden (bei Einbau in Hängedecken aus Gipsplatte allerdings unerlässlich). Eine korrekte Installation sieht einen Spalt von 4 mm an allen Außenseiten vor.

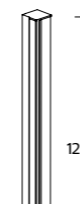



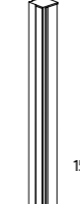

Serie de lámparas empotrables de pared o de techo para iluminar con luz indirecta. El aparato incluye una estructura de metal pintada con polvo epoxy de color blanco en la que se alojan una o varias luces fluorescentes de intensidad regulable. Gracias a la presencia de una tapa que se mantiene en su posición con un imán de neodimio, resulta particularmente fácil de montar y de limpiar. La esencialidad del diseño produce un efecto luminoso similar a una raja de luz en la pared, lo que convierte a Slot en un producto particularmente adecuado para los espacios públicos y privados en los que, además de la iluminación, se requiere un efecto decorativo no invasivo. El aparato está dotado de alimentación electrónica de intensidad luminosa regulable (1-10V) y puede montarse con o sin carcasa (indispensable en presencia de techos falsos de escayola). Para instalarla correctamente, la lámpara debe tener una fisura de 4 mm en los cuatro lados de su perímetro.

	IT	EN	FR	DE	ES
	Alimentatore elettronico dimmerabile incluso (1:10V).	Dimmable electronic ballast included (1:10V).	Alimentateur électronique réglable inclus (1:10V).	Elektronisches Vorschaltgerät mit Dimmer inbegriffen (1:10V).	Alimentador electrónico con dimer incluido (1:10V)
	3749 Corpo 9,5×9,5×60	3749 Body 9,5×9,5×60	3749 Corps 9,5×9,5×60	3749 Körper 9,5×9,5×60	3749 Cuerpo 9,5×9,5×60
	+ 3750 Cassaforma per cartongesso 10×10,5×61 or	+ 3750 Housing for plasterboard 10×10,5×61 or	+ 3750 Boîte d'encastrement pour placoplâtre 10×10,5×61 or	+ 3750 Schalung zum Einbau in Gipsplatten 10×10,5×61 or	+3750 Carcasa para escayola 10×10,5×61 or
	+ 3862 Cassaforma per muro pieno 10×10,5×61	+ 3862 Housing for concrete wall 10×10,5×61	+ 3862 Boîte d'encastrement pour mur plein 10×10,5×61	+ 3862 Schalung für Wand 10×10,5×61	+3862 Carcasa para pared de cemento 10×10,5×61
<p>lampadine / bulbs / ampoules / Glühbirnen / bombillas</p> <p>  1×14W (FL) G5 FH or  1×24W (FL) G5 FQ </p>					

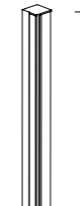
	IT	EN	FR	DE	ES
	Alimentatore elettronico dimmerabile incluso (1:10V).	Dimmable electronic ballast included (1:10V).	Alimentateur électronique réglable inclus (1:10V).	Elektronisches Vorschaltgerät mit Dimmer inbegriffen (1:10V).	Alimentador electrónico con dimer incluido (1:10V)
	3749/1 Corpo 9,5×9,5×90	3749/1 Body 9,5×9,5×90	3749/1 Corps 9,5×9,5×90	3749/1 Körper 9,5×9,5×90	3749/1 Cuerpo 9,5×9,5×90
	+ 3750/1 Cassaforma per cartongesso 10×10,5×91 or	+ 3750/1 Housing for plasterboard 10×10,5×91 or	+ 3750/1 Boîte d'encastrement pour placoplâtre 10×10,5×91 or	+ 3750/1 Schalung zum Einbau in Gipsplatte 10×10,5×91 or	+3750/1 Carcasa para escayola 10×10,5×91 or
	+ 3862/1 Cassaforma per muro pieno 10×10,5×91	+ 3862/1 Housing for concrete wall 10×10,5×91	+ 3862/1 Boîte d'encastrement pour mur plein 10×10,5×91	+ 3862/1 Schalung für Wand 10×10,5×91	+3862/1 Carcasa para pared de cemento 10×10,5×91
<p>lampadine / bulbs / ampoules / Glühbirnen / bombillas</p> <p>  1×21W G5 FH or  1×39W (FL) G5 FQ </p>					

	IT	EN	FR	DE	ES
	Alimentatore elettronico dimmerabile incluso (1:10V).	Dimmable electronic ballast included (1:10V).	Alimentateur électronique réglable inclus (1:10V).	Elektronisches Vorschaltgerät mit Dimmer inbegriffen (1:10V).	Alimentador electrónico con dimer incluido (1:10V)
	3749/2 Corpo 9,5×9,5×120	3749/2 Body 9,5×9,5×120	3749/2 Corps 9,5×9,5×120	3749/2 Körper 9,5×9,5×120	3749/2 Cuerpo 9,5×9,5×120
	+ 3750/2 Cassaforma per cartongesso 10×10,5×121 or	+ 3750/2 Housing for plasterboard 10×10,5×121 or	+ 3750/2 Boîte d'encastrement pour placoplâtre 10×10,5×121 or	+ 3750/2 Schalung zum Einbau in Gipsplatten 10×10,5×121 or	+ 3750/2 Carcasa para escayola 10×10,5×121 or
	+ 3862/2 Cassaforma per muro pieno 10×10,5×121	+ 3862/2 Housing for concrete wall 10×10,5×121	+ 3862/2 Boîte d'encastrement pour mur plein 10×10,5×121	+ 3862/2 Schalung für Wand 10×10,5×121	+ 3862/2 Carcasa para pared de cemento 10×10,5×121
<p>lampadine / bulbs / ampoules / Glühbirnen / bombillas</p> <p>  1×28W (FL) G5 FH or  1×54W (FL) G5 FQ </p>					

	IT	EN	FR	DE	ES
	Alimentatore elettronico dimmerabile incluso (1:10V).	Dimmable electronic ballast included (1:10V).	Alimentateur électronique réglable inclus (1:10V).	Elektronisches Vorschaltgerät mit Dimmer inbegriffen (1:10V).	Alimentador electrónico con dimer incluido (1:10V)
	3749/3 Corpo 9,5×9,5×150	3749/3 Body 9,5×9,5×150	3749/3 Corps 9,5×9,5×150	3749/3 Körper 9,5×9,5×150	3749/3 Cuerpo 9,5×9,5×150
	+ 3750/3 Cassaforma per cartongesso 10×10,5×151 or	+ 3750/3 Housing for plasterboard 10×10,5×151 or	+ 3750/3 Boîte d'encastrement pour placoplâtre 10×10,5×151 or + 3862/3	+ 3750/3 Schalung zum Einbau in Gipsplatten 10×10,5×151 or	+ 3750/3 Carcasa para escayola 10×10,5×151 or
	+ 3862/3 Cassaforma per muro pieno 10×10,5×151	+ 3862/3 Housing for concrete wall 10×10,5×151	+ 3862/3 Boîte d'encastrement pour mur plein 10×10,5×151	+ 3862/3 Schalung für Wand 10×10,5×151	+ 3862/3 Carcasa para pared de cemento 10×10,5×151
<p>lampadine / bulbs / ampoules / Glühbirnen / bombillas</p> <p>  1×35W (FL) G5 FH or  1×49W (FL) G5 FQ or  1×80W (FL) G5 FQ </p>					

	IT	EN	FR	DE	ES
	Alimentatore elettronico dimmerabile incluso (1:10V).	Dimmable electronic ballast included (1:10V).	Alimentateur électronique réglable inclus (1:10V).	Elektronisches Vorschaltgerät mit Dimmer inbegriffen (1:10V).	Alimentador electrónico con dimer incluido (1:10V)
	3749/4 Corpo 9,5×9,5×247	3749/4 Body 9,5×9,5×247	3749/4 Corps 9,5×9,5×247	3749/4 Körper 9,5×9,5×247	3749/4 Cuerpo 9,5×9,5×247
	+ 3750/4 Cassaforma per cartongesso 10×10,5×248 or	+ 3750/4 Housing for plasterboard 10×10,5×248 or	+ 3750/4 Boîte d'encastrement pour placoplâtre 10×10,5×248 or	+ 3750/4 Schalung zum Einbau in Gipsplatten 10×10,5×248 or	+ 3750/4 Carcasa para escayola 10×10,5×248 or
	+ 3862/4 Cassaforma per muro pieno 10×10,5×248	+ 3862/4 Housing for concrete wall 10×10,5×248	+ 3862/4 Boîte d'encastrement pour mur plein 10×10,5×248	+ 3862/4 Schalung für Wand 10×10,5×248	+ 3862/4 Carcasa para pared de cemento 10×10,5×248
<p>lampadine / bulbs / ampoules / Glühbirnen / bombillas</p> <p>  1×35W (FL) G5 FH or  1×49W (FL) G5 FQ or  1×80W (FL) G5 FQ </p> <p>+</p> <p>  1×28W (FL) FH or  1×54W (FL) G5 FQ </p>					

Installazione su cartongesso / Installation on plasterboard / Montage en placoplâtre / Installation an hängedecke aus gipsplatte / Instalación en escayola

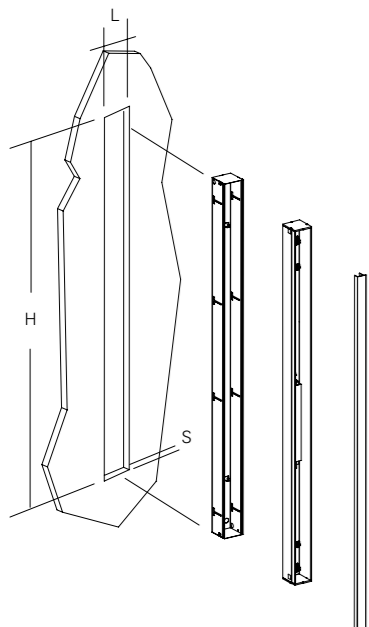

Apparecchio / Fixture / Appareil / Gerät / Aparato	3749	3749/1	3749/2	3749/3	3749/4
Cassaforma / Housing Coffre / Gehäuse / Carcasa	3750	3750/1	3750/2	3750/3	3750/4
H	61 cm	91 cm	121 cm	151 cm	248 cm
S	max 4,2 cm	max 4,2 cm	max 4,2 cm	max 4,2 cm	max 4,2 cm
L	10,5 cm	10,5 cm	10,5 cm	10,5 cm	10,5 cm

Installazione su muro pieno / Installation on solid wall / Montage sur mur plein / Installation auf vollem Wand / Montage en pared de ladrillos

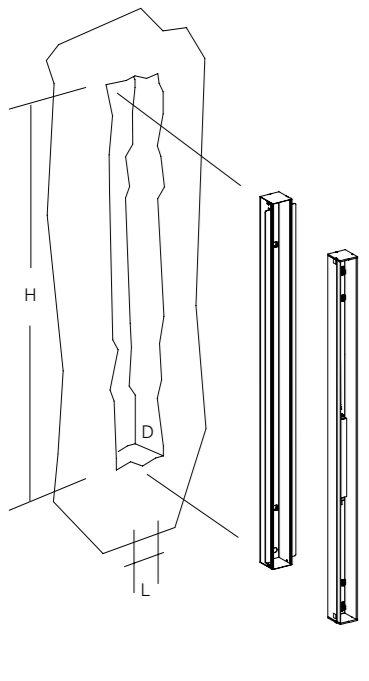

Apparecchio / Fixture / Appareil / Gerät / Aparato	3749	3749/1	3749/2	3749/3	3749/4
Cassaforma / Housing Coffre / Gehäuse / Carcasa	3862	3862/1	3862/2	3862/3	3862/4
H	61 cm	91 cm	121 cm	151 cm	248 cm
S	10 cm	10 cm	10 cm	10 cm	10 cm
L	16,5 cm	16,5 cm	16,5 cm	16,5 cm	16,5 cm

Lampada da parete e plafone / Wall and ceiling lamp / Applique ou plafonnier / Wand-order und Deckenleuchte / Aplique y plafón

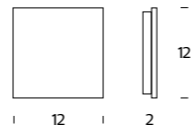

IT	EN	FR	DE	ES
Lampada da parete/plafone. Corpo in polimero plastico bianco opaco. Diffusore in vetro extrachiaro serigrafato. L'apparecchio è facile da installare: la scheda a LED, infatti, funziona a tensione di rete e pertanto non richiede un trasformatore. Dimmerabile con apposito light dimmer (non fornito).	Wall/ceiling lamp. Matte Body in white opaque plastic polymer. Screen-printed extra-clear glass diffuser. Easy-to-install lighting fixture with a LED board for mains voltage operation that does not require a transformer. Dimmable with remote light dimmer (not supplied).	Applique/plafonnier. Corps en polymère plastique opaque blanc. Diffuseur en verre extra-clair sérigraphié. L'appareil est facile à installer: la fiche à LED fonctionne à la tension de réseau et ne demande donc pas de transformateur. Variation de lumière possible par module externe (non fourni).	Wand- und Deckenleuchte. Leuchtenkörper aus mattem weißem Polymer. Diffusor aus extraklarem Siebdruckglas. Die Lampe ist leicht zu installieren: die LED- Platine funktioniert mit Netzspannung und benötigt daher keinen Trafo. Dimmbar mit separaten Dimmer (nicht im Lieferumfang enthalten).	Lámpara de pared/plafón. Cuerpo de polímero plástico mate blanco. Difusor de vidrio extraclaro serigrafado. El aparato es fácil de instalar: la tarjeta de LED funciona con tensión de red, por lo que no requiere el uso de un transformador. Dimerable con un dimer remoto (no incluido).

4140 lampadine / bulbs / ampoules / Glühbirnen / bombillas

CE IP44 Classe II ENEC ENEC ENEC A+ INCL LED NOT REPLACEABLE

○ 144 LED - 9W (3000 K, CRI>85, 800 Lm)

4146 lampadine / bulbs / ampoules / Glühbirnen / bombillas

CE IP44 Classe II ENEC ENEC A+ INCL LED NOT REPLACEABLE

○ 144 LED - 9W (4000 K, CRI>85, 800 Lm)

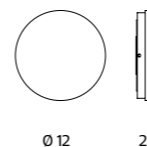

Lampada da parete/plafone. Corpo in polimero plastico bianco opaco. Diffusore in vetro extrachiaro serigrafato. L'apparecchio è facile da installare: la scheda a LED, infatti, funziona a tensione di rete e pertanto non richiede un trasformatore. Dimmerabile con apposito light dimmer (non fornito).	Wall/ceiling lamp. Matte Body in white opaque plastic polymer. Screen-printed extra-clear glass diffuser. Easy-to-install lighting fixture with a LED board for mains voltage operation that does not require a transformer. Dimmable with remote light dimmer (not supplied).	Applique/plafonnier. Corps en polymère plastique opaque blanc. Diffuseur en verre extra-clair sérigraphié. L'appareil est facile à installer: la fiche à LED fonctionne à la tension de réseau et ne demande donc pas de transformateur. Variation de lumière possible par module externe (non fourni).	Wand- und Deckenleuchte. Leuchtenkörper aus mattem weißem Polymer. Diffusor aus extraklarem Siebdruckglas. Die Lampe ist leicht zu installieren: die LED- Platine funktioniert mit Netzspannung und benötigt daher keinen Trafo. Dimmbar mit separaten Dimmer (nicht im Lieferumfang enthalten).	Lámpara de pared/plafón. Cuerpo de polímero plástico mate blanco. Difusor de vidrio extraclaro serigrafado. El aparato es fácil de instalar: la tarjeta de LED funciona con tensión de red, por lo que no requiere el uso de un transformador. Dimerable con un dimer remoto (no incluido).
------------------------------------------------------------------------------------------------------------------------------------------------------------------------------------------------------------------------------------------------------------------------------------------------------------	--------------------------------------------------------------------------------------------------------------------------------------------------------------------------------------------------------------------------------------------------------------------------------	---------------------------------------------------------------------------------------------------------------------------------------------------------------------------------------------------------------------------------------------------------------------------------------------------------	--------------------------------------------------------------------------------------------------------------------------------------------------------------------------------------------------------------------------------------------------------------------------------------------------	---------------------------------------------------------------------------------------------------------------------------------------------------------------------------------------------------------------------------------------------------------------------------------------------

4141 lampadine / bulbs / ampoules / Glühbirnen / bombillas

CE IP44 Classe II ENEC ENEC A+ INCL LED NOT REPLACEABLE

○ 144 LED - 9W (3000 K, CRI>85, 800 Lm)

4243 lampadine / bulbs / ampoules / Glühbirnen / bombillas

CE IP44 Classe II ENEC ENEC A+ INCL LED NOT REPLACEABLE

○ 144 LED - 9W (4000 K, CRI>85, 800 Lm)

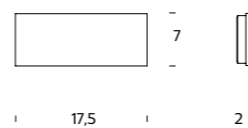

Lampada da parete/plafone. Corpo in polimero plastico bianco opaco. Diffusore in vetro extrachiaro serigrafato. L'apparecchio è facile da installare: la scheda a LED, infatti, funziona a tensione di rete e pertanto non richiede un trasformatore. Dimmerabile con apposito light dimmer (non fornito).	Wall/ceiling lamp. Matte Body in white opaque plastic polymer. Screen-printed extra-clear glass diffuser. Easy-to-install lighting fixture with a LED board for mains voltage operation that does not require a transformer. Dimmable with remote light dimmer (not supplied).	Applique/plafonnier. Corps en polymère plastique opaque blanc. Diffuseur en verre extra-clair sérigraphié. L'appareil est facile à installer: la fiche à LED fonctionne à la tension de réseau et ne demande donc pas de transformateur. Variation de lumière possible par module externe (non fourni).	Wand- und Deckenleuchte. Leuchtenkörper aus mattem weißem Polymer. Diffusor aus extraklarem Siebdruckglas. Die Lampe ist leicht zu installieren: die LED- Platine funktioniert mit Netzspannung und benötigt daher keinen Trafo. Dimmbar mit separaten Dimmer (nicht im Lieferumfang enthalten).	Lámpara de pared/plafón. Cuerpo de polímero plástico mate blanco. Difusor de vidrio extraclaro serigrafado. El aparato es fácil de instalar: la tarjeta de LED funciona con tensión de red, por lo que no requiere el uso de un transformador. Dimerable con un dimer remoto (no incluido).
------------------------------------------------------------------------------------------------------------------------------------------------------------------------------------------------------------------------------------------------------------------------------------------------------------	--------------------------------------------------------------------------------------------------------------------------------------------------------------------------------------------------------------------------------------------------------------------------------	---------------------------------------------------------------------------------------------------------------------------------------------------------------------------------------------------------------------------------------------------------------------------------------------------------	--------------------------------------------------------------------------------------------------------------------------------------------------------------------------------------------------------------------------------------------------------------------------------------------------	---------------------------------------------------------------------------------------------------------------------------------------------------------------------------------------------------------------------------------------------------------------------------------------------

4142 lampadine / bulbs / ampoules / Glühbirnen / bombillas

CE IP44 Classe II ENEC ENEC A+ INCL LED NOT REPLACEABLE

○ 144 LED - 9W (3000 K, CRI>85, 800 Lm)

4245 lampadine / bulbs / ampoules / Glühbirnen / bombillas

CE IP44 Classe II ENEC ENEC A+ INCL LED NOT REPLACEABLE

○ 144 LED - 9W (4000 K, CRI>85, 800 Lm)

THOR

pag. 278

Lampada da tavolo / Table lamp / Lampe de table / Tischleuchte / Lámpara de sobremesa

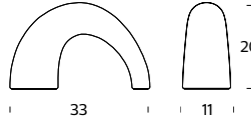
IT	EN	FR	DE	ES	
 <p>3295/0</p>	<p>Lampada da tavolo. Montatura in metallo verniciato bianco. Diffusore in vetro soffiato bianco opalino. Cavo di alimentazione, interruttore e spina trasparenti.</p>	<p>Table lamp. Metal frame in white finish. Opaline white blown glass diffuser. Transparent power cable, switch and plug.</p>	<p>Lampe de table. Structure en métal peint en blanc. Diffuseur en verre soufflé couleur blanc opalin. Câble d'alimentation, interrupteur et fiche transparents.</p>	<p>Tischleuchte. Metallgestell weiß lackiert. Diffusor aus weißem mundgeblasenem Opalglas. Netzkabel, Schalter und Netzstecker transparent.</p>	<p>Lámpara de sobremesa. Montura de metal pintado blanco. Difusor de vidrio soplado blanco opalino. Cable de alimentación, interruptor y enchufe transparentes.</p>

lampadine / bulbs / ampoules / Glühbirnen / bombillas



- 1x40W (IN) E14 or
- 1x8W (FL) E14

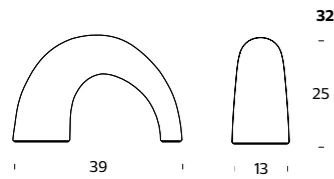

3295

Lampada da tavolo. Montatura in metallo verniciato bianco. Diffusore in vetro soffiato bianco opalino. Cavo di alimentazione, interruttore e spina trasparenti.

Table lamp. Metal frame in white finish. Opaline white blown glass diffuser. Transparent power cable, switch and plug.

Lampe de table. Structure en métal peint en blanc. Diffuseur en verre soufflé couleur blanc opalin. Câble d'alimentation, interrupteur et fiche transparents.

Tischleuchte. Metallgestell weiß lackiert. Diffusor aus weißem mundgeblasenem Opalglas. Netzkabel, Schalter und Netzstecker transparent.

Lámpara de sobremesa. Montura de metal pintado blanco. Difusor de vidrio soplado blanco opalino. Cable de alimentación, interruptor y enchufe transparentes.

lampadine / bulbs / ampoules / Glühbirnen / bombillas



- 1x60W (IN) E27 or
- 1x16W (FL) E27

TUBO LED

pag. 280

Lampada a sospensione / Suspension lamp / Suspension / Pendelleuchte / Suspensión

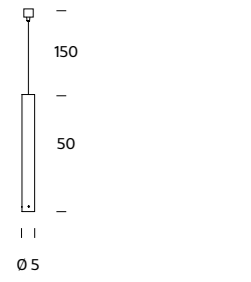
IT	EN	FR	DE	ES	
 <p>4138</p>	<p>Lampada a sospensione. Corpo in vetro borosilicato trasparente che alloggia al suo interno un dissipatore in metallo anodizzato naturale, alettato, che consente una migliore dispersione del calore prodotto dalla sorgente luminosa. Cavo di alimentazione trasparente, regolabile in altezza. Alimentatore elettronico incluso.</p>	<p>Suspension lamp. Transparent borosilicate glass body housing a natural anodized finned metal dissipator for enhanced dissipation of heat produced by the light source. Transparent height-adjustable power cable. Electronic ballast included.</p>	<p>Suspension. Corps en verre borosilicate transparent qui abrite à l'intérieur un dissipateur en métal anodisé naturel, à ailettes, qui permet une meilleure dissipation de la chaleur produite par la source de lumière. Câble d'alimentation transparent, réglable en hauteur. Alimentation électronique incluse.</p>	<p>Hängeleuchte. Leuchtkörper aus transparentem Borosilikatglas, der in seinem Inneren einen gerippten Kühlkörper aus natur eloxiertem Metall aufweist, welcher eine bessere Dispersion der von der Lichtquelle ausgestrahlten Wärme gestattet. Transparentes höhenverstellbares Stromkabel. Netzteil inbegriffen.</p>	<p>Lámpara de techo. El cuerpo de vidrio borosilicato transparente aloja en su interior un disipador de metal anodizado natural, con aletas, que permite una mejor dispersión del calor producido por la fuente luminosa. Cable de alimentación transparente, regulable en altura. Alimentador electrónico incluido.</p>

lampadine / bulbs / ampoules / Glühbirnen / bombillas



- 1 LED - 14W (2700 K, CRI 82, 1100 Lm)

UOVO

pag. 282 (outdoor pag. 338)

Lampada da tavolo / Table lamp / Lampe de table / Tischleuchte / Lámpara de sobremesa

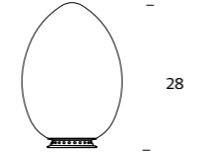
IT	EN	FR	DE	ES	
 <p>2646/0</p>	<p>Lampada da tavolo. Montatura in metallo verniciato bianco. Diffusore in vetro soffiato bianco satinato. Cavo di alimentazione, interruttore e spina neri.</p>	<p>Table lamp. Metal frame in white finish. Frosted white blown glass diffuser. Black power cable, plug and switch.</p>	<p>Lampe de table. Structure en métal peint en blanc. Diffuseur en verre soufflé blanc satiné. Câble d'alimentation, fiche et interrupteur noirs.</p>	<p>Tischleuchte. Gestell aus weiß lackiertem Metall. Diffusor aus weißem, mundgeblasenem und satiniertem Glas. Netzkabel, Netzstecker und Schalter schwarz.</p>	<p>Lámpara de sobremesa. Montura de metal pintado blanco. Difusor de vidrio soplado blanco satinado. Cable de alimentación, enchufe y interruptor negros.</p>

lampadine / bulbs / ampoules / Glühbirnen / bombillas



- 1x40W (IN) E27 or
- 1x12W (FL) E27

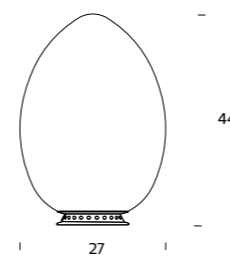

2646/1

Lampada da tavolo. Montatura in metallo verniciato bianco. Diffusore in vetro soffiato bianco satinato. Cavo di alimentazione, dimmer e spina neri.

Table lamp. Metal frame in white finish. Frosted white blown glass diffuser. Black power cable, plug and dimmer.

Lampe de table. Structure en métal peint en blanc. Diffuseur en verre soufflé blanc satiné. Câble d'alimentation, fiche et variateur noirs.

Tischleuchte. Gestell aus weiß lackiertem Metall. Diffusor aus weißem, mundgeblasenem und satiniertem Glas. Netzkabel, Netzstecker und Dimmer schwarz.

Lámpara de sobremesa. Montura de metal pintado blanco. Difusor de vidrio soplado blanco satinado. Cable de alimentación, enchufe y dimer negros.

lampadine / bulbs / ampoules / Glühbirnen / bombillas



- 1x75W (IN) E27 or
- 1x70W (HA) E27

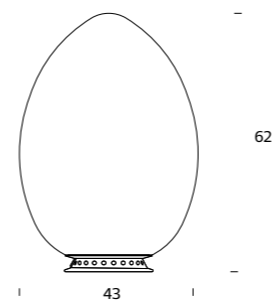

2646

Lampada da tavolo. Montatura in metallo verniciato bianco. Diffusore in vetro soffiato bianco satinato. Cavo di alimentazione, dimmer e spina neri.

Table lamp. Metal frame in white finish. Frosted white blown glass diffuser. Black power cable, plug and dimmer.

Lampe de table. Structure en métal peint en blanc. Diffuseur en verre soufflé blanc satiné. Câble d'alimentation, fiche et variateur noirs.

Tischleuchte. Gestell aus weiß lackiertem Metall. Diffusor aus weißem, mundgeblasenem und satiniertem Glas. Netzkabel, Netzstecker und Dimmer schwarz.

Lámpara de sobremesa. Montura de metal pintado blanco. Difusor de vidrio soplado blanco satinado. Cable de alimentación, enchufe y dimer negros.

lampadine / bulbs / ampoules / Glühbirnen / bombillas



- 1x100W (HA) E27

Lampada da parete / Wall lamp / Applique Wandleuchte / Applique

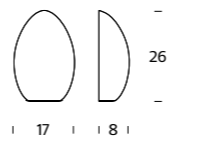
IT	EN	FR	DE	ES	
 <p>3633/0</p>	<p>Lampada da parete. Montatura in acciaio verniciato bianco. Diffusore in vetro soffiato bianco opalino.</p>	<p>Wall lamp. White-painted steel frame. Diffuser in white opaline blown glass.</p>	<p>Applique. Structure en acier peint en blanc. Diffuseur en verre soufflé blanc opalin.</p>	<p>Wandleuchte. Gestell aus weiß lackiertem Stahl. Diffusor aus weißem mundgeblasenem Opalglas.</p>	<p>Lámpara de pared. Montura de acero pintado blanco. Difusor de vidrio soplado blanco opalino.</p>

lampadine / bulbs / ampoules / Glühbirnen / bombillas



- 1x60W (HA) G9

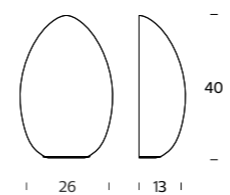

3633/1

Lampada da parete. Montatura in acciaio verniciato bianco. Diffusore in vetro soffiato bianco opalino.

Wall lamp. White-painted steel frame. Diffuser in white opaline blown glass.

Applique. Structure en acier peint en blanc. Diffuseur en verre soufflé blanc opalin.

Wandleuchte. Gestell aus weiß lackiertem Stahl. Diffusor aus weißem mundgeblasenem Opalglas.

Lámpara de pared. Montura de acero pintado blanco. Difusor de vidrio soplado blanco opalino.

lampadine / bulbs / ampoules / Glühbirnen / bombillas

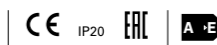

- 1x75W (IN) E27 or
- 1x70W (HA) E27

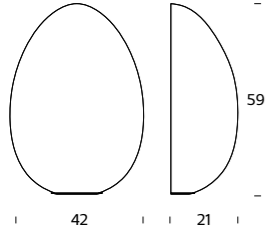
IT	EN	FR	DE	ES	
 <p>3633</p>	<p>Lampada da parete. Montatura in acciaio verniciato bianco. Diffusore in vetro soffiato bianco opalino.</p>	<p>Wall lamp. White-painted steel frame. Diffuser in white opaline blown glass.</p>	<p>Applique. Structure en acier peint en blanc. Diffuseur en verre soufflé blanc opalin.</p>	<p>Wandleuchte. Gestell aus weiß lackiertem Stahl. Diffusor aus weißem mundgeblasenem Opalglas.</p>	<p>Lámpara de pared. Montura de acero pintado blanco. Difusor de vidrio soplado blanco opalino.</p>
<p>lampadine / bulbs / ampoules / Glühbirnen / bombillas</p> <p>CE IP20 ENEC EAC D→E</p> <p>1x100W (HA) E27</p>					

Esterno / Outdoor / Extérieur / Außen / Exterior

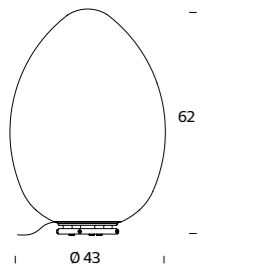
IT	EN	FR	DE	ES	
 <p>3938/1BI</p>	<p>Lampada da tavolo o da terra da esterno. Diffusore in polietilene bianco satinato opalino realizzato con stampaggio rotazionale. Montatura in acciaio inox. Si appoggia al piano grazie alla base in acciaio inox oppure si fissa al terreno grazie a tirafondi. La versione con base è provvista di cavo di alimentazione nero lungo 5 metri e spina in classe di protezione IP 65.</p>	<p>Outdoor table or floor lamp. Diffuser in opaline frosted white polyethylene manufactured by rotational moulding. Stainless steel frame. Installation on a stainless steel base or set into the ground with an anchor rod. The base-mount version comes with a 5 metres of black power cable and IP 65 protection class plug.</p>	<p>Lampe de table ou lampadaire d'extérieur. Diffuseur en polyéthylène blanc satiné opalin réalisé avec moulage rotationnel. Structure en acier inox. Possibilité de la poser sur une surface plane, grâce à sa base en acier inox, ou de la fixer grâce aux tire-fond. La version avec base est fournie avec un câble d'alimentation noir de 5 mètres de long et une fiche en classe de protection IP 65.</p>	<p>Tisch- oder Bodenleuchte für den Außenbereich. Diffusor aus satiniertem opalweißem Polyethylen, das mit Rotationsverfahren hergestellt wurde. Gestell aus Edelstahl. Kann dank der Edelstahlbasis aufgestellt oder im Boden mit Zugstangen befestigt werden. Die Version mit Basis hat ein 5 m langes schwarzes Netzkabel und Netzstecker der Schutzart IP 65.</p>	<p>Lámpara de sobremesa o de pie para exteriores. Difusor de polietileno blanco satinado opalino realizado con moldeo rotacional. Montura de acero inoxidable. Se apoya en la superficie utilizando la base de acero inoxidable o se fija al suelo con tirafondos. La versión con base está equipada con un cable de alimentación negro de 5 metros de longitud y enchufe con clase de protección IP 65.</p>
<p>lampadine / bulbs / ampoules / Glühbirnen / bombillas</p> <p>CE IP65 ENEC A→E</p> <p>1x100W (HA) E27 or 1x30W (FL) E27</p>					

VELO

pag. 288

Lampada da parete / Wall lamp / Applique
Wandleuchte / Applique

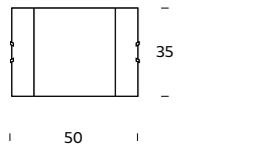
IT	EN	FR	DE	ES	
 <p>2805/0</p>	<p>Lampada da parete. Montatura con porta-lampada e riflettore in alluminio brillantato. Diffusore in vetro curvato dello spessore di 3 mm indurito e sabbiato. Schermo di protezione per lampadina alogena in vetro borosilicato sabbiato.</p>	<p>Wall lamp. Frame with buffed aluminium lamp holder and reflector. Tempered, sandblasted, 3 mm-thick curved glass diffuser. Halogen bulb shield in sandblasted borosilicate glass.</p>	<p>Applique. Structure avec douille et réflecteur en aluminium brillanté. Diffuseur en verre courbé (épaisseur 3 mm) durci et sablé. Écran de protection pour ampoule halogène en verre borosilicate sablé.</p>	<p>Wandleuchte. Gestell mit Lampenfassung und Reflektor aus poliertem Aluminium. Diffusor aus gebogenem, gehärtetem und sandgestrahltem Glas. Pantalla de protección para bombilla halógena de vidrio borosilicato arenado.</p>	<p>Lámpara de pared. Montura con portabombilla y reflector de aluminio pulido. Difusor de vidrio curvado de 3 mm endurecido y arenado. Pantalla de protección para bombilla halógena de vidrio borosilicato arenado.</p>
<p>lampadine / bulbs / ampoules / Glühbirnen / bombillas</p> <p>CE IP20 ENEC EAC C→E INCL. C</p> <p>1x160W (HA) R7s/115</p>					

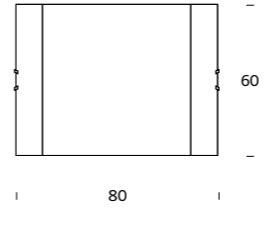
IT	EN	FR	DE	ES	
 <p>2805/1</p>	<p>Lampada da parete. Montatura con porta-lampada e riflettore in alluminio brillantato. Diffusore in vetro curvato dello spessore di 3 mm indurito e sabbiato. Schermo di protezione per lampadina alogena in vetro borosilicato sabbiato.</p>	<p>Wall lamp. Frame with buffed aluminium lamp holder and reflector. Tempered, sandblasted, 3 mm-thick curved glass diffuser. Halogen bulb shield in sandblasted borosilicate glass.</p>	<p>Applique. Structure avec douille et réflecteur en aluminium brillanté. Diffuseur en verre courbé (épaisseur 3 mm) durci et sablé. Écran de protection pour ampoule halogène en verre borosilicate sablé.</p>	<p>Wandleuchte. Gestell mit Lampenfassung und Reflektor aus poliertem Aluminium. Diffusor aus gebogenem, gehärtetem und sandgestrahltem Glas. Stärke 3 mm. Schutzröhre für Halogenleuchtmittel aus sandgestrahltem Borosilikatglas.</p>	<p>Lámpara de pared. Montura con portabombilla y reflector de aluminio pulido. Difusor de vidrio curvado de 3 mm endurecido y arenado. Pantalla de protección para bombilla halógena de vidrio borosilicato arenado.</p>
<p>lampadine / bulbs / ampoules / Glühbirnen / bombillas</p> <p>CE IP20 ENEC EAC C→E INCL. C</p> <p>1x160W (HA) R7s/115</p>					

Lampada a sospensione / Suspension lamp
Suspension / Pendelleuchte / Suspensión

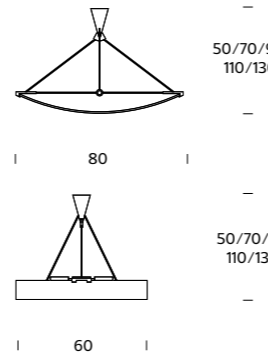
IT	EN	FR	DE	ES	
 <p>2791</p>	<p>Lampada a sospensione. Diffusore in vetro, spessore 3 mm, curvato, indurito e sabbiato. Tubetto di protezione per lampadina alogena in vetro borosilicato sabbiato. Rosone e agganci in alluminio pressofuso cromato. Tiranteria in acciaio spazzolato lucido.</p>	<p>Suspension lamp. Tempered, sandblasted, 3mm-thick curved glass diffuser. Halogen bulb shield in sandblasted borosilicate glass. Die-cast chromed aluminium canopy and hooks. Polished brushed steel rods.</p>	<p>Suspension. Diffuseur en verre, épaisseur 3 mm, courbé, durci et sablé. Tube de protection pour ampoule halogène en verre borosilicate sablé. Rosace et crochets en aluminium moulé sous pression chromé. Tirants en acier brossé poli.</p>	<p>Hängeleuchte. Diffusor aus 3 mm starkem gebogenem, gehärtetem und sandgestrahltem Glas. Schutzröhchen für die Halogenleuchte aus sandgestrahltem Borosilikatglas. Rosette und Aufhänger aus verchromtem Pressguss. Gestänge aus gebürstetem poliertem Stahl.</p>	<p>Lámpara de techo. Difusor de vidrio de 3 mm de grosor, curvado, endurecido y arenado. Tubito de protección para bombilla halógena de vidrio borosilicato arenado. Florón y enganches de aluminio moldeado a presión cromado. Tirantes de acero cepillado brillante.</p>
<p>lampadine / bulbs / ampoules / Glühbirnen / bombillas</p> <p>CE IP20 ENEC C→E INCL. C</p> <p>1x230W (HA) R7s/115</p>					

VERTIGO

pag. 292

Lampada da terra / Floor lamp / Lampadaire /
Stehleuchte / Lámpara de pie

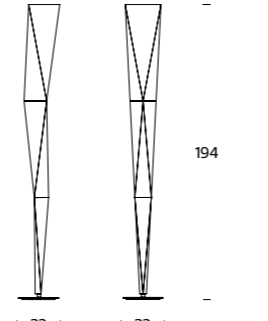
IT	EN	FR	DE	ES	
 <p>5531/ 5531..</p>	<p>Lampada da terra, a luce indiretta, con dimmer. Struttura in lamiera d'alluminio piegata e lucidata a specchio (5531), verniciata bianco BI (RAL 9003 lucido) o nero N (RAL 9005 lucido). Base in metallo verniciato nero opaco. La struttura può ruotare di 320° sul piano orizzontale. Cavo di alimentazione, dimmer e spina neri.</p>	<p>Indirect beam floor lamp with dimmer. Folded, mirror-polished aluminium sheet frame (5531) and white BI (RAL 9003 gloss) or black N (RAL 9005 gloss) finish. Steel base in matteblack finish. The frame rotates 320° horizontally. Black power cable, dimmer and plug.</p>	<p>Lampadaire, à lumière indirecte, avec variateur. Structure en tôle d'aluminium pliée et polie miroir (5531), anodisée BI (RAL 9003 brillante) ou noir N (RAL 9005 brillante). Base en métal peint en noir mat. La structure peut pivoter de 320° sur le plan horizontal. Câble d'alimentation, variateur et fiche noirs.</p>	<p>Stehlampe für indirekte Beleuchtung mit Dimmer. Struktur aus gefaltetem Aluminiumblech, blankpoliert (5531), weiß BI (RAL 9003 glänzend) oder schwarz N (RAL 9005 glänzend). Basis aus matt schwarz lackiertem Metall. Die Struktur lässt sich auf horizontaler Ebene um 320° drehen. Netzkabel, Dimmer und Netzstecker schwarz.</p>	<p>Lámpara de pie, de luz indirecta, con dimer. Estructura de chapa de aluminio doblada y bruñida a espejo (5531), pintada en blanco BI (RAL 9003 brillante) o negro N (RAL 9005 brillante). Base de metal pintado negro mate. La estructura gira 320° sobre el plano horizontal. Cable de alimentación, dimer y enchufe negros.</p>
<p>lampadine / bulbs / ampoules / Glühbirnen / bombillas</p> <p>CE IP20 Classe II ENEC C→E INCL. C</p> <p>1x230W (HA) R7s/115</p>					

<p>4291 / 4291..</p> <p>lampadine / bulbs / ampoules / Glühbirnen / bombillas</p> <p>CE IP20 Classe II ENEC A+ INCL. LED NOT REPLACEABLE</p>				
------------------------------------------------------------------------------------------------------------------------------------------------------------	--	--	--	--

○ LED - 30W (3000 K, CRI 85, 2900 Lm)

VITRO

pag. 294 (outdoor pag. 342)

Esterno / Outdoor / Extérieur / Außen / Exterior

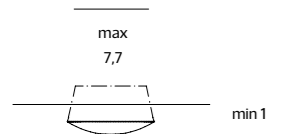
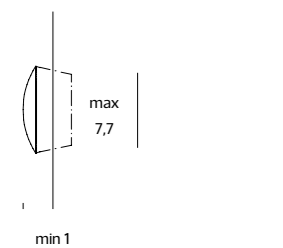
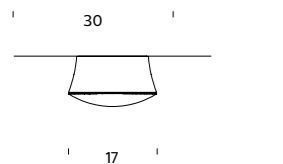
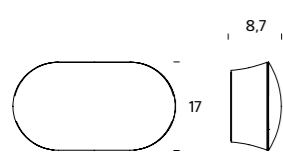

4462...

Lampada da parete e plafone. Corpo in polimero plastico opaco. Diffusore in polimero plastico opalino **VS**, trasparente **TR**. Installabile anche semi-incassata grazie a una dima venduta come accessorio. Dimmerabile con apposito light dimmer (non fornito). Adatta anche per esterno. Dimmerabile con apposito light dimmer (non fornito).

A4262
Dima per installazione a semincasso (dimensione del foro a parete e plafone 27x14,5 cm)

Wall and ceiling lamp. Body in opaque plastic polymer. Diffuser in opaline plastic polymer **VS**, clear **TR**. Can also be semi-recessed thanks to a template sold as an accessory. Dimmable using the specific light dimmer (not included). Also suitable for outdoors. Dimmable with remote light dimmer (not supplied).

A4262
Template for semi-recessed (hole size for wall and ceiling 27x14,5 cm)

Applique et plafonnier. Corps en polymère plastique opaque. Diffuseur en polymère plastique opalin **VS**, transparent **TR**. Peut être semi-encastree grâce à un gabarit disponible en option. Possibilité d'ajouter un variateur de lumière (non fourni). Également indiquée pour l'extérieur. (non fourni).

A4262
Platine pour installation semi-encastree (dimension découpe pour applique et plafond 27x14,5 cm)

Wand- und Deckenleuchte. Leuchtenkörper aus mattem Polymer. Diffusor aus Polymer Opalweiß **VS**, transparent **TR**. Kann durch eine als Zubehör verkaufte Schablone auch halb eingebaut werden. Dimmbar mit entsprechendem Light Dimmer (nicht inbegriffen). Auch für Außenbereiche geeignet. Dimmbar mit separaten Dimmer (nicht im Lieferumfang enthalten).

A4262
Schablone für halbeinbau Montage Lochgröße für Wand und Decke 27x14,5 cm)

Lámpara de pared y plafón. Cuerpo de polímero plástico mate. Difusor de polímero plástico opalino **VS**, transparente **TR**. Puede instalarse semiempotrada gracias al escantillón disponible como accesorio. Emisión luminosa regulable con dimer (no suministrado). Idónea también para ambientes exteriores. Dimerable con un dimer remoto (no incluido).

A4262
Plantilla para la instalación semi-empotrada (tamaño del hueco en pared y plafón de 27x14,5 cm)

lampadine / bulbs / ampoules / Glühbirnen / bombillas



IP55

Classe II



INCL. LED

NOT REPLACEABLE

○ 13W LED LINE VOLTAGE (2700 K, CRI 80, 1150 Lm)

VOLÉE

pag. 296

Lampada da tavolo e parete / Table and wall lamp / Lampe de table et applique / Tischleuchte und Wandleuchte / Lámpara de sobremesa y pared

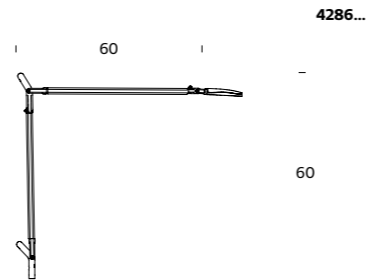

4286...

Apparecchio di illuminazione da tavolo e da parete a luce diretta e testa orientabile. Corpo in alluminio estruso, testa in alluminio pressofuso, giunti in alluminio pressofuso e funi meccaniche in acciaio. Disponibili base tavolo, morsetto, attacco a parete da unire al corpo, il tutto nei colori grigio chiaro **GC** (RAL 7044 opaco), grigio antracite **GS** (RAL 7024 opaco), bianco **BI** (RAL 9016 opaco) e giallo fluorescente **GI**. Un semplice movimento della mano sotto la testa dell'apparecchio attiva un dispositivo elettronico che consente di accendere e spegnere la lampada senza la necessità di toccarla (touchless). Un sensore a sfioramento posto sopra la testa dell'apparecchio consente la regolazione del flusso luminoso su quattro diversi livelli di intensità (0%, 40%, 60%, 100%). Un sistema Time Out spegne automaticamente la lampada dopo 5 ore di funzionamento. Una volta spenta, la lampada mantiene in memoria l'ultimo livello di intensità luminosa utilizzato. La lampada è fornita di presa multipla. Cavo di alimentazione, ballast su cavo e spina colore nero.

Table and wall lamp with direct light emission and adjustable head. Body in extruded aluminium, head in die-cast aluminium and mechanical wires in steel. Provided with base for table, clamp and wall mounting to be combined with the body, available light grey **GC** (RAL 7044 matt), anthracite grey **GS** (RAL 7024 matt), white **BI** (RAL 9016 matt) and fluorescent yellow **GI**. A simple wave of the hand under the head of the lamp activates an electronic device that switches the light on or off without any contact (touchless). A touch sensor over the head allows the flow of light to be regulated to four different levels of intensity (0%, 40%, 60%, 100%). A Time Out system automatically switches the lamp off after it has been on for 5 hours. Once the lamp is switched off, it keeps the last light intensity used. The lamp is supplied with multiple plug. Black power cable, ballast on cable and plug.

Applique et lampe de table avec émission de lumière directe et tête orientable. Corps en aluminium extrudé, tête et joints en aluminium moulés sous pression, et cordes mécaniques en acier. Disponibles avec base pour table, étai, attache pour applique à unir avec le corps, le tout en couleur gris clair **GC** (RAL 7044 mate), gris anthracite **GS**, blanc **BI** (RAL 9016 mate) et jaune fluorescent **GI** (RAL 1026 mate). Un simple mouvement de la main sous la tête de l'appareil active un dispositif électronique qui permet d'allumer et d'éteindre la lampe sans la nécessité de la toucher (touchless). Un capteur tactile posé sur la tête de l'appareil permet la régulation du flux lumineux avec 4 divers niveaux d'intensité (0%, 40%, 60%, 100%). Un système Time out éteint automatiquement la lampe après 5 heures de fonctionnement. Une fois éteinte, la lampe garde en mémoire le dernier niveau d'intensité de lumière utilisée. La lampe est livrée avec une fiche multiple. Câble d'alimentation, ballast sur câble et prise de couleur noire.

Tisch- und Wandleuchte mit direkter Lichtemission und justierbarem Lichtkopf. Struktur aus Strangpress-Aluminium, Verbindungsdetails und Lichtkopf aus Aluminium Druckguss, Zugseile aus Edelstahl. Ein Tischfuß eine Tischklemme oder eine Wandhalterung kann mit der Leuchte verbunden werden. Verfügbare in den seidenmatt lackierten Oberflächen: weissgrau **GC** (RAL 7044 matt), anthrazit **GS** (RAL 7024 matt), weiss **BI** (RAL 9016 matt) oder Neongelb **GI**. Eine einfache Handbewegung unter dem Lichtkopf aktiviert eine Elektronik die es ermöglicht die Leuchte berührungslos ein- und auszuschalten. Ein weiterer Sensor auf der Oberseite des Lichtkopfs ermöglicht die Helligkeitsregulierung in 4 Stufen (0%, 40%, 60%, 100%). Die integrierte Abschaltautomatik schaltet die Leuchte nach 5 Stunden aus. Eine einfache Handbewegung unter dem Lichtkopf reaktiviert die Leuchte auf der zuletzt eingestellten Helligkeitsstufe. Die schwarze Zuleitung ist mit einem Steckernetzgerät ausgestattet.

Lámpara de mesa y pared de luz directa y cabeza orientable. Cuerpo en aluminio extruido, cabeza y juntas en aluminio fundido, tensores en acero. Disponible con base de mesa, pinza o soporte de pared. Color gris claro **GC** (RAL 7044 mate), gris antracita **GS** (RAL 7024 mate), blanco **BI** (RAL 9016 mate) y amarillo fluorescente **GI**. Con un leve movimiento de la mano por debajo de la cabeza se activa un sensor que permite encender y apagar la lámpara sin necesidad de tocarla (touchless). Otro sensor táctil ubicado sobre la cabeza permite regular la intensidad de la luz según 4 niveles de intensidad (0%, 40%, 60%, 100%). Un sistema Time Out apaga automáticamente la lámpara después de 5 horas seguidas de uso. Una vez apagada, la lámpara memoriza el último nivel de intensidad. Se incluyen con la lámpara un enchufe universal, cable de alimentación y transformador de color negro.

lampadine / bulbs / ampoules / Glühbirnen / bombillas



IP20

Classe II



INCL. LED

NOT REPLACEABLE

○ LED - 7,5W (2700 K, CRI-90, 800 Lm)

Accessori / Accessories / Accessoires / Zubehör / Accesorios

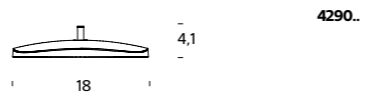

4290..

Base da tavolo

Table base

Base pour table

Tischfuß

Base para mesa



4288..

Morsetto

Clamp

Étau

Tischklemme

Pinza



4333

Attacco Fisso

Fixed clamp

Attache fixe

Fester Socket

Enganche fijo



4325..

Supporto a parete

Wall support

Support mural

Wandsocket

Soporte de pared

DEMI VOLÉE

pag. 298

Lampada da tavolo e parete / Table and wall lamp / Lampe de table et applique / Tischleuchte und Wandleuchte / Lámpara de sobremesa y pared

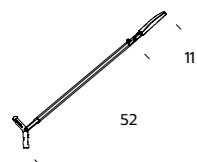

4289...

Apparecchio di illuminazione da tavolo e da parete a luce diretta e testa orientabile. Corpo in alluminio estruso, testa in alluminio pressofuso, giunti in alluminio pressofuso e funi meccaniche in acciaio. Disponibili base tavolo, morsetto, attacco a parete da unire al corpo, il tutto nei colori grigio chiaro **GC** (RAL 7044 opaco), grigio antracite **GS** (RAL 7024 opaco), bianco **BI** (RAL 9016 opaco) e giallo fluorescente **GI**. Un semplice movimento della mano sotto la testa dell'apparecchio attiva un dispositivo elettronico che consente di accendere e spegnere la lampada senza la necessità di toccarla (touchless). Un sensore a sfioramento posto sopra la testa dell'apparecchio consente la regolazione del flusso luminoso su quattro diversi livelli di intensità (0%, 40%, 60%, 100%). Un sistema Time Out spegne automaticamente la lampada dopo 5 ore di funzionamento. Una volta spenta, la lampada mantiene in memoria l'ultimo livello di intensità luminosa utilizzato. La lampada è fornita di presa multipla. Cavo di alimentazione, ballast su cavo e spina colore nero.

Table and wall lamp with direct light emission and adjustable head. Body in extruded aluminium, head in die-cast aluminium, joints in mechanical wires in steel. Provided with base for table, clamp and wall mounting to be combined with the body, available light grey **GC** (RAL 7044 matt), anthracite grey **GS** (RAL 7024 matt), white **BI** (RAL 9016 matt) and fluorescent yellow **GI**. A simple wave of the hand under the head of the lamp activates an electronic device that switches the light on or off without any contact (touchless). A touch sensor over the head allows the flow of light to be regulated to four different levels of intensity (0%, 40%, 60%, 100%). A Time Out system automatically switches the lamp off after it has been on for 5 hours. Once the lamp is switched off, it keeps the last light intensity used. The lamp is supplied with multiple plug. Black power cable, ballast on cable and plug.

Applique et lampe de table avec émission de lumière directe et tête orientable. Corps en aluminium extrudé, tête et joints en aluminium moulés sous pression, et cordes mécaniques en acier. Disponibles avec base pour table, étai, attache pour applique à unir avec le corps, le tout en couleur gris clair **GC** (RAL 7044 mate) gris anthracite **GS**, blanc **BI** (RAL 9016 mate) et jaune fluorescent **GI** (RAL 1026 mate). Un simple mouvement de la main sous la tête de l'appareil active un dispositif électronique qui permet d'allumer et d'éteindre la lampe sans la nécessité de la toucher (touchless). Un capteur tactile posé sur la tête de l'appareil permet la régulation du flux lumineux avec 4 divers niveau d'intensité (0%, 40%, 60%, 100%). Un système Time out éteint automatiquement la lampe après 5 heures de fonctionnement. Une fois éteinte, la lampe garde en mémoire le dernier niveau d'intensité de lumière utilisée. La lampe est livrée avec une fiche multiple. Câble d'alimentation, ballast sur câble et prise de couleur noire.

Tisch- und Wandleuchte mit direkter Lichtemission und justierbarem Lichtkopf. Struktur aus Strangpress-Aluminium, Verbindungsdetails und Lichtkopf aus Aluminium Druckguss, Zugseile aus Edelstahl. Ein Tischfuss eine Tischklemme oder eine Wandhalterung kann mit der Leuchte verbunden werden. Verfügbar in den seidenmatt lackierten Oberflächen: weissgrau **GC** (RAL 7044 matt), anthrazit **GS** (RAL 7024 matt), weiss **BI** (RAL 9016 matt) oder Neongelb **GI**. Eine einfache Handbewegung unter dem Lichtkopf aktiviert eine Elektronik die es ermöglicht die Leuchte berührungslos ein- und auszuschalten. Ein weiterer Sensor auf der Oberseite des Lichtkopfs ermöglicht die Helligkeitsregulierung in 4 Stufen (0%, 40%, 60%, 100%). Die integrierte Abschaltautomatik schaltet die Leuchte nach 5 Stunden aus. Eine einfache Handbewegung unter dem Lichtkopf reaktiviert die Leuchte auf der zuletzt eingestellten Helligkeitsstufe. Die schwarze Zuleitung ist mit einem Steckernetzgerät ausgestattet.

Lámpara de mesa y pared de luz directa y cabeza orientable. Cuerpo en aluminio extruido, cabeza y juntas en aluminio fundido, tensores en acero. Disponible con base de mesa, pinza o soporte de pared. Color gris claro **GC** (RAL 7044 mate), gris antracita **GS** (RAL 7024 mate), blanco **BI** (RAL 9016 mate) y amarillo fluorescente **GI**. Con un leve movimiento de la mano por debajo de la cabeza se activa un sensor que permite encender y apagar la lámpara sin necesidad de tocarla (touchless). Otro sensor táctil ubicado sobre la cabeza permite regular la intensidad de la luz según 4 niveles de intensidad (0%, 40%, 60%, 100%). Un sistema Time Out apaga automáticamente la lámpara después de 5 horas seguidas de uso. Una vez apagada, la lámpara memoriza el último nivel de intensidad. Se incluyen con la lámpara un enchufe universal, cable de alimentación y transformador de color negro.

lampadine / bulbs / ampoules / Glühbirnen / bombillas

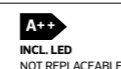

○ LED - 7,5W (2700 K, CRI>90, 800 Lm)

Accessori / Accessories / Accessoires / Zubehör / Accesorios

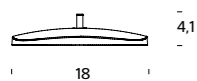

4290..

Base da tavolo

Table base

Base pour table

Tischfuss

Base para mesa

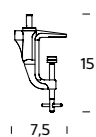

4288..

Morsetto

Clamp

Étau

Tischklemme

Pinza



4333

Attacco Fisso

Fixed clamp

Attache fixe

Fester Sockel

Enganche fijo

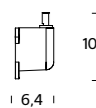

4325..

Supporto a parete

Wall support

Support mural

Wandsocket

Soporte de pared

WIG

pag. 300

Lampada a sospensione / Suspension lamp / Suspension / Pendelleuchte / Suspensión

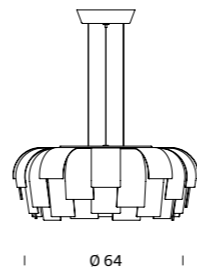

4182BI

Lampada a sospensione. Corpo diffusore costituito da una composizione di petali curvati in metallo verniciato bianco lucido (RAL 9003 lucido). Disco diffusore inferiore in metacrilato satinato. Cavi di sospensione in acciaio regolabili in altezza.

Suspension lamp. Diffuser composed of curved petals in white gloss finish metal (RAL 9003 gloss). Lower diffuser disc in frosted methacrylate. Height-adjustable steel suspension cables.

Suspension. Corps diffuseur constitué d'une composition de pétales recourbés en métal peint en blanc brillant (RAL 9003 brillante). Disque diffuseur inférieur en méthacrylate satiné. Câbles de suspension en acier réglables en hauteur.

Hängeleuchte. Der Diffusorkörper besteht aus gebogener Blütenblätter aus glänzend weiß lackiertem Metall (RAL 9003 glänzend). Untere Diffusorscheibe aus satiniertem Methacrylat. Höhenverstellbare Aufhängekabel aus Stahl.

Lámpara de techo. Cuerpo difusor formado por una composición de pétalos curvos de metal pintado blanco brillante (RAL 9003 brillante). Disco difusor inferior de metacrilato satinado. Cables de suspensión de acero regulables en altura.

lampadine / bulbs / ampoules / Glühbirnen / bombillas



● 3×70W (HA) Ⓜ E27 or

○ 3×20W (FL) E27

YUMI

pag. 302

Lampada da terra / Floor lamp / Lampadaire / Stehleuchte / Lámpara de pie

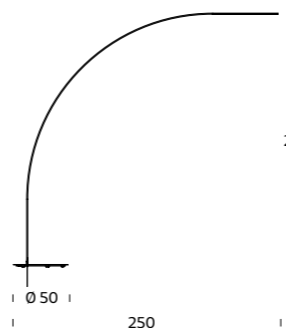

4143

Lampada da terra. Struttura in materiale composito rivestito in fibra di carbonio, colore nero. Base in metallo verniciata di colore nero. Cavi di alimentazione annegati nella struttura. Emissione di luce diretta.

Floor lamp. Structure in composite material coated with black carbon fibre. Black lacquered metal base. Power cables sunk into the structure. Direct light emission.

Lampadaire. Structure en matériau composite recouvert de fibre de carbone, de couleur noire. Base en métallique vernie noire. Câbles d'alimentation intégrés à la structure. Émission de lumière directe.

Stehleuchte. Struktur aus Verbundstoff, mit Kohlefaser verkleidet, schwarz. Basis aus Metall, schwarz lackiert. Zuleitung in der Struktur verborgen. Direkte Lichtabgabe.

Lámpara de pie. Estructura de material composite revestido de fibra de carbono, color negro. Base de metal pintada de color negro. Cables de alimentación en el interior de la estructura. Emisión de luz directa.

lampadine / bulbs / ampoules / Glühbirnen / bombillas



○ 170 LED - 18W (3000 K, CRI>85, 1105 Lm)

4143..

Lampada da terra. Struttura in alluminio. Base in metallo. Disponibile verniciata colore bianco **BI** (RAL 9016 opaco) e rosso **R** (RAL 3024 opaco). Cavi di alimentazione annegati nella struttura. Emissione di luce diretta.

Floor lamp. Structure in aluminum. Metal base. Available painted white **BI** (RAL 9016 matt) and red **R** (RAL 3024 matt). Power cables sunk into the structure. Direct light emission.

Lampadaire. Structure en aluminium. Base en métal. Disponible laqué blanc **BI** (RAL 9016 mate) et rouge **R** (RAL 3024 mate). Câbles d'alimentation intégrés à la structure. Émission de lumière directe.

Bodenleuchte. Struktur aus Aluminium. Metallbasis. Erhältlich lackiert weiß **BI** (RAL 9016 matt), und rot **R** (RAL 3024 matt). Zuleitung in der Struktur verborgen. Direkte Lichtabgabe.

Lámpara de pie. Estructura de aluminio. Base de metal. Disponible pintada color blanco **BI** (RAL 9016 mate), y rojo **R** (RAL 3024 mate). Cables de alimentación en el interior de la estructura. Emisión de luz directa.

lampadine / bulbs / ampoules / Glühbirnen / bombillas



○ 170 LED - 18W (3000 K, CRI>85, 1105 Lm)

YUPIK

pag. 306

Lampada da tavolo / Table lamp / Lampe de table / Tischleuchte / Lámpara de sobremesa

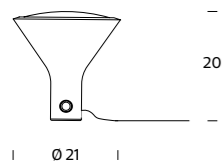

IT	EN	FR	DE	ES
<p>4256..</p> <p>Lampada portatile. Corpo in polipropilene espanso, disponibile grigio chiaro G e nero N. Diffusore in policarbonato trasparente. Dotata di cavo di alimentazione nero, lungo 5 metri, che consente alla lampada di essere spostata e posizionata su un piano con la fonte luminosa rivolta verso l'alto oppure appoggiata su un lato oppure anche appesa, tramite un gancio che permette di legare il cavo (disponibile come accessorio venduto separatamente).</p>	<p>Portable lamp. Body in polypropylene foam, available in pale grey G and black N. Diffuser in clear polycarbonate. Fitted with 5-metre black power cable, allowing the lamp to be moved and placed on a surface with the light source directed upwards, laid on one side or even hung up, thanks to a hook that can be used for holding the cable (available as an accessory, sold separately).</p>	<p>Lampe portable. Corps en polyéthylène expansé, disponible en gris clair G et noir N. Diffuseur en polycarbonate transparent. Le câble d'alimentation noir, de 5 mètres de long, permet de déplacer la lampe. Elle peut être posée avec sa source lumineuse orientée vers le haut, poséelatéralement ou encore suspendue grâce à un crochet permettant la fixation du câble (disponible comme accessoire, vendu séparément).</p>	<p>Tragbare Leuchte. Körper aus expandiertem Polypropylen, erhältlich in Hellgrau G und Schwarz N. Diffusor aus transparentem Polycarbonat. Ausgerüstet mit einem 5 m langen schwarzen Netzkabel, das es ermöglicht, die Leuchte zu bewegen und auf eine Oberfläche mit der Lichtquelle nach oben zu stellen oder zu einer Seite geneigt oder auch aufgehängt mittels Kabelschlaufe und Haken (als Zubehör erhältlich).</p>	<p>Lámpara portátil. Cuerpo de polipropileno expandido, disponible en gris claro G y negro N. Difusor de policarbonato transparente. Dotada de cable de alimentación negro de 5 metros de longitud, que permite desplazar la lámpara y colocarla sobre una superficie con la fuente de luz dirigida hacia arriba, apoyada sobre un lado o incluso colgada con un gancho para poder atar el cable (disponible como accesorio, que se vende por separado).</p>

lampadine / bulbs / ampoules / Glühbirnen / bombillas



1x14W (FL) E27



<p>A4256</p> <p>Gancio per montaggio a parete o sospensione</p>	<p>Hook for wall and suspension use</p>	<p>Support pour utilisation murale ou en suspension</p>	<p>Wand- und Deckenhaken liegt bei</p>	<p>Gancho para su uso en pared o colgado</p>
------------------------------------------------------------------------	-----------------------------------------	---------------------------------------------------------	----------------------------------------	----------------------------------------------

YVES

pag. 308

Lampada da parete / Wall lamp / Applique Wandleuchte / Applique

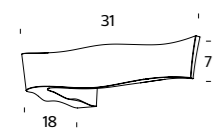

IT	EN	FR	DE	ES
<p>4049..</p> <p>Lampada da parete. Emissione di luce indiretta. Struttura in pressofusione di alluminio verniciata colore bianco BI (RAL 9003 lucido) oppure spazzolata NS. Protezione per lampadina alogena in vetro borosilicato sabbiato.</p>	<p>Wall lamp. Indirect beam. White-painted BI (RAL 9003 gloss) or brushed NS die-cast aluminium frame. Halogen bulb shield in sandblasted borosilicate glass.</p>	<p>Applique. Émission de lumière indirecte. Structure en aluminium moulé sous pression, peint en blanc BI (RAL 9003 brillante) ou brossé NS. Protection pour ampoule halogène en verre borosilicate sablé.</p>	<p>Wandleuchte. Indirekte Beleuchtung. Struktur aus weiß lackiertem BI (RAL 9003 glänzend) oder gebürstetem Aluminium-Druckguss NS. Schutzschirm für Halogenleuchtmittel aus sandgestrahltem Borosilikatglas.</p>	<p>Lámpara de pared. Emisión luminosa indirecta. Estructura de aluminio moldeado bajo presión, pintada en color blanco BI (RAL 9003 brillante) o cepillada NS. Protección para bombilla halógena de vidrio borosilicato arenado.</p>

lampadine / bulbs / ampoules / Glühbirnen / bombillas

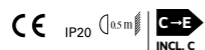

1x230W (HA) R7s/115



<p>A4049...</p> <p>Plattello 13x9</p>	<p>Plate 13x9</p>	<p>Plateau 13x9</p>	<p>Teller 13x9</p>	<p>Platillo 13x9</p>
----------------------------------------------	-------------------	---------------------	--------------------	----------------------

HOME TO LIVE

CARTOCCIO

pag. 346

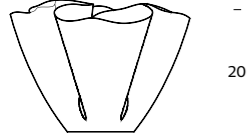
	IT	EN	FR	DE	ES
	2029... Vaso in vetro. Disponibile in vetro naturale bianco VN/BI e blu VN/BL , in vetro satinato naturale VS , satinato bianco VS/BI e blu VS/BL .	Glass vase. Available in natural glass either white VN/BI or blue VN/BL , in frosted glass either natural VS , or white VS/BI and blue VS/BL .	Vase en verre. Disponible en verre naturel blanc VN/BI ou bleu VN/BL , en verre satiné naturel VS , satiné blanc VS/BI ou bleu VS/BL .	Glasvase. Erhältlich aus Naturglas weiß VN/BI und blau VN/BL , aus satiniertem Naturglas VS , aus satiniertem Glas in Weiß VS/BI und Blau VS/BL .	Jarrón de vidrio. Disponible en vidrio natural blanco VN/BI y azul VN/BL , en vidrio satinado natural VS , satinado blanco VS/BI y azul VS/BL .

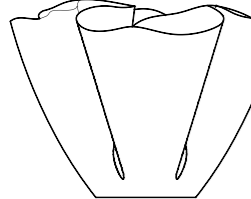
	2029/1... Vaso in vetro. Disponibile in vetro naturale bianco VN/BI e blu VN/BL , in vetro satinato naturale VS , satinato bianco VS/BI e blu VS/BL .	Glass vase. Available in natural glass either white VN/BI or blue VN/BL , in frosted glass either natural VS , or white VS/BI and blue VS/BL .	Vase en verre. Disponible en verre naturel blanc VN/BI ou bleu VN/BL , en verre satiné naturel VS , satiné blanc VS/BI ou bleu VS/BL .	Glasvase. Erhältlich aus Naturglas weiß VN/BI und blau VN/BL , aus satiniertem Naturglas VS , aus satiniertem Glas in Weiß VS/BI und Blau VS/BL .	Jarrón de vidrio. Disponible en vidrio natural blanco VN/BI y azul VN/BL , en vidrio satinado natural VS , satinado blanco VS/BI y azul VS/BL .
----------------------------------------------------------------------------------	----------------------------------------------------------------------------------------------------------------------------------------------------------------------------------------------------	-----------------------------------------------------------------------------------------------------------------------------------------------------------------------------------	---------------------------------------------------------------------------------------------------------------------------------------------------------------------------	--------------------------------------------------------------------------------------------------------------------------------------------------------------------------------------	------------------------------------------------------------------------------------------------------------------------------------------------------------------------------------

CARTOCCIO 2029Q

pag. 346

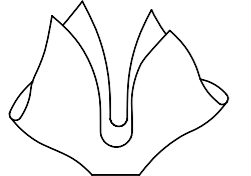
	IT	EN	FR	DE	ES
	2029Q Vaso in vetro trasparente.	Vase in transparent glass.	Vase en verre transparent.	Vase aus transparentem Glas.	Jarrón de vidrio transparente.

FONTANA

pag. 350

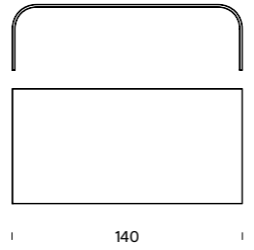
	IT	EN	FR	DE	ES
	2633 Tavolino in vetro float dello spessore di 15 mm, curvato e molato.	Coffee table in 15 mm curved cut float glass.	Table basse en verre flotté (épaisseur 15 mm), courbé et biseauté.	Kleiner Tisch aus gebogenem und geschliffenen Float-Glas (Dicke 15 mm).	Mesita de vidrio float de 15 mm de grosor, curvado y desbastado.

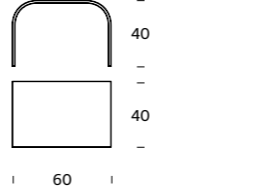
	2633/1 Tavolino in vetro float dello spessore di 15 mm, curvato e molato.	Coffee table in 15 mm curved cut float glass.	Table basse en verre flotté (épaisseur 15 mm), courbé et biseauté.	Kleiner Tisch aus gebogenem und geschliffenen Float-Glas (Dicke 15 mm).	Mesita de vidrio float de 15 mm de grosor, curvado y desbastado.
-------------------------------------------------------------------------------------	-------------------------------------------------------------------------------------	-----------------------------------------------	--------------------------------------------------------------------	-------------------------------------------------------------------------	------------------------------------------------------------------

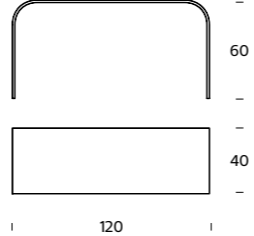
	2633/2 Tavolino in vetro float dello spessore di 15 mm, curvato e molato.	Coffee table in 15 mm curved cut float glass.	Table basse en verre flotté (épaisseur 15 mm), courbé et biseauté.	Kleiner Tisch aus gebogenem und geschliffenen Float-Glas (Dicke 15 mm).	Mesita de vidrio float de 15 mm de grosor, curvado y desbastado.
--------------------------------------------------------------------------------------	-------------------------------------------------------------------------------------	-----------------------------------------------	--------------------------------------------------------------------	-------------------------------------------------------------------------	------------------------------------------------------------------

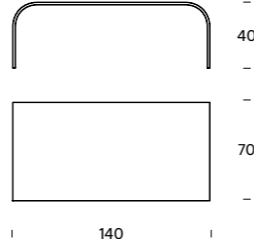
	2633/4 Tavolino in vetro float dello spessore di 15 mm, curvato e molato.	Coffee table in 15 mm curved cut float glass.	Table basse en verre flotté (épaisseur 15 mm), courbé et biseauté.	Kleiner Tisch aus gebogenem und geschliffenen Float-Glas (Dicke 15 mm).	Mesita de vidrio float de 15 mm de grosor, curvado y desbastado.
---------------------------------------------------------------------------------------	-------------------------------------------------------------------------------------	-----------------------------------------------	--------------------------------------------------------------------	-------------------------------------------------------------------------	------------------------------------------------------------------

TAVOLINO 1932

pag. 352

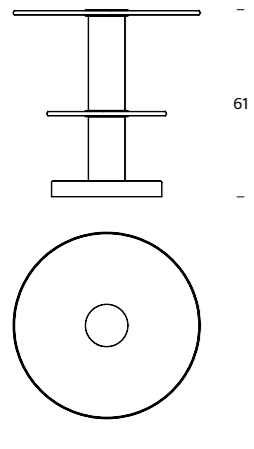
IT	EN	FR	DE	ES	
 <p>2747</p>	<p>Tavolino con due dischi in vetro float dello spessore di 15 mm. Struttura in ottone nichelato e spazzolato.</p>	<p>Coffee table made from two 15 mm discs of float glass. Frame in polished nickel-plated metal.</p>	<p>Table basse avec deux disques en verre flotté, épaisseur 15 mm. Structure en métal nickelé et brossé.</p>	<p>Kleiner Tisch mit zwei runden Float-Glasplatten mit 15 mm Dicke. Struktur aus vernickeltem und gebürstetem Metall.</p>	<p>Mesita con dos discos de vidrio float de 15 mm de grosor. Estructura de metal niquelado y cepillado.</p>

TAVOLO CON RUOTE

pag. 354

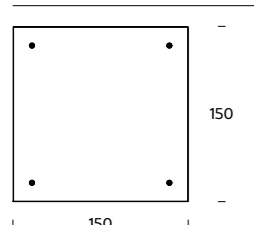
IT	EN	FR	DE	ES	
 <p>2652</p>	<p>Tavolino. Piano in vetro float molato (dello spessore di 15 mm). Ruote industriali con forcelle in metallo verniciato nero ottico.</p>	<p>Coffee table. 15 mm cut float-glass top. Industrial wheels with metal forks in optical black finish.</p>	<p>Table basse. Plateau en verre flotté biseauté (épaisseur 15 mm). Roulettes industrielles avec fourches en métal peint en noir optique.</p>	<p>Kleiner Tisch. Oberfläche aus geschliffenem Float- Glas (Dicke 15 mm). Industrieräder mit Gabeln aus schwarz lackiertem optischen Metall.</p>	<p>Mesita. Sobre de vidrio float desbastado de 15 mm de grosor. Ruedas industriales con horquillas de metal pintado negro óptico.</p>
 <p>2653</p>	<p>Tavolino. Piano in vetro float molato (dello spessore di 15 mm). Ruote industriali con forcelle in metallo verniciato nero ottico.</p>	<p>Coffee table. 15 mm cut float-glass top. Industrial wheels with metal forks in optical black finish.</p>	<p>Table basse. Plateau en verre flotté biseauté (épaisseur 15 mm). Roulettes industrielles avec fourches en métal peint en noir optique.</p>	<p>Kleiner Tisch. Oberfläche aus geschliffenem Float- Glas (Dicke 15 mm). Industrieräder mit Gabeln aus schwarz lackiertem optischen Metall.</p>	<p>Mesita. Sobre de vidrio float desbastado de 15 mm de grosor. Ruedas industriales con horquillas de metal pintado negro óptico.</p>
 <p>2744</p>	<p>Tavolino. Piano in vetro float molato (dello spessore di 15 mm). Ruote industriali con forcelle in metallo verniciato nero ottico.</p>	<p>Coffee table. 15 mm cut float-glass top. Industrial wheels with metal forks in optical black finish.</p>	<p>Table basse. Plateau en verre flotté biseauté (épaisseur 15 mm). Roulettes industrielles avec fourches en métal peint en noir optique.</p>	<p>Kleiner Tisch. Oberfläche aus geschliffenem Float- Glas (Dicke 15 mm). Industrieräder mit Gabeln aus schwarz lackiertem optischen Metall.</p>	<p>Mesita. Sobre de vidrio float desbastado de 15 mm de grosor. Ruedas industriales con horquillas de metal pintado negro óptico.</p>
 <p>2745</p>	<p>Tavolino. Piano in vetro float molato (dello spessore di 15 mm). Ruote industriali con forcelle in metallo verniciato nero ottico.</p>	<p>Coffee table. 15 mm cut float-glass top. Industrial wheels with metal forks in optical black finish.</p>	<p>Table basse. Plateau en verre flotté biseauté (épaisseur 15 mm). Roulettes industrielles avec fourches en métal peint en noir optique.</p>	<p>Kleiner Tisch. Oberfläche aus geschliffenem Float- Glas (Dicke 15 mm). Industrieräder mit Gabeln aus schwarz lackiertem optischen Metall.</p>	<p>Mesita. Sobre de vidrio float desbastado de 15 mm de grosor. Ruedas industriales con horquillas de metal pintado negro óptico.</p>

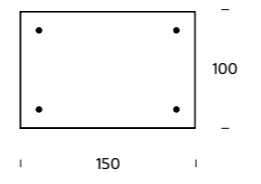
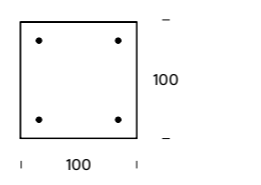
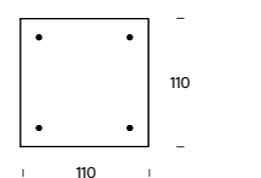
IT	EN	FR	DE	ES	
 <p>2746</p>	<p>Tavolino. Piano in vetro float molato (dello spessore di 15 mm). Ruote industriali con forcelle in metallo verniciato nero ottico.</p>	<p>Coffee table. 15 mm cut float-glass top. Industrial wheels with metal forks in optical black finish.</p>	<p>Table basse. Plateau en verre flotté biseauté (épaisseur 15 mm). Roulettes industrielles avec fourches en métal peint en noir optique.</p>	<p>Kleiner Tisch. Oberfläche aus geschliffenem Float- Glas (Dicke 15 mm). Industrieräder mit Gabeln aus schwarz lackiertem optischen Metall.</p>	<p>Mesita. Sobre de vidrio float desbastado de 15 mm de grosor. Ruedas industriales con horquillas de metal pintado negro óptico.</p>
 <p>2744/54</p>	<p>Tavolino. Piano in vetro float molato (dello spessore di 15 mm). Ruote industriali con forcelle in metallo verniciato nero ottico.</p>	<p>Coffee table. 15 mm cut float-glass top. Industrial wheels with metal forks in optical black finish.</p>	<p>Table basse. Plateau en verre flotté biseauté (épaisseur 15 mm). Roulettes industrielles avec fourches en métal peint en noir optique.</p>	<p>Kleiner Tisch. Oberfläche aus geschliffenem Float- Glas (Dicke 15 mm). Industrieräder mit Gabeln aus schwarz lackiertem optischen Metall.</p>	<p>Mesita. Sobre de vidrio float desbastado de 15 mm de grosor. Ruedas industriales con horquillas de metal pintado negro óptico.</p>
 <p>2744/55</p>	<p>Tavolino. Piano in vetro float molato (dello spessore di 15 mm). Ruote industriali con forcelle in metallo verniciato nero ottico.</p>	<p>Coffee table. 15 mm cut float-glass top. Industrial wheels with metal forks in optical black finish.</p>	<p>Table basse. Plateau en verre flotté biseauté (épaisseur 15 mm). Roulettes industrielles avec fourches en métal peint en noir optique.</p>	<p>Kleiner Tisch. Oberfläche aus geschliffenem Float- Glas (Dicke 15 mm). Industrieräder mit Gabeln aus schwarz lackiertem optischen Metall.</p>	<p>Mesita. Sobre de vidrio float desbastado de 15 mm de grosor. Ruedas industriales con horquillas de metal pintado negro óptico.</p>

TESO COLLECTION

pag. 356

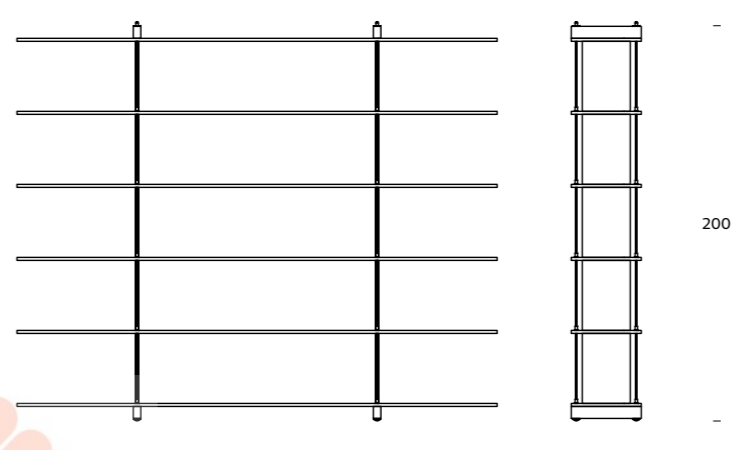
IT	EN	FR	DE	ES	
 <p>2757/6</p>	<p>Libreria aperta sui due lati. Ripiani e montanti in vetro float dello spessore rispettivamente di 15 mm e 25 mm. Tiranti in metallo cromato. La tensione, grazie all'elevato coefficiente di compressione del vetro, trasforma la libreria in un monoblocco.</p>	<p>Bookcase open on both sides. 15 mm shelves and 25 mm uprights in float glass. Chromed metal tie rods. Thanks to the high glass compression coefficient, the tension achieves a monobloc effect.</p>	<p>Bibliothèque ouverte sur les deux côtés. Étagères (épaisseur 15 mm) et montants (épaisseur 25 mm) en verre flotté. Tirants en métal chromé. Grâce au coefficient de compression élevé du verre, la tension transforme l'ensemble en un monobloc.</p>	<p>Auf beiden Seiten offenes Bücherregal. Fächer und Pfosten aus Float-Glas von 15 mm bzw. 25 mm Dicke. Spannstangen aus verchromtem Metall. Die Spannung verwandelt das Bücherregal durch den hohen Kompressionskoeffizienten in einen einzigen Glasblock.</p>	<p>Estantería abierta en los dos lados. Estantes y montantes de vidrio float de 15 mm y 25 mm de grosor respectivamente. Tirantes de metal cromado. Gracias al alto coeficiente de compresión del vidrio, la tensión transforma la librería en un bloque único.</p>

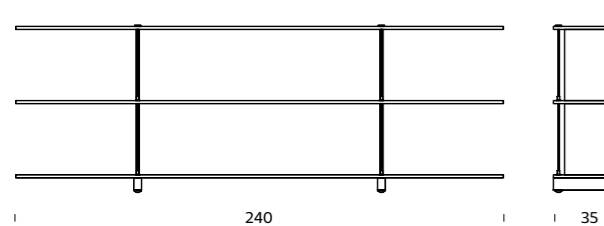
IT	EN	FR	DE	ES
<p>2842</p> <p>Consolle aperta sui due lati. Ripiani e montanti in vetro float dello spessore rispettivamente di 15 mm e 25 mm. Tiranti in metallo cromato. La tensione, grazie all'elevato coefficiente di compressione del vetro, trasforma la consolle in un monoblocco.</p> 	<p>Console open on both sides. 15 mm shelves and 25 mm uprights in float glass. Chromed metal tie rods. Thanks to the high glass compression coefficient, the tension achieves a monobloc effect.</p>	<p>Console ouverte sur les deux côtés. Etagères (épaisseur 15 mm) et montants (épaisseur 25 mm) en verre flotté. Tirants en métal chromé. Grâce au coefficient de compression élevé du verre, la tension transforme l'ensemble en un monobloc.</p>	<p>Auf beiden Seiten offene Konsole. Fächer und Pfosten aus Float-Glas mit Dicke 15 mm bzw. 25 mm. Spannstrangen aus verchromten Metall. Die Spannung verwandelt die Konsole durch den hohen Kompressionskoeffizienten in einen einzigen Glasblock.</p>	<p>Consola abierta en los dos lados. Estantes y montantes de vidrio float de 15 mm y 25 mm de grosor respectivamente. Tirantes de metal cromado. Gracias al alto coeficiente de compresión del vidrio, la tensión transforma la consola en un bloque único.</p>

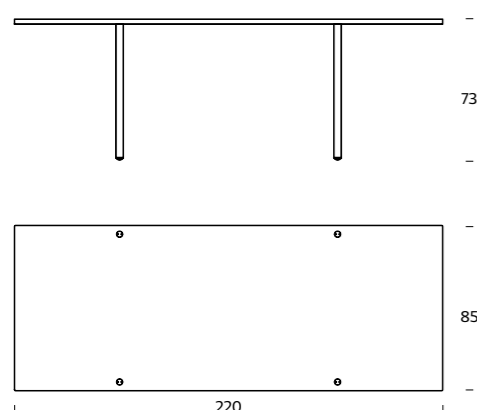
<p>2736/1</p> <p>Tavolo. Piano in vetro float stratificato (spessore 25 mm). Gambe in lastre di vetro float stratificato, dello spessore di 38 mm, con scanalature per inserimento di tiranti in metallo. La tensione, grazie all'elevato coefficiente di compressione del vetro, trasforma il tavolo in un monoblocco.</p> 	<p>Table with 25 mm laminated float-glass top and 38 mm laminated float-glass legs, fluted to house metal tie rods. Thanks to the high glass compression coefficient, the tension achieves a monobloc effect.</p>	<p>Table. Plateau en verre flotté stratifié (épaisseur 25 mm). Pieds en plaque de verre flotté stratifié (épaisseur 38 mm) rainurés pour l'introduction de tirants en métal. Grâce au coefficient de compression élevé du verre, la tension transforme la table en un monobloc.</p>	<p>Tisch. Oberfläche aus geschichtetem Float-Glas, (Dicke 25 mm). Tischbeine aus geschichteten Float-Glasplatten, mit Dicke 38 mm, mit Nuten zum Montieren der Spannstrangen aus Metall. Die Spannung verwandelt den Tisch durch den hohen Kompressionskoeffizienten in einen einzigen großen Block.</p>	<p>Mesa. Sobre de vidrio float laminado (grosor 25 mm). Patas de placas de vidrio float laminado de 38 mm de grosor, con ranuras para introducir tirantes de metal. Gracias al alto coeficiente de compresión del vidrio, la tensión transforma la mesa en un bloque único.</p>
----------------------------------------------------------------------------------------------------------------------------------------------------------------------------------------------------------------------------------------------------------------------------------------------------------------------------------------------------------------------------------------------------------------------	-------------------------------------------------------------------------------------------------------------------------------------------------------------------------------------------------------------------	-------------------------------------------------------------------------------------------------------------------------------------------------------------------------------------------------------------------------------------------------------------------------------------	----------------------------------------------------------------------------------------------------------------------------------------------------------------------------------------------------------------------------------------------------------------------------------------------------------	---------------------------------------------------------------------------------------------------------------------------------------------------------------------------------------------------------------------------------------------------------------------------------

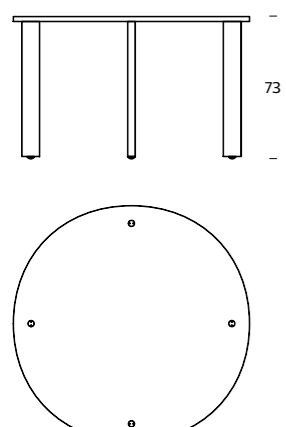
<p>2736/13</p> <p>Tavolo. Piano in vetro float stratificato (spessore 25 mm). Gambe in lastre di vetro float stratificato, dello spessore di 38 mm, con scanalature per inserimento di tiranti in metallo. La tensione, grazie all'elevato coefficiente di compressione del vetro, trasforma il tavolo in un monoblocco.</p> 	<p>Table with 25 mm laminated float-glass top and 38 mm laminated float-glass legs, fluted to house metal tie rods. Thanks to the high glass compression coefficient, the tension achieves a monobloc effect.</p>	<p>Table. Plateau en verre flotté stratifié (épaisseur 25 mm). Pieds en plaque de verre flotté stratifié (épaisseur 38 mm) rainurés pour l'introduction de tirants en métal. Grâce au coefficient de compression élevé du verre, la tension transforme la table en un monobloc.</p>	<p>Tisch. Oberfläche aus geschichtetem Float-Glas, (Dicke 25 mm). Tischbeine aus geschichteten Float-Glasplatten, mit Dicke 38 mm, mit Nuten zum Montieren der Spannstrangen aus Metall. Die Spannung verwandelt den Tisch durch den hohen Kompressionskoeffizienten in einen einzigen großen Block.</p>	<p>Mesa. Sobre de vidrio float laminado (grosor 25 mm). Patas de placas de vidrio float laminado de 38 mm de grosor, con ranuras para introducir tirantes de metal. Gracias al alto coeficiente de compresión del vidrio, la tensión transforma la mesa en un bloque único.</p>
------------------------------------------------------------------------------------------------------------------------------------------------------------------------------------------------------------------------------------------------------------------------------------------------------------------------------------------------------------------------------------------------------------------------	-------------------------------------------------------------------------------------------------------------------------------------------------------------------------------------------------------------------	-------------------------------------------------------------------------------------------------------------------------------------------------------------------------------------------------------------------------------------------------------------------------------------	----------------------------------------------------------------------------------------------------------------------------------------------------------------------------------------------------------------------------------------------------------------------------------------------------------	---------------------------------------------------------------------------------------------------------------------------------------------------------------------------------------------------------------------------------------------------------------------------------

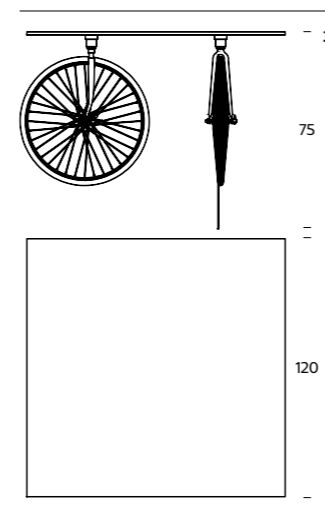
IT	EN	FR	DE	ES
<p>3005</p> <p>Tavolo. Piano in vetro float molato (spessore 15 mm). Ruote pivotanti fissate al piano mediante quattro piattelli in acciaio inox. Forcelle cromate. Copertoni in gomma piena.</p> 	<p>Table with 15 mm cut float glass top. Pivoting wheels are attached to the top by four stainless steel plates. Chromed forks. Solid rubber wheels.</p>	<p>Table. Plateau en verre flotté biseauté, (épaisseur 15 mm). Roues pivotantes fixées au plateau par quatre rondelles en acier inox. Fourches chromées. Pneumatiques en caoutchouc plein.</p>	<p>Tisch. Oberfläche aus geschliffenem Float-Glas (Dicke 15 mm). Frei drehende Räder, die mit vier Edelstahlscheiben an der Tischfläche befestigt sind. Verchromte Gabeln. Reifenmätel aus Vollgummi.</p>	<p>Mesa. Sobre de vidrio float desbastado (grosor 15 mm). Ruedas pivotantes fijadas en el sobre con cuatro patillos de acero inoxidable. Horquillas cromadas. Cubiertas de goma maciza.</p>

FontanaArte

a company of **TheNiceGroup**

Art Direction

Lorenzo Butti

Photography

Maurizio Cavallasca

Photo Credits

Jenna Bascom (pag. 83)
Pedro Lobo (pag. 84/85)
Giusy Pelleriti (pag. 321)
Thomas Schauer (pag. 75/76/77)

© FontanaArte 2016

Thanks to

Alias
Arflex
Baxter
B&B Italia
Aurel Basedov
Bolon
Bosco Verticale (Milan)
Simona Cardinetti
Catania Calcio (Catania)
Ceccotti Collezioni
De Padova
Desalto
Draga Obradovic
Flexform
Flou
Fritz Hansen
I+I
Imatex
Ittala
Kasthall
Kristina Lassus
Kussmaul (Vienna)
Lema
Living Divani
Meridiani
Misuraemme
Molteni&C
Piccolo Teatro (Milano)
Pinacoteca di Brera (Milano)
Poliform
Porro
Rattiflora
Rimadesio
Roda
Sambonet
Society Limonta
Tutto il Giorno (New York)
Università Bocconi (Milano)
Zanotta

HEADQUARTERS

FONTANAARTE SPA
Alzaia Trieste 49
20094 Corsico (MI)
Ph. +39 02 45121
Fax +39 02 4512660
info@fontanaarte.com

FLAGSHIP STORES

MILAN

Corso Monforte, 13
20122 Milano (MI)
Ph. +39 02 87213872
Fax +39 02 87213873
showroom-milano@fontanaarte.com

LONDON

Rosebery Avenue 7/15
EC1R 4SP London, UK
Ph. +44 (0) 20 33283560
info@fontanaarte.com

NEW YORK

45 Greene Street
New York, NY 10013, USA
Ph. +1 (212) 3343295
Fax +1 (212) 3341055
showroomny@fontanaarte.com

SUBSIDIARIES

FONTANAARTE FRANCE

1390 Avenue du Campon
06110 Le Cannet
Ph. +33 (0) 4 93 45 69 78
Fax +33 (0) 4 93 45 69 39
infofrance@fontanaarte.com

FONTANAARTE CORP.

45 Greene Street
New York, NY 10013, USA
Ph. +1 (212) 3343295
Fax +1 (212) 3341055
infousa@fontanaarte.com

FONTANAARTE UK

Automation House
Hamilton Road
NG17 5LD, Sutton in Ashfield
Nottinghamshire
Ph. +44 (0) 1623 444770
Fax +44 (0) 1623 550549
orderuk@fontanaarte.com

fontanaarte.com



1998

ADI Compasso d'Oro
Career Award

FontanaArte è azienda certificata ISO 9001:2008 con BSI (British Standard Institution). Certificato nr. FM 53033
FontanaArte has ISO 9001:2008 certification from the BSI (British Standards Institution). Certificate no. FMS3033
FontanaArte est une entreprise certifiée ISO 9001:2008 par la BSI (British Standards Institution). Certificat n° FM 53033.
FontanaArte ist ein nach ISO 9001:2008 mit der BSI (British Standards Institution) zertifiziertes Unternehmen. Zertifikat Nr. FM 53033
FontanaArte es una empresa certificada según la norma ISO 9001:2008 con BSI (British Standards Institution). Certificado n.º FM 53033