

almerich
A N E W L I G H T



2018



We want to show you a new light.



A new way of doing things is surfacing in our society and everything around us. Work, tradition and the value of well done things. Knowing how to transmit it and live it. That's what drives us. Because we don't want just to sell a product, but spreading a new way of seeing life. We want to show you a new light.

Una nueva forma de hacer las cosas está inundando nuestra sociedad y todo lo que nos rodea. El trabajo, la tradición, el valor de las cosas bien hechas. Saber transmitirlo y vivirlo. Eso es lo que nos mueve. Porque no queremos vender un producto, sino transmitir una nueva forma de ver la vida. Queremos enseñarte una nueva luz.

When in 1943 Antonio Almerich Villanueva founded the company with very modest means, he could not suspect how his project would be developed. His fighting spirit allowed him to delude us and today we form a modern company, referring in the sector of the lighting world-wide by our design and quality. Almerich has been able to evolve without losing its roots.

We know that having 75 years of history is a commitment and we firmly believe that maintaining the renewing spirit that characterizes us brings us a guarantee for the future. In each of our departments live young people, dynamic and source of new ideas with professionals who have spent decades in Almerich and who know their craft to perfection. They have been able to convey to the contemporary designs the best of our long experience in classic.

Now Almerich reinvents itself merging its best tradition with the most actual contemporaneity, searching for sophistication based on craftsmanship, innovation and culture of design. Timeless and sensitivity are mixed now with it's maximum exigency. A new phase of hope, passion and emotion to rediscover and nd ourselves. Image, concept, product and history. A new story. A new light.

Cuando en 1943 Antonio Almerich Villanueva fundó la empresa con medios muy modestos, no podía sospechar cómo ni por dónde se desarrollaría su proyecto. Su espíritu luchador le permitió ilusionar a los que recogimos su testigo y conformamos hoy una empresa moderna, referente en el sector de la iluminación a nivel mundial por nuestro diseño y calidad. Almerich ha sabido evolucionar sin perder sus raíces.

Sabemos que tener 75 años de historia es un compromiso y creemos firmemente que manteniendo el espíritu renovador que nos caracteriza tenemos una garantía de futuro. En cada uno de nuestros departamentos convive gente joven, dinámica y fuente de nuevas ideas con profesionales que llevan décadas en Almerich y que conocen a la perfección su oficio. Ellos han sido capaces de transmitir a los diseños contemporáneos lo mejor de nuestra larga experiencia en clásico.

Ahora, Almerich se reinventa fusionando su mejor tradición con la más actual contemporaneidad, buscando una sofisticación basada en la artesanía, la innovación y la cultura del diseño. Atemporalidad y sensibilidad se conjugan ahora con la mayor de las exigencias.

Una nueva etapa de ilusión, pasión y emoción.

Para redescubrir y redescubrirnos. Imagen, concepto, producto e historia.

Una nueva historia. A new light.



31
Boomerang



77
Blow



77
Blow



75
Blow



74
Blow



83
Cone

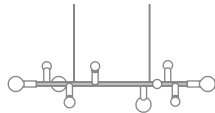

46
Party



44
Party



42
Party

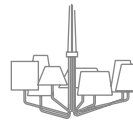

49
Tria



48
Tria

Hanging Lamps
Colgantes

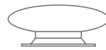

80
Blow



86
Cap



82
Cone



16
Coco



NEW!
22
Coco Small

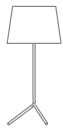

58
Minima

Table Lamps
Sobremesas



30
Boomerang



85
Cone



61
Minima



60
Minima



52
Tria



36
Monsieur

Floor Lamps
Lámparas de pie



78
Blow



78
Mini Blow



64
Giro



72
Maya



88
Pensilis



51
Tria

Wall Lamps
Apiques



78
Blow



78
Mini Blow

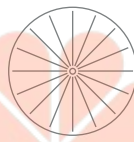

34
Raining day

Ceiling Lamps
Plafones



90
Hoffmann



70
Maya



73
Maya



73
Maya

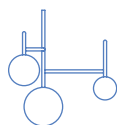

NEW!
15
Moon

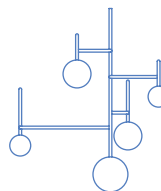

NEW!
15
Moon



41
Rem



62
Minima



63
Minima



NEW!
12
Moon



54
Self

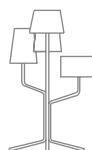

50
Tria

NEW!



10
Moon

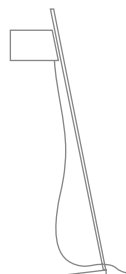

68
Próxima

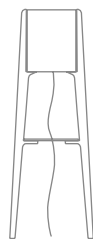

26
Tower

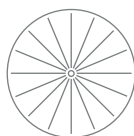

34
Raining day

COLLECTION

MOON

Based on the astral inspiration that illuminates the space recalling the nights of full moon. Its minimalist design and the combination of its geometric forms make it have a strong character and a balanced disorder.

Bebe de la inspiración astral que ilumina el espacio recordando las noches de luna llena. Su diseño minimalista y la combinación de sus formas geométricas hacen que tenga un carácter fuerte y un desorden equilibrado.

BY AGUSKIM STUDIO
REF 62034 ENGLISH GREEN





▲ REF 61063 GOLD

REF 61063 CHROME ▶



LUSTROGRAD
ОПТОВЫЕ ПРОДАЖИ СВЕТИЛЬНИКОВ





▲ REF 62034 SOFT GREEN

REF 60089 SOFT GREEN ▶



Balanced disorder.
Desorden equilibrado.

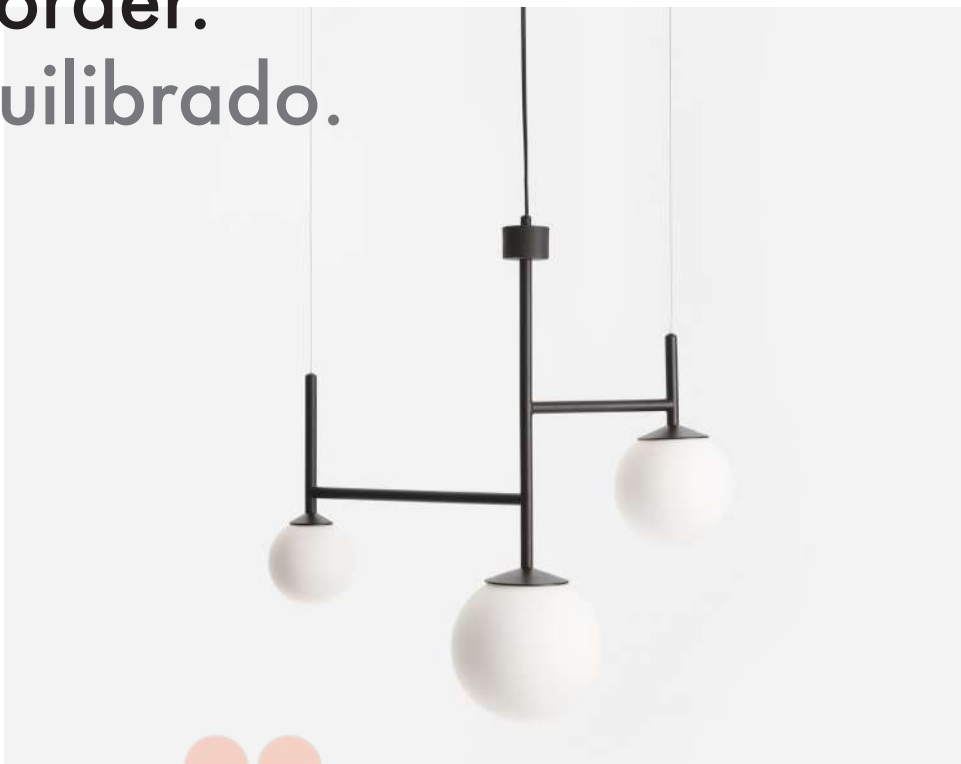

REF 60088 BLACK ▶

COCO

Characterized by contrasts; the rotundity of its geometry, the strength of the sphere opposed to the light structure and the warmth of the light. Its dome can be slightly directed in order to direct the light.

Caracterizada por los contrastes; la rotundidad de su geometría, la fuerza de la esfera contrapuesta a la ligereza visual de la estructura y la calidez de su luz. Su cúpula puede orientarse levemente con el fin de dirigir la luz.



BY ARNAU REYNA
REF 61060 CHROME







LUSTROGRAD
ОПТОВЫЕ ПРОДАЖИ СВЕТИЛЬНИКОВ

REF 61060 GOLD





Love for small details.
El amor por los pequeños detalles.



REF 61060B BLACK

LUSTROGRAD
ОПТОВЫЕ ПРОДАЖИ СВЕТИЛЬНИКОВ



COCO small

Retains the same proportions and materials on a smaller scale, making it possible to incorporate it in reduced surfaces, shelves and auxiliary tables. The warmth of its light and the movement of its dome are maintained as a sign of identity.

Conserva las mismas proporciones y materiales en una escala menor, posibilitando incorporarla en superficies reducidas, estanterías y mesas auxiliares. La calidez de su luz y el movimiento de su cúpula se mantienen como seña de identidad.

BY ARNAU REYNA
REF 61061B WHITE





REF 61061 FUME · 61061B WHITE



TOWER

Inspired in the old deposits of water, its tripod-shaped structure has a great sculptural character as well as total functionality, thanks to the addition of an auxiliary tray as a support table.

Inspirado en los antiguos depósitos de agua, su estructura en forma de trípode tiene un gran carácter escultórico además de una funcionalidad total, gracias a la incorporación de una bandeja auxiliar como mesa de apoyo.

BY HUGO TEJADA
REF 62029 BLACK











BOOMERANG

Inspired on the sequence of images of a boomerang in movement, this light shows this dynamism through a repetition of triangular sections piled together.

Inspirado en la secuencia de imágenes de un boomerang en movimiento, capta la belleza de este dinamismo a través de la repetición de una sección triangular.

BY LUIS ESLAVA

◀ FLOOR LAMP REF 62023 WHITE

PENDANT REF 60052 SLATE BLUE ▶







RAINING DAY

Created like a wall installation of oriental umbrellas. This sculptural piece transforms light like a leaden sky and nostalgic filter, like a raining day in Kyoto.

Creada como una instalación mural de sombrillas orientales. Esta pieza escultórica transforma la luz como un filtro plomizo y nostálgico, como un día de lluvia en Kyoto.

BY MERMELADA ESTUDIO
REF 64019 - 64020 - 64021 WHITE



MONSIEUR

Lightweight, stable and can be placed in virtually any space. It has a small support surface adjustable in height and its rotation system allows to adapt the direction of light.

Ligera, estable y puede ser colocada en prácticamente cualquier espacio. Dispone de una pequeña superficie de apoyo regulable en altura y su sistema de rotación permite adaptar la dirección de la luz.

BY THE EMOTION LAB
REF 62026 SOFT GREEN



**Timeless and
sensitivity.**



REF 62026 FOG BLUE - SOFT GREEN

LUSTROGRAD

ЖИВІ ПРОДАЖИ СВЕТИЛЬНИКІВ







REM

A very versatile and simple piece, which offers a game of direct and suggestive light perfect for any space.

De gran versatilidad y sencillez. Ofrece un juego de luz indirecta y sugerente perfecta para todo tipo de espacios.

BY YONOH
REF 60050 - 60051 WHITE

◀ REF 60050 SOFT GREEN

PARTY

Inspired in the garlands of bulbs of popular festivities, party transports us with nostalgia and moves this emotions to the interior design of spaces.

Inspirada por las guirnaldas de bombillas de las fiestas populares, Party nos transporta la nostalgia y traslada esas emociones al interior de los espacios.

BY ESTUDIO SAVAGE
REF 60081 CHROME





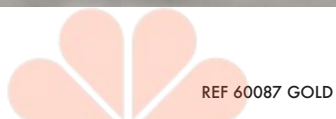

LUSTROGRAD
ОПТОВЫЕ ПРОДАЖИ СВЕТИЛЬНИКОВ



A new way of doing things



REF 60086 CHROME

LUSTROGRAD
ОПТОВЫЕ ПРОДАЖИ СВЕТИЛЬНИКОВ



TRIA Collection



Tria revitalises the archetype of classic chandelier with a configuration of four shades each with a unique geometry and dimension. It is characterized by its strong personality and its absolute contemporary look with a classic touch.

Tria revitaliza el arquetipo de lámpara clásica con una configuración de 4 pantallas de diferentes geometrías y tamaños. Caracterizada por su fuerte personalidad y su aspecto totalmente contemporáneo con cierto sabor clásico.

BY LUIS ESLAVA

REF 60071B CORAL PINK

63021 WHITE



▲ REF 61050B FOG BLUE

REF 63021B SLATE BLUE ▶





REF 62025B SLATE BLUE





SELF

With its twisting base and cap shade, Self aims to create a visual play, as the structure and shade have feedback and become a single piece.

De base zigzagueante y pantalla en forma de caperuza, Self busca crear un juego visual por el cual toda la lámpara, tanto su estructura como la pantalla, son una sola pieza.

BY LUIS ESLAVA
REF 61044 QUARTZ PINK





Honesty and authenticity.





MINIMA

It is the minimum expression, pure essence dispossessed of all ornaments. Its monomateriality in metallic finishes, the extreme simplicity of its forms and pure lines are the most personal characteristic.

Es la mínima expresión, despojada de todo elemento sobrante. Su monomaterialidad en acabados metálicos, la simplicidad de sus formas y líneas puras son su rasgo más personal.

BY ARNAU REYNA

◀ TABLE LAMP REF 61057 GOLD

FLOOR LAMP 62032 GOLD ▶

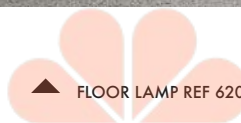

FLOOR LAMP REF 62033 BLACK

FLOOR LAMP 62032 SOFT GREEN



LUSTROGRAD
ОПТОВЫЕ ПРОДАЖИ СВЕТИЛЬНИКОВ



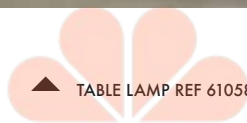

▲ TABLE LAMP REF 61058 CORAL PINK

TABLE LAMP 61059 WHITE ►

LUSTROGRAD
ОПТОВЫЕ ПРОДАЖИ СВЕТИЛЬНИКОВ



Tradition and contemporanity.



GIRO

Simple, discreet, elegant and sophisticated. Thanks to its studied way of turning, we can direct the light to almost any direction.

Sencillo, discreto, elegante y sofisticado. Gracias a su estudiado giro podemos orientar la luz prácticamente en cualquier dirección.

BY NACHO TIMÓN
REF 63035 GOLD - WHITE - BLACK





GIRO
REF 63035 GOLD - WHITE - BLACK



PROXIMA

A timeless piece which unmistakable authorship reports about the richness of shades and treatment of materials.

Un clásico atemporal cuya autoría inconfundible se delata por la riqueza de matices y tratamiento de los materiales.



BY MIQUEL MILÁ
REF 62004 GLAZED NICKEL



MAYA

BY MERMELADA ESTUDIO
REF 60060 BLACK







REF 63031 FOG BLUE



Maya is a modular lamp, that can grow, generating different compositions because of its hexagonal geometry and conicity inspired in a beehive.

Maya es una lámpara modular, que puede crecer generando diferentes composiciones gracias a su geometría cónica y hexagonal inspirada en los panales de abejas.

▲ 60061 CORAL PINK - 60062 BURGUNDY



BLOW Collection



BY CLAUDIO ZAPPONE - GIORGIO PALERMO

◀ MINI BLOW REF 60025 WHITE

BLOW REF 60058 GLAZED NICKEL ▶



▲ BLOW REF 60024 GLAZED NICKE

BLOW REF 60046 GLAZED NICKEL ►



Blow is a timeless collection inspired by sputnik lamps designed in the 50's. Every piece transmits warmth and a charming light than envelops spaces with sophistication and elegance.

Blow es una colección atemporal inspirada por las lámparas Sputnik diseñadas en los 50. Cada pieza transmite calidez y una iluminación amable que envuelve los espacios con sofisticación y elegancia.





REF 60046 GLAZED NICKEL



LUSTROGRAD
ОПТОВЫЕ ПРОДАЖИ СВЕТИЛЬНИКОВ



BLOW & Mini BLOW wall lamp

BY CLAUDIO ZAPPONE - GIORGIO PALERMO

Mini BLOW 63019 GOLD

BLOW 64012 NICKEL

COCO 61060 CHROME

LUSTROGRAD
ОПТОВЫЕ ПРОДАЖИ СВЕТИЛЬНИКОВ





BLOW table lamp

BY CLAUDIO ZAPPONE - GIORGIO PALERMO

REF 61041B GOLD

MINIMA 62032 SOFT GREEN ▲

LUSTROGRAD
ОПТОВЫЕ ПРОДАЖИ СВЕТИЛЬНИКОВ





CONE Collection

Focused on the simplicity of its shapes, reducing its morphology to a set of basic pieces that play with light direction.

Una apuesta por la simplicidad de las formas, reduciendo su morfología a un juego de piezas básicas que juegan con la orientación de la luz.

BY ROGER PERSSON

◀ REF 610454 WHITE

PENDANT 60085B CHROME ▶





PENDANT 60085B GOLD

FLOOR LAMP 62031 BLACK

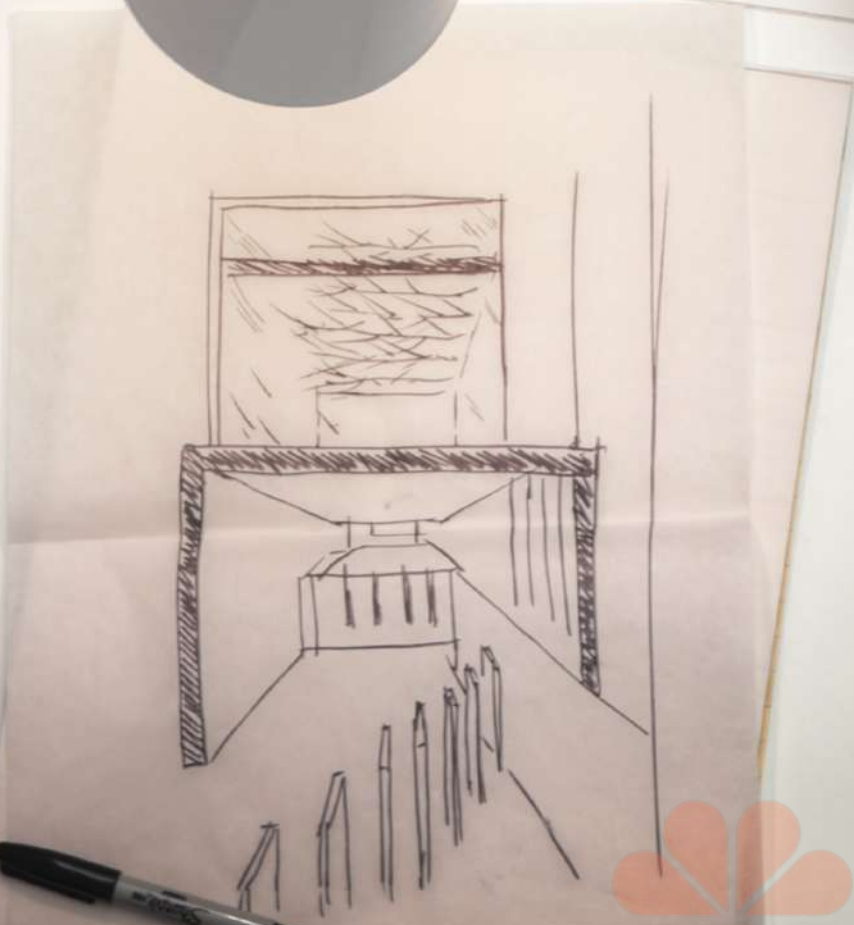



CAP

Focused on the simplicity of its shapes, reducing its morphology to a set of basic pieces that play with light direction.

Una apuesta por la simplicidad de las formas, reduciendo su morfología a un juego de piezas básicas que juegan con la orientación de la luz.

BY LUIS ESLAVA
REF 61046 WHITE



PENSILIS

Wall collection of rotund and simple geometry inspired by origami. Can be installed independently or create diverse sets by playing with all four sizes and their disposition.

Colección mural de geometría rotunda y sencilla inspirada en la papiroflexia. Puede instalarse de forma independiente o crear diversos conjuntos con los cuatro tamaños y su disposición.

BY CÍSCAR & GARCIA

REF 63026 - 63027 - 63028 - 63029 WHITE - BLACK



HOFFMAN

Timeless and versatile for all types of spaces and projects. Hoffman is an off-road piece for its classic and polished aspect.

De carácter atemporal y polivalente para todo tipo de espacios y proyectos. Hoffman es una pieza todoterreno por su aspecto clásico y depurado.

BY ESTUDIO ALMERICH

60001 BLACK - 60002 BLACK / GOLD - 60003 BLACK







TECHNICAL INFO

INTRODUCTION

All the Lighting fixtures of this catalogue are produced in our Factory in Valencia (Spain). The label MADEINEU ® guarantees that the design and manufacturing process of this product are European. We have always worked with freelance designers from different nationalities, what is reflected in the International personality of our designs.

We offer an important and differentiator competitive advantage for the Contract business as we can make any formal change in any of our Exclusive Designs to adapt them for our customer's projects.

The Designs included in this technical brochure are original and exclusive by ALTIMA INNOVA, S.L.

RECOMENDATIONS

We advise to install the lamps respecting the maximum voltages as indicated in this technical catalogue for each model. In case you want to use different bulbs as suggested, we welcome you to ask our technical department before for approval in advance in order to avoid possible damages to the fixture. In case that you do not proceed in such way, we are not responsible of any harm caused to the fixture for such reason. All our fixtures comply with all technical specifications and certifications for the country of destiny. All our fixtures have a guarantee label that also mentions the maintenance and assembling. Please be welcome to send us any request that you may have by mail to export@almerich.com or by phone (+34) 961 343 234

Altima Innova bets for the constant improvement of its products so the design, configuration or specifications in this catalogue may vary.

© Copyright 2017. ALTIMA INNOVA, S.L.

INTRODUCCIÓN

Todas las Luminarias que componen este Catálogo Técnico están fabricadas en nuestras instalaciones de Valencia-España. La etiqueta MADEINEU ® garantiza que el diseño y la fabricación de este producto son europeos. Desde siempre colaboramos con diseñadores Free-Lance de diferentes nacionalidades, ofreciendo al mercado Diseños con un marcado carácter Internacional.

Ofrecemos una ventaja competitiva muy importante y diferenciadora para el mercado del Contract, podemos realizar cambios formales sobre todos nuestros Diseños Exclusivos adaptándolos tanto en medidas como en acabados para los Proyectos de nuestros clientes, así como otras peticiones que se nos requieran.

Los diseños con contienen este catálogo-técnico son originales y exclusivos de "ALTIMA INNOVA, S.L."

RECOMENDACIONES

Se recomienda instalar lámparas respetando los máximos de potencia que se indican en este Catálogo Técnico para cada una de las Luminarias. En caso de querer emplear lámparas diferentes a las indicadas aconsejamos nos hagan previamente la consulta para que nuestro Departamento Técnico les informe sobre su conveniencia o no y así poder evitar daños en la luminaria donde se instalen, en caso de no hacerlo no nos hacemos responsables de ningún daño que esto pudiese ocasionar. Todas nuestras Luminarias cumplen las Especificaciones Técnicas y Certificaciones que se requieren en el país de destino. A todas nuestras Luminarias se les adjunta una Etiqueta de Garantía en la que además se especifica el mantenimiento y montaje de las Luminarias. Cualquier consulta que desee hacernos puede realizarla por medio de nuestro correo electrónico export@almerich.com o telefónicamente al (+34) 961 343 234

Altima Innova apuesta por la constante mejora de sus productos, por lo que el diseño, configuración y especificaciones que aparecen en este catálogo técnico pueden estar sujetas a modificaciones.

© Copyright 2017. ALTIMA INNOVA, S.L.

	PAG	REF	COLLECTION COLECCIÓN
<hr/>			
PENDANTS COLGANTES			
<hr/>			
	98	60052	BOOMERANG
	98	60046	BLOW
	98	60058	BLOW
	99	60024	BLOW
	99	60025	miniBLOW
	99	60085	CONE
	100	60001	HOFFMAN
	100	60002	HOFFMAN
	100	60003	HOFFMAN
	100	60060	MAYA
	100	60061	MAYA
	101	60062	MAYA
	101	60088	MOON
	101	60089	MOON
	102	60086	PARTY
	102	60087	PARTY
	102	60081	PARTY
	103	60050	REM
	103	60051	REM
	103	60071	TRIA
	103	60068	TRIA
<hr/>			
TABLE LAMPS SOBREMESAS			
<hr/>			
	104	61041	BLOW
	104	61046	CAP
	104	61054	CONE
	105	61060	COCO
	105	61061	COCO small
	105	61057	MINIMA
	106	61059	MINIMA
	106	61058	MINIMA
	106	61063	MOON
	107	61044	SELF
	107	61050	TRIA
<hr/>			
FLOOR LAMPS LÁMPARAS DE PIE			
<hr/>			
	108	62023	BOOMERANG
	108	62030	CONE
	108	62031	CONE
	108	62032	MINIMA
	109	62033	MINIMA
	109	62026	MONSIEUR
	109	62034	MOON
	110	62004	PROXIMA
	110	62029	TOWER
	110	62025	TRIA
<hr/>			
WALL LAMPS APLIQUES			
<hr/>			
	111	64012	BLOW
	111	63019	miniBLOW
	111	63035	GIRO
	112	63031	MAYA
	112	63021	TRIA
	112	63026	PENSILIS
	112	63027	PENSILIS
	112	63028	PENSILIS
	112	63029	PENSILIS
<hr/>			
CEILING LAMPS PLAFONES			
<hr/>			
	113	64012	BLOW
	113	63019	miniBLOW
	113	64019	RAINING DAY
	113	64020	RAINING DAY
	113	64021	RAINING DAY

HANGING LAMPS COLGANTES

BOOMERANG

LUIS ESLAVA

REF 60052

MATERIAL
Coated steel sheets and glass

MATERIAL
Plancha de acero lacado

LED
E27 GLOBUS 13W 270° x 1 unit

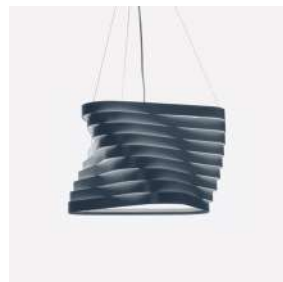

30
11,8"

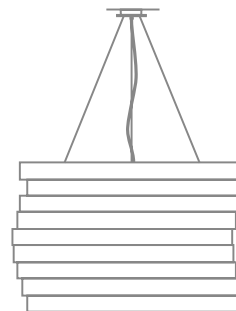

44
17,3"

LAQUERED



BLOW

CLAUDIO ZAPONNE & GIORGIO PALERMO

REF 60046

MATERIAL
Rotational moulded polymer diffusers and steel structure.

MATERIAL
Difusor de polimero por rotomoldeo y estructura de acero

LED
E27 7W 360° x 2 units



22
8,65"

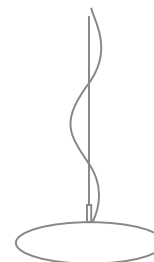

50
19,7"

LAQUERED



METALLICS



BLOW

CLAUDIO ZAPONNE & GIORGIO PALERMO

REF 60058

MATERIAL
Rotational moulded polymer diffusers and steel structure.

MATERIAL
Difusor de polimero por rotomoldeo y estructura de acero

LED
E27 7W 360° x 18 units

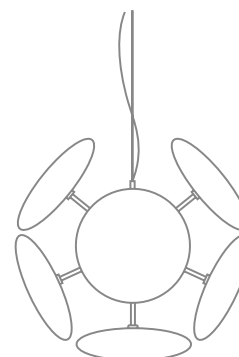
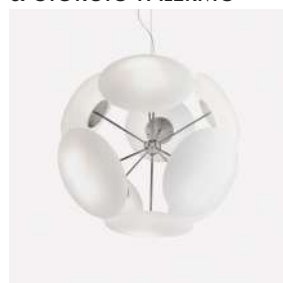

103
39,4"

100
40"

LAQUERED



METALLICS



BLOW

CLAUDIO ZAPONNE
& GIORGIO PALERMO

REF 60024

MATERIAL

Rotational moulded polymer diffusers and steel structure.

MATERIAL

Difusor de polimero por rotomoldeo y estructura de acero.

LED

E27 7W 360° x 34 units

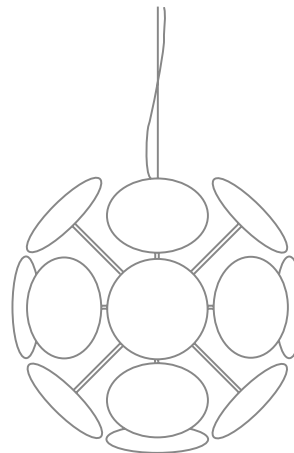

146
57,5"

144
56,7"

LAQUERED



METALLICS



mini BLOW

CLAUDIO ZAPONNE
& GIORGIO PALERMO

REF 60025

MATERIAL

Pyrex diffusers and steel structure.

MATERIAL

Difusor de pyrex y estructura de acero.

LED

G9 4W 360° x 13 units

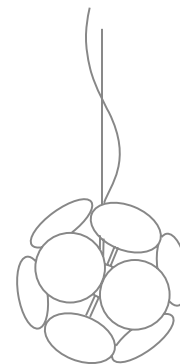

56
22"

50
19,7"

LAQUERED



METALLICS



CONE

ROGER PERSSON

REF 60085

MATERIAL

Steel
Laquered

MATERIAL

Acero
Lacado

LED

E27 12W x 1 unit

REF 60085B

MATERIAL

Steel
Metallic finish

MATERIAL

Acero
Acabado metálico

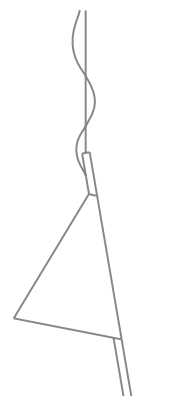

22
8,65"

13
5,1"

LAQUERED



METALLICS



HOFFMAN
ESTUDIO ALMERICH

REF 60001 - 60002 - 60003

60001

60002

60003



MATERIAL
Opal glass and brass

MATERIAL
Vidrio opal y latón

LED
E27 7W 360° x 1unit
E27 9W 360° x 1unit
E27 12W 360° x 1unit

24
9,45"



31
12,2"

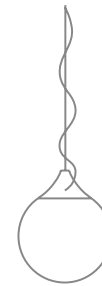

36
14,2"

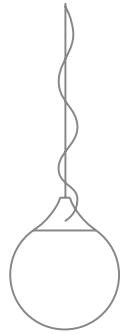

18
7"

25
9,8"

30
11,8"

LAQUERED



METALLICS



MAYA

MERMELADA ESTUDIO

REF 60060



MATERIAL
Aluminium

MATERIAL
Aluminio

LED
E27 12W 360° x 1unit

38,5
15,1"

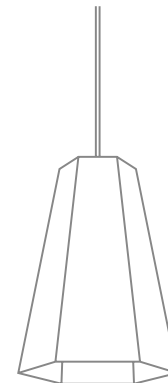

25
9,8"

LAQUERED



MAYA

MERMELADA ESTUDIO

REF 60061



MATERIAL
Aluminium

MATERIAL
Aluminio

LED
E27 12W 360° x 3 units

38,5
15,1"

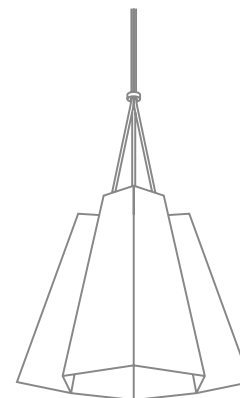

45
17,7"

LAQUERED



MAYA

MERMELADA ESTUDIO

REF 60062

MATERIAL
Aluminium

MATERIAL
Aluminio

LED
E27 12W 360° x 6 units

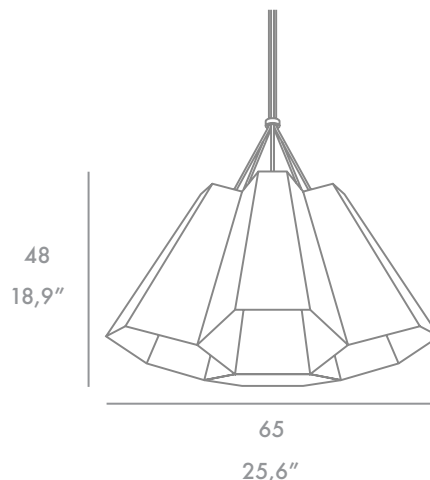

LAQUERED



MOON NEW!

AGUS KIM

REF 60088

MATERIAL
Steel
Laquered

MATERIAL
Aluminio
Lacado

LED
E14 4W
E27 7W
E27 9W



REF 60088B

MATERIAL
Steel
Metallic

MATERIAL
Acero
Metálico

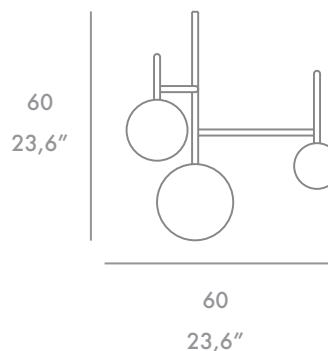

LAQUERED



METALLICS



MOON NEW!

AGUS KIM

REF 60089

MATERIAL
Aluminium
Laquered

MATERIAL
Aluminio
Lacado

LED
E14 4W x 2 units
E27 7W x 2 units
E27 9W



REF 60089B

MATERIAL
Steel
Metallic

MATERIAL
Acero
Metálico

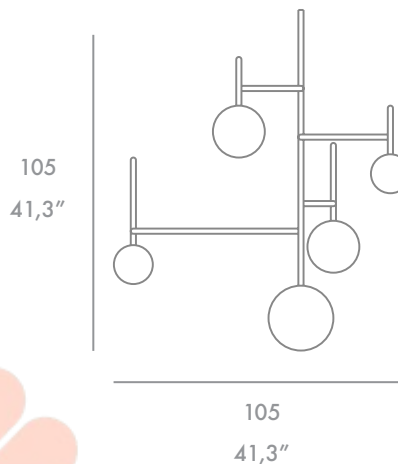

LAQUERED



METALLICS



PARTY

ARNAU REYNA

REF 60086

MATERIAL
Brass

MATERIAL
Latón



LED (INCLUDED)
E27 7W x 10 units

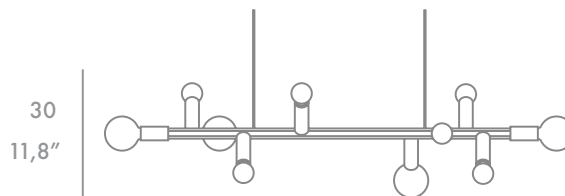

LAQUERED

METALLICS



Warm light
Luz cálida

137

53,9

PARTY

ARNAU REYNA

REF 60087

MATERIAL
Brass

MATERIAL
Latón



LED (INCLUDED)
E27 7W x 10 units

118
46,5"

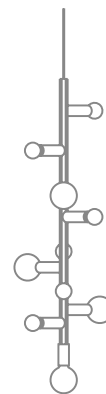

LAQUERED

METALLICS



Warm light
Luz cálida

30

11,8

PARTY

ARNAU REYNA

REF 60081

MATERIAL
Brass

MATERIAL
Latón



LED (INCLUDED)
E27 7W x 7 units

59
23,2"

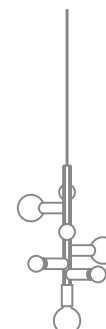

LAQUERED

METALLICS



Warm light
Luz cálida

30

11,8



REM
YONOH

REF 60050 - 60051



MATERIAL
Aluminium

MATERIAL
Aluminio

LED
E27 GLOBUS 13W 270° x 1unit

50
19,65"

60050

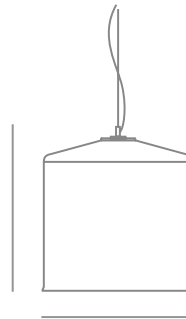

46
18"

60051

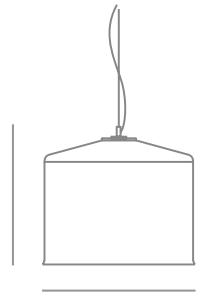

40
15,75"

46
18"

LAQUERED



TRIA

LUIS ESLAVA

REF 60071B

REF 60071



MATERIAL
Steel

MATERIAL
Steel and textile shades

MATERIAL
Acero

MATERIAL
Acero y pantallas textiles

LED
E14 4W x 5 units

44
17,3"

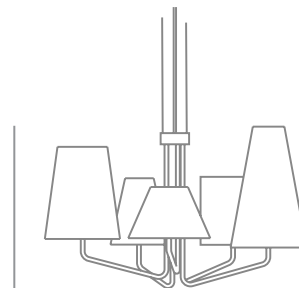

70
27,55"

LAQUERED



TEXTILES



TRIA

LUIS ESLAVA

REF 60068B

REF 60068



MATERIAL
Steel

MATERIAL
Steel and textile shades

MATERIAL
Acero

MATERIAL
Acero y pantallas textiles

LED
E14 4W x 8 units

54
21,3"

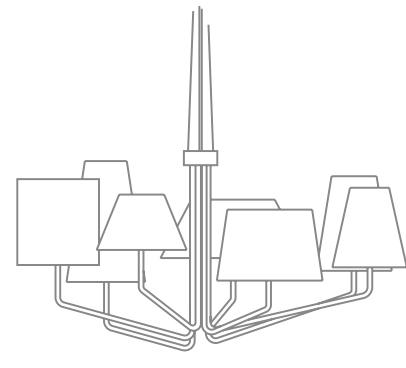

115
45,3"

LAQUERED



TEXTILES



TABLE LAMPS SOBREMESAS

BLOW

CLAUDIO ZAPONNE & GIORGIO PALERMO



REF 61041

MATERIAL
Plastic diffuser and steel structure. Epoxi finish. Outdoor / indoor

MATERIAL
Difusor de plástico y estructura de acero. Pintura epoxi. Exterior / interior

LED
E 27 7W 360° x 2 units

REF 61041B

MATERIAL
Plastic diffuser and steel structure. Metallic finish. Only indoor

MATERIAL
Difusor de plástico y estructura de acero. Acabado metálico. Sólo para interior

19,5
7,7"

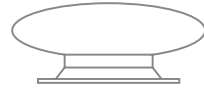
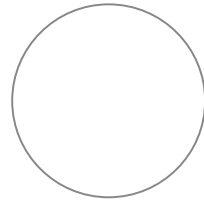

50
19,7"

LAQUERED



METALLICS (Only indoor / solo para interiores)



CAP

LUIS ESLAVA



REF 61046

MATERIAL
Aluminium and steel

MATERIAL
Aluminio y acero

LED
GU10 7W x 1 unit

44
17,3"

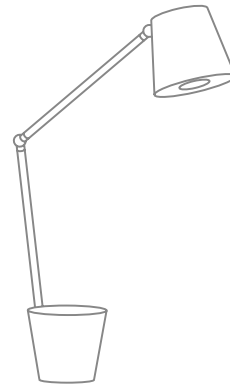

40
15,75"

LAQUERED



CONE

ROGER PERSSON



REF 61054

MATERIAL
Aluminium
Laquered

MATERIAL
Aluminio
Lacado

LED
E27 12W x 1 unit

REF 61054B

MATERIAL
Aluminium
Metallic finish

MATERIAL
Aluminio
Acabado metálico

68
9,8"

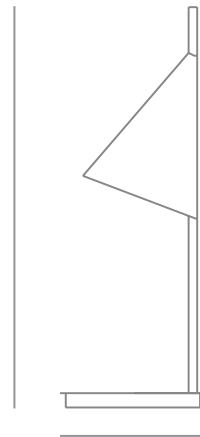

25
26,8"

LAQUERED



METALLICS



COCO
ESTUDIO SAVAGE



REF 61060
MATERIAL Aluminium Laquered
MATERIAL Aluminio Lacado

REF 61060B
MATERIAL Brass Metallic finish
MATERIAL Latón Acabado metálico

LED
E27 GLOBUS 9W Ø 95 x 1 unit

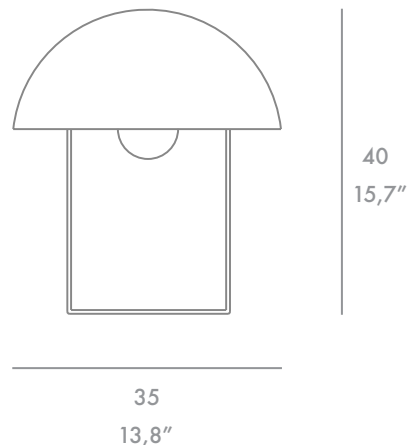

LAQUERED



METALLICS



COCO SMALL NEW!
ESTUDIO SAVAGE



REF 61061
MATERIAL Aluminium Laquered
MATERIAL Aluminio Lacado

REF 61061B
MATERIAL Brass Metallic finish
MATERIAL Latón Acabado metálico

LED
E27 7W x 1 unit



LAQUERED



METALLICS



MINIMA
ESTUDIO SAVAGE



REF 61057
MATERIAL Brass
MATERIAL Latón

LED
E14 7W x 1 unit

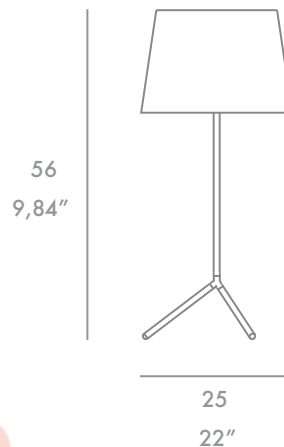

LAQUERED



METALLICS



MINIMA
ESTUDIO SAVAGE

REF 61059

MATERIAL
Brass

MATERIAL
Latón

LED
E14 7W x 1unit



LAQUERED



METALLICS



82
32,3"



20
7,9"

MINIMA
ESTUDIO SAVAGE

REF 61058

MATERIAL
Brass

MATERIAL
Latón

LED
E14 7W x 1unit



LAQUERED



METALLICS



82
32,3"



16
6,3"

MOON NEW!
AGUS KIM

REF 61063

MATERIAL
Steel
Laquered

MATERIAL
Acero
Lacado

LED
E14 4W
E27 9W



LAQUERED



METALLICS



REF 61063B

MATERIAL
Steel
Metallic

MATERIAL
Acero
Metálico

40
15,7"

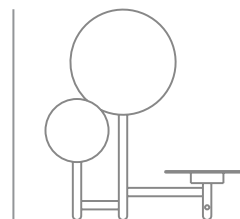

38
15"



SELF

LUIS ESLAVA

REF 61044

MATERIAL
Steel

MATERIAL
Acero

LED
E27 7W x 1unit

LAQUERED



METALLICS

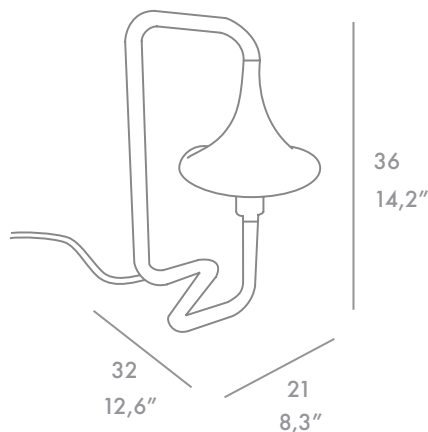

TRIA

LUIS ESLAVA

REF 61050B

REF 61050

MATERIAL
Steel

MATERIAL
Steel and textile shades

MATERIAL
Acero

MATERIAL
Acero y pantallas textiles

LED
E14 4W x 4 units

LAQUERED



TEXTILES (OPTIONAL)

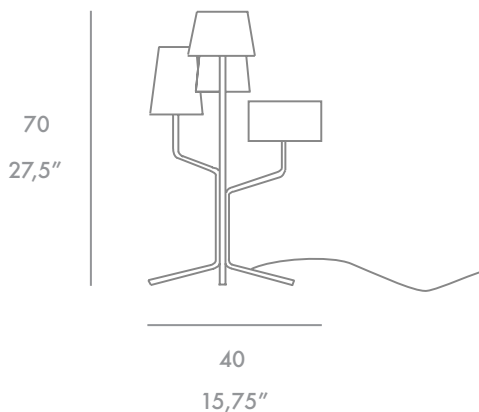

FLOOR LAMPS LAMPARAS DE PIE

BOOMERANG

LUIS ESLAVA

REF 62023

MATERIAL
Coated steel sheets

MATERIAL
Plancha de acero lacado

LED
E27 GLOBUS 13W 270° x 1 unit

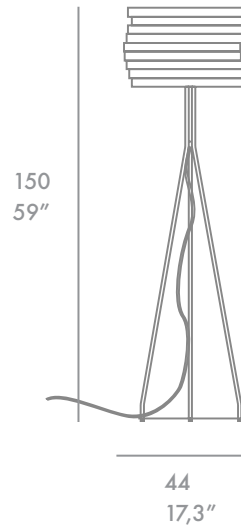

LAQUERED



CONE

ROGER PERSSON

REF 62030 - 62031

MATERIAL
Metal

MATERIAL
Metal

LED
E27 12W x 2 units

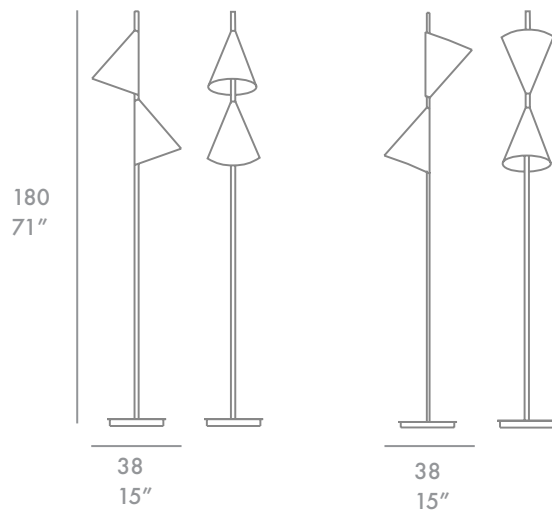

LAQUERED



MINIMA

ESTUDIO SAVAGE

REF 62032

MATERIAL
Brass

MATERIAL
Latón

LED
E14 7W x 1 unit

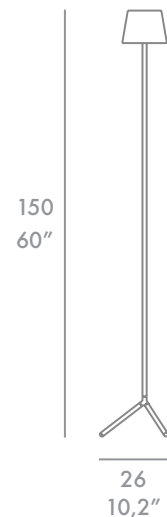

LAQUERED



METALLICS



MINIMA

ESTUDIO SAVAGE

REF 62033

MATERIAL
Brass

MATERIAL
Latón

LED
E14 7W x 1 unit

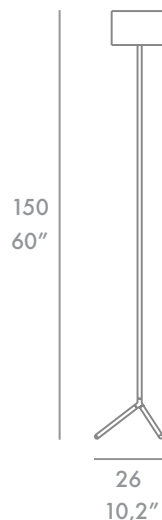

LAQUERED



METALLICS



MONSIEUR

THE EMOTION LAB

REF 62026

MATERIAL
Metal

MATERIAL
Metal

LED
E27 PAR30 12W x 1 unit

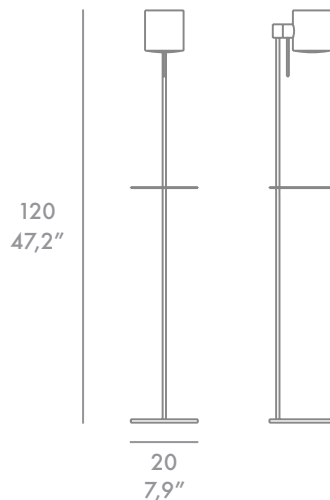

LAQUERED



MOON NEW!

AGUS KIM

REF 62034

MATERIAL
Steel
Laquered

MATERIAL
Acero
Lacado

LED
E14 4W x 1 unit
E27 7W x 1 unit
E27 9W x 1 unit



REF 62034B

MATERIAL
Steel
Metallic finish

MATERIAL
Acero
Acabado metálico

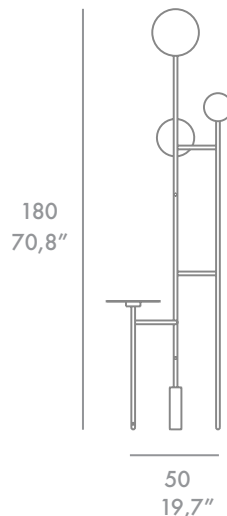

LAQUERED (ALUMINIUM)



METALLICS (STEEL)



PRÓXIMA
MIQUEL MILÀ



REF 62004

MATERIAL
Metal

MATERIAL
Metal

LED
E27 11W° x 1unit

METALLICS



170
67"

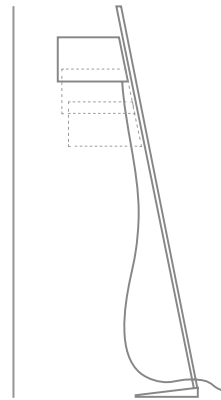

60
23,6"

TOWER
HUGO TEJADA



REF 62029

MATERIAL
Metal

MATERIAL
Metal

LED
E27 13W 270° x 1unit

LAQUERED



140
55"

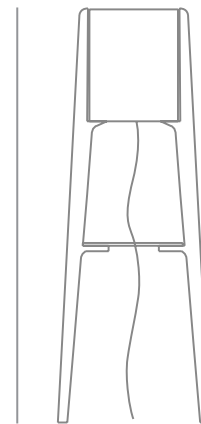

50
19,7"

TRIA
LUIS ESLAVA



REF 62025B

MATERIAL
Steel

MATERIAL
Acero

LED
E14 4W x 4 units

REF 62025

MATERIAL
Steel and textile shades

MATERIAL
Acero y pantallas textiles

LAQUERED



TEXTILES



167
65,75"

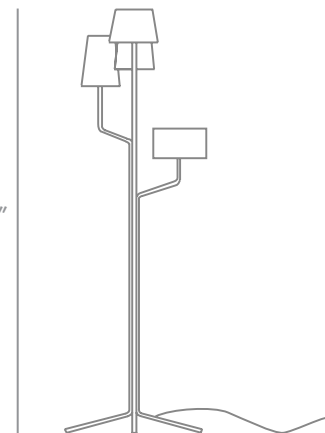

55
21,65"

WALL LAMPS APLIQUES

BLOW

CLAUDIO ZAPONNE & GIORGIO PALERMO

REF 64012

MATERIAL

Rotational moulded polymer diffusers and brass structure.

MATERIAL

Difusor de polimero por rotomoldeo y estructura de latón



LED

E27 7W 360° x 2 units

LAQUERED



METALLICS

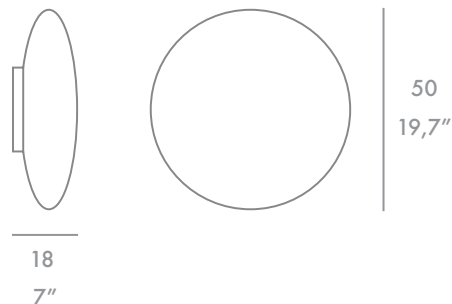
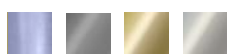

mini BLOW

CLAUDIO ZAPONNE & GIORGIO PALERMO

REF 63019

MATERIAL

Pyrex diffusers and brass structure.

MATERIAL

Difusor de pyrex y estructura de latón



LED

G9 4W 360° x 1unit

LAQUERED



METALLICS

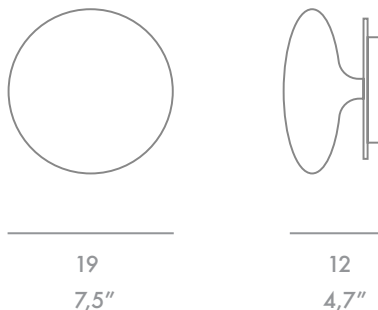
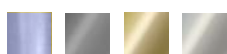

GIRO

NACHO TIMÓN

REF 63035

MATERIAL

Brass

MATERIAL

Latón



LED

GU10 8W x 1unit

LAQUERED



METALLICS

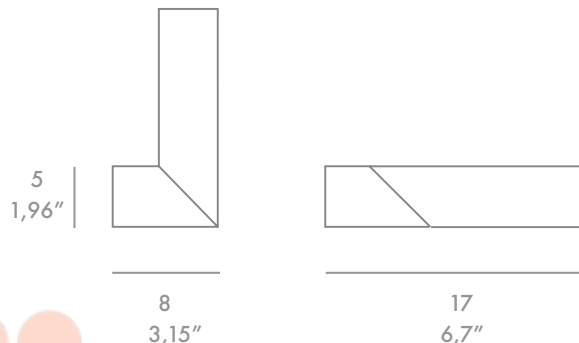

MAYA

MERMELADA ESTUDIO

REF 63031

MATERIAL
Aluminium

MATERIAL
Aluminio

LED
E27 12W x 1 unit



LAQUERED

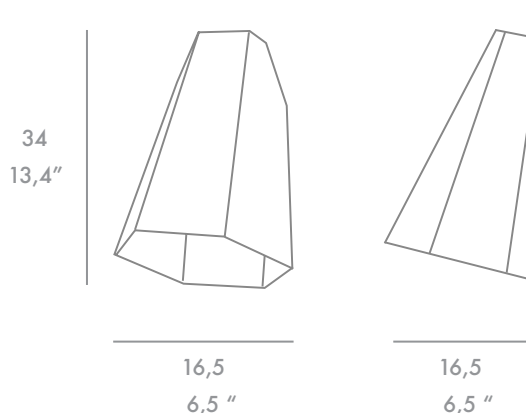

TRIA

LUIS ESLAVA

REF 63021B

REF 63021

MATERIAL
Steel

MATERIAL
Steel and textile shades

MATERIAL
Acero

MATERIAL
Acero y pantallas textiles

LED
E14 4W x 3 units



LAQUERED



TEXTILES

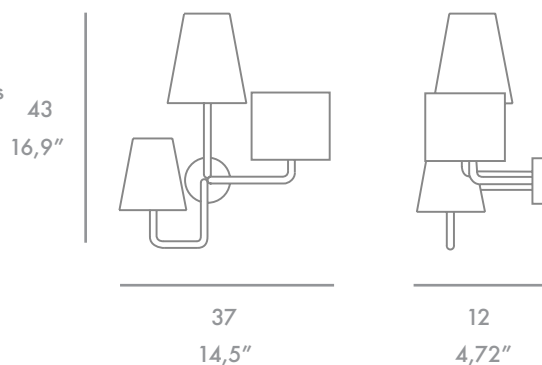

PENSILIS

HERME CISCAR &
MÓNICA GARCÍA

REF 63026 - 63027 - 63028 - 63029

MATERIAL
Aluminium

MATERIAL
Aluminio

LED
63026 - G9 4W x 1 unit
63027 - G9 4W x 1 unit
63028 - 78mm 5W x 1 unit
63029 - 118mm 10W x 1 unit



LAQUERED

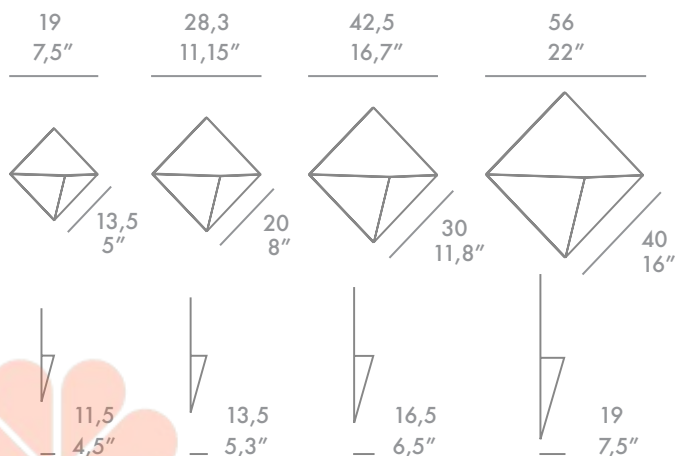

CEILING LAMPS PLAFONES

BLOW

CLAUDIO ZAPONNE & GIORGIO PALERMO

REF 64012

MATERIAL
Rotational moulded polymer diffusers and steel structure.

MATERIAL
Difusor de polimero por rotomoldeo y estructura de acero



LED
E27 7W 360° x 2 units

LAQUERED



METALLICS

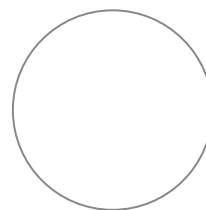

50
19,7"

mini BLOW

CLAUDIO ZAPONNE & GIORGIO PALERMO

REF 63019

MATERIAL
Pyrex diffusers and brass structure.

MATERIAL
Difusor de pyrex y estructura de latón



LED
G9 4W 360° x 1 unit

LAQUERED



METALLICS

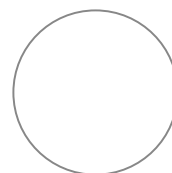

19
7,5"

RAINING DAY

MERMELADA ESTUDIO

REF 64019 - 64020 - 64021

MATERIAL
Steel and lycra

MATERIAL
Acero y lycra



LED
64019 - 7W 360° x 3 units
64020 - 7W 360° x 3 units
64021 - 7W 360° x 8 units

TEXTILES

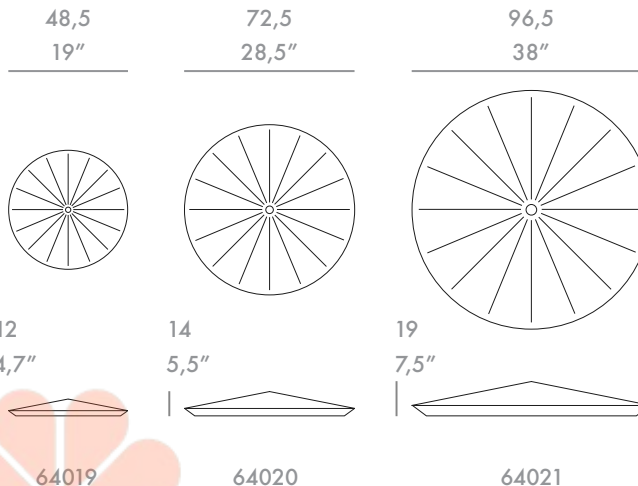

LAQUERED LACADOS

BLACK
NEGRO



TARDIS BLUE
AZUL TARDIS



SLATE BLUE
AZUL PIZARRA



FOG BLUE
AZUL NIEBLA

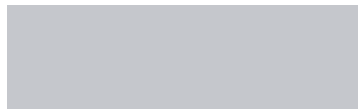

SOFT GREEN
VERDE SUAVE



STONE WHITE
BLANCO PIEDRA

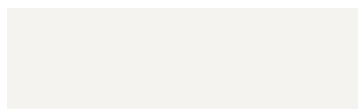

SOFT WHITE
BLANCO SUAVE

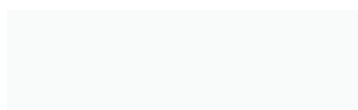

BLUE PASTEL
AZUL PASTEL

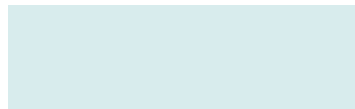

GREY GREEN
VERDE GRISACEO



ENGLISH GREEN
VERDE INGLÉS



AUBERGINE
BERENJENA



BURGUNDY
BORGOÑA



CORAL PINK
ROSA CORAL



QUARTZ PINK
ROSA QUARZO



METALLICS METÁLICOS



FUME
FUMÉ



CHROME
CROMO



GOLD
ORO



GLAZED NICKEL
NIQUEL MATE

TEXTILES TEXTILES



BLACK
NEGRO



DARK RED
ROJO OSCURO

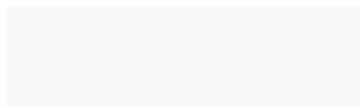

WHITE
BLANCO





www.almerich.com

ALTIMA INNOVA S.L.
Pol. ind. Fuente del Jarro, apartado de correos 55
46988 Valencia (Spain)

Nacional: (+34) 96 134 32 30 - nacional@almerich.com

Export: (+34) 96 134 32 34 - export@almerich.com

Art & Creative direction by Arnau Reyna
Photography by Ángel Segura Foto.

Thanks to SANCAL, PUNT, VICCARBE and CÁRMENES



www.almerich.com