

SLAMP®

THE LEADING LIGHT

COMPENDIUM 2017 / 2018

VISIONARY
ADAPTABLE
SENSUAL
MYSTERIOUS
INNOVATIVE
ACCESSIBLE
RELIABLE
ASPIRATIONAL
ORIGINAL
RESOURCEFUL
EXPERIMENTAL
SUGGESTIVE

ALL RIGHTS RESERVED © SLAMP S.p.A. 2017/2018

EDITOR

Roberto Ziliani

CREATIVE DIRECTION

Luca Mazza

PHOTOS

Massimo Listri (Pages: 26 - 63 - 68 - 82 - 104)

Thomas Pagani

Ezio Gosti

Lorenzo Sechi

PHOTO ASSISTANT

Noemi Patriarca

COPYWRITING

Slamp Press Office

PRE-PRINTED & PRINTED

Euroteam, Brescia

SLAMP S.p.A.

Via Tre Cannelle, 3

00071 - Pomezia, Roma, Italy

tel. +39 06 916 23 91, fax +39 06 916 23 933

info@slamp.com - www.slamp.com

SLAMP:
THE LEADING LIGHT

ALL SLAMP PRODUCTS ARE PRODUCED AND ASSEMBLED IN ITALY

Products are patented throughout the world and conform to the leading electrical safety standards:

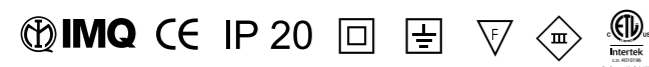

SLAMP S.p.A.

reserves the right to modify price list and/or products without notice in the event of commercial conditions rendering this necessary.







Slight differences of colour in some products in this catalogue are due to the processes involved in printing.

SLAMP S.p.A.

si riserva il diritto di apportare modifiche al listino e ai prodotti senza alcun preavviso, qualora le condizioni commerciali lo rendessero

necessario. Difficoltà di colore di alcuni prodotti sul presente catalogo sono dovute a processi di stampa.

Compendium 2017/2018

	ARIA	18		FIORELLA	236
	ATLANTE	302		FLORA	130
	AURORA	254		GEMMY	324
	AVIA	34		GINETTA	282
	BACH	220		GOCCIA	268
	BATTISTA	272		HANAMI	120
	BIOS	330		HELIOS	278
	CACTUS	258		HUGO	198
	CEREMONY	226		ILLUMINATI	290
	CHANTAL	52		LA LOLLO	102
	CHAPEAU	316		LAS PALMAS	320
	CHARLOTTE	40		LILLIBET	298
	CLIZIA	174		LIZA	92
	CORDOBA	68		LUÌ	334
	CROCCO	232		MEDUSA	294
	DAFNE	274		MILLE BOLLE	308
	DESERT ROSE	114		MIRAGE	210
	DEVIL	286		PUNCTUM	322
	DIAMOND	244		SUPERMORGANA	304
	DIMPLE	164		THE LIGHTNING ARCHIVES	58
	DOME	74		VELI	140
	DRUSA	82		VELI 7	162
	ECSTACITY	338		VENTI	312
	ÉTOILE	190		WOODY	248
	FABULA	214			
	FARETTO	264			

SUSPENSION











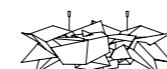
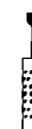
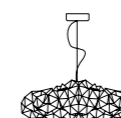
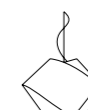
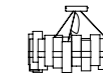
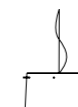

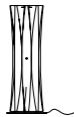



ARIA
PAG. 18ATLANTE
PAG. 302AVIA
PAG. 34BIOS
PAG. 330CACTUS
PAG. 258CEREMONY
PAG. 226CHANTAL
PAG. 52CHAPEAU
PAG. 316CHARLOTTE
PAG. 40CLIZIA
PAG. 174CORDOBA
PAG. 68CROCCO
PAG. 232DAFNE
PAG. 274DESERT ROSE
PAG. 116DEVIL
PAG. 286DIMPLE
PAG. 164DOME
PAG. 74DRUSA
PAG. 82ÉTOILE
PAG. 190FABULA
PAG. 214FARETTO
PAG. 264FIORELLA
PAG. 236FLORA
PAG. 130GEMMY
PAG. 324GINETTA
PAG. 282GOCCIA
PAG. 268HANAMI
PAG. 120HUGO
PAG. 198LA LOLLO
PAG. 104LILLIBET
PAG. 296LIZA
PAG. 94LUÌ
PAG. 334MEDUSA
PAG. 294MILLE
BOLLE
PAG. 308SUPER
MORGANA
PAG. 304VELI
PAG. 140VELI 7
PAG. 162WOODY
PAG. 248

TABLE LAMP

 ATLANTE PAG. 302	 BACH PAG. 220	 BIOS PAG. 330	 CACTUS PAG. 258	 CHAPEAU PAG. 316	 CLIZIA PAG. 174
 DAFNE PAG. 274	 DIAMOND PAG. 244	 FARETTO PAG. 264	 FIORELLA PAG. 236	 GEMMY PAG. 324	 LAS PALMAS PAG. 320
 LIZA PAG. 92	 MILLE BOLLE PAG. 308	 VELI PAG. 140	 VENTI PAG. 312		

CEILING LAMP

 AURORA PAG. 254	 BIOS PAG. 330	 CLIZIA PAG. 174	 CROCCO PAG. 232	 DAFNE PAG. 274
 DRUSA PAG. 82	 ETOILE PAG. 190	 FABULA PAG. 214	 HANAMI PAG. 120	 VELI PAG. 140
 VENTI PAG. 312				

FLOOR LAMP

 BACH PAG. 220	 BATTISTA PAG. 272	 BIOS PAG. 330	 CACTUS PAG. 258	 CHAPEAU PAG. 316
 CHARLOTTE PAG. 40	 CLIZIA PAG. 174	 DAFNE PAG. 274	 DIAMOND PAG. 244	 DIMPLE PAG. 164
 ECSTACITY PAG. 338	 FIORELLA PAG. 236	 FLORA PAG. 130	 GEMMY PAG. 324	 HELIOS PAG. 278
 LAS PALMAS PAG. 320	 LIZA PAG. 92	 MILLE BOLLE PAG. 308	 PUNCTUM PAG. 322	 THE LIGHTNING ARCHIVES PAG. 58
 VENTI PAG. 312	 WOODY PAG. 248			

WALL LAMP

 BIOS PAG. 330	 CLIZIA PAG. 174	 CROCCO PAG. 232	 DAFNE PAG. 274	 DRUSA PAG. 82
 FABULA PAG. 214	 FIORELLA PAG. 236	 ILLUMINATI PAG. 290	 LILLIBET PAG. 298	 MEDUSA PAG. 294
 MILLE BOLLE PAG. 308	 MIRAGE PAG. 210	 PUNCTUM PAG. 322	 VELI PAG. 140	 VENTI PAG. 312



“WITHOUT LIGHT THERE IS NO SPACE”

by Robert Wilson

“La luce è elemento determinante nel processo di creazione dello spazio, punto di inizio e fine di ogni architettura, tanto di un interno quanto di un esterno. Per la strada, in un teatro, in un ristorante e in un ambiente domestico è la luce a definire i confini del mondo in cui viviamo, a dare a ciò che ci avvolge un carattere unico. Parigi sarebbe la stessa senza le sue luci? E cosa sarebbe Roma senza l'incrocio del sole sulle sue architetture? E la Grecia, San Francisco, il Texas? Ci sono luoghi del mondo che varrebbe la pena ricordare senza luce? È in questa abilità nel creare atmosfere memorabili che Slamp trova la sua unicità”.

“Light is the most important element in creating space. It should always be the starting point and the finality of architecture, whether exterior or interior. Light is what creates the worlds we live in, whether on the street, in the theater, in a restaurant, or in your dining room. It is what gives our environment special character. Paris is a beautiful city because of light. Roman light is unique, as is that of Greece, San Francisco, and Texas. And SLAMP lamps are unique in this way.”



Da sinistra: Aria Gold chandelier; ritratto di Zaha Hadid (foto di Steve Double); interno del Heydar Aliyev Centre (Baku, Azerbaijan); ZHA Floating Staircase (London, UK).

From left: Aria Gold chandelier; Zaha Hadid's portrait (photo by Steve Double); interior of the Heydar Aliyev Centre (Baku, Azerbaijan); ZHA Floating Staircase (London, UK).

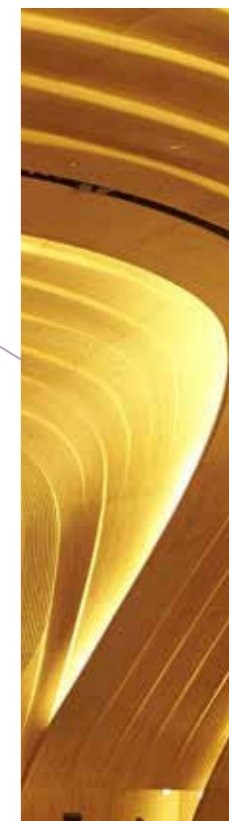

ZAHA HADID

“Light yields endless opportunities, defining the world around us”

“Ricordo quando i miei genitori ordinarono dei nuovi arredi per la nostra casa, per la mia stanza era stato previsto uno specchio dalle linee asimmetriche: mi ha entusiasmato davvero, ed è da lì che è iniziato il mio amore per il design. Avevo 7 anni. Nel 1970, studiando a Londra e guardando le sperimentazioni urbanistiche di Malevich, mi sono sentita spronata a proporre le mie idee per nuove soluzioni architettoniche basate su progresso e innovazione”. Zaha ci ha insegnato che un buon oggetto di design dovrebbe suggerire naturalmente la sua funzione, senza richiedere sforzi intuitivi. Nel lavorare con la luce, poi, bisogna tener conto che essa modifica gli oggetti stessi, il loro colore, la loro texture, la percezione che di essi si ha nello spazio. È in questa funzione di generare infinite opportunità di definire il mondo intorno a noi che la luce trova il suo più profondo significato.

“I remember my parents ordering some new furniture for our home, and for my room there was an asymmetric mirror. I was thrilled by this mirror; it started my love for design. I was 7 years old. As a student in London in the 1970's, I was fascinated by Malevich's experimentation with urbanism, and felt compelled to put forth my own ideas based on innovation and progress, proposing new architectural solutions”. Zaha taught us that design objects should inherently suggest their purpose without forcing one's intuition. In working with light, one must remember that it changes the colour and texture of surrounding objects, as well as their spatial perception. Light's profound significance can be identified in how it generates infinite possibilities of defining the world around us.

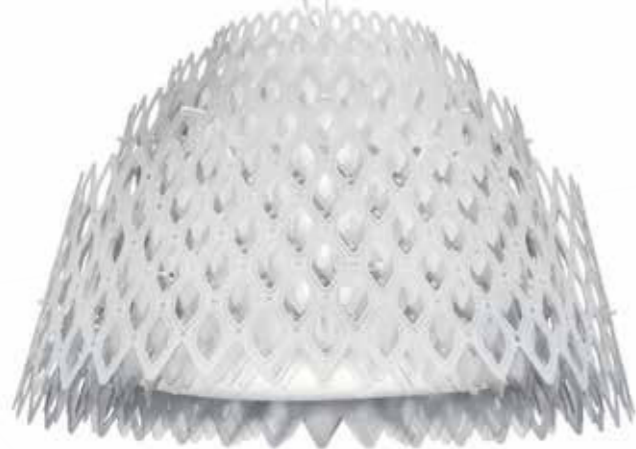

DORIANA AND MASSIMILIANO FUKSAS

“Light is the solidity of architecture”

Progettare gli interni è un atto di amore verso i nostri edifici. La nostra architettura è molto simile, di notte, a lampade che magicamente si illuminano; crediamo fermamente che luce artificiale e naturale siano una delle certezze dell'architettura, gli unici elementi in grado di modificarne totalmente la percezione. La luce è un elemento estremamente importante e prezioso, come un diamante che con la sua purezza riesce a dare differenti colori alla luce che emana, più o meno freddi, fino al rosa.

Interior design is an act of love destined for our buildings. Our architecture, much like lamps, is magically illuminated at night, and we firmly believe that both natural and artificial light are the solidity of architecture, the only elements that can wholly modify perception. Light is extremely important and precious, like a diamond whose pure facets emanate a spectrum of colours ranging from cool to pink.

Da sinistra in senso orario: sospensione Half Charlotte; ritratto di Doriana e Massimiliano Fuksas (foto di Gianmarco Chieriegato); Terminal 3 dello Shenzhen Bao'an International Airport; schizzo a mano della lampada Chantal.

Clockwise from left: Half Charlotte suspension lamp; Doriana and Massimiliano Fuksas' portrait (photo by Gianmarco Chieriegato); Shenzhen Bao'an International Airport - Terminal 3; sketch of Chantal lamp.

Da sinistra in senso orario: ritratto di Daniel Libeskind (foto di Stefan Ruiz); lampada a sospensione Cordoba; Dresden's Military History Museum (Germania); Studio Weil, Maiorca (Spagna).

Clockwise from left: Daniel Libeskind's portrait (photo by Stefan Ruiz); Cordoba suspension lamp; Dresden's Military History Museum (Germany); Studio Weil, Mallorca (Spain).



DANIEL LIBESKIND

“Light is pure love”

L'ispirazione si trova nella vita di tutti i giorni, anche quando si ha a che fare con la luce, che è probabilmente uno degli elementi più misteriosi della realtà, affascinante, complesso e totalmente dinamico; progettare con la luce è una grande gioia e, per me, una grande fortuna. Quando ci appropriamo di uno spazio, grande o piccolo che sia, abbiamo il potere di modificarlo con la luce ed esso, a sua volta, di modificare i nostri sentimenti, le emozioni e il senso della vita. Il design per me è assolutamente appagante, specie se bello e socialmente utile. In generale un buon prodotto, per entrare nella storia, deve fare uso di materiali efficienti e sostenibili, ma soprattutto avere qualcosa di inusuale, di strano...

You have to get inspiration from life, and working with light is no exception. When we inherit a space, albeit large or quite small, we can transform it, which in turn completely transforms our feelings, emotions, and sense of the world. The beauty of design is that it is always rewarding, especially when it is aesthetic and exhibits social ideas. Good design has to use efficient and sustainable materials to endure and create a heritage, and above all, it must have something specifically strange about it. Light is probably the most mysterious dimension of reality, and working with it is fascinating, complex and dynamic. Designing illumination is, well, a great joy, and I can say, I have been very lucky.



STUDIO JOB

“Light is life”

Ci siamo conosciuti durante gli anni della Design Academy e da lì a poco, mossi dall'amore per la vita e da quello tra noi, abbiamo fondato Studio Job. Oggi, dopo quasi 20 anni, alcune cose sono cambiate, altre affatto. Di certo non la passione, la stessa passione che ci ha legato a Slamp, facendoci finalizzare la collezione il giorno di San Valentino mossi dallo stesso autentico sentimento che anima i nostri cuori. Il nostro lavoro si ispira alla vita e agli eroi che hanno fatto parte della nostra giovinezza: David Bowie, Miffy, Roy Lichtenstein, il Green Vault, Warhol e molti altri... Oggi, per la prima volta, con la collezione di 7 nuovi prodotti per Slamp, vediamo i nostri pattern più iconici nascere su una lampada, un'anima luminosa che non necessita di essere illuminata dall'esterno come gli altri oggetti di design e che emana buone vibrazioni. La luce è vita e la nuova collezione di lampade “The Lightning Archives of Studio Job” è un superduper scoop! Collezionatele tutte prima che sia troppo tardi :-)

During our studies at the Design Academy we met and established Studio Job out of sheer love for life and for each other. Now, nearly 2 decades later, some things changed, many things didn't and of course the passion stayed the same. A similar passion binds us to Slamp. The designs for Slamp were appropriately concluded on Valentine's Day and driven by the same authentic elements that define our burning hearts. Our work is inspired by Life itself and the heroes of our youth: David Bowie, Miffy, Roy Lichtenstein, The Green Vault, Warhol and many others... Now, for the first time, our iconic artwork has been applied to 7 new Slamp lamps; unlike other design objects, the good vibrations of this shining soul emanate from within. Life is life, and this new collection “The Lightning Archives of Studio Job” is a superduper scoop! Collect them all before its too late :-)



Da sinistra: dettaglio di The Love Boat per Barneys (foto di Tom Sibley); ritratto di Job Smeets e Nynke Tynagel (foto di Mark Cocksedg); lampada da terra Labyrinth della collezione “The Lightning Archives of Studio Job”

From the left: detail of The Love Boat for Barneys (photo by Tom Sibley); Job Smeets and Nynke Tynagel's portrait (photo by Mark Cocksedg); Labyrinth floor lamp from the collection “The Lightning Archives of Studio Job”



Da sinistra in senso orario: lampada a sospensione Dome; ritratto di Emilia Serra e Andrea Mancuso; collezione “Ordini” per Driade; dettaglio della boutique di Palazzo Fendi, Roma (Italia); istallazione Analogia #001, Londra (UK).

Clockwise from left: Dome suspension lamp; Emilia Serra and Andrea Mancuso's portrait; “Ordini” collection for Driade; Palazzo Fendi's boutique, Rome (Italy); Analogia #001 installation in London (UK).

ANALOGIA PROJECT

“Light gives life to things”

La luce è capace di modificare l'umore delle persone, predisporre a un determinato stato d'animo, aiuta a creare ispirazioni, a influenzare desideri. È proprio questo uno degli elementi più gratificanti del nostro lavoro: coinvolgere emozionalmente le persone. Durante il soggiorno londinese abbiamo imparato a contaminare un'arte con un'altra e oggi, grazie a quell'esperienza, troviamo ispirazione negli oggetti quotidiani, facendo convivere valore estetico e aspetto artigianale, con un linguaggio visivo nuovo e originale. Lavorare con la luce è molto diverso dal progettare altri accessori: la luce è impalpabile e le tecnologie di oggi rendono superflui persino alcuni elementi un tempo indispensabili, come l'interruttore, che spesso lascia il passo a nuove interazioni...

Light is able to directly intervene on a person's mood, suggesting a certain state of mind, creating inspiration and influencing desires. This is the most rewarding thing about our work; we emotionally involve people. During our London stay, we learned how to use contamination amongst diverse art forms. Thanks to that experience, we find inspiration in everyday objects, joining aesthetic value and artisan practices together through a new, original visual language. Working with light is different than working with other elements: light is something that we cannot touch, and technology is making once essential aspects, like the switch, unnecessary, leaving room for new ways in which we can interact with light...

ELISA GIOVANNONI

“Light influences instinctual emotions”

Ho una pessima memoria per i nomi, ma difficilmente dimentico dove ho visto un oggetto, perché mi piaceva o perché lo trovavo strano. Quando ho iniziato, nello studio di Ugo La Pietra, i miei riferimenti erano i maestri del movimento Radicale, ora mi confronto con quello che vedo ogni giorno, consapevolmente, nel senso che so esattamente quello che devo memorizzare per poi riutilizzarne quasi inconsciamente gli stimoli progettuali. Il tema della luce è uno dei più interessanti da svolgere per un designer, sono infatti permesse molteplici possibilità espressive limitate da altrettanti problemi realizzativi. Con l'introduzione della tecnologia LED si è data nuova linfa alla progettualità: è molto stimolante progettare partendo da una nuova tecnologia.

I have a difficult time remembering names, but rarely forget where I saw an object, why I liked it or found it intriguing. When I began working in Ugo La Pietra's studio, my references were the masters of the Radical movement; now, I knowingly face what I see everyday with an exact idea of what I need to memorize in order to use it later, almost unwittingly, as a stimulus for new projects. Light is one of the more interesting mediums to work with as a designer, seeing as its endless expressive possibilities are limited by problems of construction. The evolution of LED technology has brought a fresh take on the act of designing; using new technology is very stimulating.



Da sinistra in senso orario: ritratto di Elisa Giovannoni; collezione di arredi da esterno “Stone” per Vondom; lampada da tavolo Liza Pewter; vassoi Axonometry per Ghidini1961.

Clockwise from left: Elisa Giovannoni's portrait; outdoor furniture from the collection “Stone” for Vondom; Liza Pewter table lamp; “Axonometry” trays for Ghidini1961.

Da sinistra: ritratto di Adriano Rachele; dettaglio della lampada Hanami; dettaglio della lampada Drusa.

From the left: Adriano Rachele's portrait; close-up of Hanami lamp; details of Drusa lamp.



ADRIANO RACHELE

“Light is poetry”

Lavoro con la luce da sempre, è l'unico elemento che dà un'anima visibile agli oggetti, aggiungendogli calore e magia. Perdermi nell'universo creativo fino a realizzare, vedere e toccare ciò che fino a quel momento potevo solo immaginare è la parte più gratificante del mio essere designer. Citando Hopper “Quello che vorrei dipingere è la luce del sole sulla parete di una casa”, lo faccio modellando forme che creano stupore e che fanno godere della poesia del riflesso che producono quando incontrano la luce. Cosa aspettarsi da me in futuro? Sempre qualcosa di romantico e delicatamente emozionante!

I have always worked with light, and it is the only element that gives a visible “soul” to any object, bringing it both warmth and magic. The most gratifying part of being a designer is losing myself in a creative universe where a product begins as a mere figment of my imagination, and transforms into something I can build, see and touch. Hopper stated, “All I wanted to do was paint sunlight on a house wall”. I work by modeling surprising shapes that cast poetic reflections when they encounter light. What should you expect from me in the future? Something eternally romantic and delicately moving.



Da sinistra in senso orario: sospensione La Lollo L Gradient; ritratto di Lorenza Bozzoli; tavolini "Porcini" per Dedon; Wise Men Mirror Mask per Colè.

Clockwise from left: La Lollo L Gradient suspension lamp; Lorenza Bozzoli's portrait; "Porcini" tables for Dedon; Wise Men Mirror Mask for Colè.



LORENZA BOZZOLI

"Light makes a colorful world"

Quando ero bambina amavo curiosare tra i bauli della nonna, che era una cantante lirica. Da lì tiravo fuori le gonne a palloncino e le scarpe dal sapore anni 50 che, in sella al mio Ciao, indossavo per andare al liceo artistico. Mentre fuori imperversava la lotta studentesca, io mi inebriavo della positività e della femminilità che quegli anni avevano lasciato nel mio cuore. È stato proprio un cuore il mio primo oggetto di design, per una mostra in Triennale negli anni 90. Il mio è un mondo a colori, in cui la luce è l'elemento che permette di vedere le mille sfumature che lo compongono. Con le mie lampade cerco di portare nelle case la stessa bellezza di un gioiello sul corpo di una donna.

When I was a little girl, I loved to explore my grandmother's trunks; she was an opera singer. From there, with my bubble skirt and 50's shoes, I would hop on my Ciao motorbike and make my way to high school. While outside, student protests were taking place, I was thrilled by the feminine positivity that filled my heart at the time, and it was a heart that inspired my first design for an exhibition in the Triennale in the 90's. My world is multicoloured, and light is the vessel that transmits the infinite shades it possesses. I design my lamps to adorn a space with the same beauty that jewelry brings to a woman's body.

ZANINI DE ZANINE

"Light evokes a space's atmosphere"

Ho sempre voluto rendere il mio stile riconducibile alla mia terra, il Brasile, attraverso le connessioni create grazie agli scambi oltreoceano, alla sperimentazione di nuove tecnologie e alla fusione dell'artigianato con l'industrial design. Questo è ciò che nel tempo mi ha permesso di tradurre con il design la cultura del mio Paese e di individuare le caratteristiche imprescindibili che ogni oggetto dovrebbe avere: proporzione e funzionalità. Un'installazione luminosa dovrebbe arricchire lo spazio e conferirgli valore in termini di comfort, sia estetico che funzionale. La luce deve trasmettere la bellezza dell'oggetto che la propaga, nel rispetto dell'identità dell'oggetto stesso e nel rispetto dell'esigenza di chi la cerca nello spazio che vuole vivere.

I have always wanted my style to reflect my homeland in Brazil through global exchanges, technological experimentation, and the fusion of handcrafted process applied to industrial design. These design approaches have allowed me, over time, to translate my country's culture and identify the unmistakable characteristics intrinsic to each object: proportion and functionality. A lighting installation should enrich a space, giving it aesthetic value and functional ease. Light should bring beauty to the object that houses it, respecting the object's identity and the necessities of those who have chosen it for their personal space.



Da sinistra in senso orario: sedia Tiss; ritratto di Zanini de Zanine; poltrone Vazada; dettaglio della lampada da terra Flora Pewter.

Clockwise from left: Tiss dining chair; Zanini de Zanine's portrait; Vazada armchairs; details of Flora Pewter floor lamp.

ARIA GOLD BY ZAHA HADID

Visionarie, fluide, dinamiche: le architetture luminose firmate da Zaha Hadid trasferiscono la rivoluzionaria e iconica semantica dell'archistar all'interno di ambienti domestici e recettivi, armonizzando spazio e relazioni umane. Dalle nuove versioni in Gold metallizzato (50, 60 e 70 cm diametro), passando per la prima versione con sfumatura nera (Ø90 cm) e le versioni eteree in policarbonato trasparente, i masterpieces della Hadid si compongono di una struttura radiale composta da 50 layers diversi l'uno dall'altro che avvolgono la sorgente luminosa a LED creando un volume tridimensionale.

Zaha Hadid's luminous architecture is visionary, fluid and dynamic, infusing the revolutionary and iconic semantics of the celebrated architect into domestic and public interiors; the result is the harmonization of beings and their surrounding spaces. From the new metallized Gold (50, 60 and 70 cm), the original version with shaded black edges (Ø90 cm), to the ethereal transparent, polycarbonate versions, Hadid's masterpieces consist of 50 "arms", each diverse from the others, radiating around a voluminous LED source.



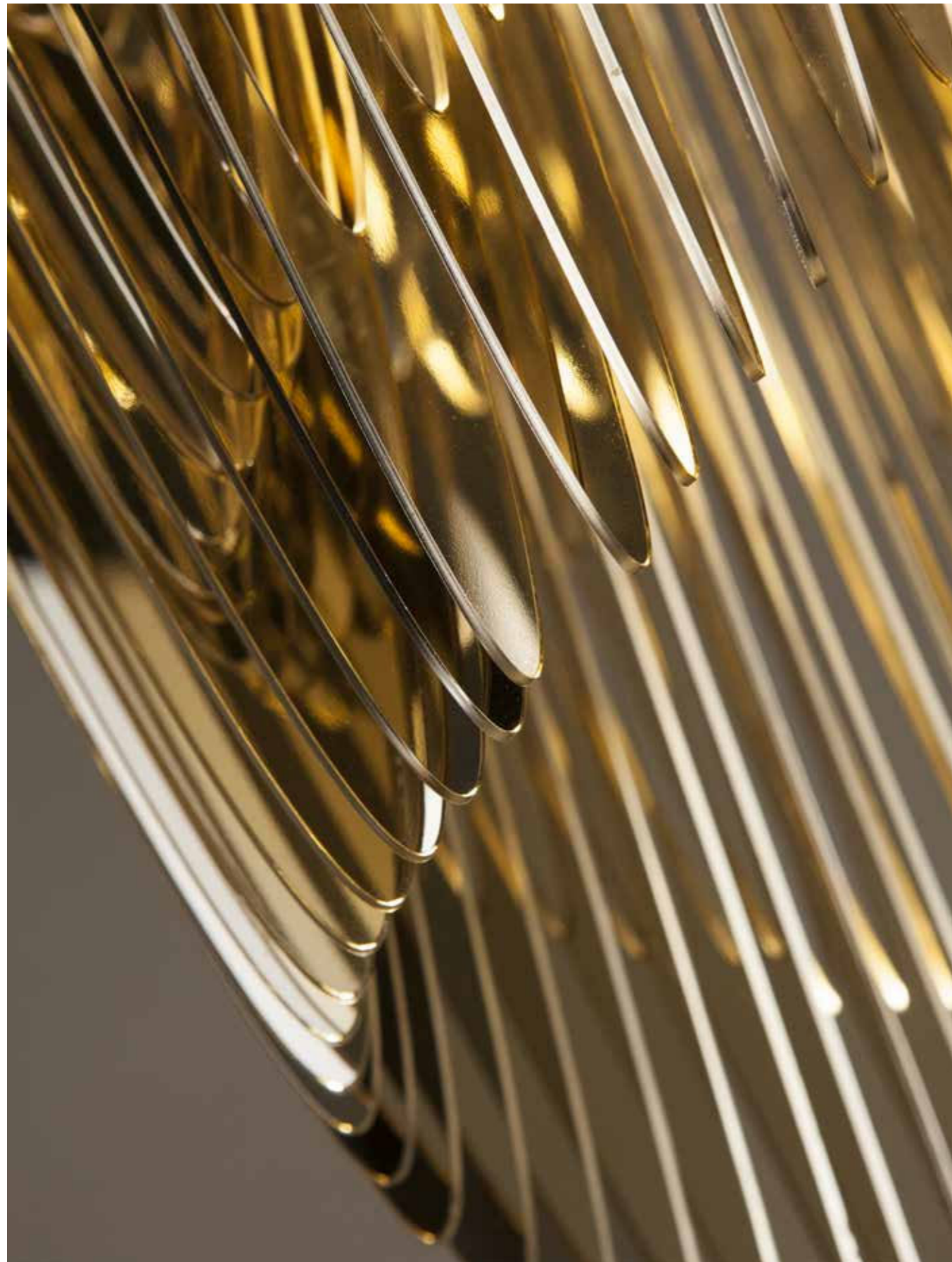



ARIA GOLD L

SUSPENSION

LED: 70W - 220V or 120V
7.000 Lumen - 2700 Kelvin
CRI 90

Triac Dimmable (Trailing Edge min. 20W)

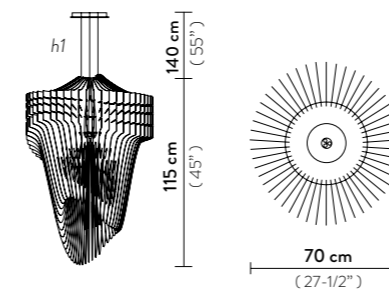

h1: maximum cable length

Made of: Lentiflex® /
Cristalflex® Gold Plated

ARIA GOLD M

SUSPENSION

LED: 35W - 220V or 120V
3.500 Lumen - 2700 Kelvin
CRI 90

Triac Dimmable (Trailing Edge min. 20W)

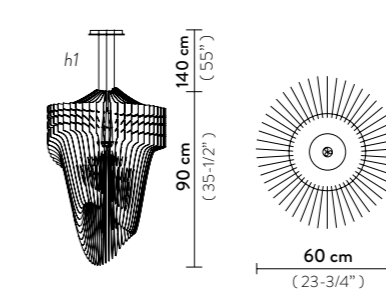

h1: maximum cable length

Made of: Lentiflex® /
Cristalflex® Gold Plated

ARIA GOLD S

SUSPENSION

LED: 35W - 220V or 120V
3.500 Lumen - 2700 Kelvin
CRI 90

Triac Dimmable (Trailing Edge min. 20W)

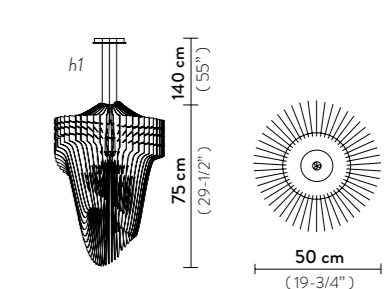

h1: maximum cable length

Made of: Lentiflex® /
Cristalflex® Gold Plated

Price List: page 4



GOLD



ARIA
TRANSPARENT
BY ZAHA HADID

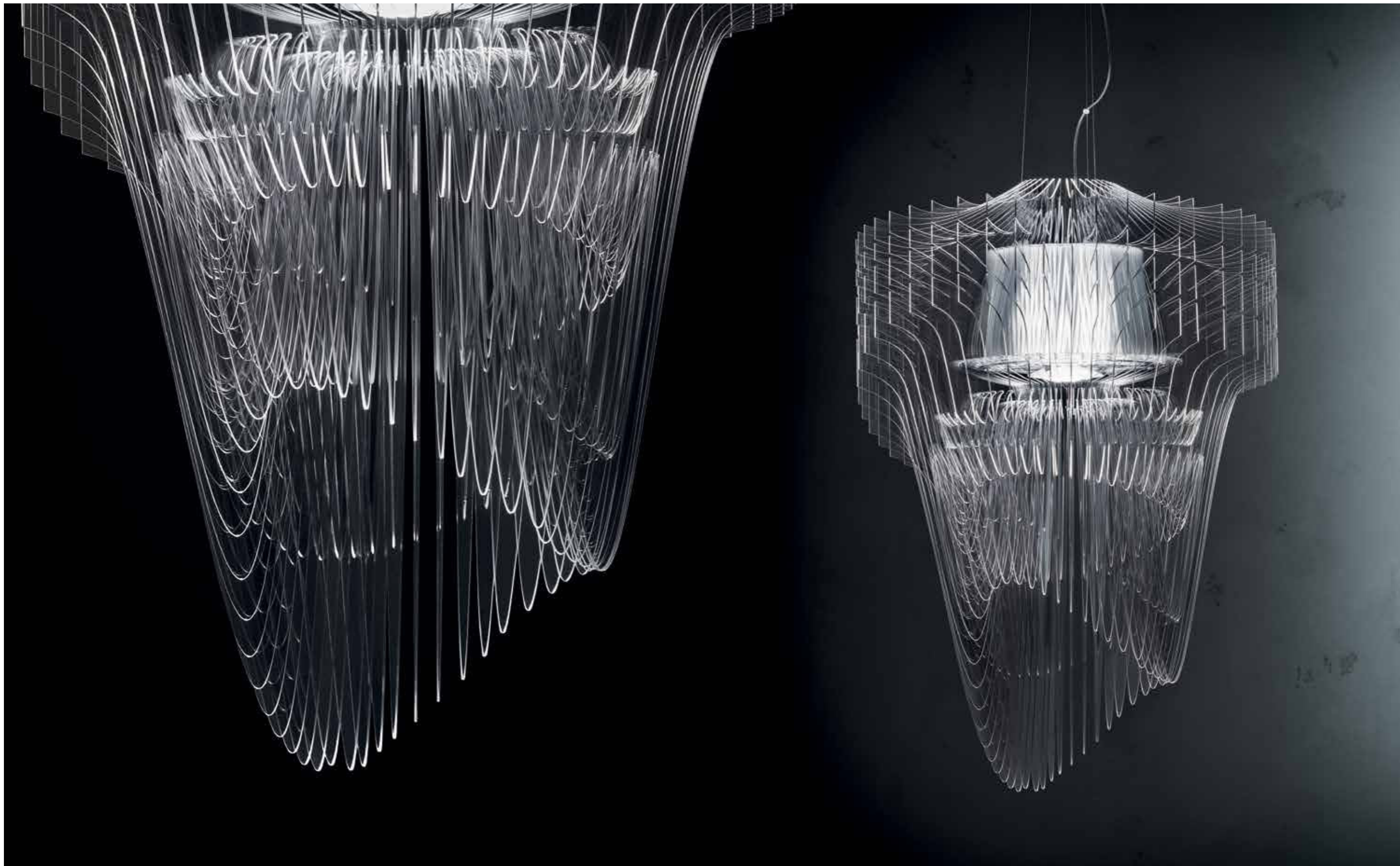



ARIA TRANSPARENT L

SUSPENSION

LED: 70W - 220V or 120V
7.000 Lumen - 2700 Kelvin
CRI 90

Triac Dimmable (Trailing Edge min. 20W)

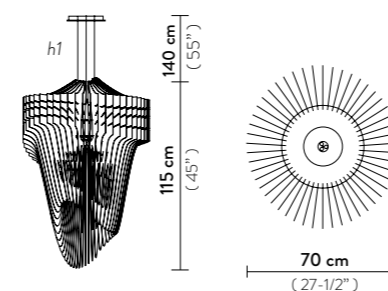

h1: maximum cable length

Made of: Cristalflex® / Lentiflex®

ARIA TRANSPARENT M

SUSPENSION

LED: 35W - 220V or 120V
3.500 Lumen - 2700 Kelvin
CRI 90

Triac Dimmable (Trailing Edge min. 20W)

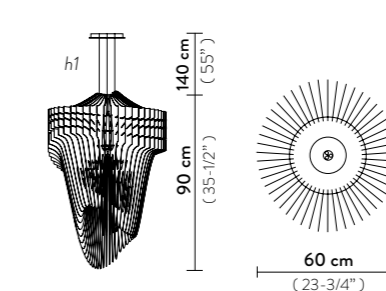

h1: maximum cable length

Made of: Cristalflex® / Lentiflex®

ARIA TRANSPARENT S

SUSPENSION

LED: 35W - 220V or 120V
3.500 Lumen - 2700 Kelvin
CRI 90

Triac Dimmable (Trailing Edge min. 20W)

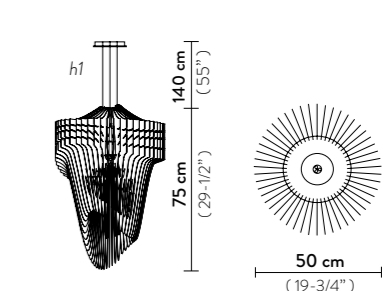

h1: maximum cable length

Made of: Cristalflex® / Lentiflex®

Price List: page 6

TRANSPARENT



ARIA BY ZAHA HADID

ARIA

SUSPENSION

Bulbs: 6 X 8W LED Filament - E27 or E26
+ 1 X 16W Spot LED - E27 or E26

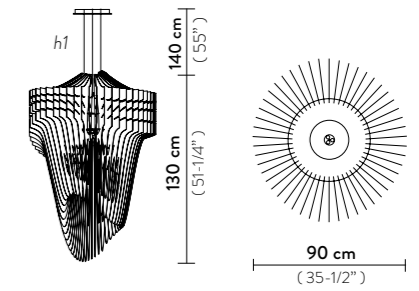

h1: maximum cable length

Made of: Cristalflex® / Lentiflex®

Price List: page 7



Installazione di Aria e Avia white nella Zaha Hadid Gallery di Londra (UK), foto di Luke Hayes.
An installation of Aria and Avia white chandeliers in the Zaha Hadid Gallery (London, UK), photo by Luke Hayes.

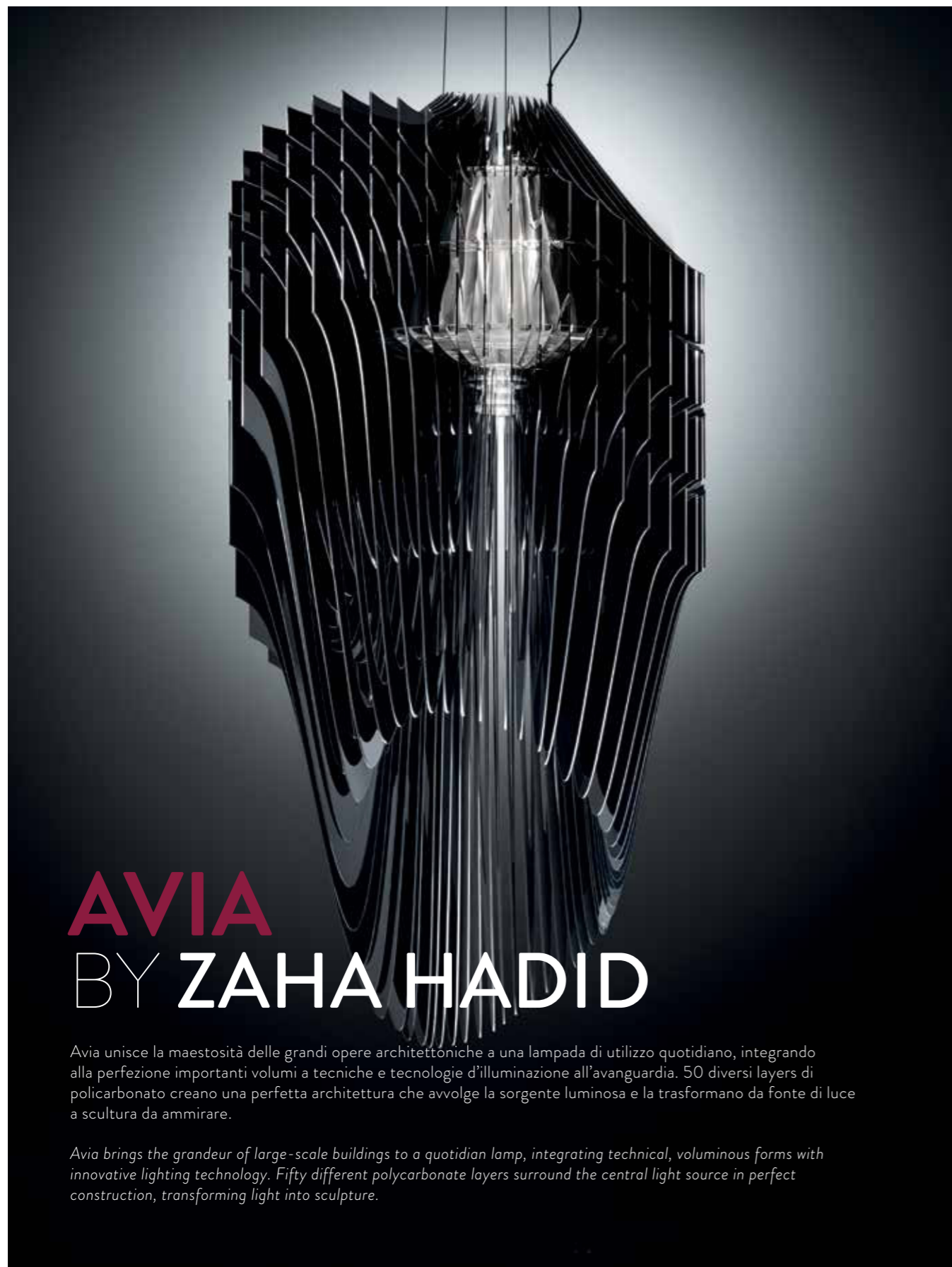

AVIA BY ZAHA HADID

Avia unisce la maestosità delle grandi opere architettoniche a una lampada di utilizzo quotidiano, integrando alla perfezione importanti volumi a tecniche e tecnologie d'illuminazione all'avanguardia. 50 diversi layers di policarbonato creano una perfetta architettura che avvolge la sorgente luminosa e la trasformano da fonte di luce a scultura da ammirare.

Avia brings the grandeur of large-scale buildings to a quotidian lamp, integrating technical, voluminous forms with innovative lighting technology. Fifty different polycarbonate layers surround the central light source in perfect construction, transforming light into sculpture.



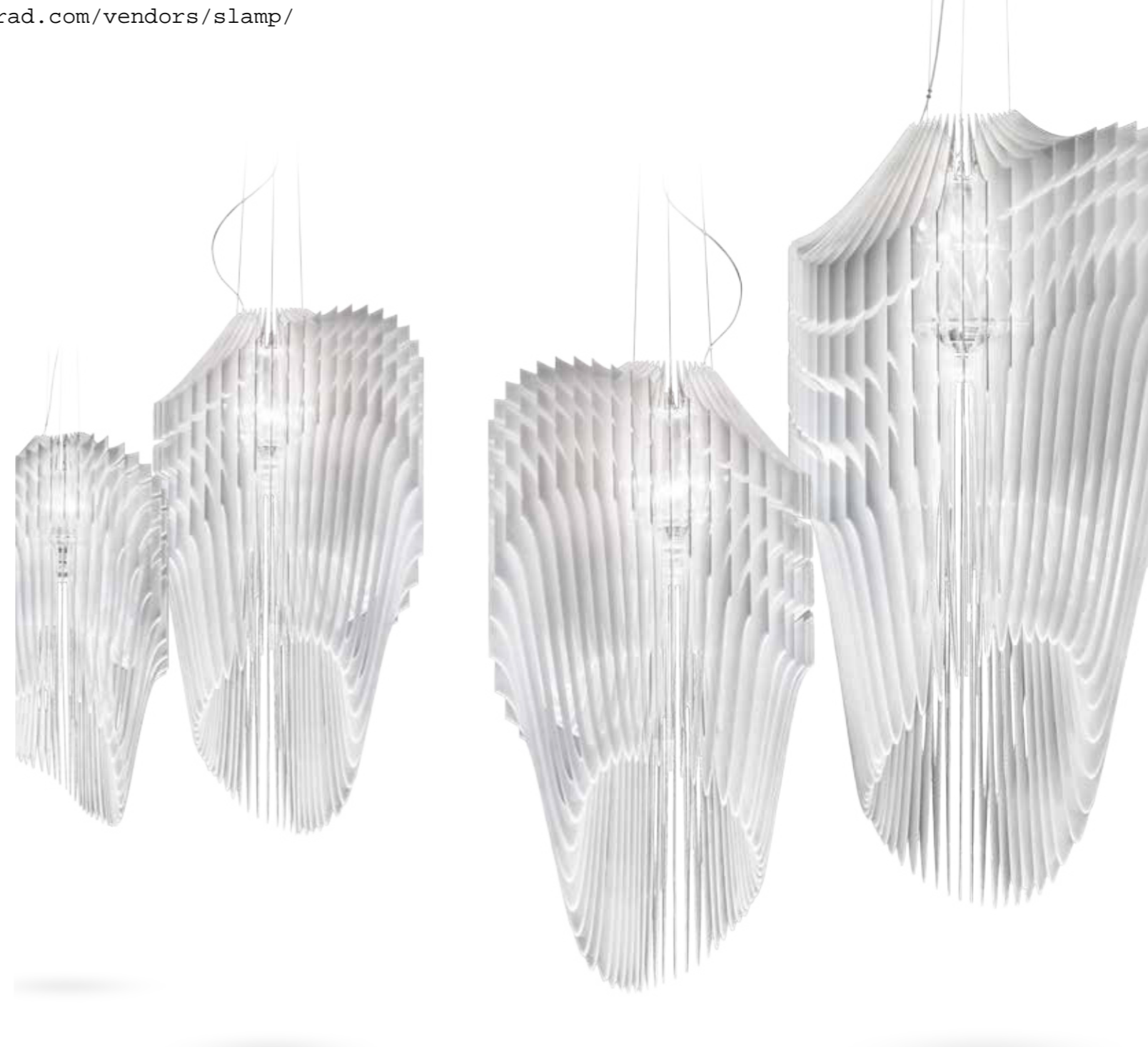

Avia Collection



AVIA XL

SUSPENSION

Bulbs: 6 X 8W LED Filament - E27 or E26
+ 1 X 16W Spot LED - E27 or E26

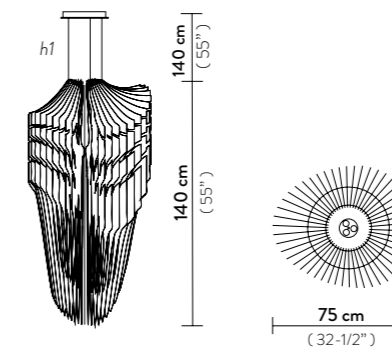

h1: maximum cable length

Made of: Cristalflex® / Lentiflex®

AVIA L

SUSPENSION

Bulbs: 4 X 8W LED Filament - E27 or E26
+ 1 X 16W Spot LED - E27 or E26

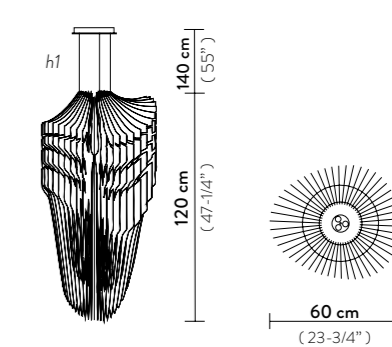

h1: maximum cable length

Made of: Cristalflex® / Lentiflex®

AVIA M

SUSPENSION

Bulbs: 3 X 8W LED Filament - E27 or E26
+ 1 X 11W Spot LED - E27 or E26

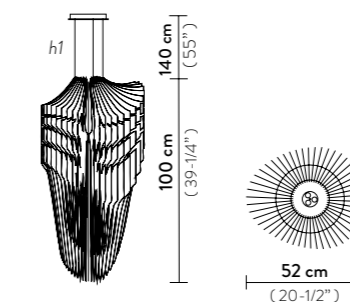

h1: maximum cable length

Made of: Cristalflex® / Lentiflex®

AVIA S

SUSPENSION

Bulbs: 2 X 8W LED Filament - E27 or E26
+ 1 X 11W Spot LED - E27 or E26

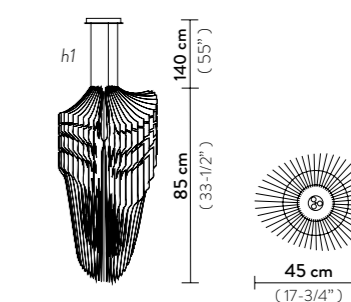

h1: maximum cable length

Made of: Cristalflex® / Lentiflex®

Price List: page 8



CHARLOTTE

BY DORIANA AND MASSIMILIANO FUKSAS

Charlotte nasce dal mondo dell'illusione, dalla sfida di trasformare un elemento bidimensionale in volumi che si moltiplicano all'infinito. Una luce che ricorda il rincorrersi delle onde e la trasparenza del momento in cui si assottigliano, si dematerializzano rinviando interminabili gocce luminose. Charlotte, in tutte le sue multiformi declinazioni, sembra modellarsi da un unico volume con una trama laboriosa, a tratti impalpabile, come quella del nido d'ape, attraverso cui è permesso addentrarsi tramite forme esagonali concentriche per avere una prospettiva ipnotica e sempre nuova da ogni punto di osservazione.

Charlotte was born of illusion, from the challenge of turning a two-dimensional element infinitely multiplying shapes. The light resembles that of waves pulling away from the shore, leaving little illuminated drops behind. Charlotte's sculptural shape seems to be molded from a singular, industrious frame, much like honeycomb with its impalpable elements. Its concentric, hexagonal shapes allow for unending views.



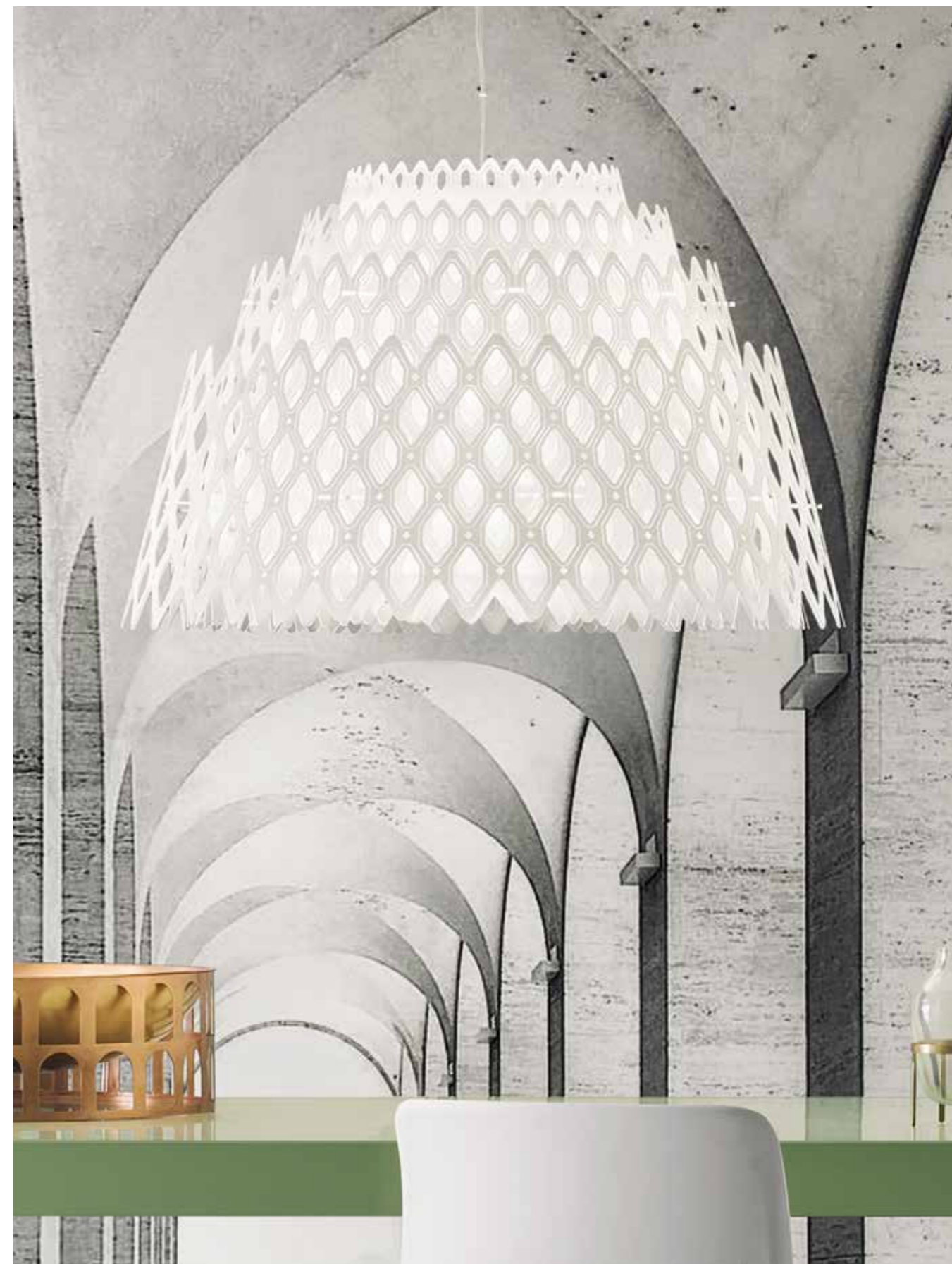

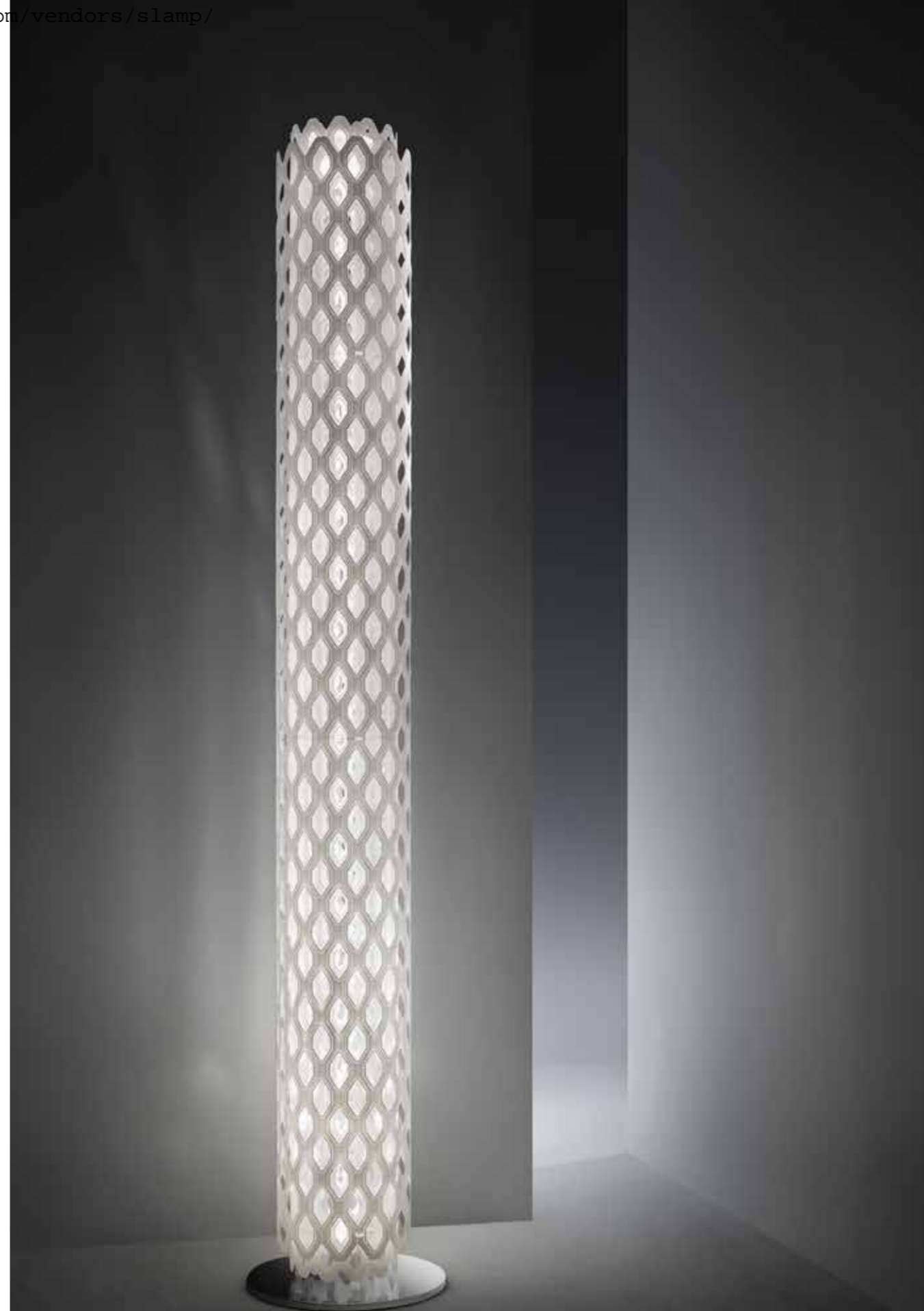



In questa pagina: sospensione Charlotte Orange; nella precedente: sospensione Charlotte White.
This page: Charlotte Orange Suspension; previous page: Charlotte Suspension White.

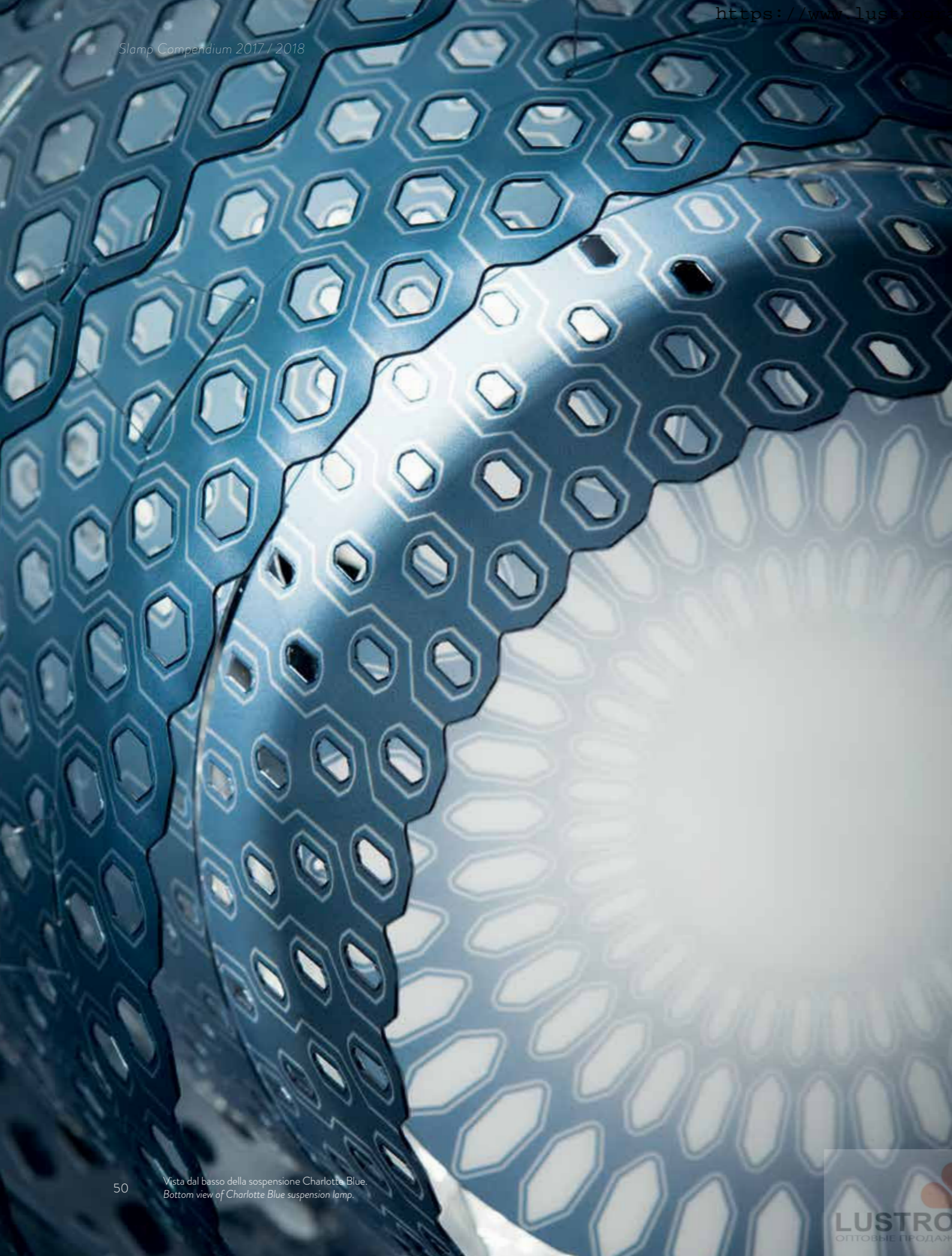

CHARLOTTE FLOOR

FLOOR LAMP

LED: 45W - 220V or 120V
2600 Lumen - 2700 Kelvin
CRI > 90

Triac Dimmable (Trailing Edge min. 20W)

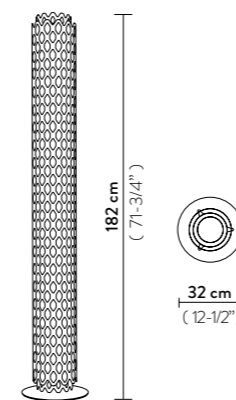

With: Stainless Steel Base
Made of: Cristalflex® / Lentiflex®

Price List: page 12



HALF CHARLOTTE

SUSPENSION

LED: 70W - 220V or 120V
7.000 Lumen - 2700 Kelvin
CRI > 90

Triac Dimmable (Trailing Edge min. 20W)

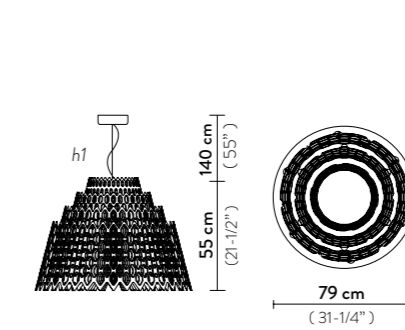

h1: maximum cable length

Made of: Cristalflex® / Lentiflex®

Price List: page 12



CHARLOTTE

SUSPENSION

LED: 140W - 220V or 120V
14.000 Lumen - 2700 Kelvin
CRI > 90

Triac Dimmable (Trailing Edge min. 20W)

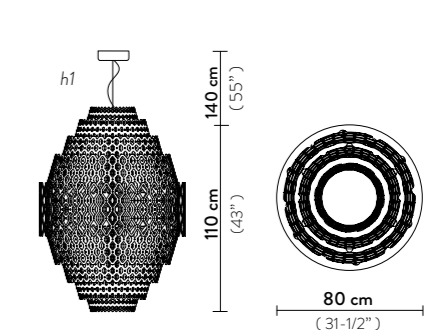

h1: maximum cable length

Made of: Cristalflex® / Lentiflex®

Price List: page 12





CHANTAL

BY DORIANA AND
MASSIMILIANO
FUKSAS

La forma scultorea di Chantal sembra modellarsi da un unico volume, con una trama laboriosa a tratti impalpabile, come quella del nido d'ape, attraverso cui è permesso addentrarsi tramite forme esagonali concentriche e ipnotiche per avere una prospettiva sempre nuova da ogni punto di osservazione. La luce dei LED di Chantal ricorda il rincorrersi delle onde e la trasparenza del momento in cui si assottigliano, si dematerializzano rinviando interminabili gocce luminose.

Chantal's sculptural shape seems to be molded from a singular, industrious frame, much like honeycomb with its impalpable elements. Its concentric, hexagonal shapes allow for unending views. Chantal's LED source resembles waves pulling away from the shore, leaving little illuminated drops behind.





CHANTAL L

SUSPENSION

LED: 105W - 220V or 120V
12.000 Lumen - 2700 Kelvin
CRI 90

Triac Dimmable (Trailing Edge min. 20W)

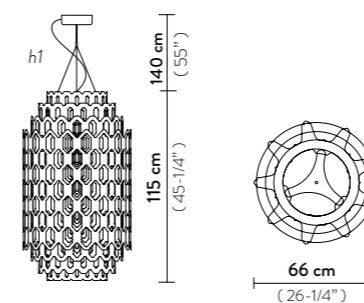

h1: maximum cable length

With: MagneticSystem®
Made of: Cristalflex® / Lentiflex®

CHANTAL M

SUSPENSION

LED: 70W - 220V or 120V
8.000 Lumen - 2700 Kelvin
CRI 90

Triac Dimmable (Trailing Edge min. 20W)

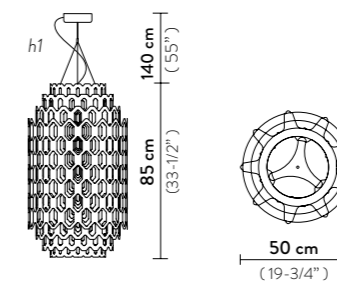

h1: maximum cable length

With: MagneticSystem®
Made of: Cristalflex® / Lentiflex®

CHANTAL S

SUSPENSION

LED: 35W - 220V or 120V
4.000 Lumen - 2700 Kelvin
CRI 90

Triac Dimmable (Trailing Edge min. 20W)

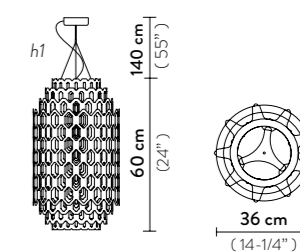

h1: maximum cable length

With: MagneticSystem®
Made of: Cristalflex® / Lentiflex®



Price List: page 16

THE LIGHTNING ARCHIVES OF STUDIO JOB

Con una grammatica iconografica di derivazione dadaista, Studio Job scrive un'ode al Tube - masterpiece di Slamp degli anni '90 - per narrarne la poeticità, l'aura, la storia e l'audacia decorativa. Una collezione di 7 lampade stravaganti, 7 display luminosi, brillanti e dalla forte identità visiva nati dalle sue più creative espressioni surrealiste: Labyrinth, Love Peace Joy, Perished, Peace Skull, Faena Art, Bananas, L'Afrique.

Iconic semantics meet Dadaist derivations in Studio Job's ode to the Tube, bringing a daring poetic aura to the historic Slamp masterpiece, first produced in the early nineties. The collection of 7 extravagant lamps are illuminated by a strong, surrealist identity born of creative expression: Labyrinth, Love Peace Joy, Perished, Peace Skull, Faena Art, Bananas, L'Afrique.







Bananas



Labyrinth



Perished





Peace Skull

Faena Art

L'Afrique





Love Peace Joy



THE LIGHTNING ARCHIVES

FLOOR LAMP

Bulbs: 3 X 8W LED Filament - E27 or E26
Dimmer Included

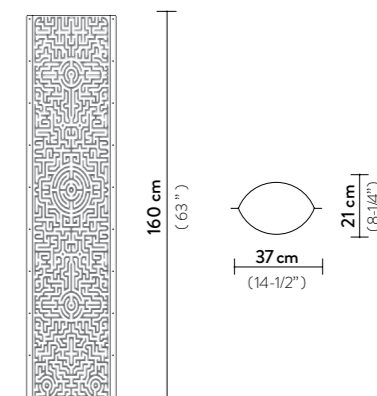

With: Brass / Coloured Finish Profiles

Made of: Opalflex® / Cristalflex®

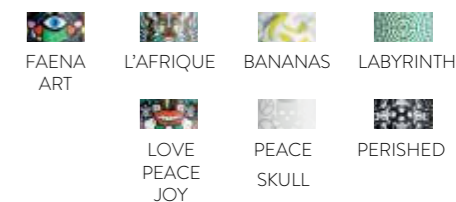

Price List: page 24



CORDOBA BY DANIEL LIBESKIND

Asimmetrie e frammenti all'apparenza disarticolati si sintetizzano in una lampada lontana dai canoni estetici tradizionali e ispirata all'omonima città spagnola, dove architetture e luci dipingono un'atmosfera mistica. Fogli piani di tecnopolimeri brevettati prendono vita da un algoritmo matematico e diffondono in maniera armonica la luce. Cordoba è allestita completamente a mano, offrendo diversi punti di vista a chi la osserva nella sua interezza.

The unique, avant-garde lamp is an asymmetrical series of fragments, seemingly disarticulated, that stray far from traditional aesthetics; the lamp was inspired by the eponymous Spanish city, where architecture and light make for a mystical atmosphere. Flat sheets of our patented techno-polymer material take shape using an algorithm that diffuses the light throughout a seemingly endless structure. Cordoba is handcrafted, and offers varying points of view even when seen in its whole.







CORDOBA

SUSPENSION

LED: 130W - 220VAC or 120VAC / 24Vdc
15.000 Lumen - 2700 Kelvin
CRI > 90

Dimmable with: PWM, 0-10 or Potentiometer

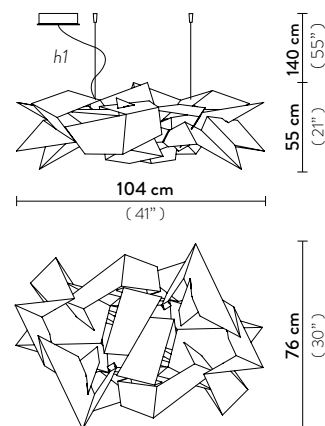

h1: maximum cable length

Made of: Cristalflex®

Price List: page 10

WHITE



DOME BY ANALOGIA PROJECT

Nella forma architettonica di una cupola appare la decorazione romana spesso collegata alla figura mitologica di Medusa: mosaici radiali che incorniciano il volto epico della figlia delle divinità marine. Il pattern si sviluppa su diversi strati che nascondono la fonte luminosa a LED e riflettono la luce attraverso un delicato gioco di colori e trasparenze. Il richiamo tra passato e presente si riflette nel processo di produzione che unisce tecnologie contemporanee a tecniche artigianali, rendendo ogni pezzo unico. Disponibile in due misure e in una vasta gamma cromatica.

Roman adornment connected to the Medusa appears within this architectural dome, with mosaics radiating around the epic face of the sea gods' daughter. The pattern extends over several layers that cover the LED source, reflecting the light through a delicate play of colours and transparencies. The production process unites the latest technology with artisan techniques, marrying the past and the present, and making every piece unique. Dome is available in two sizes and a myriad of chromatic shades.



In questa pagina: Dome Orange; nella precedente: vista dal basso della Dome Orange con dettaglio sulla texture ispirata ai mosaici romani.
This page: Dome Orange; previous page: bottom view of Dome Orange with a close-up of the roman mosaic-inspired texture.





DOMEL

SUSPENSION

LED: 55W - 220Vac or 120Vac / 24Vdc
 4.000 Lumen - 2700 Kelvin
 CRI > 90

Dimmable with: PWM, 0-10 or Potentiometer

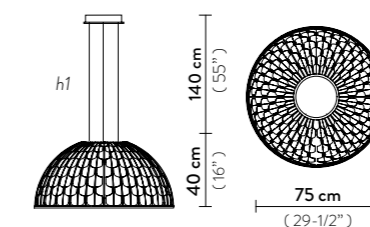

h1: maximum cable length

Made of: Cristalflex®

Price List: page 18

DOME

SUSPENSION

LED: 35W - 220Vac or 120Vac / 24Vdc
 2.500 Lumen - 2700 Kelvin
 CRI > 90

Dimmable with: PWM, 0-10 or Potentiometer

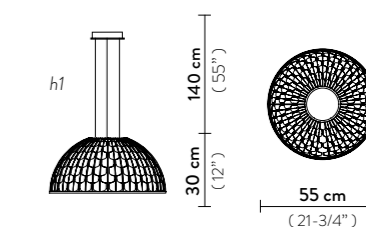

h1: maximum cable length

Made of: Cristalflex®



DRUSA BY ADRIANO RACHELE

Traendo ispirazione dai cristalli incastonati nelle fratture delle rocce che, toccati dalla luce, manifestano un'anima brillante, poetica e multiforme, Drusa ha un segno contemporaneo dove l'asperità degli angoli, disegnati dall'effetto cromatico del Lentiflex® stampato con finitura Velvet, viene smorzata dalla fonte luminosa centrale che conferisce profondità al design, armonizzando luce e forma. Sia in versione plafoniera/applique che a sospensione, che solletica l'immagine di un diamante, Drusa conferisce agli ambienti un sapore fresco e trendy, perfetta per illuminare con carattere in tutte le sue sfumature cromatiche.

Drusa draws inspiration from crystals poking out from crevices in the rocks; they exhibit an ever-changing, poetic and multiform kaleidoscope when hit by the light. The contemporary, chromatic angles accentuated by Lentiflex® finished with a Velvet print, are muted by the central light source, that not only gives depth to the design, but creates harmony between light and shape. Drusa, resembling a diamond, is available in suspension and ceiling versions, and with its infinite chromatic shades, brings a fresh, trendy feel to any space.



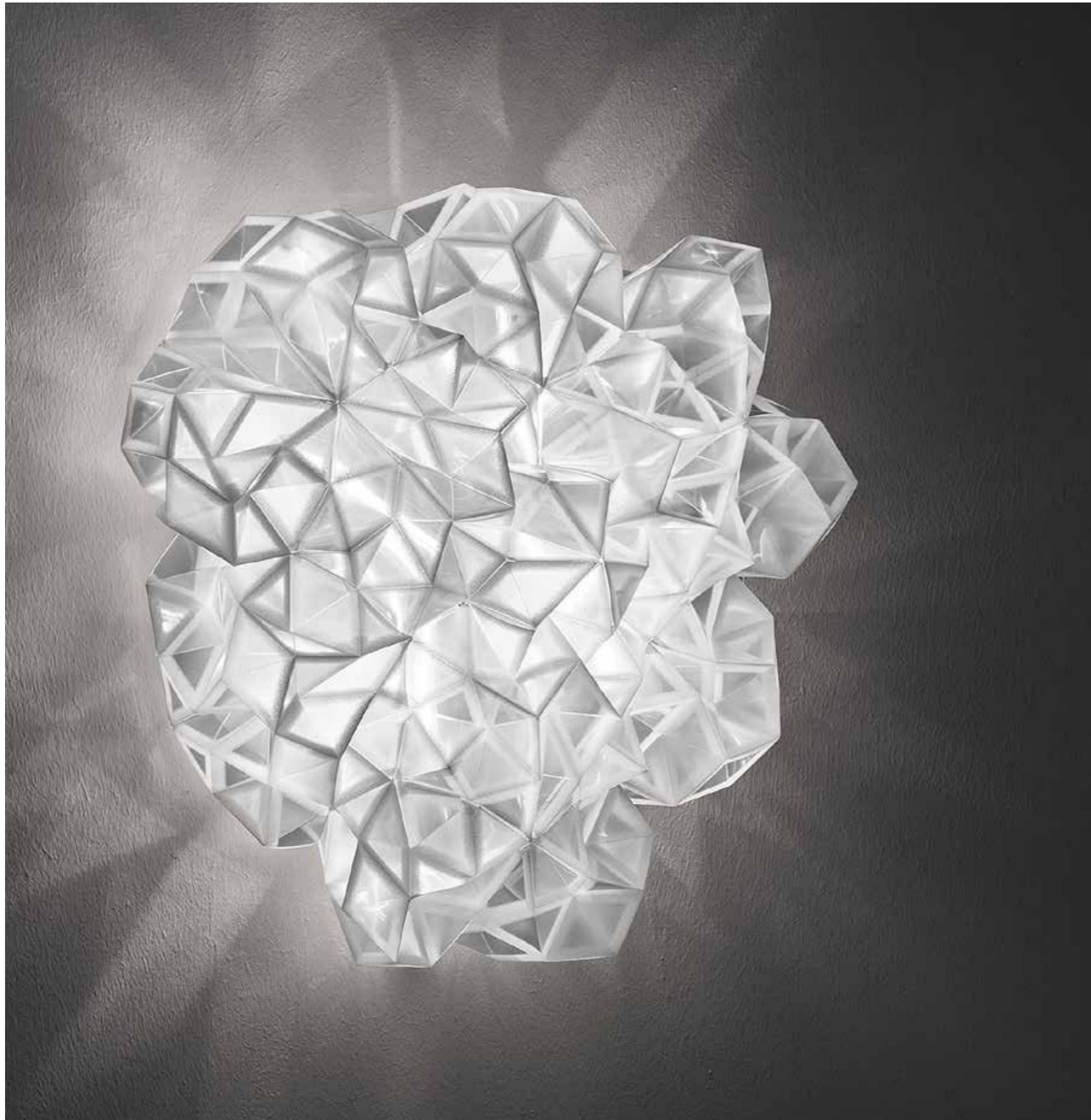







Drusa Velvet



Drusa White



DRUSA

SUSPENSION

Bulbs: 4X 8W LED Filament - E27 or E26

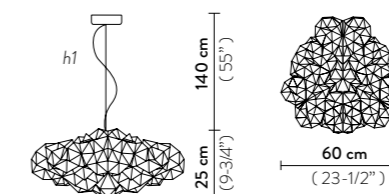

h1: maximum cable length

With: MagneticSystem®

Made of: Lentiflex®

Price List: page 22

CEILING / WALL LAMP

Bulbs: 4X 8W LED Filament - E27 or E26

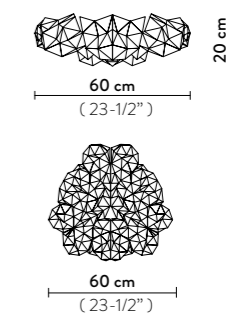

With: MagneticSystem®

Made of: Lentiflex®



LIZA PEWTER

BY ELISA GIOVANNONI

Mastepiece della collezione Liza è l'iconica lampada da tavolo d'ispirazione barocca che unisce un design dal sapore tradizionale all'uso dei tecnopolimeri brevettati di Slamp. Con un sistema di doppia illuminazione - LED di cortesia nella base e lampada nel cappello - Liza si trasforma a ogni accensione in un proiettore di luci e ombre. Completano la collezione la versione da terra con asta snodabile e la sospensione con sottili tagli verticali.

The masterpiece of the Liza collection is the iconic, baroque-inspired table lamp, available in the classic Prisma version, as well as a new Pewter version, both using Slamp's patented techno-polymer materials. Liza has a double illumination system, with a courtesy LED in the base and bulb in the principle pleated shade, creating contrasts of light and shadows that give depth and warmth to any space. The collection also includes a floor version with an adjustable arm and a suspension with subtle, vertical incisions.





LIZA PEWTER

TABLE LAMP

Hat Bulb: 1X8W LED Filament - E27 or E26

Base LED: 1,5W - 220V or 120V
100 Lumen - 2700 Kelvin

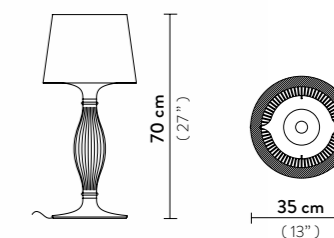

With: Two positions light switch
Courtesy base LED

Made of: Lentiflex® / Pewterflex® / Polycarbonate

Price List: page 40



PEWTER



LIZA
BY ELISA
GIOVANNONI



In questa pagina: dettaglio della base in policarbonato e della struttura plissettata realizzata in Lentiflex®. Nella pagina precedente: Liza Prisma.

This page: close-up of the polycarbonate base and of the folded Lentiflex® structure
Previous page: Liza Prisma.

LIZA

TABLE LAMP

Hat Bulb: 1X 8W LED Filament - E27 or E26

Base LED: 1,5W - 220V or 120V
100 Lumen - 2700 Kelvin

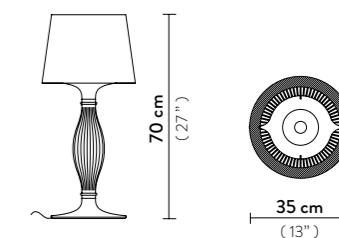

With: Two positions light switch
Courtesy base LED

Made of: Lentiflex® / Pewterflex® / Polycarbonate

Price List: page 40





Liza spenta
Liza Switched Off

LED di cortesia della base acceso
Base courtesy LED switched on

Luce del cappello e LED di cortesia
della base entrambi accesi
Shade bulb and base courtesy
LED switched on

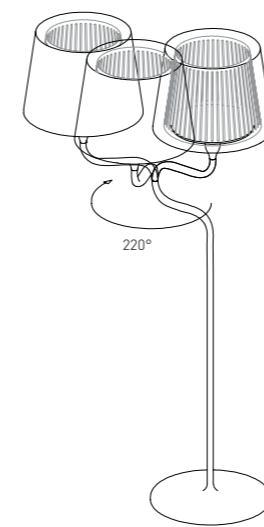

220° SHADE ROTATION

LIZA

FLOOR LAMP

Bulbs: 1X8W LED Filament - E27 or E26

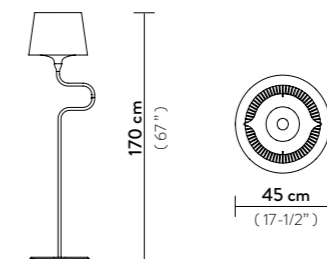

With: Steel Base and Stem
Made of: Lentiflex® / Polycarbonate

SUSPENSION

Bulbs: 1X8W LED Filament - E27 or E26

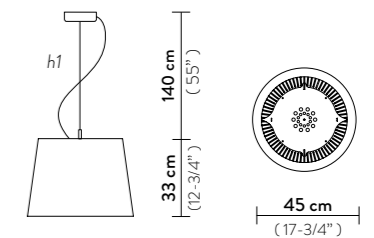

h1: maximum cable length

With: Push-Pull System®
Made of: Lentiflex® / Polycarbonate

Price List: page 40





LA LOLLO XL BY LORENZA BOZZOLI

Tributo ai meravigliosi anni '50, La Lollo è un sistema di sospensioni dal tratto aggraziato che risveglia nell'immaginario una storia di dive e riflettori. La serie di cilindri di tecnopolimeri brevettati si dispone intorno a un anello luminoso centrale alternando colorazioni prismatiche, metallizzazioni, merletti, gradienti cromatici contemporanei e disegni geometrici. La collezione comprende 2 diverse dimensioni, più una opulenta versione a chandelier, progettate per arredare spazi recettivi, domestici o per creare installazioni scenografiche.

La Lollo is a tribute to the roaring 50's, a series of graceful suspensions that reawaken images of divas in the spotlight. The patented techno-polymer cylinders, in varying shades of contemporary prismatic metallization and geometric patterns, alternate around a central, illuminated ring. The collection includes 2 sizes, as well as an opulent chandelier. all designed for public or domestic spaces, or to be combined in dramatic installations.



In questa pagina: La Lollo XL Lace.
This page: La Lollo XL Lace.





La Lollo XL
Mackintosh



La Lollo XL
Gradient



La Lollo XL
Lace



La Lollo XL
Pewter/White



La Lollo XL
Gold/Fumé



LA LOLLO XL

SUSPENSION

LED: 100W - 220Vac or 120Vac / 24Vdc
9.000 Lumen - 2700 Kelvin
CRI > 90

Dimmable with: PWM, 0-10 or Potentiometer

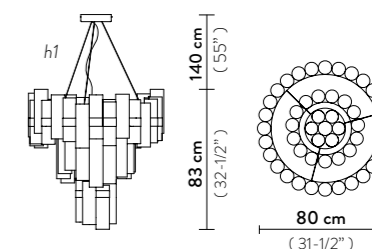

h1: maximum cable length

Made of: Cristalflex® / Lentiflex®
/ Goldflex® / Pewterflex®



Price List: page 26



LA LOLLO L

BY LORENZA BOZZOLI

La Lollo L
Mackintosh



La Lollo L
Gradient



La Lollo L
Lace



La Lollo L
Pewter/White



La Lollo L
Gold/Fumé



LA LOLLO L

SUSPENSION

LED: 56W - 220Vac or 120Vac / 24Vdc
5.000 Lumen - 2700 Kelvin
CRI > 90

Dimmable with: PWM, 0-10 or Potentiometer

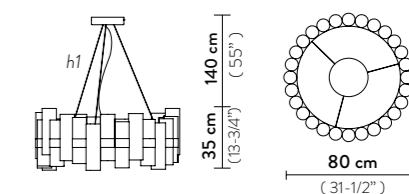

h1: maximum cable length

Made of: Cristalflex® / Lentiflex®
/ Goldflex® / Pewterflex®



Price List: page 26



LA LOLLO M

BY LORENZA BOZZOLI

La Lollo M
Mackintosh



La Lollo M
Gradient



La Lollo M
Lace



La Lollo M
Pewter/White



La Lollo M
Gold/Fumé



LA LOLLO M

SUSPENSION

LED: 28W - 220Vac or 120Vac / 24Vdc
2.500 Lumen - 2700 Kelvin
CRI > 90

Dimmable with: PWM, 0-10 or Potentiometer

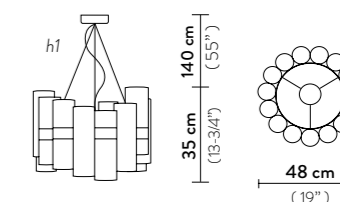

h1: maximum cable length

Made of: Cristalflex® / Lentiflex®
/ Goldflex® / Pewterflex®



Price List: page 26

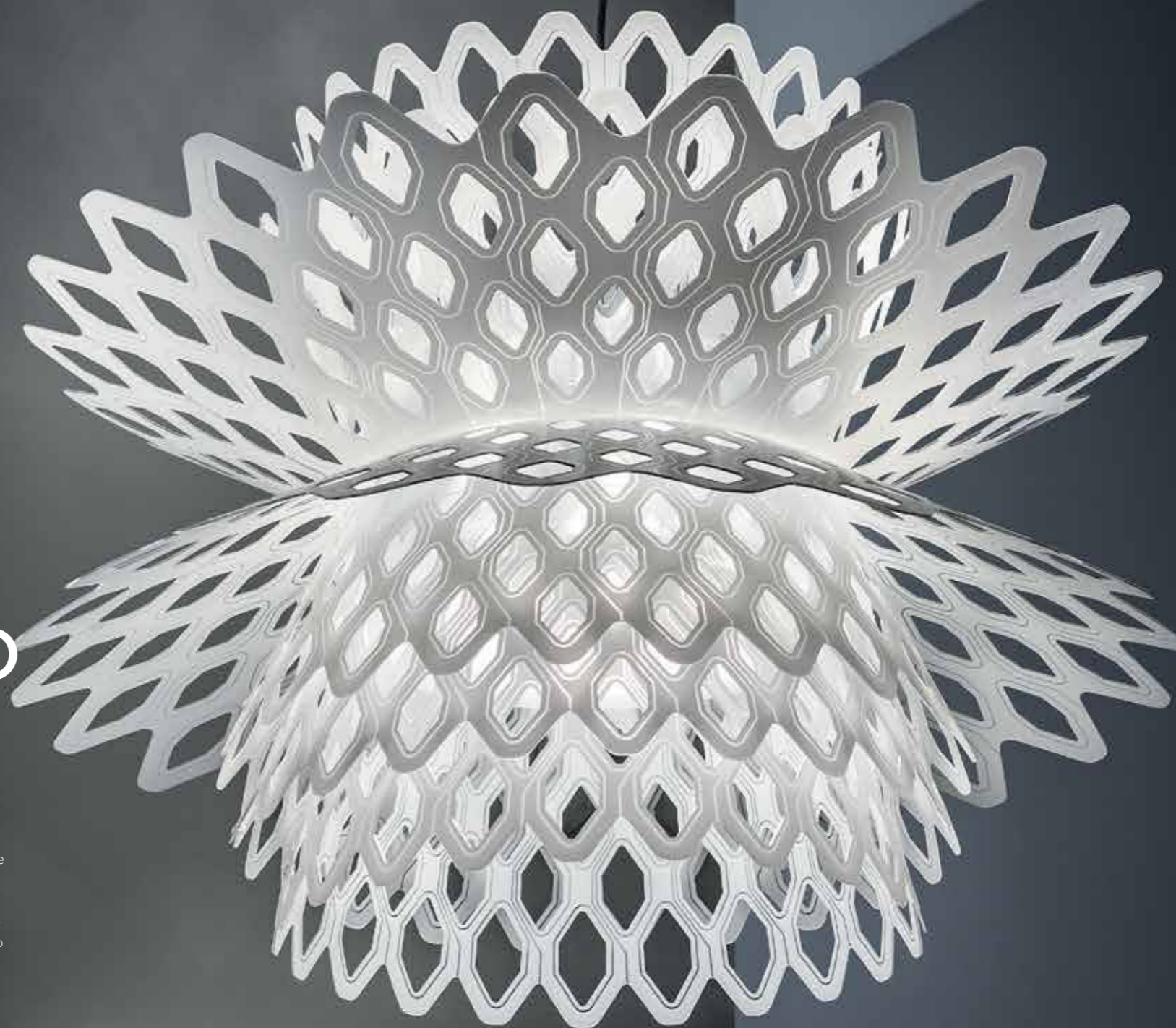

DESERT ROSE BY DORIANA AND MASSIMILIANO FUKSAS

Un fiore di pietra selvaggio e delicato, celato tra le dune di sabbia dorata, un'esplosione di volumi leggeri, stratificazioni che formano trame complesse e suggeriscono mondi lontani. La luce rivela il ritmo delle geometrie, che partendo da un materiale bidimensionale si trasformano in un volume complesso dove l'eterea proporzione tra le parti rievoca le costanti e infinite vibrazioni delle onde di calore del deserto, avvolgendo con questo movimento di luce lo spazio circostante.

A floral stone, wild yet delicate, nestled between golden sand dunes. An explosion of weightless forms, complexly stratified, evoking faraway lands. The light only enhances the rhythm of the lamp's geometries, begun with a two-dimensional sheet transformed into ethereal shapes and proportions that conjure the infinite, constant vibrations of desert heat. The light's movement envelopes its surroundings.



In questa pagina: Desert Rose White; nella successiva: vista dal basso di Desert Rose White.
This page: Desert Rose white; next page: bottom view of Desert Rose White.

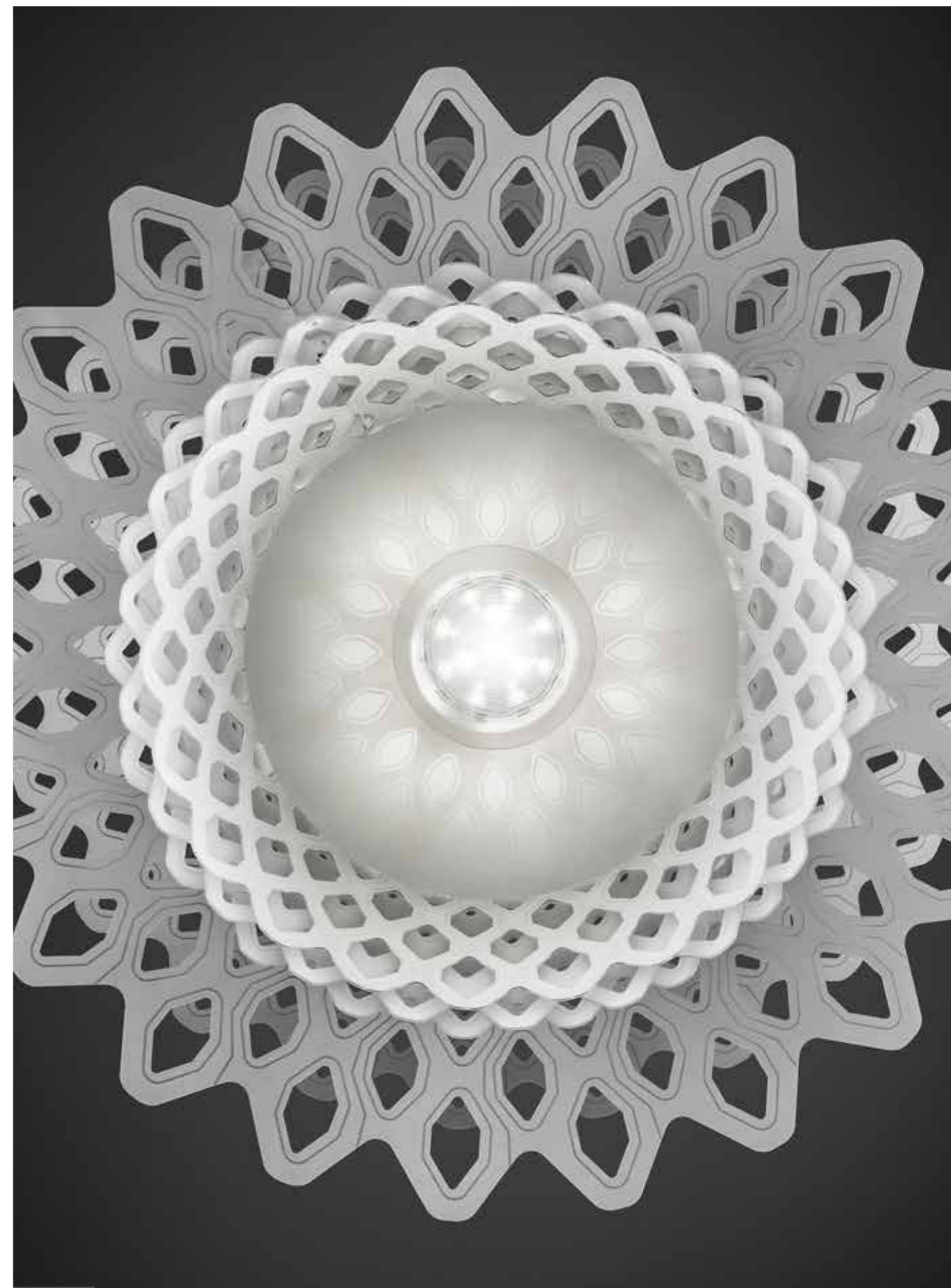



DESERT ROSE

SUSPENSION

LED: 35W - 220V or 120V
3.500 Lumen - 2700 Kelvin
CRI 90

Triac Dimmable (Trailing Edge min. 20W)

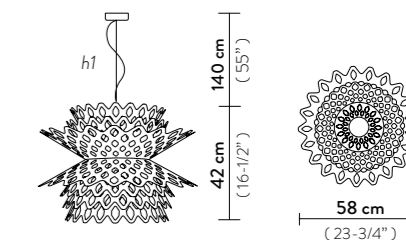

h1: maximum cable length

Made of: Cristalflex® / Lentiflex®

Price List: page 15

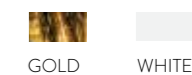

In questa pagina: Desert Rose Gold; nella successiva dall'alto: vista dal basso e particolare della texture esagonale di Desert Rose Gold.
This page: Desert Rose Gold; next page: bottom view and close-up of Desert Rose Gold's hexagonal shapes.

HANAMI BY ADRIANO RACHELE

Simbolo di un'esistenza delicata e poetica, Hanami - letteralmente "osservare i fiori" - trova ispirazione nella tradizionale cerimonia giapponese del godere della fioritura dei ciliegi. Dal leggero e rigoglioso lampadario a sospensione in due misure, sino alla versione ceiling, Hanami offre con versatilità un'illuminazione unica dai colori delicati, distribuendo i suoi fiori plissettati a mano in Lentiflex® - materiale nobile che permette di ricreare i riflessi di un diamante - su una struttura in acciaio e policarbonato che custodisce le fonti luminose a LED.

Hanami is a symbol of delicate poetry, taking its name from the traditional Japanese ritual of observing blossoming cherry trees. The Hanami family includes ethereal suspensions, available in two sizes, as well as an applique version that redefines the traditional ceiling lamp concept. Hanami's unique, delicately coloured illumination is distributed throughout hand-folded flowers made of Lentiflex®, a noble material that recreates diamond-like reflections, mounted on a painted steel and polycarbonate frame that houses its LED sources.

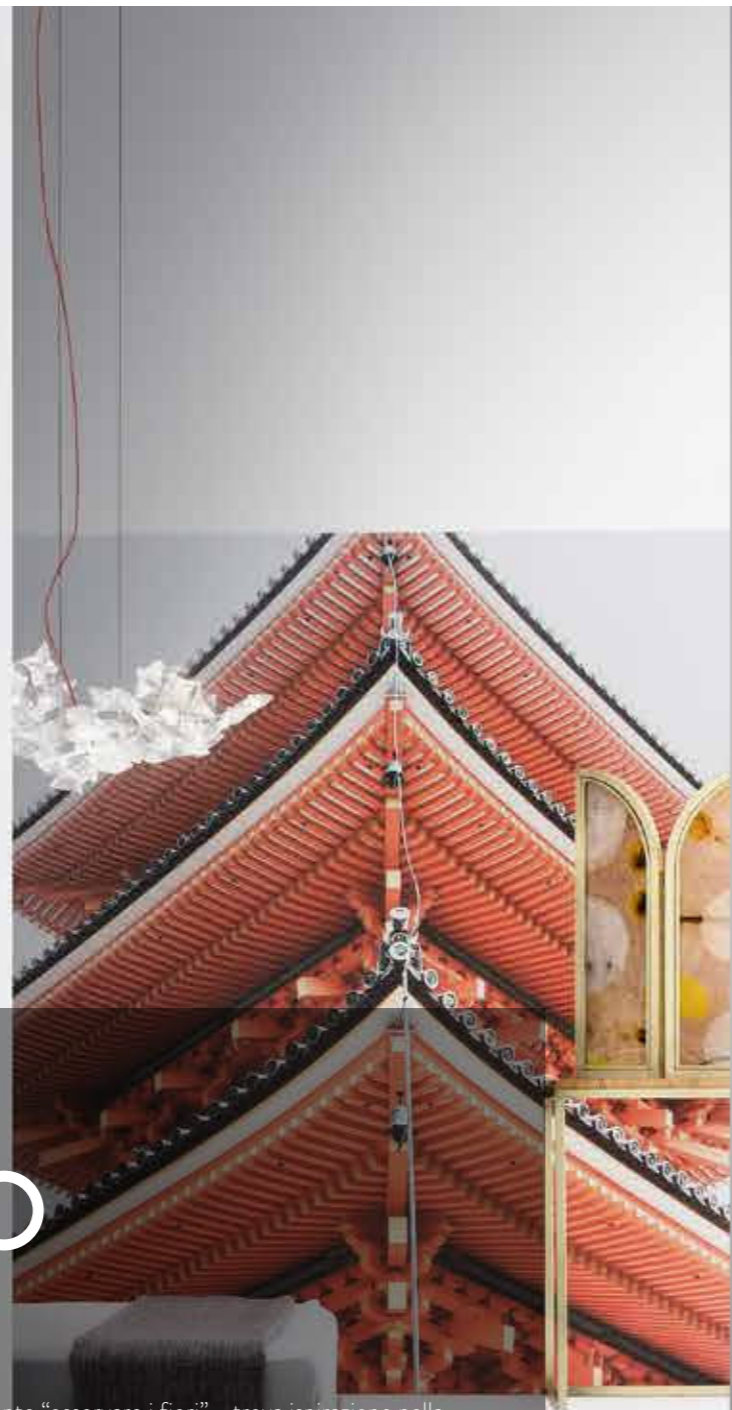





With 103 handmade flowers



With 50 handmade flowers

In questa pagina, dall'alto, Hanami Suspension e Hanami Suspension L, nella pagina precedente: dettaglio dei fiori di Hanami piagati a mano e realizzati in Lentiflex®.

This page, from the top: Hanami Suspension and Hanami Suspension L, previous page: close-up of Hanami's flowers made of Lentiflex® and folded by hand.

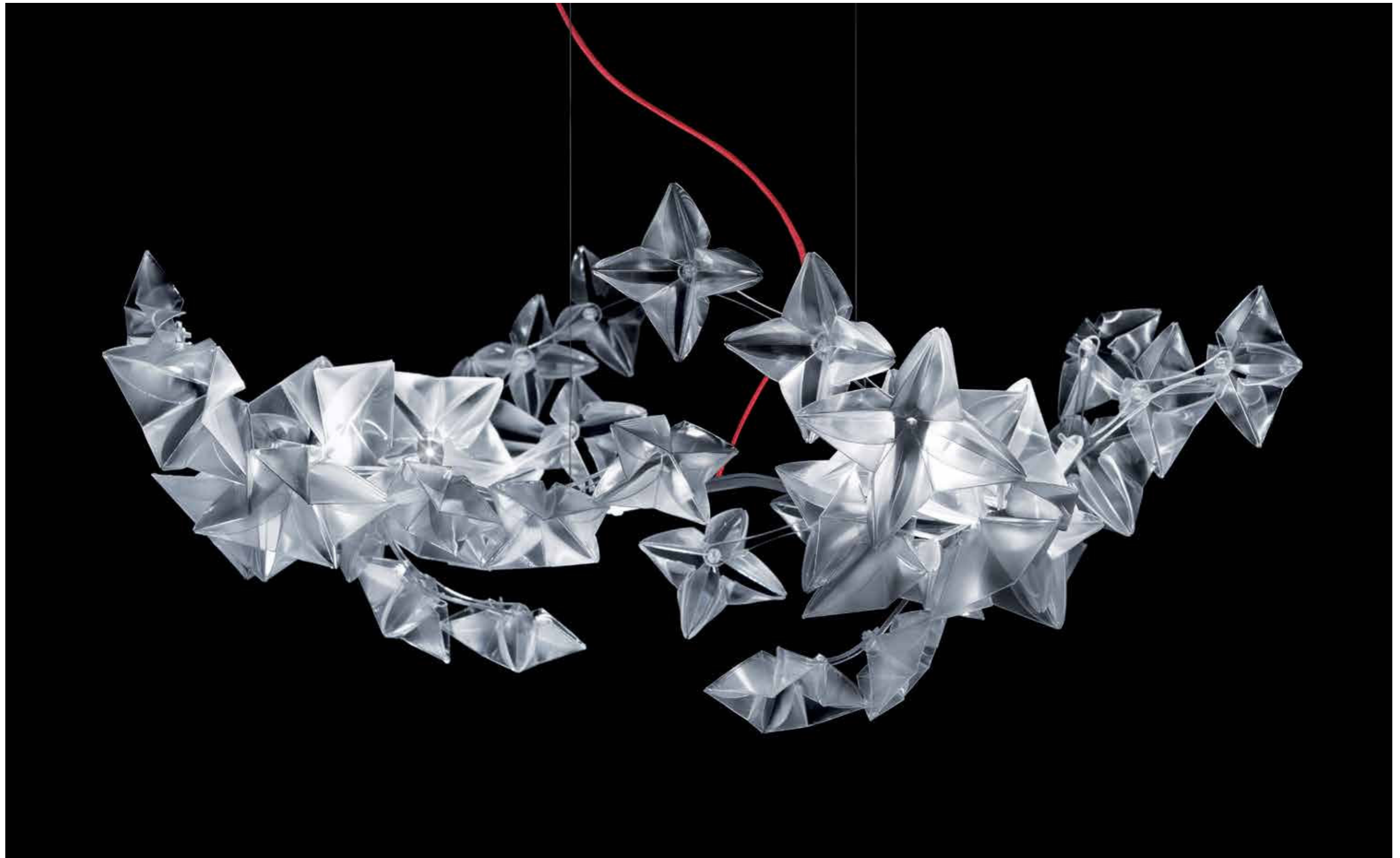



HANAMI L

SUSPENSION

LED: 60W - 220Vac or 120Vac / 36Vdc
5.000 Lumen - 2700 Kelvin
CRI 90

Triac Dimmable (Trailing Edge min. 20W)

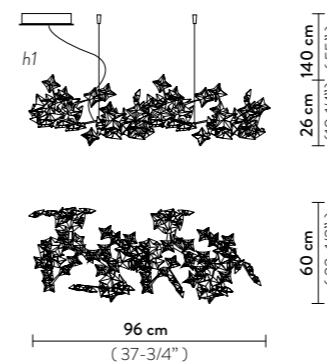

h1: maximum cable length

With: Red Wrapped Cable
Made of: Lentiflex®

HANAMI

SUSPENSION

LED: 25W - 220Vac or 120Vac / 36Vdc
2.500 Lumen - 2700 Kelvin
CRI 90

Triac Dimmable (Trailing Edge min. 20W)

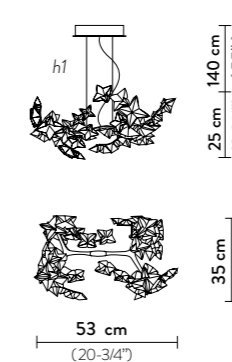

h1: maximum cable length

With: Red Wrapped Cable
Made of: Lentiflex®

HANAMI

CEILING / WALL LAMP

LED: 35W - 220Vac or 120Vac / 36Vdc
3.500 Lumen - 2700 Kelvin
CRI 90

Triac Dimmable (Trailing Edge min. 20W)



Made of: Lentiflex®

Price List: page 20





FLORA

BY ZANINI DE ZANINE

In una terra baciata dal sole, dove natura, maestria artigiana e colori danno vita a segni altamente espressivi e densi di archetipi, nasce Flora, collezione ispirata alla pianta Monstera Deliciosa. 60 petali avvolgono la sfera satinata, cuore lucente della lampada disponibile sia in versione a sospensione, che nella versione da terra dotata di sottili steli che ricordano i pistilli di un fiore. Le finiture lucide dei petali, sono realizzate con un innovativo sistema di vaporizzazione di alluminio per creare un suggestivo gioco di riflessi rubato all'effetto del sole allo zenith.

In a land kissed by the sun, nature, colours and artisan expertise bring life to highly expressive pieces dense with archetypes, including Flora, the collection inspired by the Monstera Deliciosa plant. Sixty petals surround a satin sphere illuminated from its core. The lamp is available both as a suspension version, as well as a ground version resting on thin legs that resemble a flower's pistils. The petals' shiny finish, to which we have added gun-metal grey, is achieved through an innovative aluminum vapourization system that creates an evocative play on light, seemingly stolen from the sun at its zenith.







FLORA

FLOOR LAMP

Bulbs: 3X8W LED Filament - E27 or E26

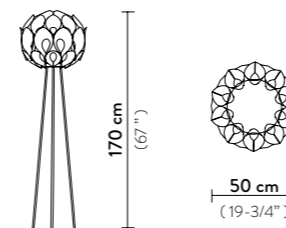

With: MagneticSystem® - Dimmer included
Hand-finished Sphere

Made of: Goldflex® or Steelflex® or Copperflex® or Pewterflex®

Price List: page 46

FLORA M

SUSPENSION

Bulbs: 3X8W LED Filament - E27 or E26

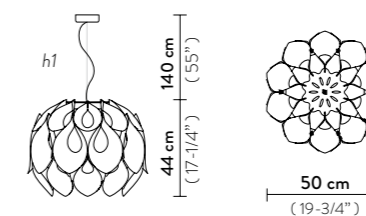

h1: maximum cable length

With: MagneticSystem®
Hand-finished Sphere

Made of: Goldflex® or Steelflex® or Copperflex® or Lentiflex® or Pewterflex®

FLORA S

SUSPENSION

Bulbs: 1X8W LED Filament - E27 or E26

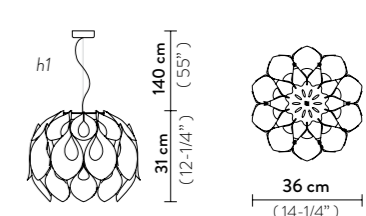

h1: maximum cable length

With: MagneticSystem®
Hand-finished Sphere

Made of: Goldflex® or Steelflex® or Copperflex® or Lentiflex® or Pewterflex®

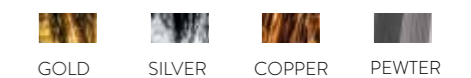



FLORA M

SUSPENSION

Bulbs: 3X8W LED Filament - E27 or E26

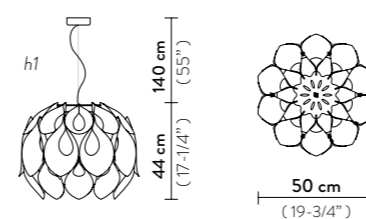

h1: maximum cable length

With: MagneticSystem®
Handicraft-finished Sphere

Made of: Goldflex® or Steelflex® or Copperflex®
or Lentiflex® / Methacrilate Sphere

FLORA S

SUSPENSION

Bulbs: 1X8W LED Filament - E27 or E26

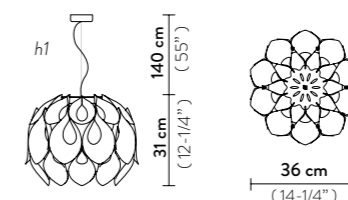

h1: maximum cable length

With: MagneticSystem®
Handicraft-finished Sphere

Made of: Goldflex® or Steelflex® or Copperflex®
or Lentiflex® / Methacrilate Sphere

FLORA TRIPLE

SUSPENSION

Bulbs: 3X4W LED Filament - E14 or E12

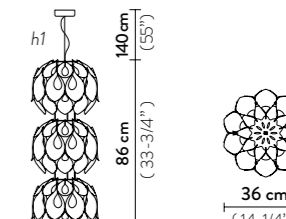

h1: maximum cable length

With: MagneticSystem®
Handicraft-finished Sphere

Made of: Lentiflex® / Methacrilate Sphere

Price List: page 46





VELI COUTURE BY ADRIANO RACHELE

Con una inedita finitura ispirata alle texture tessili contemporanee, che esaltano la morbidezza del suo segno, Veli Couture è perfetta per assicurare agli ambienti una luce calda unitamente all'estetica e al decoro rigoglioso che la contraddistinguono. Il cavo rosso calzato accresce il sapore contemporaneo delle sospensioni, che traggono ispirazione dal mondo dell'haute couture e sono allestite interamente a mano.

A soft finish that was inspired by modern fabric textures. Veli Couture fills and envelops any space, setting it apart with its aesthetics and lush decorative characteristics. The suspension's red, wrapped cable increases the handmade lamps' modernity, taking a cue from the world of haute couture.



In primo piano: Veli Couture Suspension Large, in secondo piano Veli Couture Suspension Small.
Foreground: Veli Couture Suspension Large; background: Veli Couture Suspension Small.

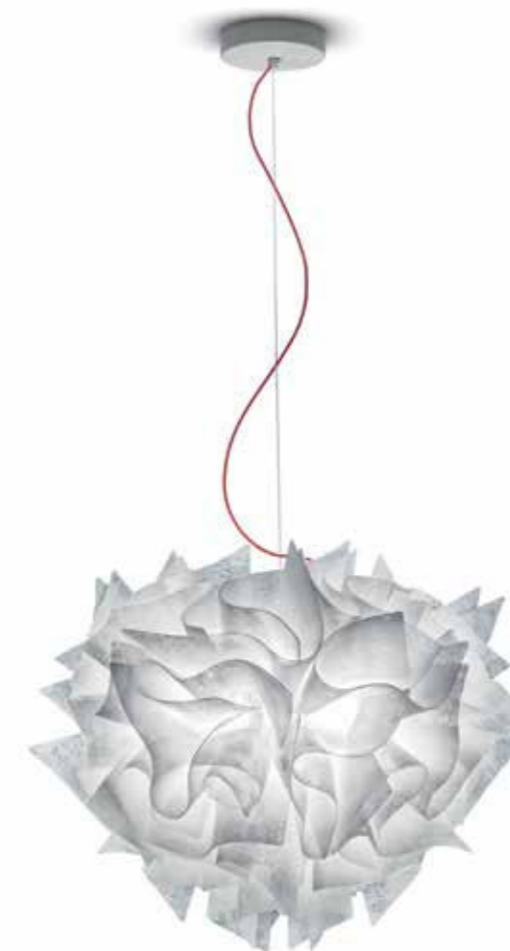

VELI L COUTURE

SUSPENSION

Bulbs: 4X8W LED Filament - E27 or E26

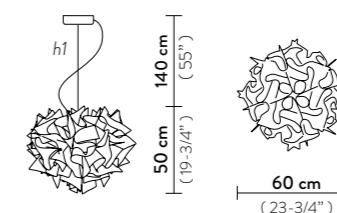

h1: maximum cable length

With: MagneticSystem®

Made of: Opalflex®

Price List: page 50

VELI M COUTURE

SUSPENSION

Bulbs: 2X8W LED Filament - E27 or E26

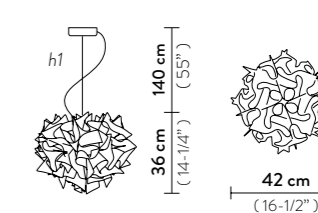

h1: maximum cable length

With: MagneticSystem®

Made of: Opalflex®

TEXTURIZED
WHITE

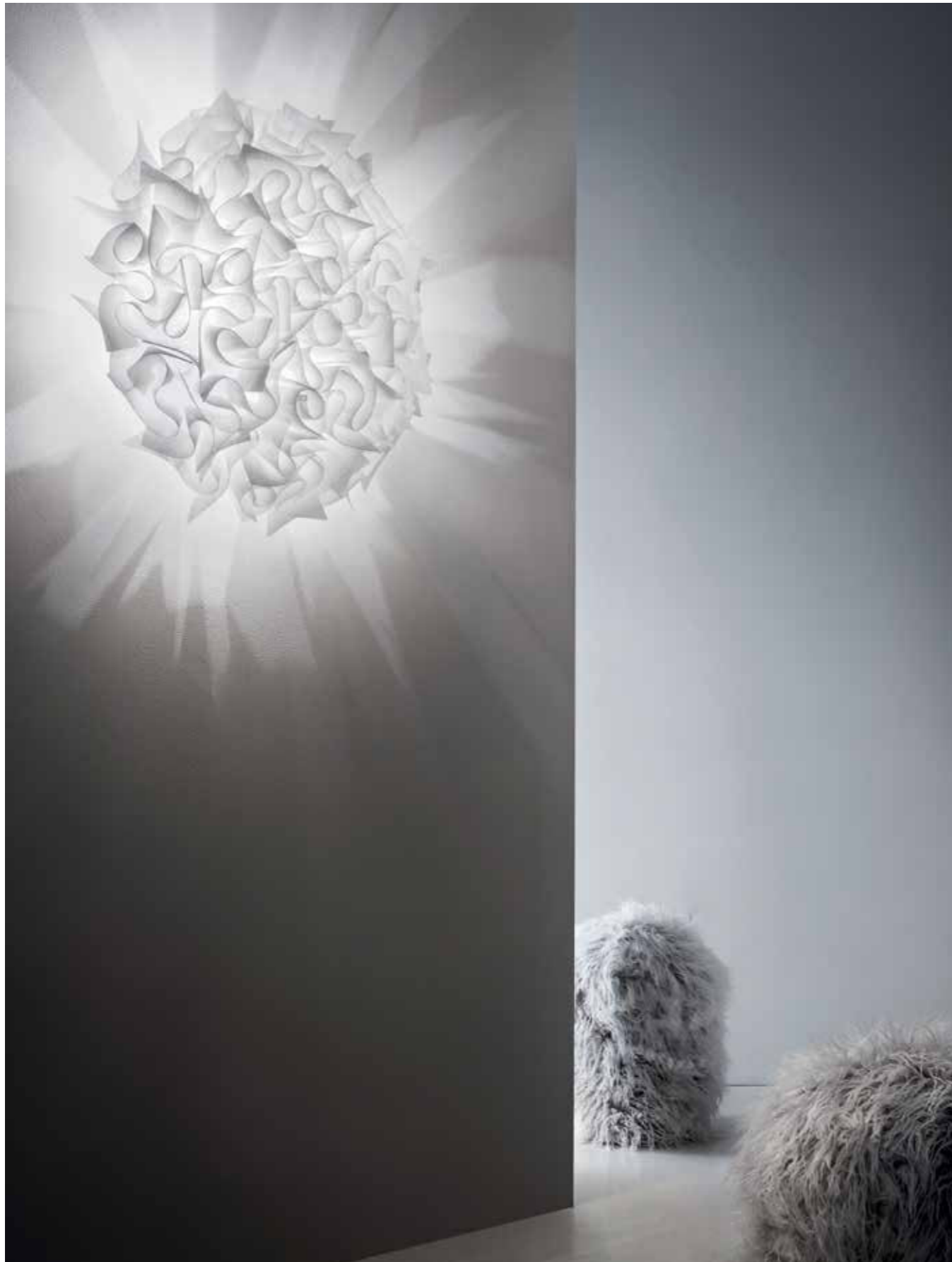

VELI L COUTURE

CEILING / WALL LAMP

Bulbs: 3 X 8W LED Filament - E27 or E26

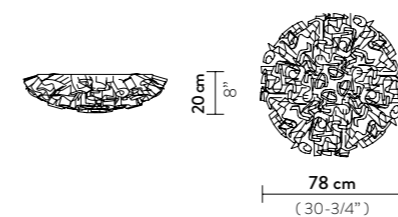

With: MagneticSystem®
Made of: Opalflex®



VELI M COUTURE

CEILING / WALL LAMP

Bulbs: 2 X 8W LED Filament - E27 or E26

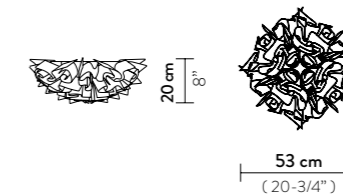

With: MagneticSystem®
Made of: Opalflex®



VELI MINI COUTURE

CEILING / WALL LAMP

Bulbs: 1 X 4W LED Filament - E14 or E12

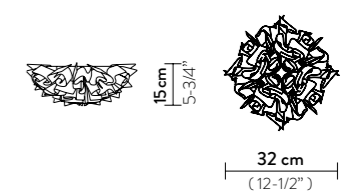

With: MagneticSystem®
Made of: Opalflex®

Price List: page 50

TEXTURIXED
WHITE



VELI TABLE Ø32 COUTURE

TABLE LAMP

Bulbs: 1X4W LED Filament - E14 or E12

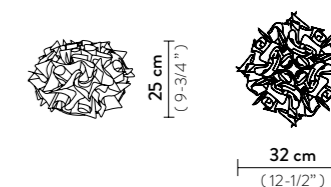

With: MagneticSystem®

Made of: Opalflex® / Metacrylate base

Price List: page 50



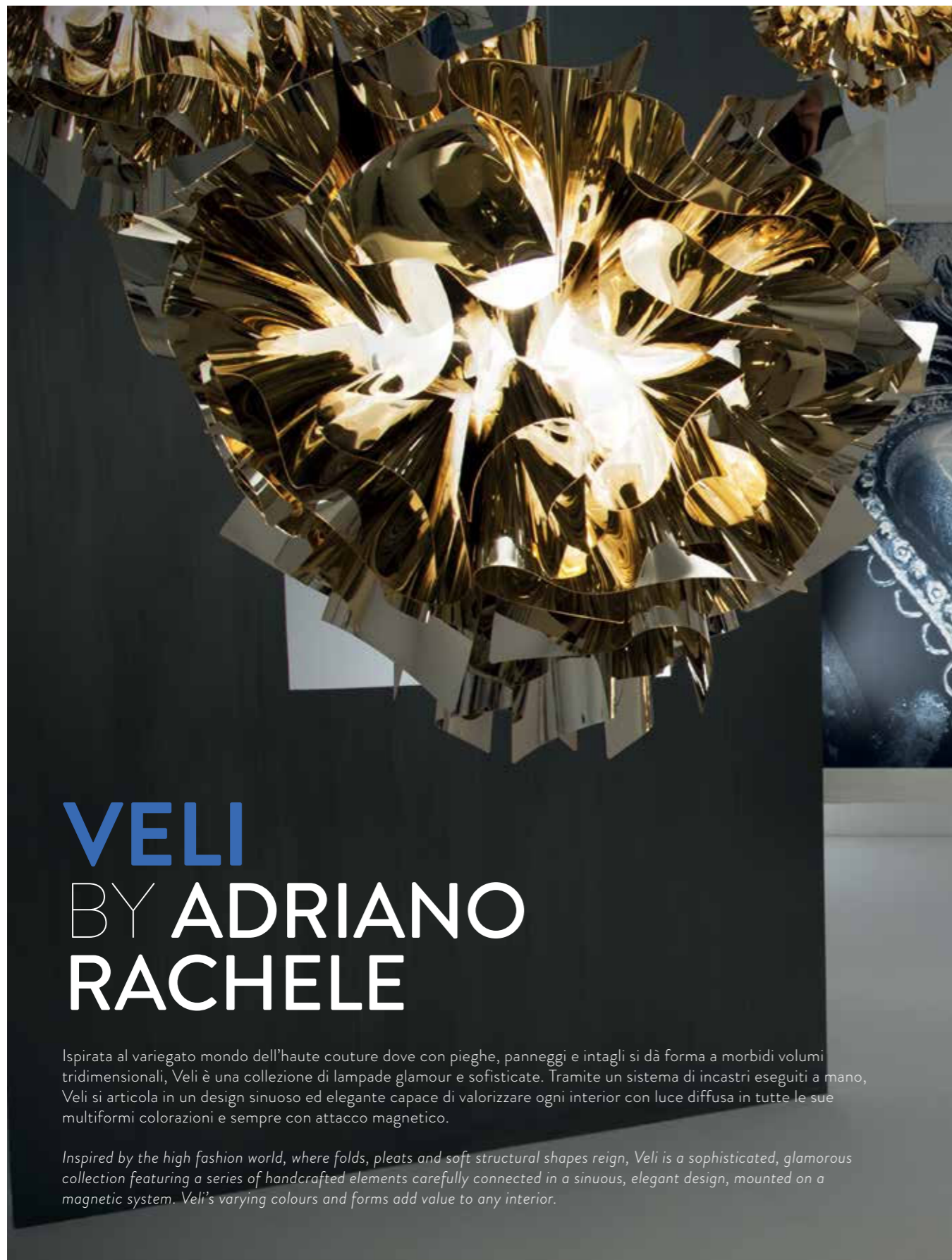

VELI BY ADRIANO RACHELE

Ispirata al variegato mondo dell'haute couture dove con pieghe, panneggi e intagli si dà forma a morbidi volumi tridimensionali, Veli è una collezione di lampade glamour e sofisticate. Tramite un sistema di incastri eseguiti a mano, Veli si articola in un design sinuoso ed elegante capace di valorizzare ogni interior con luce diffusa in tutte le sue multiformi colorazioni e sempre con attacco magnetico.

Inspired by the high fashion world, where folds, pleats and soft structural shapes reign, Veli is a sophisticated, glamorous collection featuring a series of handcrafted elements carefully connected in a sinuous, elegant design, mounted on a magnetic system. Veli's varying colours and forms add value to any interior.





VELI L
GOLD, SILVER AND COPPER

SUSPENSION

Bulbs: 4 X 8W LED Filament - E27 or E26

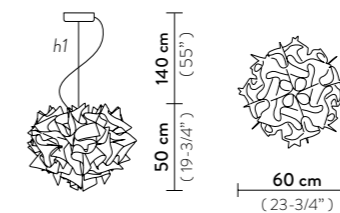

h1: maximum cable length

With: MagneticSystem®
Made of: Goldflex® or Steelflex® or Copperflex®

Price List: page 50

VELI M
GOLD, SILVER AND COPPER

SUSPENSION

Bulbs: 2 X 8W LED Filament - E27 or E26

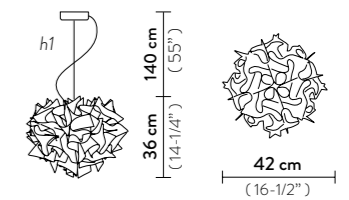

h1: maximum cable length

With: MagneticSystem®
Made of: Goldflex® or Steelflex® or Copperflex®





VELI L
GOLD, SILVER AND COPPER

CEILING / WALL LAMP

Bulbs: 3 X 8W LED Filament - E27 or E26

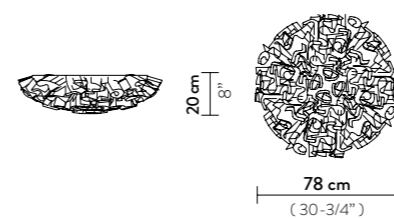

With: MagneticSystem®
Made of: Goldflex® or Steelflex® or Copperflex®

Price List: page 50

VELI M
GOLD, SILVER AND COPPER

CEILING / WALL LAMP

Bulbs: 2 X 8W LED Filament - E27 or E26

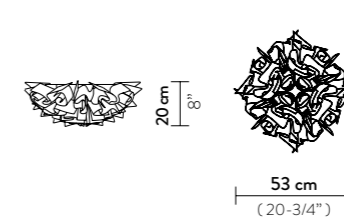

With: MagneticSystem®
Made of: Goldflex® or Steelflex® or Copperflex®

VELI MINI
GOLD, SILVER AND COPPER

CEILING / WALL LAMP

Bulbs: 1 X 4W LED Filament - E14 or E12

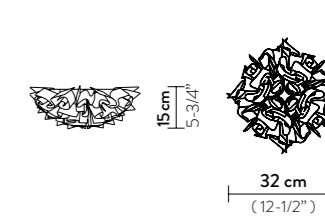

With: MagneticSystem®
Made of: Goldflex® or Steelflex® or Copperflex®



Veli Silver detail



Veli Gold detail



Veli Copper detail



VELI L PRISMA

CEILING / WALL LAMP

Bulbs: 3 X 8W LED Filament - E27 or E26

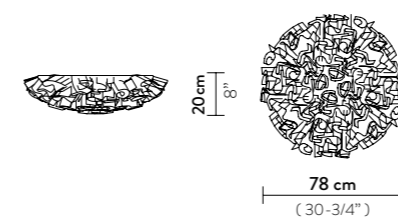

With: MagneticSystem®
Made of: Opalflex®

Price List: page 50

VELI M PRISMA

CEILING / WALL LAMP

Bulbs: 2 X 8W LED Filament - E27 or E26

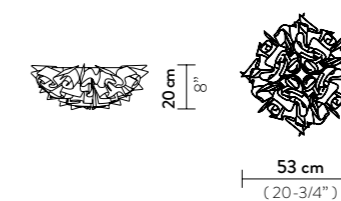

With: MagneticSystem®
Made of: Opalflex®

VELI MINI PRISMA

CEILING / WALL LAMP

Bulbs: 1 X 4W LED Filament - E14 or E12

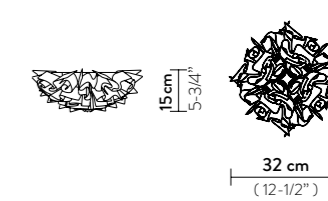

With: MagneticSystem®
Made of: Opalflex®



PRISMA



VELI L PRISMA

SUSPENSION

Bulbs: 4X8W LED Filament - E27 or E26

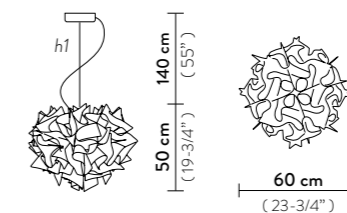

h1: maximum cable length

With: MagneticSystem®

Made of: Lentiflex®

VELI M PRISMA

SUSPENSION

Bulbs: 2X8W LED Filament - E27 or E26

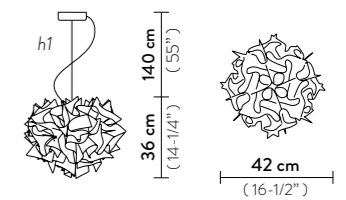

h1: maximum cable length

With: MagneticSystem®

Made of: Lentiflex®

Price List: page 50



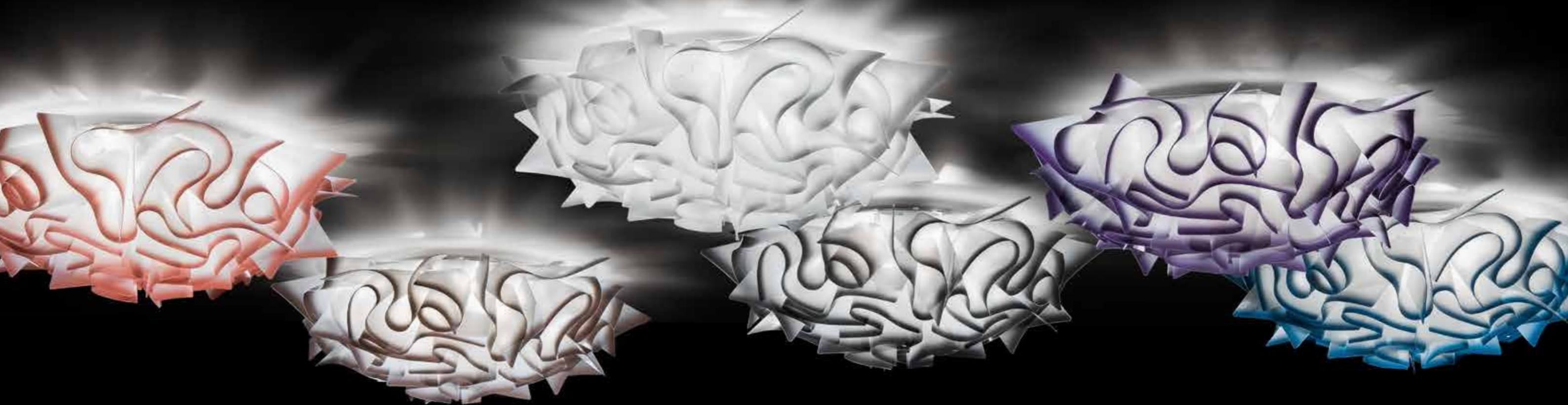

VELI L

CEILING / WALL LAMP

Bulbs: 3X8W LED Filament - E27 or E26

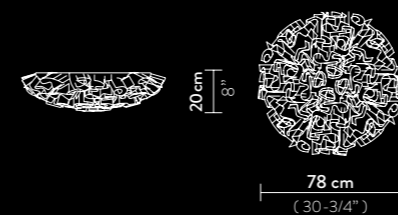

With: MagneticSystem®
Made of: Opalflex®

Price List: page 50



VELI M

CEILING / WALL LAMP

Bulbs: 2X8W LED Filament - E27 or E26

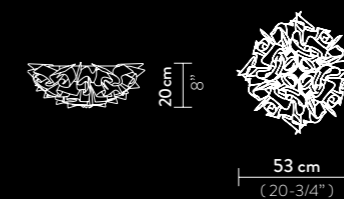

With: MagneticSystem®
Made of: Opalflex®



VELI MINI

CEILING / WALL LAMP

Bulbs: 1X4W LED Filament - E14 or E12



With: MagneticSystem®
Made of: Opalflex®



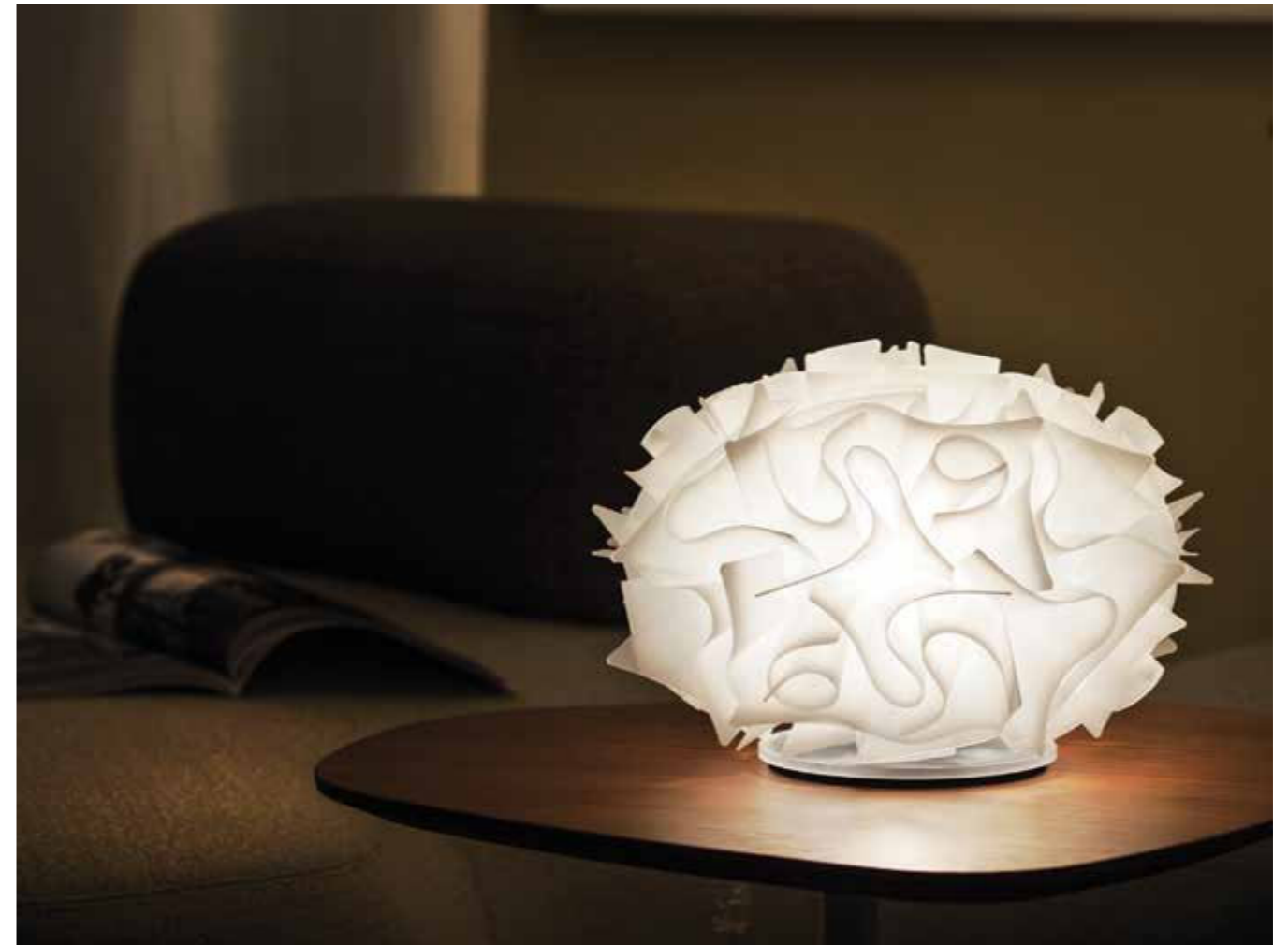
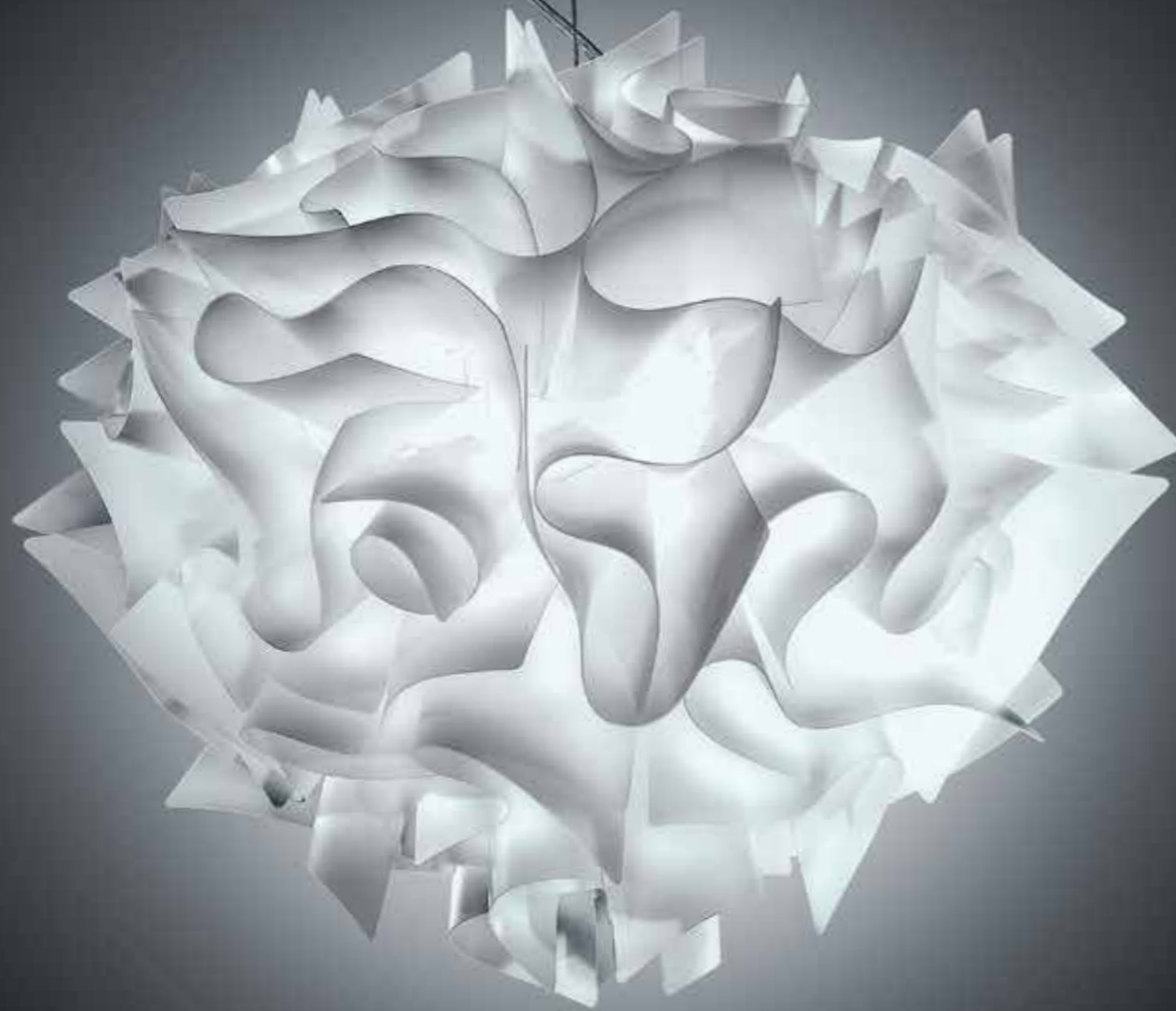

VELI L

SUSPENSION

Bulbs: 4 X 8W LED Filament - E27 or E26

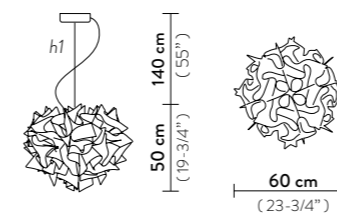

h1: maximum cable length

With: MagneticSystem®
Made of: Opalflex®

VELI M

SUSPENSION

Bulbs: 2 X 8W LED Filament - E27 or E26

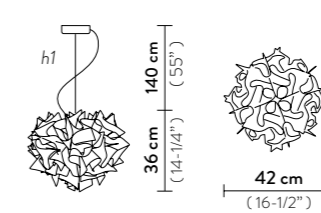

h1: maximum cable length

With: MagneticSystem®
Made of: Opalflex®

VELI TABLE Ø32

TABLE LAMP

Bulbs: 1 X 4W LED Filament - E14 or E12

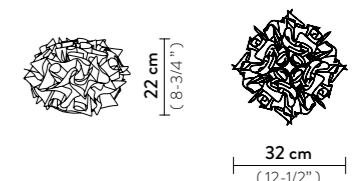

With: MagneticSystem®
Made of: Opalflex® / Metacrylate base

Price List: page 50

OPAL CHARCOAL PLUM

VELI 7

BY ADRIANO
RACHELE



VELI 7

SUSPENSION

Bulbs: 9X8W LED Filament - E27 or E26

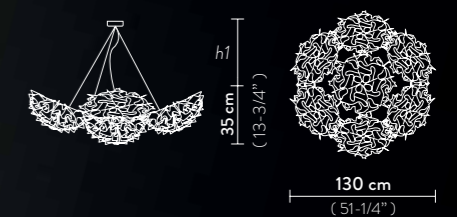

h1: maximum cable length: 400 cm / 156"
minimum cable length: 15 cm / 6"

With: 9 light sources

Made of: Opalflex® or Lentiflex® or
Goldflex® or Steelflex® or Copperflex®



Price List: page 54



DIMPLE BY PANTONE / PAVONCELLO

Originale e innovativa, Dimple coniuga minimalismo e rigore progettuale all'espressività multiforme della luce. L'esclusiva tecnica di modellazione a freddo del materiale conferisce alla superficie del prodotto una terza dimensione, in grado di spezzare la linearità della forma e renderla sinuosa e sensuale. Dimple è un caleidoscopio, la luce si riflette sui morbidi avvallamenti che corrono lungo tutta la superficie della lampada rivelando riflessi cromatici mutevoli.

Dimple is an original and innovative collection that joins minimalism and the rigour of design to the multifaceted expressions that light exudes. The exclusive cold-modelling technique transmits another dimension to the material's surface, breaking the linearity and making it sinuous and sensual. Dimple is a kaleidoscope where light is reflected in the linear hollows that cover the lamp's surface, revealing ever-changing coloured reflections.



DIMPLE SINGLE SILVER



DIMPLE SINGLE EMERALD



DIMPLE SINGLE BLUE



DIMPLE SINGLE ROSE



DIMPLE SINGLE ORANGE

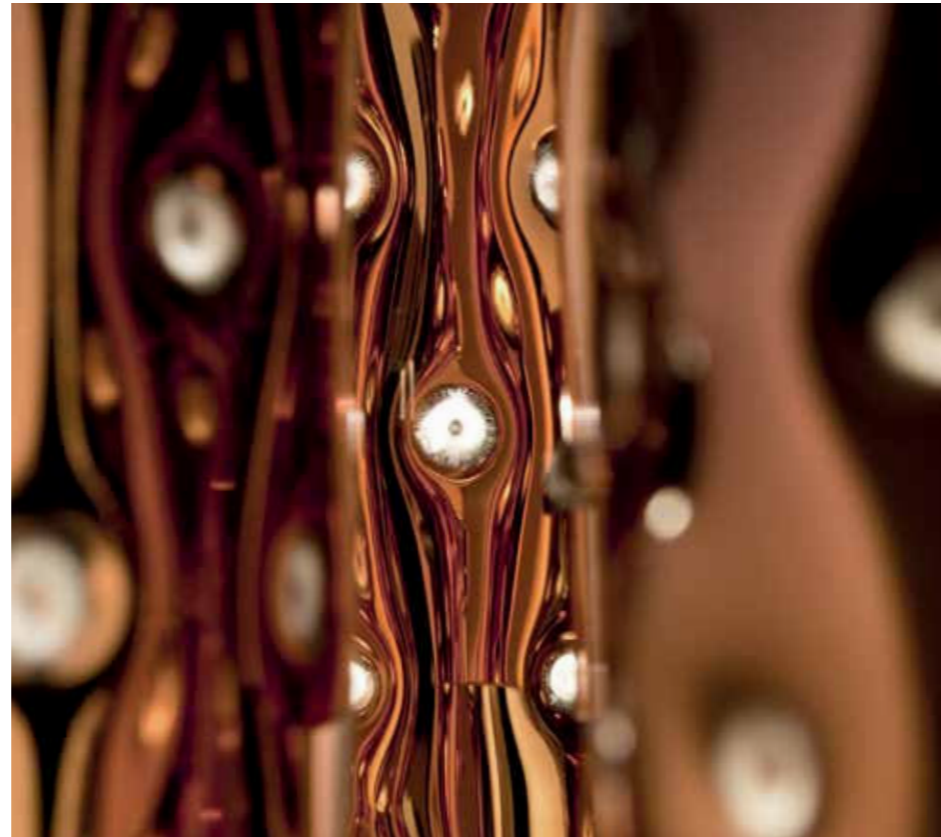

Da sinistra in senso orario: dettaglio interno del cilindro con effetti caleidoscopici; Dimple Orange con focus sulla modellazione a freddo del materiale; Dimple Floor Trio Emerald; dettaglio dell'effetto Crackle.

Clockwise from left: a close-up of the cylinder's kaleidoscope effects; Dimple Orange, a focus on the material's cold modulation; Dimple Floor Trio Emerald; Crackle effect detail.



DIMPLE PENTA

SUSPENSION

Bulbs: 5 X 8W LED Filament - E27 or E26
 Ø max 60 mm / 2,36"

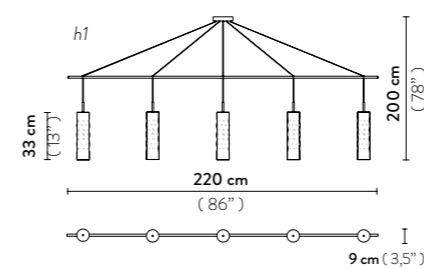

h1: maximum cable length

Made of: Cristalflex® / Stainless Steel

DIMPLE TRIO

SUSPENSION

Bulbs: 3 X 8W LED Filament - E27 or E26
 Ø max 60 mm / 2,36"

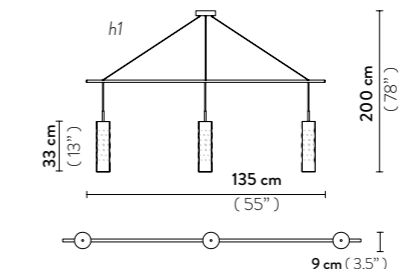

h1: maximum cable length

Made of: Cristalflex® / Stainless Steel

DIMPLE

SUSPENSION

Bulbs: 1 X 8W LED Filament - E27 or E26
 Ø max 60 mm / 2,36"

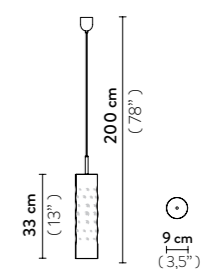

h1: maximum cable length

Made of: Cristalflex® / Stainless Steel

Price List: page 32

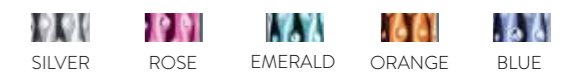

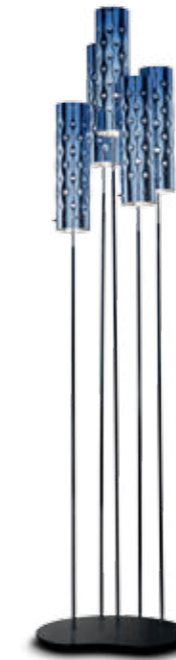

DIMPLE PENTA

FLOOR LAMP

Bulbs: 5 X 8W LED Filament - E27 or E26

Ø max 60 mm / 2,36"

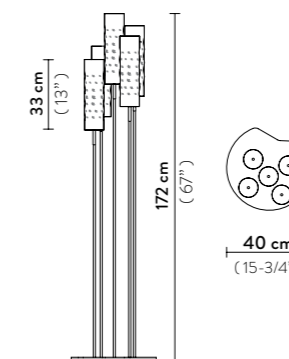

With: Dimmer Included

Made of: Cristalflex® / Stainless Steel

Price List: page 32



SILVER



ROSE



EMERALD



ORANGE



BLUE



DIMPLE TRIO

FLOOR LAMP

Bulbs: 3 X 8W LED Filament - E27 or E26

Ø max 60 mm / 2,36"

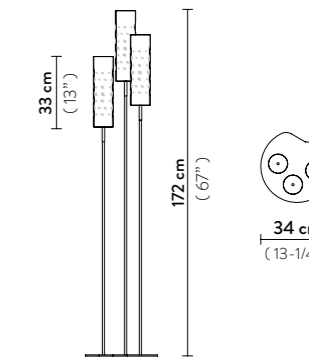

With: Dimmer Included

Made of: Cristalflex® / Stainless Steel



CLIZIA FUMÉ

BY ADRIANO RACHELE

Clizia Fumé Ceiling/Wall Large.

Forme regolari incastrate in un perfetto equilibrio di trasparenze e riflessi compongono il design di Clizia. La lampada riprende le forme della natura: è una nuvola che cattura la luce del sole delle prime ore del giorno e si carica di riflessi cangianti, è la chioma di un albero attraverso la quale la luce filtra e crea giochi con le ombre. Le versioni in cui è disponibile coniugano estetica e funzionalità: tutte sono dotate di un supporto magnetico che ancora la lampada alle superfici (ceiling e suspension) o alla base in metallo (table e floor). Clizia è un paesaggio che ravviva gli ambienti senza invaderli con la sua presenza.

Clizia is a series of shapes fit together to create a perfect balance of reflections and transparencies. The lamp has taken note of natural forms, resembling a cloud that captures the first changing rays of morning sun, or a treetop filtering a play of light and shadows. All of the available versions marry aesthetics with functionality, featuring a magnetic anchoring system, connecting them to the ceiling (for the suspensions and applique) or the metal base (for the table and floor lamps). Clizia transforms a space into a landscape without overwhelming it.



Clizia Fumè Suspension Large

CLIZIA L FUMÉ

SUSPENSION

Bulbs: 4 X 8W LED Filament - E27 or E26

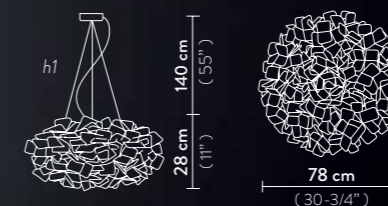

h1: maximum cable length

With: MagneticSystem®

Made of: Cristalflex® / Lentiflex®

Price List: page 36

CLIZIA M FUMÉ

SUSPENSION

Bulbs: 2 X 8W LED Filament - E27 or E26

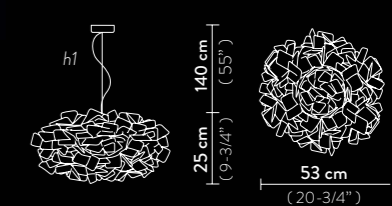

h1: maximum cable length

With: MagneticSystem®

Made of: Cristalflex® / Lentiflex®



FUMÉ



CLIZIA L FUMÉ

CEILING / WALL LAMP

Bulbs: 3 X 8W LED Filament - E27 or E26

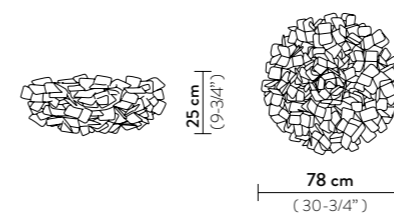

With: MagneticSystem®
Made of: Cristalflex® / Lentiflex®

CLIZIA M FUMÉ

CEILING / WALL LAMP

Bulbs: 2 X 8W LED Filament - E27 or E26

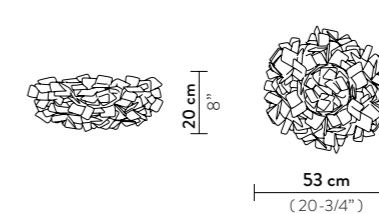

With: MagneticSystem®
Made of: Cristalflex® / Lentiflex®

CLIZIA MINI FUMÉ

CEILING / WALL LAMP

Bulbs: 1 X 4W LED Filament - E14 or E12

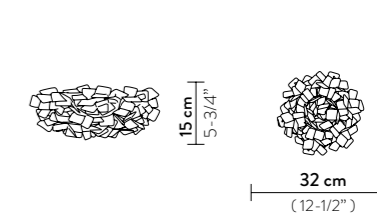

With: MagneticSystem®
Made of: Cristalflex® / Lentiflex®

Price List: page 36



FUMÉ



CLIZIA FUMÉ

FLOOR LAMP

Bulbs: 3 X 8W LED Filament - E27 or E26

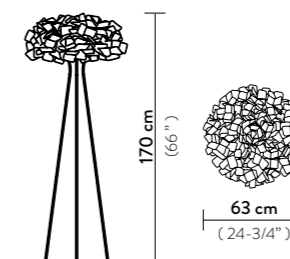

With: MagneticSystem®
Made of: Cristalflex® / Lentiflex®

Price List: page 36

TABLE LAMP

Bulbs: 1 X 4W LED Filament - E14 or E12

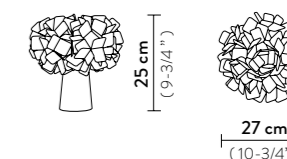

With: MagneticSystem®
Made of: Cristalflex® / Lentiflex®



FUMÉ



CLIZIA
BY **ADRIANO**
RACHELE



CLIZIA L

SUSPENSION

Bulbs: 4X8W LED Filament - E27 or E26

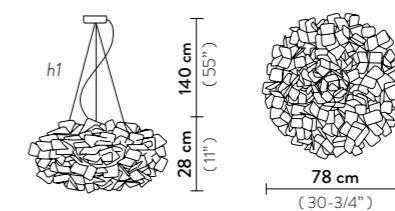

h1: maximum cable length

With: MagneticSystem®

Made of: Opalflex®

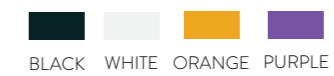

Price List: page 36

CLIZIA M

SUSPENSION

Bulbs: 2X8W LED Filament - E27 or E26

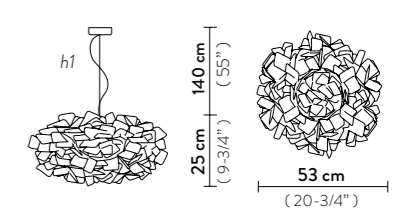

h1: maximum cable length

With: MagneticSystem®

Made of: Opalflex®



Price List: page 36



CLIZIA L

CEILING / WALL LAMP

Bulbs: 3X8W LED Filament - E27 or E26

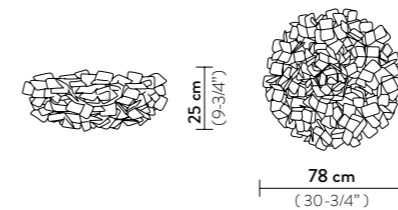

With: MagneticSystem®
Made of: Opalflex®

CLIZIA MINI

CEILING / WALL LAMP

Bulbs: 1X4W LED Filament - E14 or E12

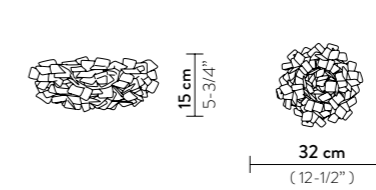

With: MagneticSystem®
Made of: Opalflex®

CLIZIA M

CEILING / WALL LAMP

Bulbs: 2X8W LED Filament - E27 or E26

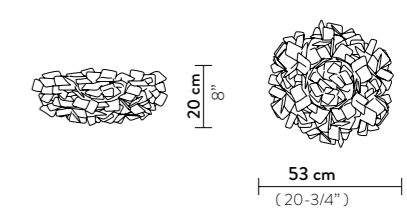

With: MagneticSystem®
Made of: Opalflex®

Price List: page 36





CLIZIA

FLOOR LAMP

Bulbs: 3 X 8W LED Filament - E27 or E26

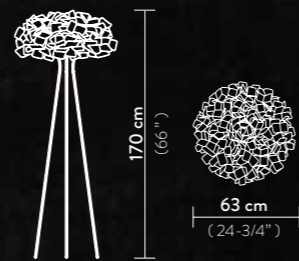

With: MagneticSystem®

Made of: Opalflex®

- BLACK
- WHITE
- PURPLE

Price List: page 36

CLIZIA

TABLE LAMP

Bulbs: 1 X 4W LED Filament - E14 or E12

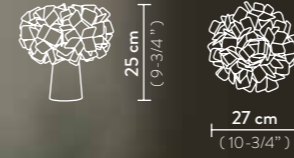

With: MagneticSystem®

Made of: Opalflex®

- BLACK
- WHITE
- ORANGE
- PURPLE

Price List: page 36

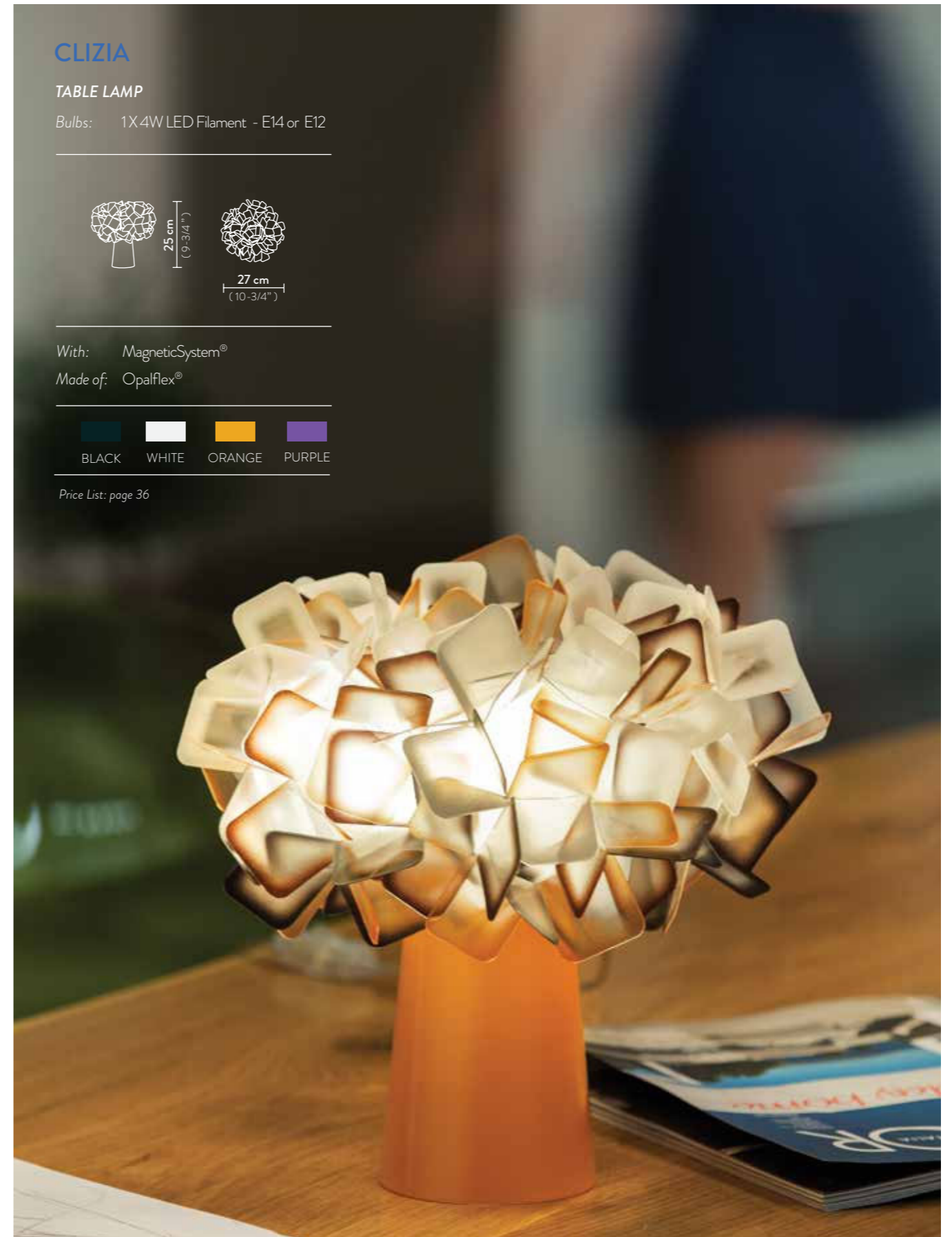



ÉTOILE

BY ADRIANO RACHELE

Étoile prende nome e ispirazione dal mondo della danza. Con leggerezza e sublime eleganza si libra nell'aria sprigionando tutta la sua luce che, complice della materia, parte dal cuore e raggiunge le superfici più esterne della lampada propagando nell'ambiente un'esplosione di energia e teatralità. In perfetto equilibrio su forme asimmetriche totalmente realizzate in Lentiflex®, Étoile è disponibile in due misure, per ambienti domestici o più scenografici.

Étoile's name was inspired by the world of classical dance. Its sublime weightlessness and elegance are due to the materials that spread the light throughout, from the heart to its edges. Étoile's theatrical, energetic explosion comes from the balance of Lentiflex® asymmetries, and is available in two sizes, both perfectly fit for any domestic or public environment.







ÉTOILE L

SUSPENSION

LED: 35W - 220V or 30W - 120V
3.500 Lumen - 2700 Kelvin
(warm white) CRI90

Triac Dimmable (Trailing Edge min. 20W)

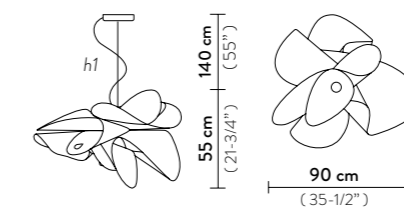

h1: maximum cable length

With: 3 LED Sources

Made of: Lentiflex®

Price List: page 44

ÉTOILE S

SUSPENSION

LED: 35W - 220V or 30W - 120V
3.500 Lumen - 2700 Kelvin
(warm white) CRI90

Triac Dimmable (Trailing Edge min. 20W)

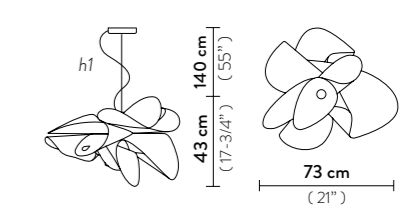

h1: maximum cable length

With: 3 LED Sources

Made of: Lentiflex®



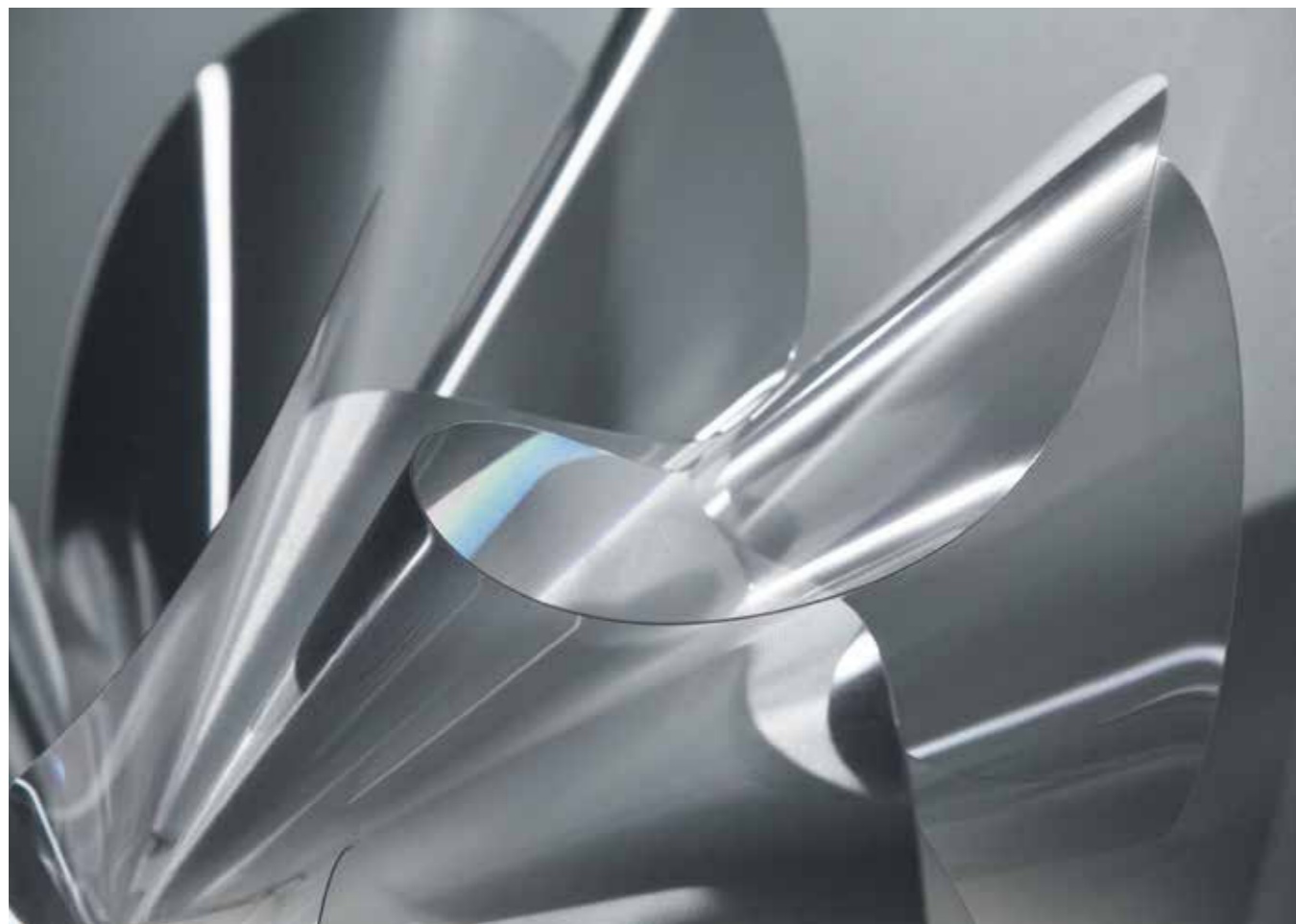

ÉTOILE

CEILING / WALL LAMP

LED: 30W - 220V or 120V
3,500 Lumen - 2700 Kelvin
(warm white) CRI90

Triac Dimmable (Trailing Edge min. 20W)



With: MagneticSystem®
Made of: Lentiflex®

Price List: page 44





HUGO BY SLAMP CREATIVE TEAM

Corre da un capo all'altro dello spazio, parallela al pavimento, obliqua, perpendicolare. Hugo, nella versatile finitura setosa di colore bianco, personalizza l'ambiente con un disegno sinuoso e con la morbidezza della luce dei LED diffusa in maniera uniforme dal tecnopolimero stampato. Disporre Hugo in serie in modo longitudinale o in sequenza libera è una scelta individuale, adatta tanto a un progetto decorativo quanto illuminotecnico. Disponibile anche nella versione Prisma Lentiflex®, premiata con il Wallpaper Design Award, per un effetto di luce cangiante.

A suspension lamp that flows from one end of a space to another, hung and arranged parallel, slanted, or perpendicular to the ground. Hugo's new, silky white finish is both elegant and versatile, customizing any space with its sinuous design and evenly diffused, soft light, shining through its printed techno-polymer structure. One is free to hang Hugo parallel to the ceiling, or create a series of the lamps to fit their desired decorative lighting design. The lamp is also available in a tenacious version made of Prisma Lentiflex® (winner of the Wallpaper Design Award), that has a flowing, liquid effect.





Dall'alto in senso orario: dettaglio della finitura fluida di Hugo Prisma; installazione in forma lineare di Hugo Prisma; dettaglio della copertura in acciaio con incisione a laser del brand Slamp.

Clockwise from the top: close-up of Hugo Prisma's liquid effect; linear installation of Hugo Prisma; close-up of Hugo's cap with Slamp's laser-engraved brand logo.



HUGO

SUSPENSION

LED: 30W - 220V or 120V
3.000 Lumen - 2700 Kelvin
CRI > 90

Triac Dimmable (Trailing Edge min. 20W)

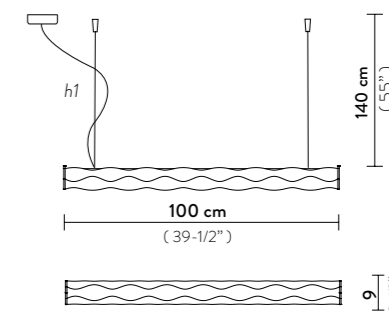

h1: maximum cable length

Made of: Lentiflex®

Price List: page 42

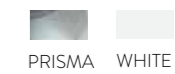



SLAMP



HUGO ARCHITECTURAL SYSTEM BY SLAMP CREATIVE TEAM

Per rispondere alle necessità illuminotecniche degli architetti nei progetti di grandi spazi, senza rinunciare all'anima decorativa, è stato sviluppato un sistema che consente di allestire insieme molteplici sospensioni Hugo attraverso un unico cavo elettrico. Con Hugo Architectural System si può dar vita a un'infinità di combinazioni: dalla più regolare sul perimetro di una stanza senza la necessità di operare scassi a soffitto, alla più scenografica che prevede le lampade in uno shanghai multiforme a diverse altezze. L'Architectural Team di Slamp è a disposizione dei progettisti nello sviluppo di una composizione tailor made.

The Hugo Architectural System is a functional yet highly decorative response to architects' need for lighting options in large spaces. The system allows for the use of multiple Hugo lamps with only one electric cable. The Hugo Architectural System can be used to create infinite combinations, from perimeter lighting without invasive wires, to a dramatic, multilevel, illuminative sculpture. Slamp's Team of Architects is available to tailor the system into a composition fit for any design project.



HUGO "ARCHITECTURAL SYSTEM"

Nell'immagine, un esempio di installazione lineare di Hugo. Il cavo elettrico è connesso al soffitto in un unico punto e alimenta tutti gli altri corpi luminosi tramite un cavo di lunghezza variabile. L'ancoraggio degli elementi al soffitto avviene con cavi d'acciaio regolabili.

Hugo can be installed linearly, as seen in the photo. The electric wire, connected to the ceiling at a single point, provides power to all of the other lamps through a wire that can be adjusted to the desired length.



HUGO "ARCHITECTURAL SYSTEM"

design by Slamp Creative Department

• COMPONENTS:

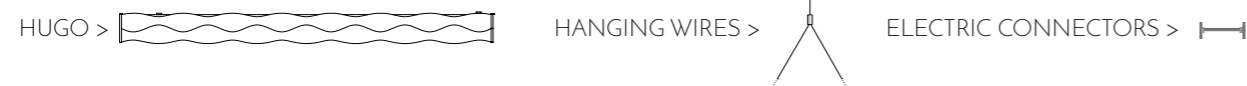

• DETAILS:

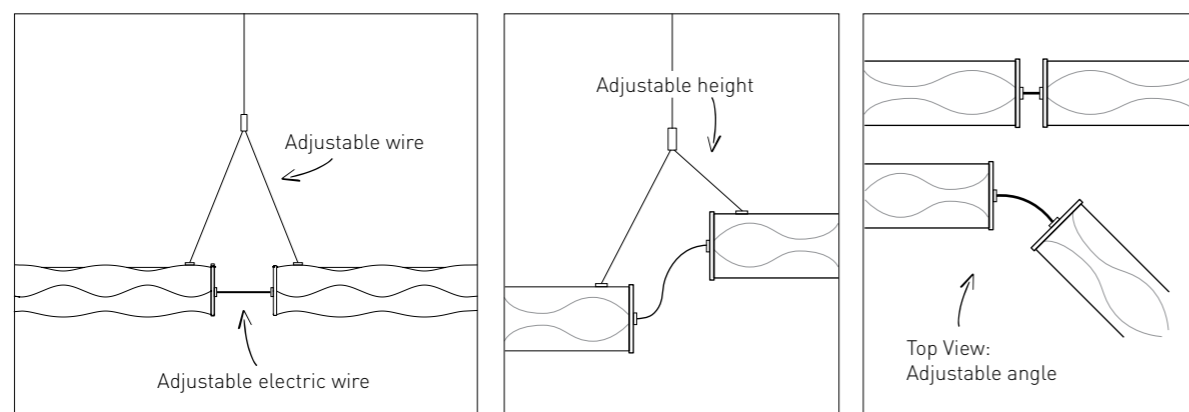

• LINEAR OPTION:

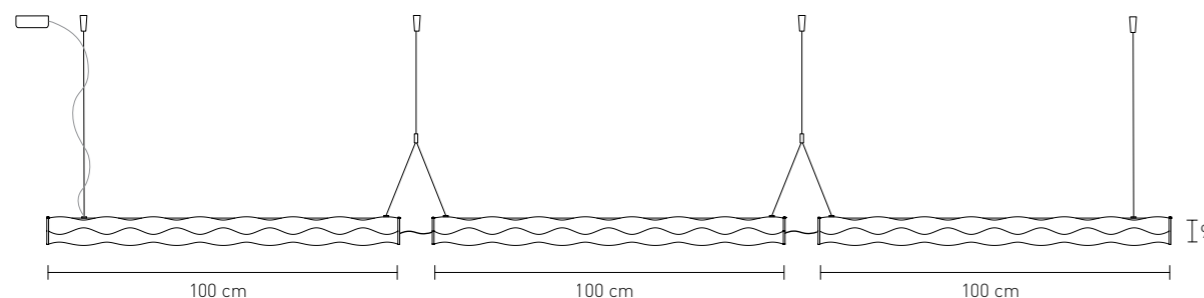

Comporre il proprio sistema illuminotecnico con HUGO è facilissimo e consente di ottenere un risultato elegante e di estremo rigore progettuale. A differenza del modulo singolo, ARCHITECTURAL SYSTEM permette di avere una sola coppetta da cui discende il cavo di alimentazione e i moduli possono essere connessi tra loro in multipli avvalendosi dei cavi regolabili dati in dotazione. Nella pagina accanto, alcuni suggerimenti di installazione mostrano la flessibilità del sistema di montaggio.

Arranging an elegant and highly personalized lighting system with HUGO is simple. The ARCHITECTURAL SYSTEM uses only one ceiling rose and one principle wire, allowing multiple units to be arranged using the supplied connecting wires in variable, personalized lengths. On the next page: Installation options show the flexibility of the hanging system.

-  **SINGLE HUGO LED POWER:** 30W - 220V or 120 V - 3000 Lumen - 2700 Kelvin - CRI > 90

• LINEAR, WITH ANGLE >

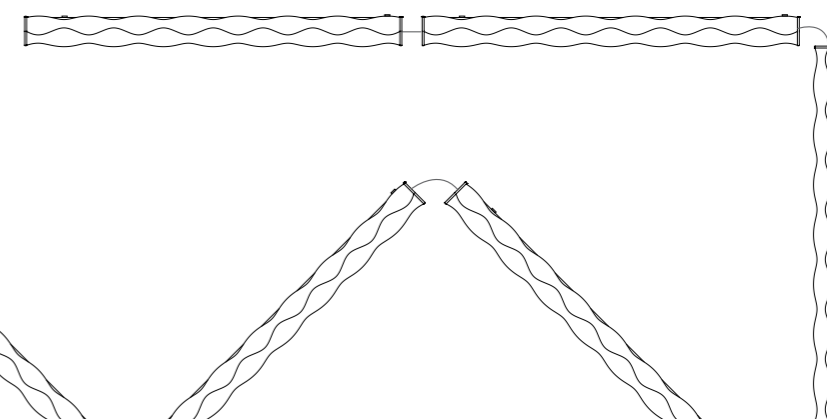

• ZIG ZAG >

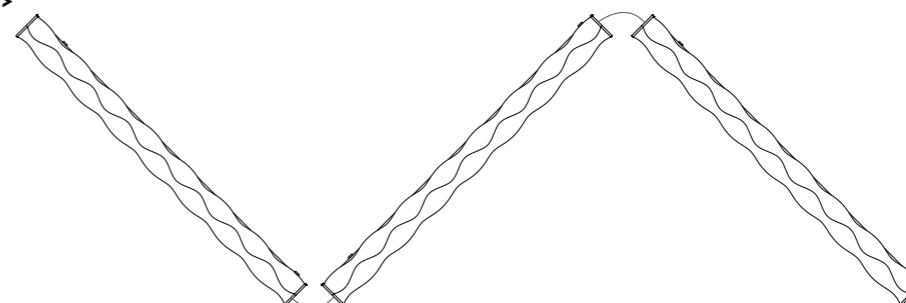

• CIRCULAR >

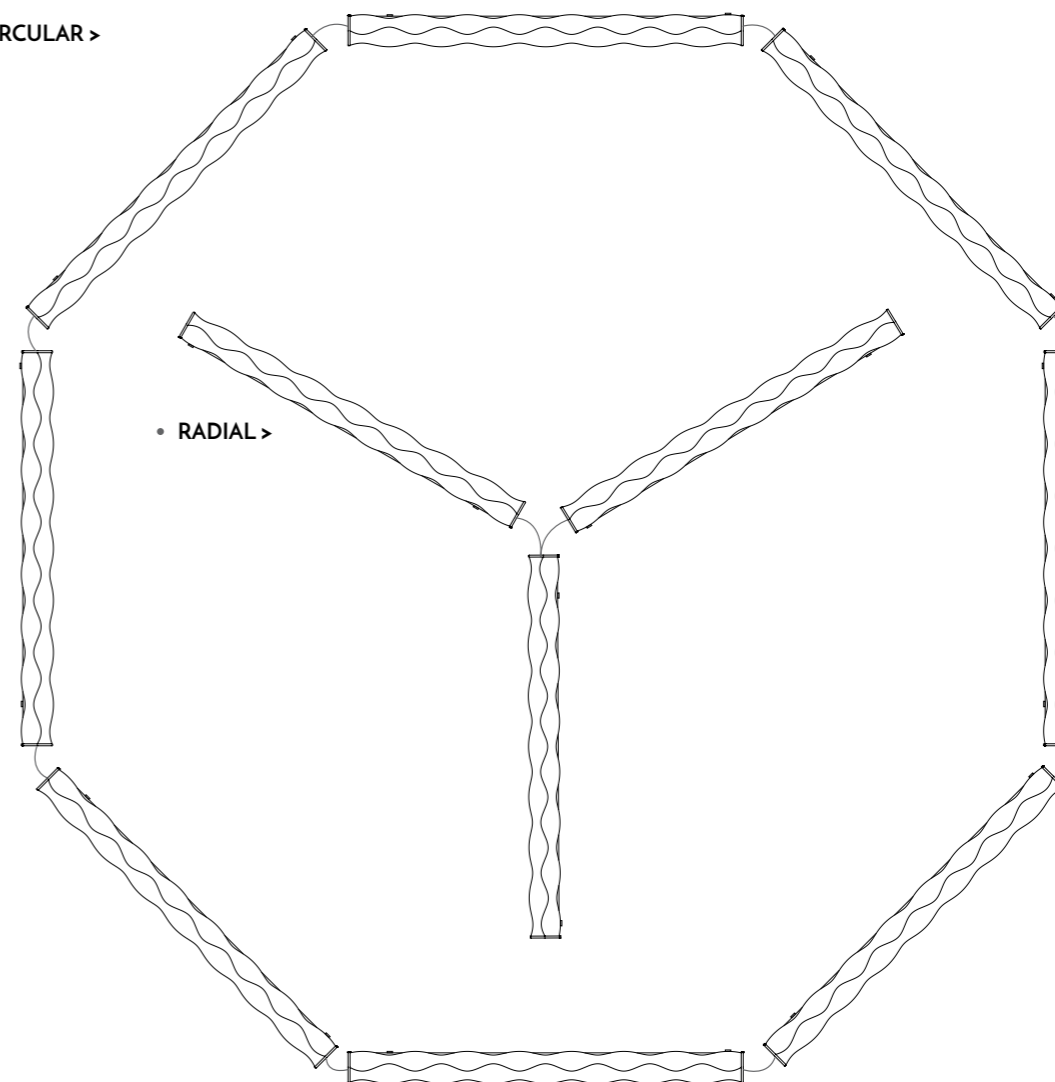

• RADIAL >

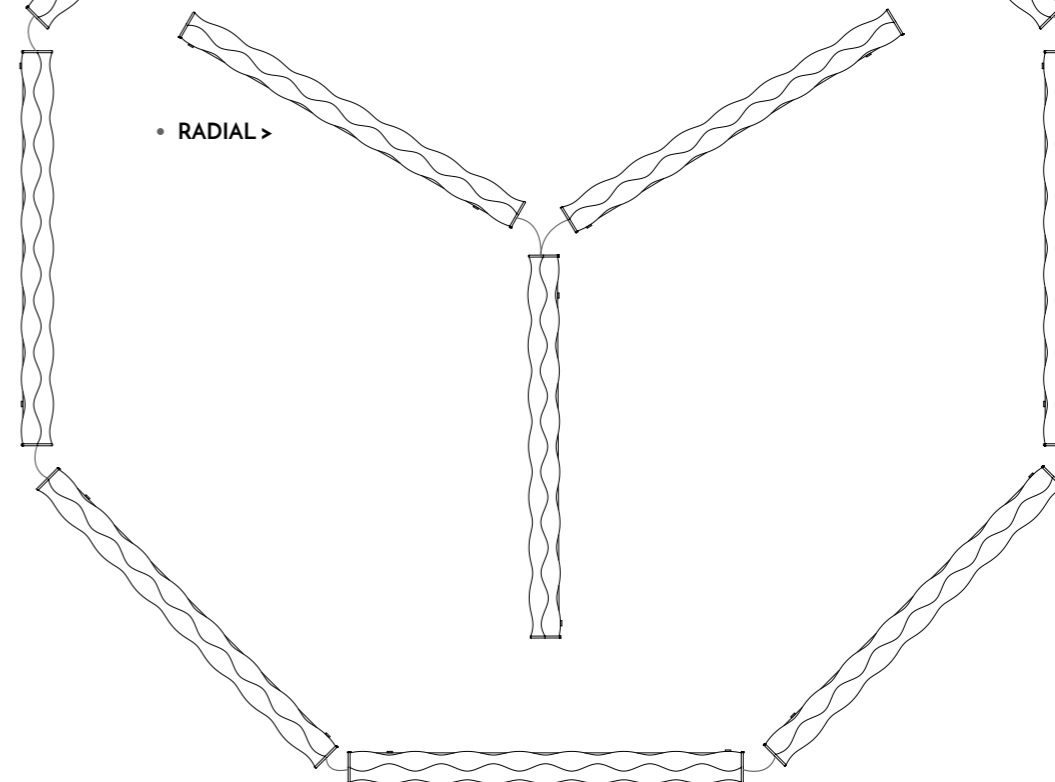



MIRAGE BY MANUEL WIJFFELS

Un'illusione ottica ricreata in un'appliche dalla forma longilinea che si presta ad allestimenti multipli in geometrie lineari o in disposizioni libere. La luce diventa decoro tramite la corolla di LED che brilla come un fuoco d'artificio al centro della struttura rivelandosi solo all'accensione. La superficie prismatica del diffusore richiama, per etimologia ed estetica, l'affinità con il vetro e le trasparenze del cristallo.

An optical illusion, enclosed in an applique fit to be used in linear, geometric, or random groupings. Light turns into pure adornment; the central LED source explodes from inside the structure, creating fireworks only when the lamp is turned on. The prismatic surface bridges aesthetics and etymology, resembling the transparencies of glass and crystal.

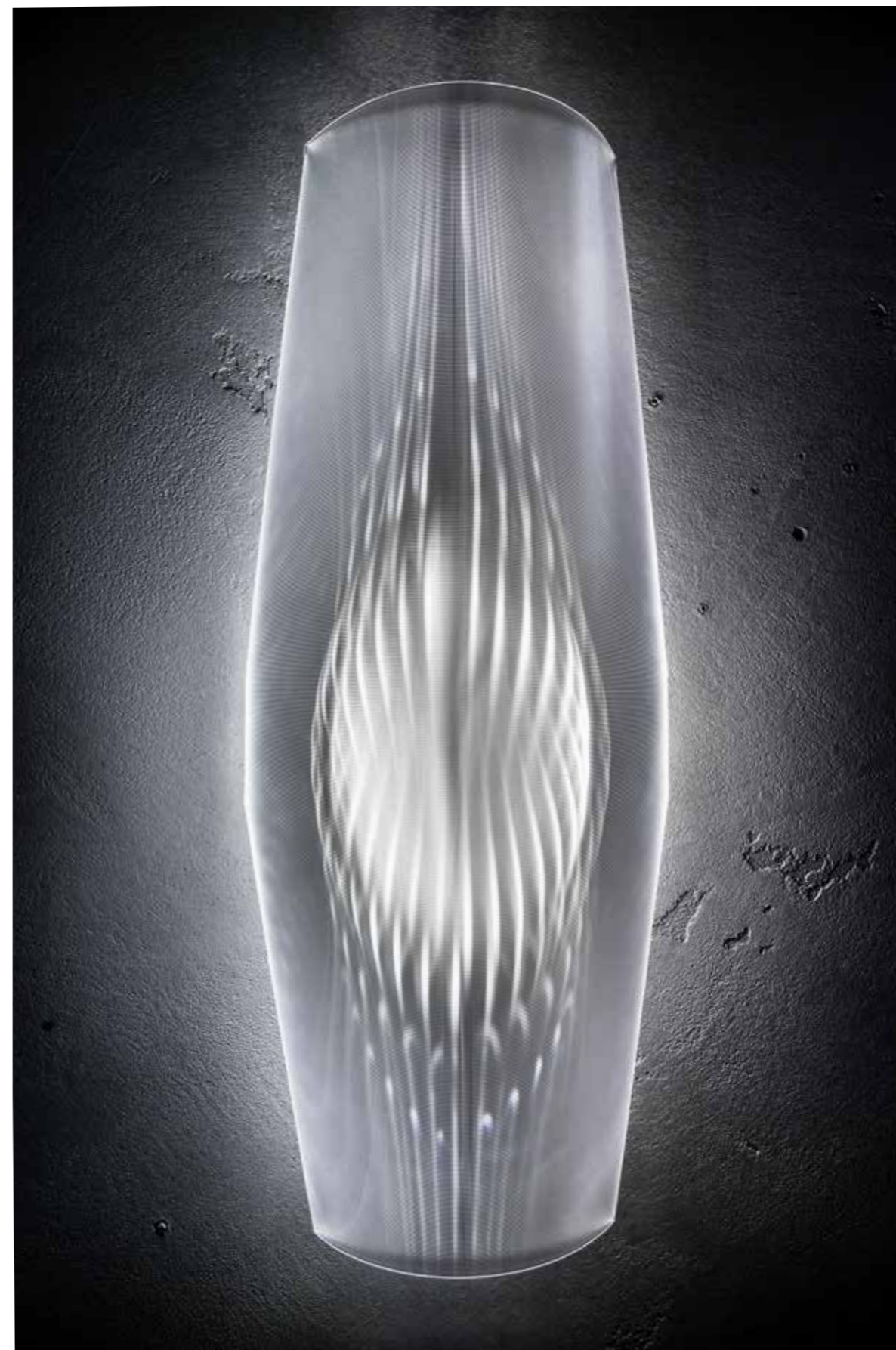



Side View



Front View

MIRAGE

WALL LAMP

LED: 14W - 220Vac or 120Vac / 12Vdc
1100 Lumen - 2700 Kelvin

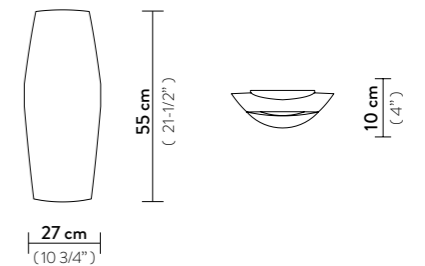

With: Stainless Steel Support

Made of: Lentiflex®

Price List: page 56





FABULA BY COSTANTINO MOROSIN

Realizzata a mano concatenando elementi di Lentiflex®, Fabula ricorda una lunga e soffice fascia di seta avvolta su se stessa. Nelle inedite versioni a sospensione e plafoniera da 60 cm di diametro, l'effetto cangiante del materiale è reso più scintillante dalle 5 fonti luminose che garantiscono l'illuminazione di ambienti di grandi dimensioni. Un design suggestivo e sofisticato, disponibile anche nelle funzioni d'uso plafoniera e sospensione da 48 cm di diametro, che arricchiscono lo spazio con eleganza.

Fabula appears to be a long, silky piece of fabric wound around itself. The new Prisma versions for ceiling and wall are 60 cm in diameter, handmade with Lentiflex®, and feature 5 light sources that make it perfect for illuminating large spaces. The ceiling, floor, and 48 cm suspension bring a touch of elegance to any space.

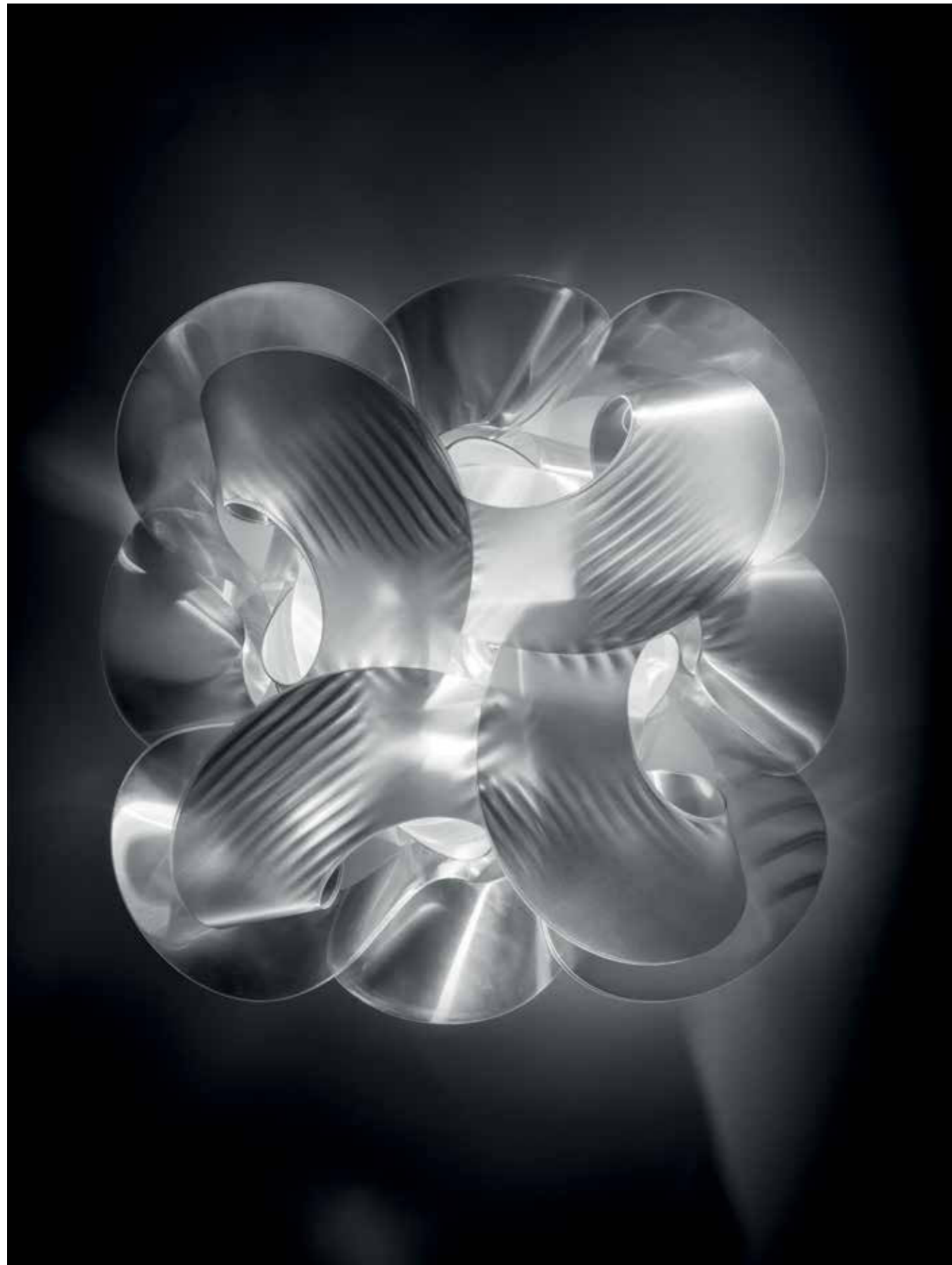



Fabula ceiling Large, Ø 60



Fabula ceiling Ø 48,5

FABULA L

CEILING / WALL LAMP

Bulbs: 5X8W LED Filament - E27 or E26

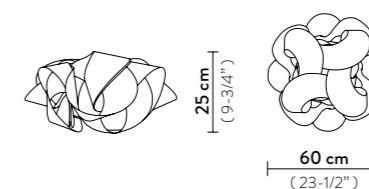

With: MagneticSystem®

Made of: Lentiflex®

Price Lis: page 30

FABULA

CEILING / WALL LAMP

Bulbs: 3X8W LED Filament - E27 or E26

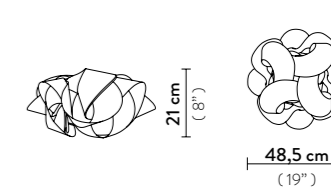

With: MagneticSystem®

Made of: Lentiflex®



FABULA L

SUSPENSION

Bulbs: 5X8W LED Filament - E27 or E26

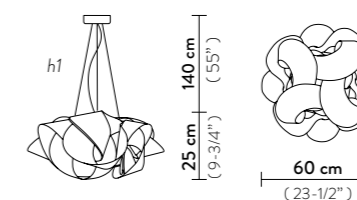

h1: maximum cable length

With: MagneticSystem®

Push-Pull System®

Made of: Lentiflex®

Price List: page 30

FABULA

SUSPENSION

Bulbs: 3X8W LED Filament - E27 or E26

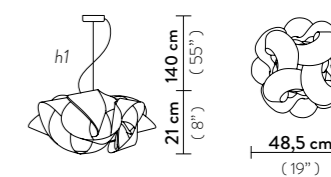

h1: maximum cable length

With: MagneticSystem®

Push-Pull System®

Made of: Lentiflex®





BACH

BY FRANCESCO
PARETTI

Snella e raffinata, Bach è un corpo statuario e dalle tinte chiare. Le sue eleganti ma rigorose forme si legano alle moderne curvature capaci di seguire perfettamente le linee di ogni ambiente architettonico. Bach è la lampada adatta a regalare movimento e luminosità agli interior, permettendo di comporre degli angoli che rendono l'ambiente più accogliente, grazie ai suoi colori versatili e alle diverse altezze in cui è disponibile.

Slim and refined, Bach is stately, with elegant yet rigorous curves perfectly adept to any modern environment. The light tones of the Couture version were inspired by fabrics, bringing movement and illumination to any interior. Bach is available in various heights and sizes, that when grouped together, create welcoming nooks filled with warm chromatics.





BACH XXL

FLOOR LAMP

Bulbs: 3 X 8W LED Filament - E27 or E26

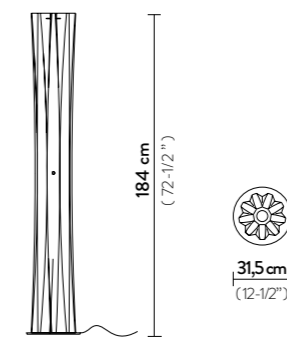

With: Stainless Steel Base - Dimmer included

Made of: Opalflex®

Price List: page 60

BACH XL

FLOOR LAMP

Bulbs: 3 X 8W LED Filament - E27 or E26

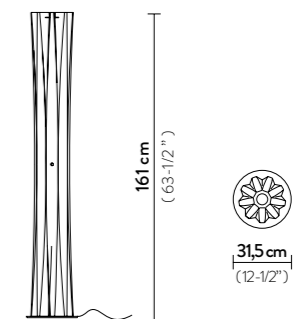

With: Stainless Steel Base - Dimmer included

Made of: Opalflex®

WHITE GOLD



BACH L

FLOOR LAMP

Bulbs: 2X 8W LED Filament - E27 or E26

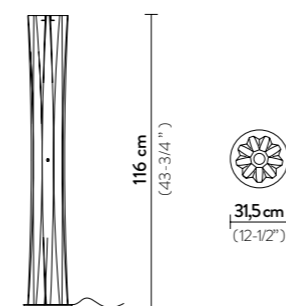

With: Stainless Steel Base - Dimmer included

Made of: Opalflex®

BACH M

TABLE LAMP

Bulbs: 1X 8W LED Filament - E27 or E26

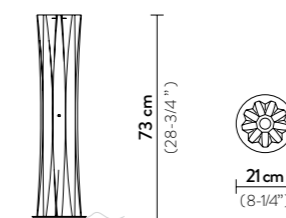

With: Stainless Steel Base - Dimmer included

Made of: Opalflex®

BACH S

TABLE LAMP

Bulbs: 1X 8W LED Filament - E27 or E26

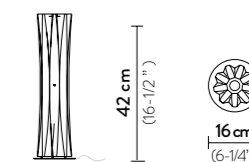

With: Stainless Steel Base - Dimmer included

Made of: Opalflex®

Price List: page 60

WHITE GOLD

CEREMONY

BY BRUNO RAINALDI

Suntuoso inno alla femminilità: Ceremony è una lampada opulenta che evoca una gonna e un ballo, una collana di perle, il drappeggio di una scollatura. La luce delle 5 fonti luminose si diffonde tra le "collane" di tecnopolimeri donandole un forte impatto scenografico. E' una presenza la cui imponenza si contrappone, esaltandola, alla sua intrinseca leggerezza.

Ceremony is an opulent lamp, an ode to femininity that conjures up the image of the brush of a skirt, a pearl choker, drapery on décolleté. The five light sources are spread over technopolymer "necklaces" that bring an air of drama and intrinsic weightlessness to its powerful presence.





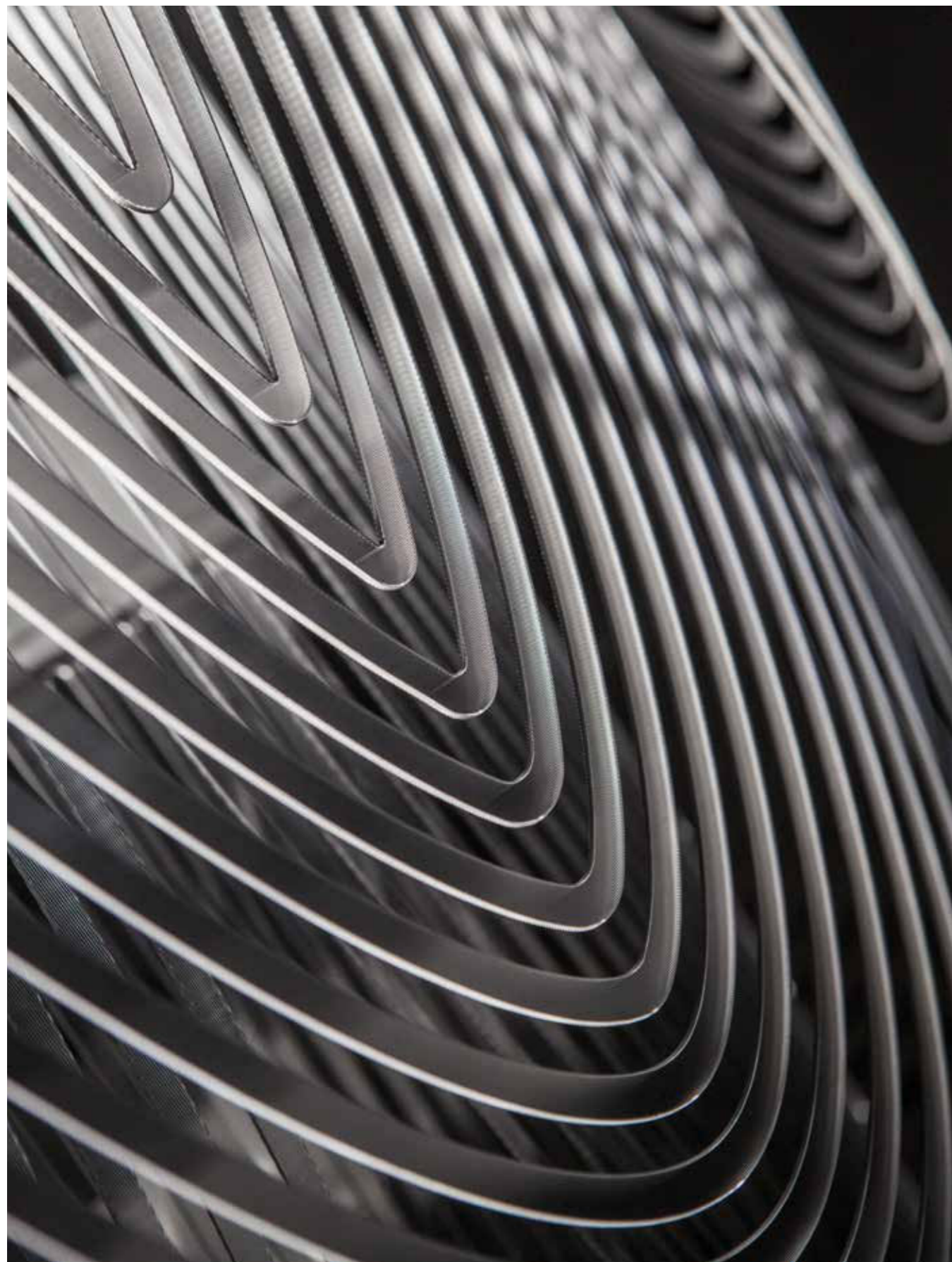

Ceremony Ø 90

CEREMONY L

SUSPENSION

Bulbs: 4 X 8W LED Filament - E27 or E26
+ 1 X 4W GU10 Spot LED - E27 or E26

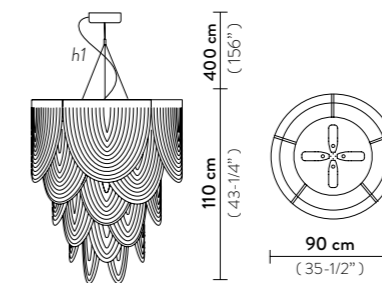

h1: maximum cable length

Made of: Opalflex® / Cristalflex®

Price List: page 62

CEREMONY S

SUSPENSION

Bulbs: 3 X 8W LED Filament - E27 or E26
+ 1 X 4W GU10 Spot LED - E27 or E26

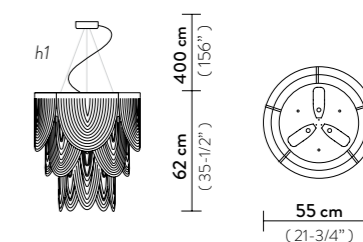

h1: maximum cable length

Made of: Opalflex® / Cristalflex®

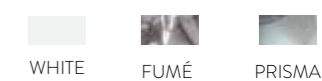

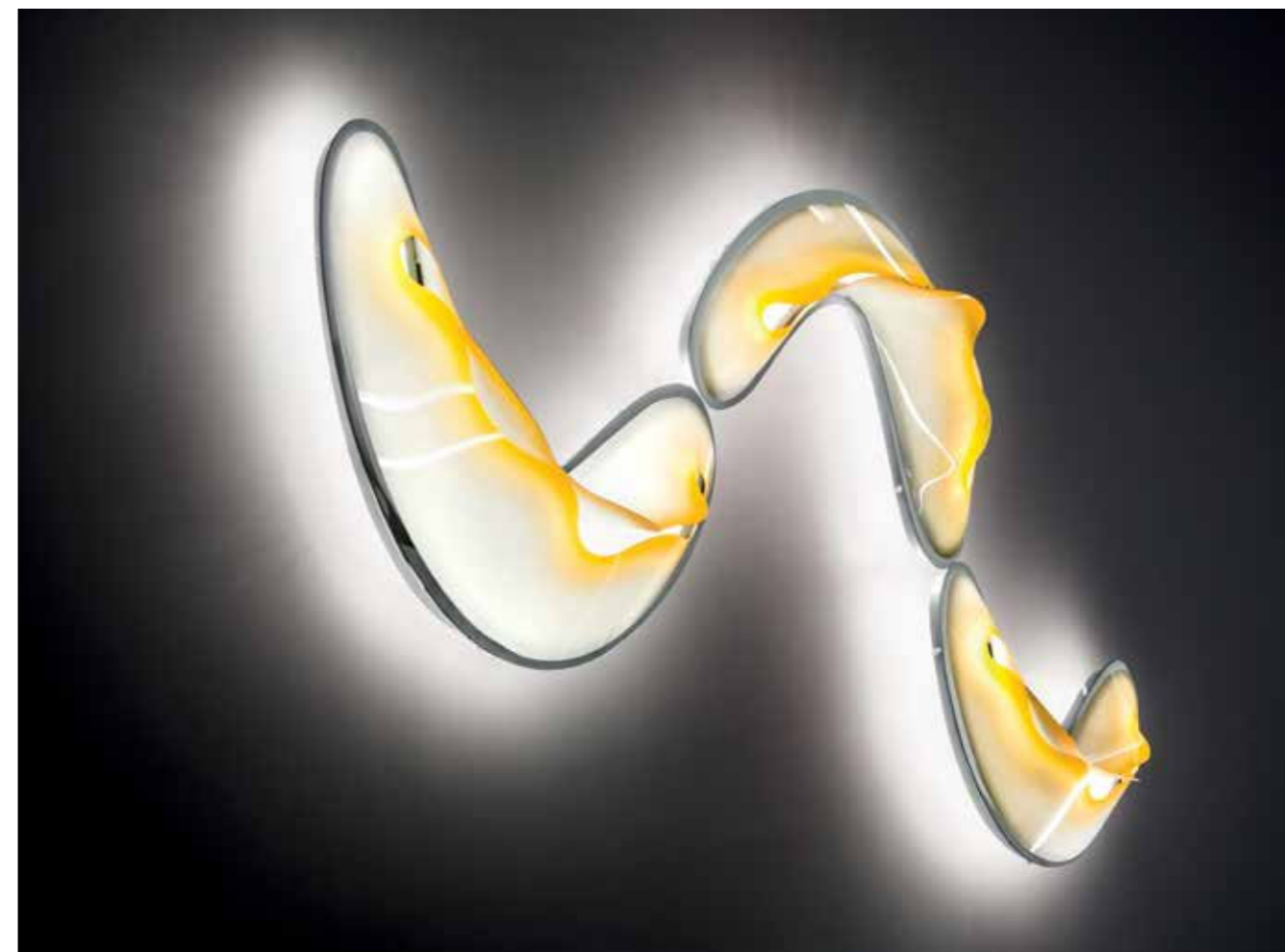

CROCCO BY NIGEL COATES

Una lampada che gioca con la luce in maniera innovativa ridisegnando lo spazio, in composizioni multiple su parete, nelle versioni applique, o nella versione sospesa a tre moduli che sembra quasi galleggiare nell'aria. La luminosità del Lentiflex® dona al diffusore, sostenuto da un supporto in metallo una forma zoomorfa, aumentata dalla sfumatura colorata dell'effetto morphing che, incontrando la luce dei LED, rende la superficie setosa e scalda l'ambiente.

Crocco creates innovative plays of light that literally redesign the concept of space, whether it be a composition of multiple applique elements, or the three-module suspension that seems to float through the air. The fauna-inspired metal frame supports LED technology diffused by Lentiflex® in various colour shading, achieved through a morphing effect. The silky surface warms any space.

CROCCO L

CEILING / WALL LAMP

LED: 20W - 220Vac or 120Vac / 12Vdc
1600 Lumen - 2700 Kelvin

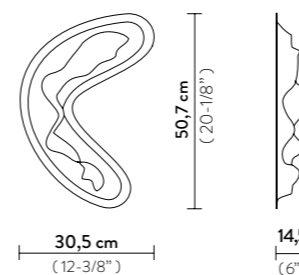

CROCCO M

CEILING / WALL LAMP

LED: 18W - 220Vac or 120Vac / 12Vdc
1400 Lumen - 2700 Kelvin

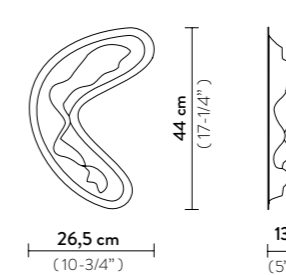

inches: Ø 55" - h 51 1/4" - max height 55"

CROCCO S

CEILING / WALL LAMP

LED: 15W - 220Vac or 120Vac / 12Vdc
1200 Lumen - 2700 Kelvin

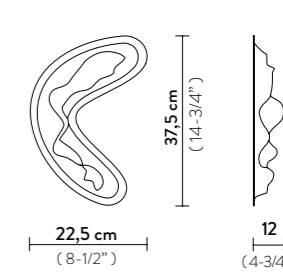

With: Stainless Steel support
Made of: Lentiflex®

With: Stainless Steel support
Made of: Lentiflex®

With: Stainless Steel support
Made of: Lentiflex®

Price List: page 48



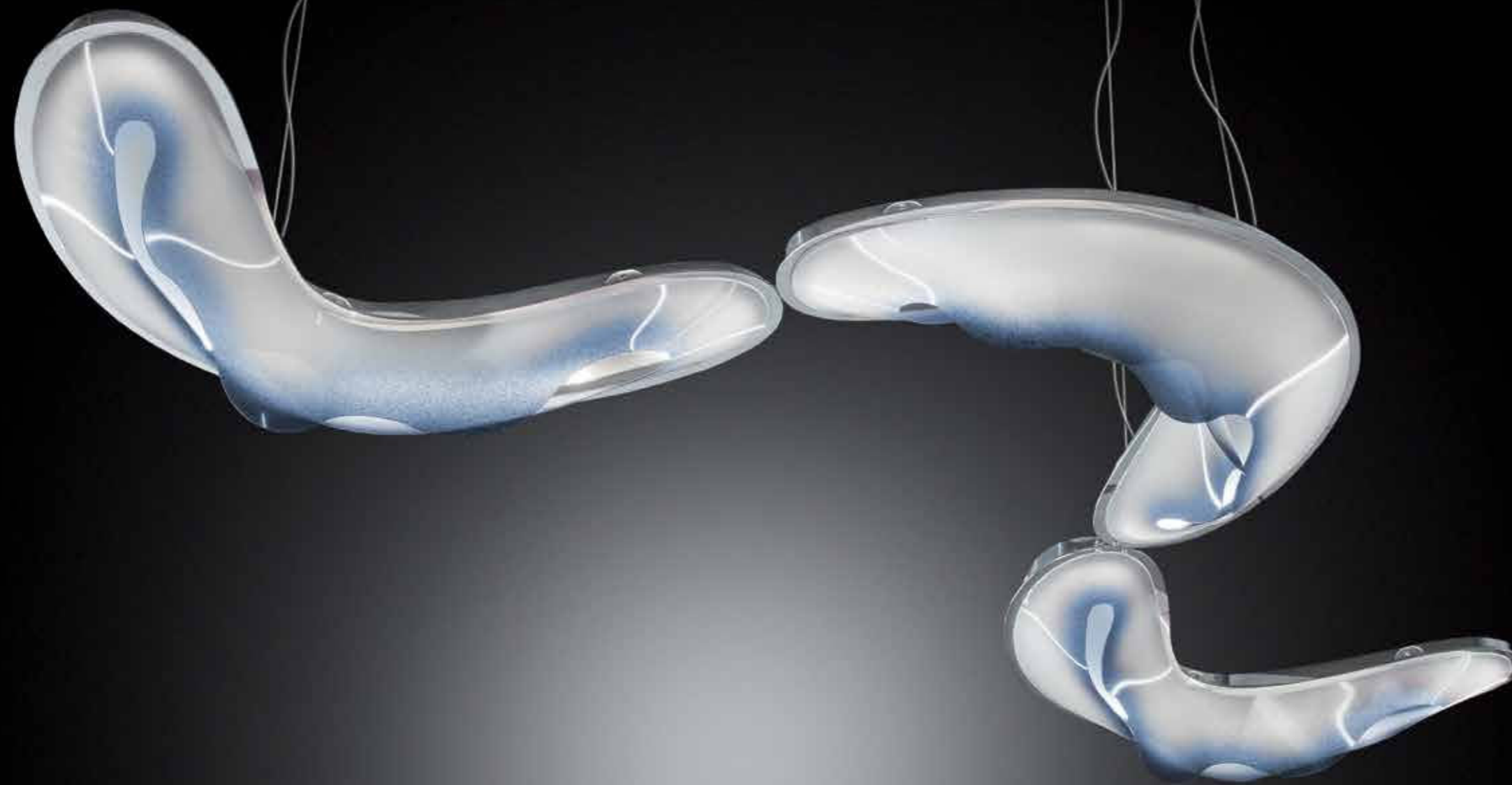

CROCCO

SUSPENSION

LED: 54W - 220Vac or 120Vac/ 12Vdc
4200 Lumen - 2700 Kelvin

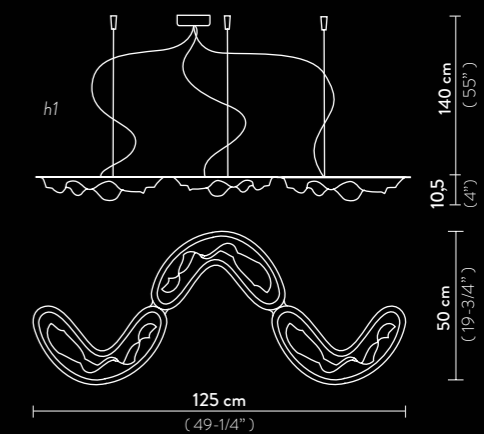

h1: maximum cable length

With: Stainless Steel support

Made of: Lentiflex®



Price List: page 48



FIGRELLA BY NIGEL COATES

Realistica, avvolgente e suggestiva con i suoi naturalistici dettagli conduce l'immaginazione verso un mondo floreale dove la realtà dei piccoli cespugli arruffati di bosso incontra la magia del fresco figurativismo e delle seducenti potenzialità espressive di Slamp. Riflessioni di petali giocano con la luce e si disperdono sulle pareti di ogni interior, trasformando in un incantesimo le sequenze di ombre e rifrazioni proiettate nello spazio.

Suggestive, realistic and welcoming; Fiorella's natural details conjure up a world covered in flora. Slamp's expressive powers and fresh figurativism meet in a flurry of reflective, luminous petals that transform and enchant any interior with their sequence of lighting fragments and shadows cast across the walls.



FIGURELLA MINI

SUSPENSION

Bulbs: 1X 8W LED Filament - E27 or E26

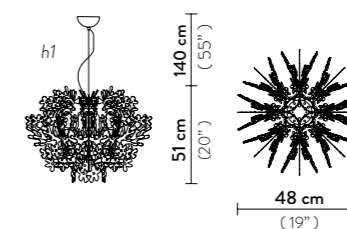

h1: maximum cable length

Made of: Opalflex® / Cristalflex®

Price List: page 58

WHITE GOLD SILVER COPPER

WALL LAMP

Bulbs: 1X 4W LED Filament - E14 or E12

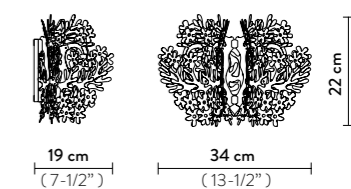

h1: maximum cable length

Made of: Opalflex® / Cristalflex®

Price List: page 58

WHITE FUMÉ



Fiorella Suspension
White.

FIORELLA

SUSPENSION

Bulbs: 1X8W LED Filament - E27 or E26

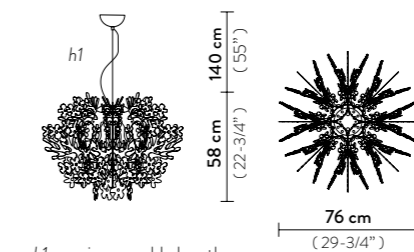

h1: maximum cable length

Made of: Opalflex® / Cristalflex®

Price List: page 58

WALL LAMP

Bulbs: 1X8W LED Filament - E27 or E26

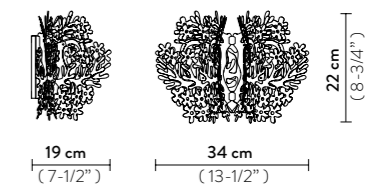

h1: maximum cable length

Made of: Opalflex® / Cristalflex®

WHITE FUMÉ

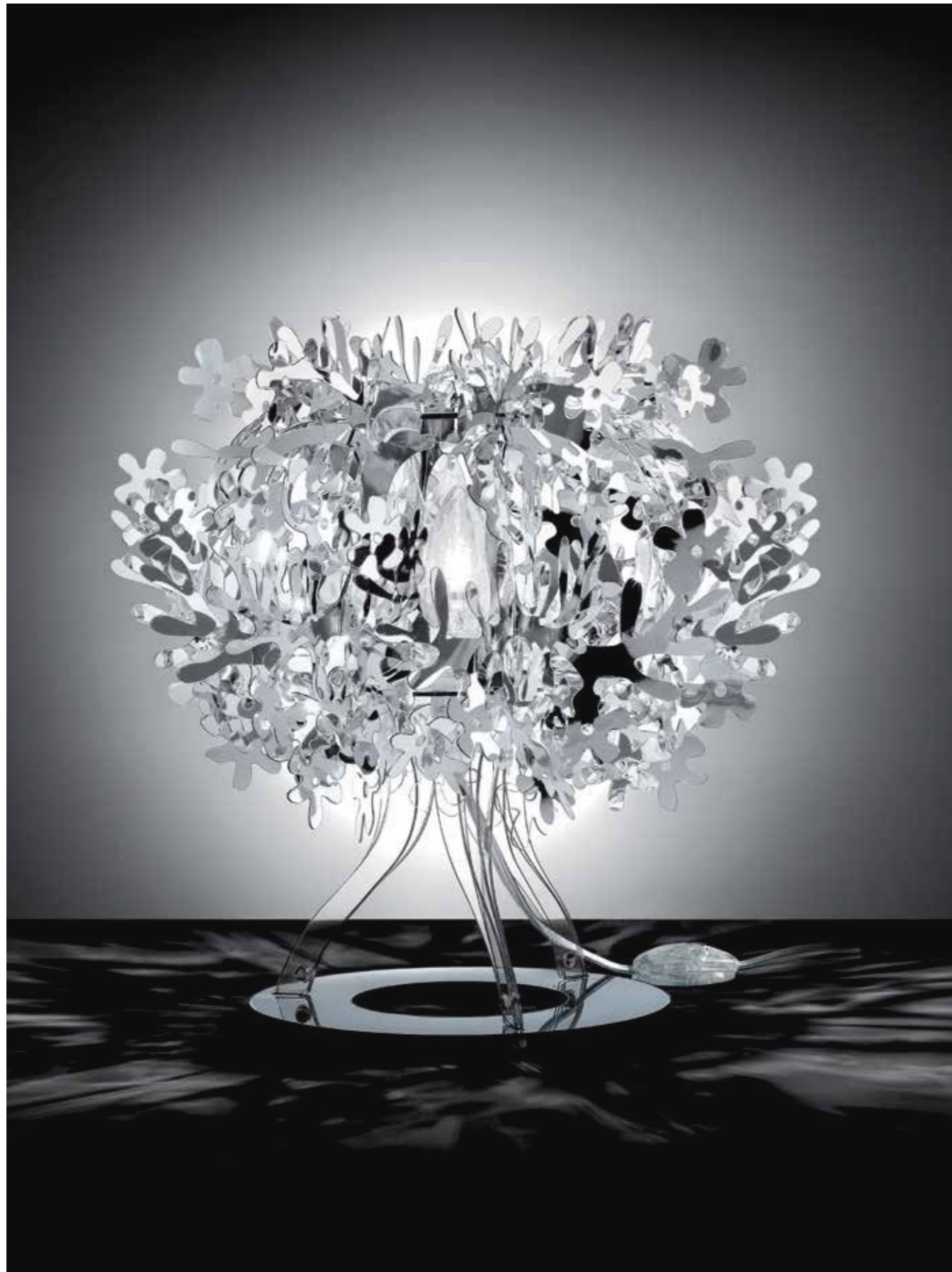

FIORELLINA

TABLE LAMP

Bulbs: 1X 4W LED Filament - E14 or E12

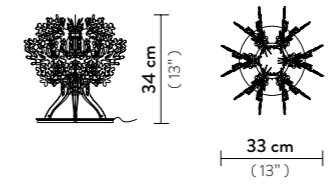

Made of: Opalflex® / Cristalflex®



FIORELLA

FLOOR LAMP

Bulbs: 1X 8W LED Filament - E27 or E26

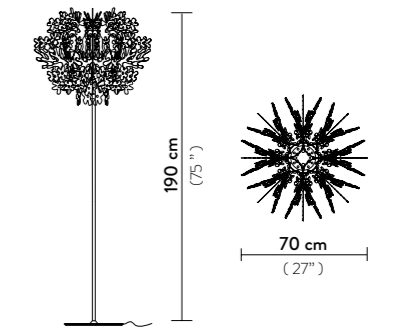

Made of: Opalflex® / Cristalflex®



Price List: page 58

DIAMOND BY PAOLUCCI, STADERA

Scultorea, dinamica e contemporanea, ispirata alle più iconiche sculture del Brancusi, Diamond ha un design geometrico che, incontrando la luce, si delinea fino ad accentuarne le forme sfaccettate. Una scultura luminosa che, nelle tre diverse dimensioni, rimane perfettamente adeguata ad ogni arredo: da una stanza da letto per illuminare i comodini a un soggiorno moderno, specie se in multipli.

Sculptural, dynamic, and modern, inspired by the iconic works of Brancusi. Diamond's geometric design allows the light to accentuate its various facets and angles. The luminous sculpture is available in three dimensions, each fit for different areas, from bedside tables to sitting rooms, and when grouped together, they create domestic installations.



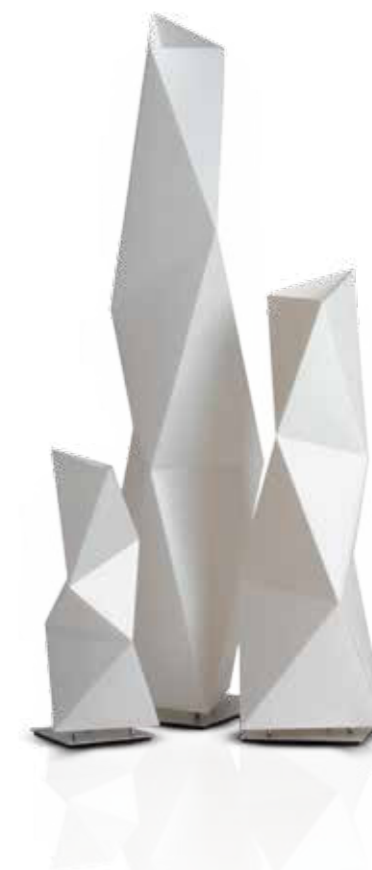
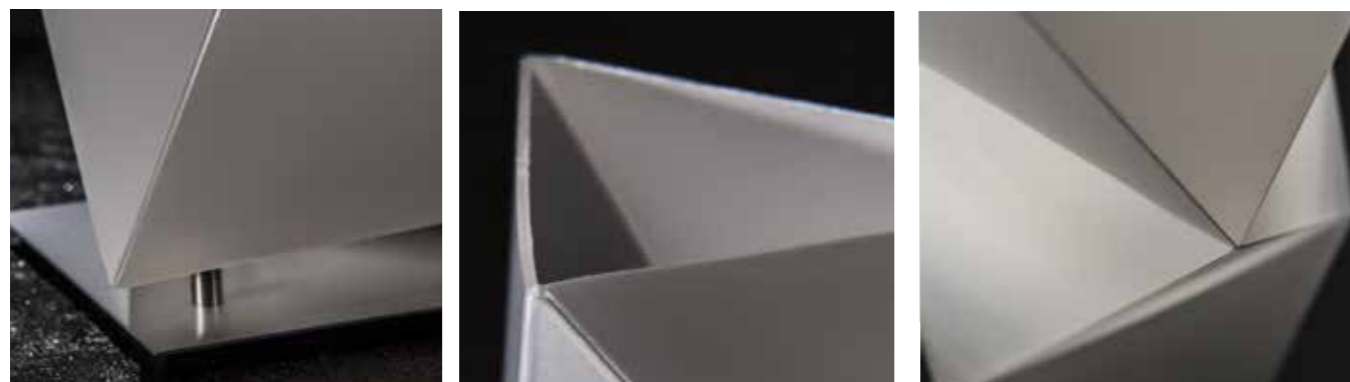

DIAMOND L

FLOOR LAMP

Bulbs: 1X 8W LED Filament - E27 or E26

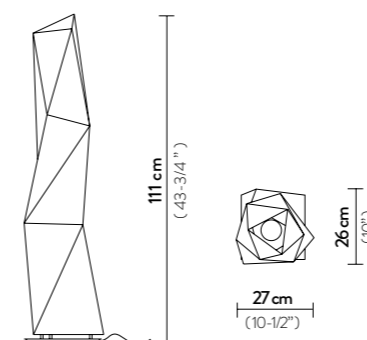

With: Aluminium Base
Made of: Opalflex®

DIAMOND M

TABLE LAMP

Bulbs: 1X 8W LED Filament - E27 or E26

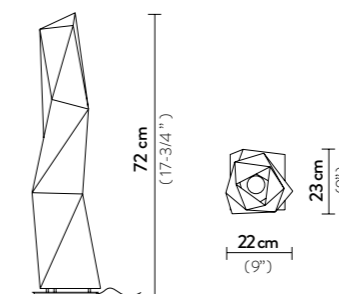

With: Aluminium Base
Made of: Opalflex®

DIAMOND S

TABLE LAMP

Bulbs: 1X 4W LED Filament - E14 or E12

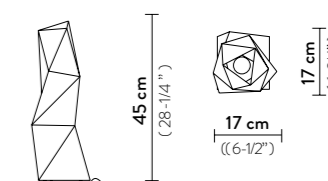

With: Aluminium Base
Made of: Opalflex®

Price List: page 78

WHITE



WOODY BY LUCA MAZZA

Design minimalista, tratto grafico deciso e dinamico dove luce, forma e decoro incorniciano lo spazio in un quadro suggestivo e contemporaneo. Woody è una collezione di lampade ispirata alla naturalezza e al mondo animale. Nella versione da terra con arco regolabile, la base in legno di rovere chiaro richiama la texture di nodi e venature della sospensione, entrambe disponibili in 4 colori.

Minimalist design meets strong, dynamic graphic printing to create light, shape and decor that frame any space, making it suggestive yet modern. Woody is a collection inspired by flora and fauna, and the floor version features an adjustable body connected to a light oak base that reflects the knots and veining of the shade. Both the floor and suspension lamps are available in four colours.



Da sinistra in senso orario: Woody Suspension Orange; Woody suspension nella varie colorazioni; dettaglio della texture con nodi e venature; dettaglio del portalampada; dettaglio della base in legno di rovere.

Clockwise from the left: Woody Suspension Orange; some of the Woody suspension lamp's colours; close-up of the wood-printed texture; close-up of the bulb-base; close-up of the oak base.



WOODY

SUSPENSION

Bulbs: 1 X 8W LED Filament, E27 or E26

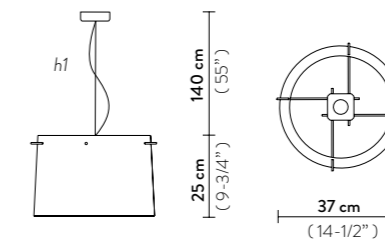

h1: maximum cable length

Made of: Polycarbonate / Wood

Price List: page 74

FLOOR LAMP

Bulbs: 1 X 8W LED Filament, E27 or E26

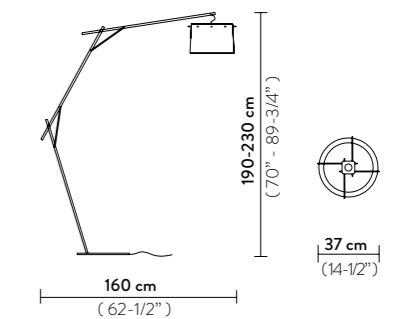

With: Wood Base / Dimmer Included

Made of: Polycarbonate / Wood

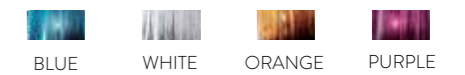



AURORA

BY NIGEL COATES

L'aurora è l'apparizione della luce, dorata e rosea, che appare nel cielo poco prima del sorgere del sole. Il cuore della lampada, composto di cristalli, amplifica la luce di questa raffinata plafoniera che sembra quasi volteggiare al ritmo dei suoi riflessi, mentre diffonde grazia ed eleganza in tutta la stanza. Disponibile sia in bianco che in nero, è una scelta anche funzionale grazie al supporto magnetico che permette una facile installazione e manutenzione.

The aurora is a rose gold apparition of light taking over the sky just before sunrise. The heart of this refined ceiling lamp is made of crystals that almost pulse a rhythm of reflections, casting an aura of grace and elegance throughout any space. The lamp is available in black and white versions with our functional magnetic system for easy installation and care

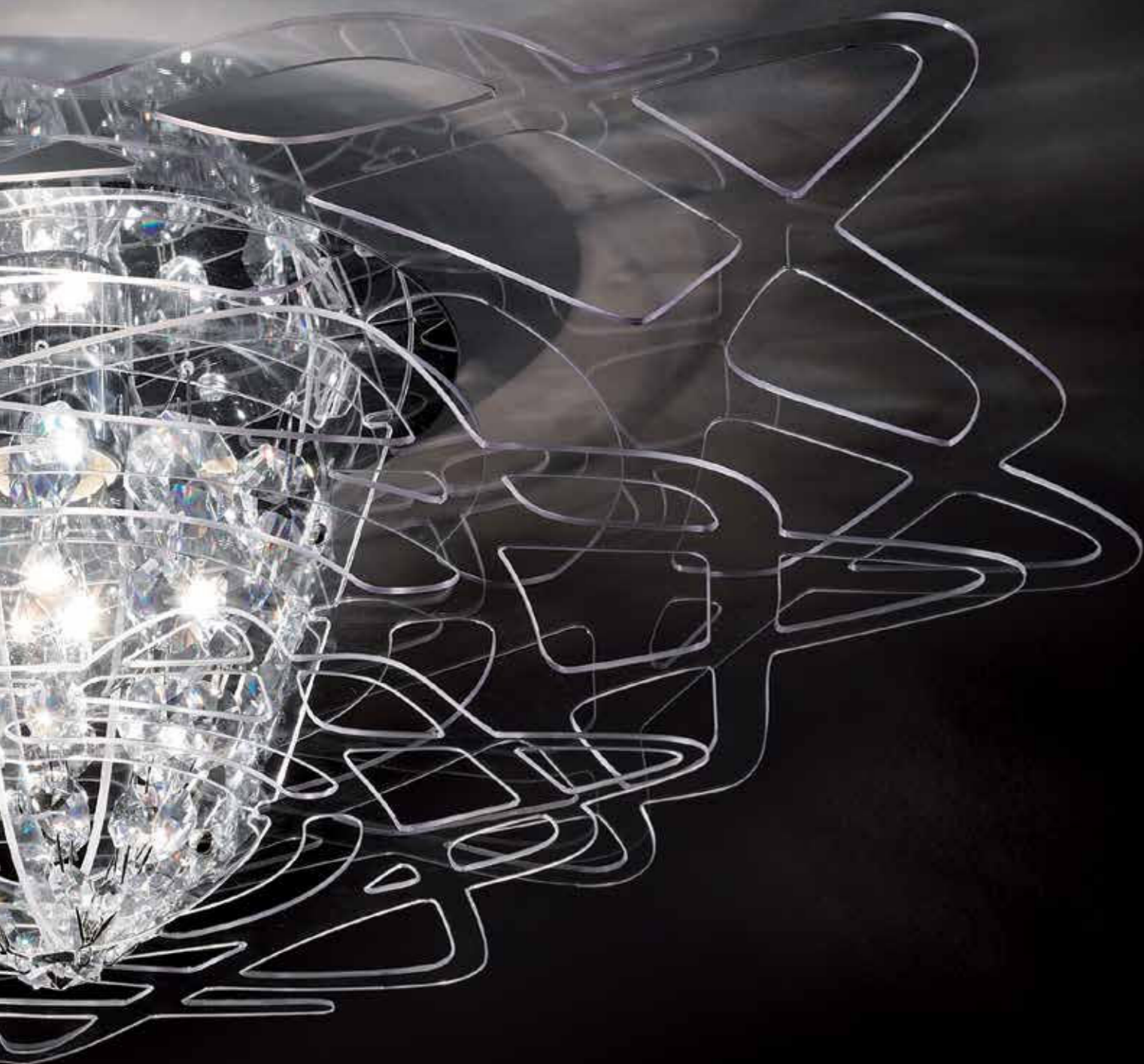

AURORA L

CEILING LAMP

Bulbs: 1X 8W LED Filament - E27 or E26

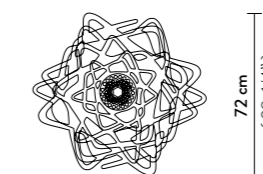
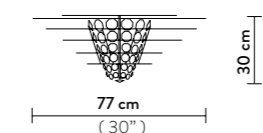

With: MagneticSystem®
Made of: Plainflex® and 97 Crystals

Price List: page 73



BLACK WHITE

AURORA MINI

CEILING LAMP

Bulbs: 1X 8W LED Filament - E27 or E26

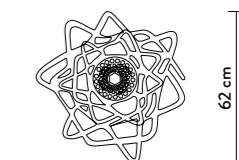
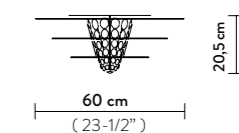

With: MagneticSystem®
Made of: Plainflex® or Cristalflex®
and 51 Crystals



TRANSPARENT FUMÉ WHITE BLACK



CACTUS BY ADRIANO RACHELE

La capacità di adattamento agli ambienti di questa lampada richiama esattamente ciò a cui si ispira. La sua iconicità combina la geometria alla tecnologia d'avanguardia dei materiali utilizzati per le due varianti: il Lentiflex® e l'Opalflex®. Entrambi donano un fulgore irresistibile e riflessi prismatici suggestivi. Disponibile sia in bianco, in 4 misure, che nella versione prisma trasparente, in tre diverse misure, Cactus si presta ad essere un dono perfetto e permette di immaginare e ricreare degli angoli spiritosi e ricercati.

This lamp has the extraordinary ability to adapt to any space while remaining quite true to its inspiration. It owes its iconicity to the combination of geometry and the innovation of the materials used for both versions: Lentiflex® e l'Opalflex®. Both emanate an irresistible brilliance and suggestive prismatic reflections. Cactus is available in 4 white versions, and 3 transparent prisma versions, all bringing imaginative possibilities to any area, introducing a dose of desired quirkiness.

CACTUS M

TABLE LAMP

Bulbs: 1X4W LED Filament - E14 or E12

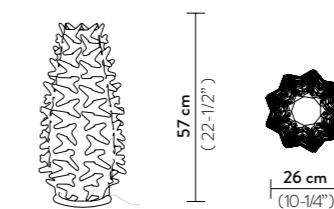

With: Stainless Steel Base

Made of: Opalflex®

Price List: page 68

GOLD

CACTUS S

TABLE LAMP

Bulbs: 1X4W LED Filament - E14 or E12



With: Stainless Steel Base

Made of: Opalflex®

CACTUS XXL

FLOOR LAMP

Bulbs: 2X8W LED Filament - E27 or E26

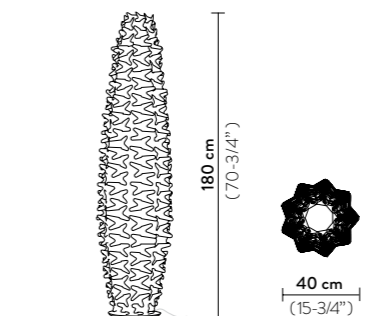

With: Stainless Steel Base

Made of: Opalflex®

Price List: page 68

GOLD

CACTUS XL

FLOOR LAMP

Bulbs: 2X8W LED Filament - E27 or E26

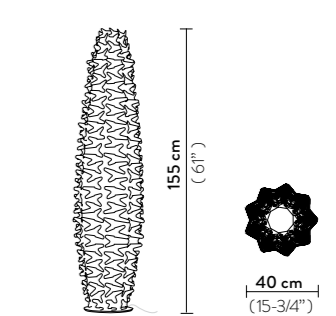

With: Stainless Steel Base

Made of: Opalflex®

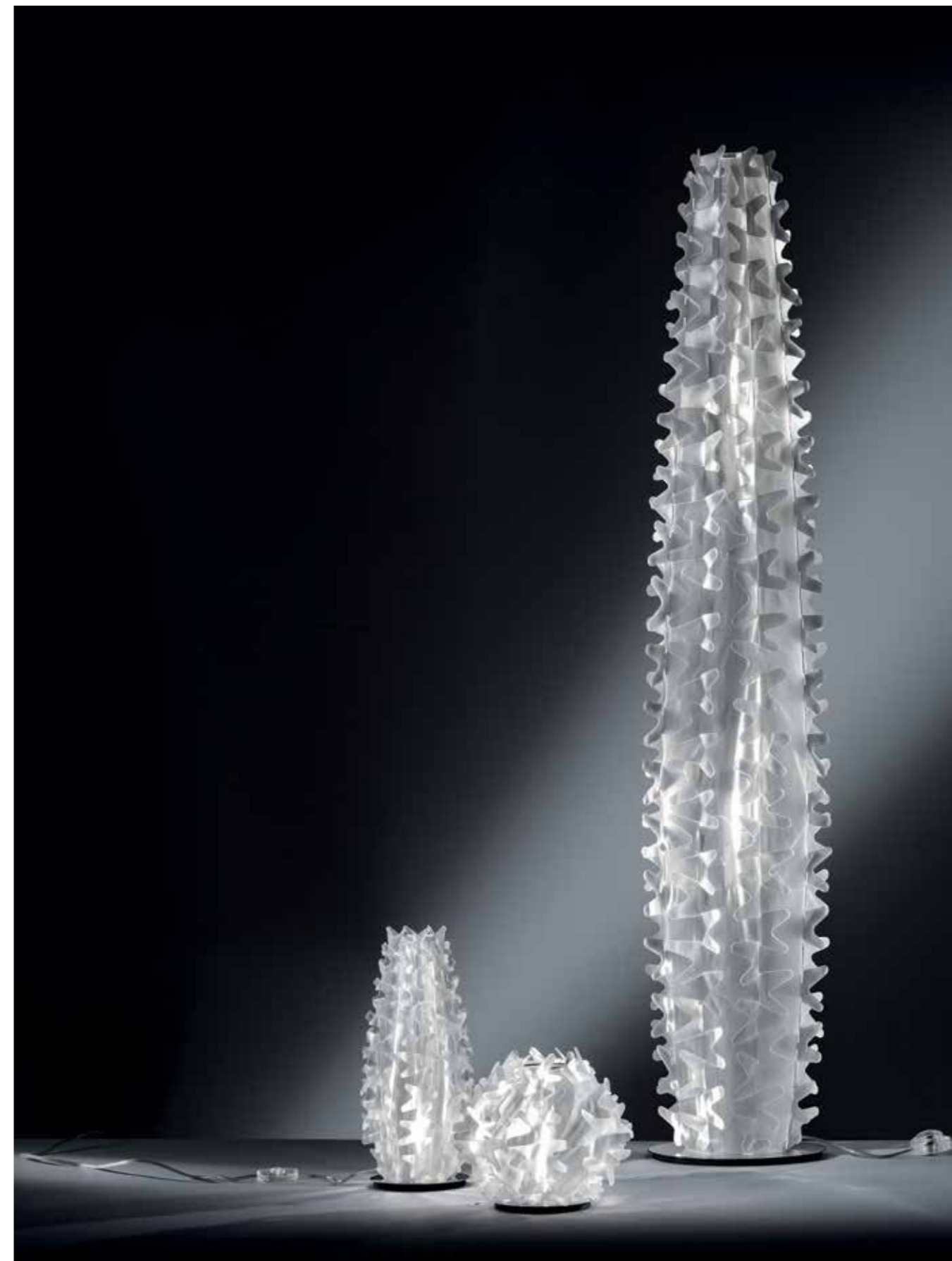



CACTUS PRISMA XL

FLOOR LAMP

Bulbs: 2 X 8W LED Filament - E27 or E26

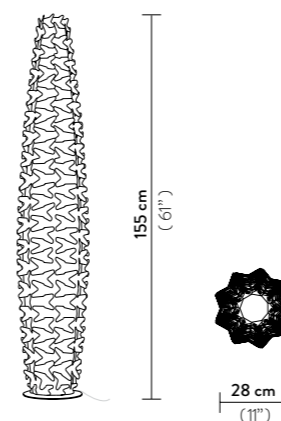

With: Stainless Steel Base

Made of: Opalflex®

CACTUS PRISMA XM

TABLE LAMP

Bulbs: 1 X 4W LED Filament - E14 or E12

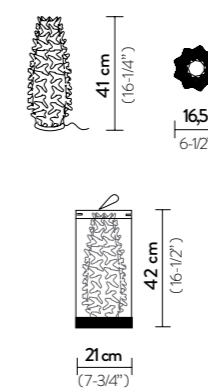

With: Stainless Steel Base

Made of: Opalflex®

CACTUS PRISMA XS

TABLE LAMP

Bulbs: 1 X 4W LED Filament - E14 or E12

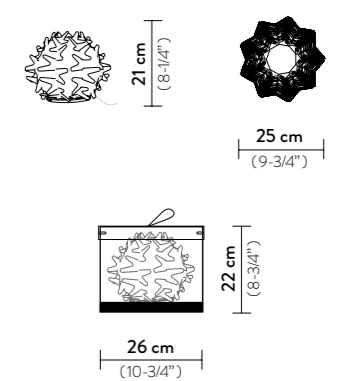

With: Stainless Steel Base

Made of: Opalflex®

Price List: page 67



PRISMA



FARETTO

BY NIGEL COATES

Una forma contemporanea, una geometria rigorosa, una linea rigida e penetrante che si ammorbidisce intorno a un cono centrale dove cerchi sovrapposti giocano con la luce senza perdere la direzione. Le linee di questa lampada si ispirano alle colline toscane e alla terra che, stratificandosi, crea paesaggi suggestivi. Grazie alle versioni suspension, double suspension e table, la collezione riesce trasversalmente a dar luce a ogni ambiente.

A modern shape, rigorous geometry, rigid and penetrating lines that soften around a central cone surrounded by layered rings that play with the light without losing form. The lamp's curves were inspired by the evocative rolling hills of the Tuscan countryside. The transversal collection adapts to any environment, and is available in suspension, double suspension and table versions.



FARETTO DOUBLE

SUSPENSION

Bulbs: 2 X 8W LED Filament - E27 or E26

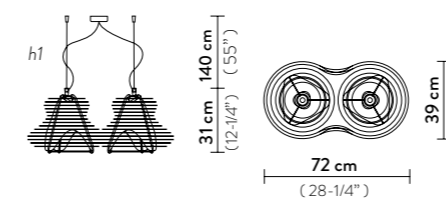

h1: maximum cable length

Made of: Plainflex® and Polycarbonate

FARETTO

SUSPENSION

Bulbs: 1 X 8W LED Filament - E27 or E26

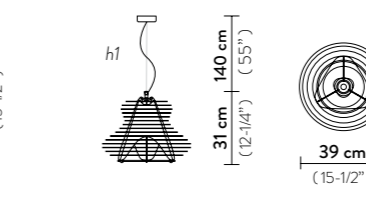

h1: maximum cable length

Made of: Plainflex® and Polycarbonate

FARETTO

TABLE LAMP

Bulbs: 1 X 8W LED Filament - E27 or E26

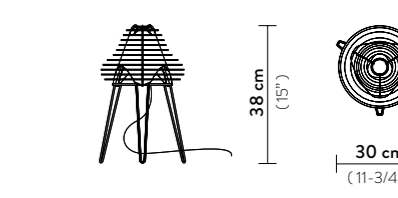

With: Dimmer Included

Made of: Plainflex®, Polycarbonate, Stainless Steel

Price List: page 72

BLACK WHITE



GOCCIA BY STEFANO PAPI

Il corpo luminoso, con il suo segno caratteristico, segue la forma fluida e leggera dell'acqua. Grazie ad un design unico, Goccia cela e rivela contemporaneamente la sua particolarità: la fonte luminosa. La lampada gioca con la luce regalando, sia nelle versioni prisma in Lentiflex® che nelle versioni colorate, effetti e riflessi straordinari. Liquida ma compatta, morbida e brillante, dona vivacità agli ambienti domestici e decora spazi ampi e sinuosi specialmente se usata in multipli.

The weightless, fluid form of liquid has been captured in this luminous body, and Goccia's unique design plays hide and seek with the central light source. Both the Lentiflex® and coloured versions have extraordinary, varying effects and reflections. Fluid yet compact, soft and shining, the lamp adds energy to domestic spaces and when grouped together in large areas, sinuous refinement.





Goccia Tetra

Goccia Jet

Goccia Snow

Goccia Aqua

Goccia Opal

Goccia Fire

Goccia Prisma

GOCCIA

SUSPENSION

Bulbs: 1X 8W LED Filament - E27 or E26

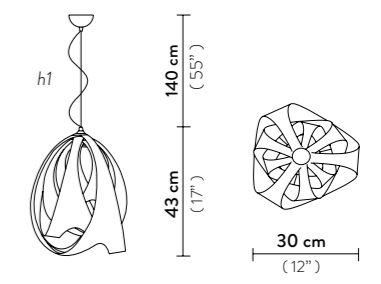

h1: maximum cable length

Made of: Lentiflex® or Opalflex®

PRISMA	AQUA	FIRE	OPAL
TETRA	JET	SNOW	

Price List: page 83

BATTISTA BY NIGEL COATES

Natura e tecnologia s'incontrano in questa scultura luminosa. La base di pioppo, ricavata da antiche travi riciclate, su cui poggia la struttura in Cristalflex®, delicatamente pennellata di bianco, fa di Battista un'installazione moderna e artistica. Attraverso il fascio di luce emanato dal suo corpo longilineo, arricchisce l'ambiente diffondendo e sprigionando tutto il suo carisma. I 300 pezzi in tiratura limitata testimoniano l'unicità di Battista, la cui cifra è impressa a fuoco sulla sua base in legno.

This luminous sculpture is a meeting of nature and technology. This modern and artistic installation has a base carved from antique poplar beams, supporting a Cristalflex® column delicately brushed with white textures. Light emanates from a vertical internal source that enriches a space, diffusing its carisma throughout. Battista is greatly unique, limited to only 300 pieces, each whose number is inscribed on the base.



BATTISTA

FLOOR LAMP

Bulbs: 1X16W Spot LED - E27 or E26

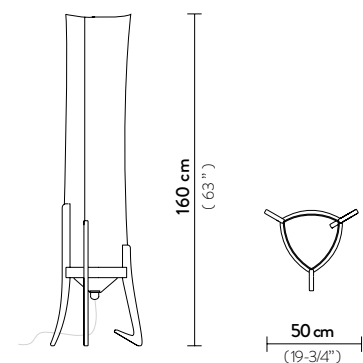

With: Signature by the Artist
Dimmer included

Made of: Cristalflex® / Reclaimed Wood Base

Price List: page 84

WHITE / FUMÉ



DAFNE BY NIGEL COATES

Il nome della lampada porta con sé l'immaginario mitico della trasformazione della Ninfa da donna in arbusto. Metamorfica, genera con la sua luce una sensazione di pace ed equilibrio: il segreto del suo fascino sta nel delicato decoro tono su tono, ispirato alla pianta di alloro. Adatta a rendere più accoglienti gli interior, è disponibile nelle versioni plafoniera, sospensione e nella versioni da terra e da tavolo.

From a nymph to a woman tuned into a tree; the myth and images that inspired the name. The metamorphic light instills a balanced, peaceful feeling that owes its mystique to a laurel-inspired tone on tone design. Daphne warms interiors, and is available in ceiling, suspension, floor and table versions.

DAFNE XL

FLOOR LAMP

Bulbs: 3 X 8W LED Filament - E27 or E26

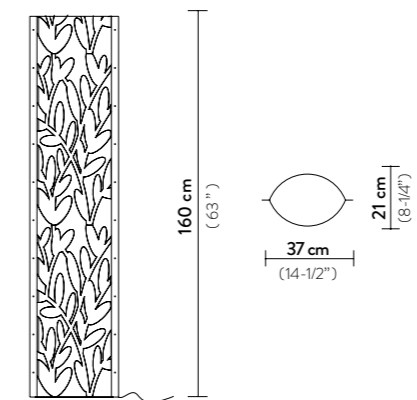

With: Aluminium Profiles - Dimmer Included

Made of: Opalflex®

Price List: page 90

DAFNE S

TABLE LAMP

Bulbs: 1 X 4W LED Filament - E14 or E12

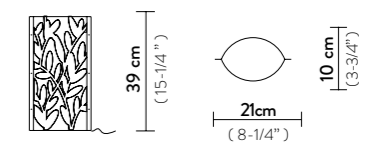

With: Aluminium Profiles - Dimmer Included

Made of: Opalflex®

HYPER-WHITE
EFFECT



GEMMY DAFNE

SUSPENSION

Bulbs: 1X 8W LED Filament - E27 or E26

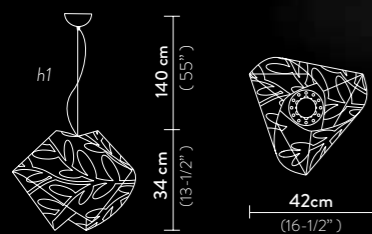

h1: maximum cable length

Made of: Opalflex®

Price List: page 90

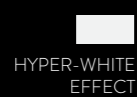

Plana Dafne

DAFNE L

CEILING / WALL LAMP

Bulbs: 4X 8W LED Filament - E27 or E26

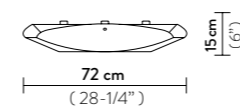

With: MagneticSystem®

Made of: Opalflex®

DAFNE M

CEILING / WALL LAMP

Bulbs: 3X 8W LED Filament - E27 or E26

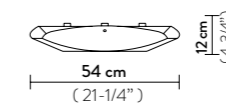

With: MagneticSystem®

Made of: Opalflex®

DAFNE S

CEILING / WALL LAMP

Bulbs: 2X 8W LED Filament - E27 or E26

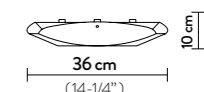

With: MagneticSystem®

Made of: Opalflex®

Price List: page 90

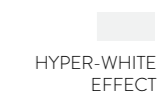

HYPER-WHITE EFFECT



HELIOS

BY SLAMP CREATIVE TEAM

Helios prende il suo nome dal dio greco del sole, si ispira a una cascata d'acqua e ne conserva la fluidità. Nel suo corpo, cilindrico e trasparente realizzato in metacrilato, la suggestione dell'acqua e la potenza della luce si incontrano e vengono sostenute da una nobile base in marmo di Carrara. L'interno della lampada si compone di Lentiflex® che, incontrando la luce dei LED, dà vita ad un effetto cromatico cangiante. Grazie al dimmer digitale è possibile ricreare ogni volta l'intensità luminosa preferita.

Named after the Greek sun god, Helios was inspired by the fluidity of a waterfall. Its transparent, cylindrical, methacrylate body rests on a Carrara marble base, harnessing the liquidity of light. The lamp's chromatic iridescence is thanks to LED technology enclosed in a Lentiflex® form. Its digital dimmer allows for the desired intensity of light in any space.



HELIOS

FLOOR LAMP

LED: 50W - 220 Vac or 120Vac / 24VDC
3.800 Lumen - 2700 Kelvin
CRI 90

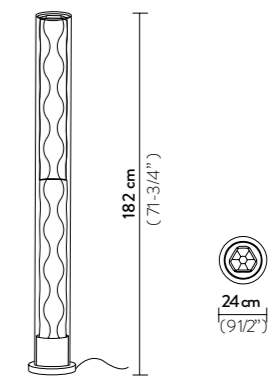

With: Carrara Marble Base - Dimmer Included

Made of: Lentiflex® and Metacrylate

Price List: page 77





GINETTA BY NIGEL COATES

Evoluzione digitale del classico candelieri a 8 bracci, sontuosa nella sua contemporaneità, Ginetta si sviluppa attorno a una fonte luminosa centrale e crea riflessi eleganti e raffinati. Si intona perfettamente alle location più attuali così come alle dimore più aristocratiche. Disponibile sia nelle versioni in Opalflex® che Metal e Prisma®, con cilindro diffusore in policarbonato iridescente.

A classic 8-arm chandelier underwent digital evolution; Ginetta's sumptuous modern shape extends from a central light source that casts elegant, refined reflections, blending into both modern and aristocratic atmospheres. The cylindrical diffuser in iridescent polycarbonate is surrounded by the option of three finishes; Metal, Prisma® or Opalflex®.



GINETTA

SUSPENSION

Bulbs: 1X8W LED Filament - E27 or E26

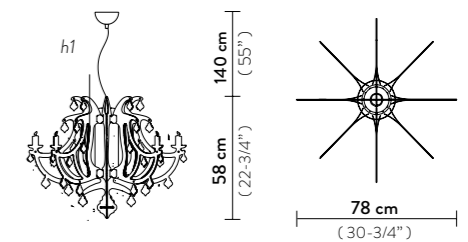

h1: maximum cable length

Made of: Opalflex® and Cristalflex® or Steelflex®

Price List: page 75

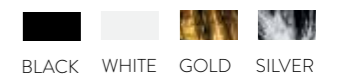

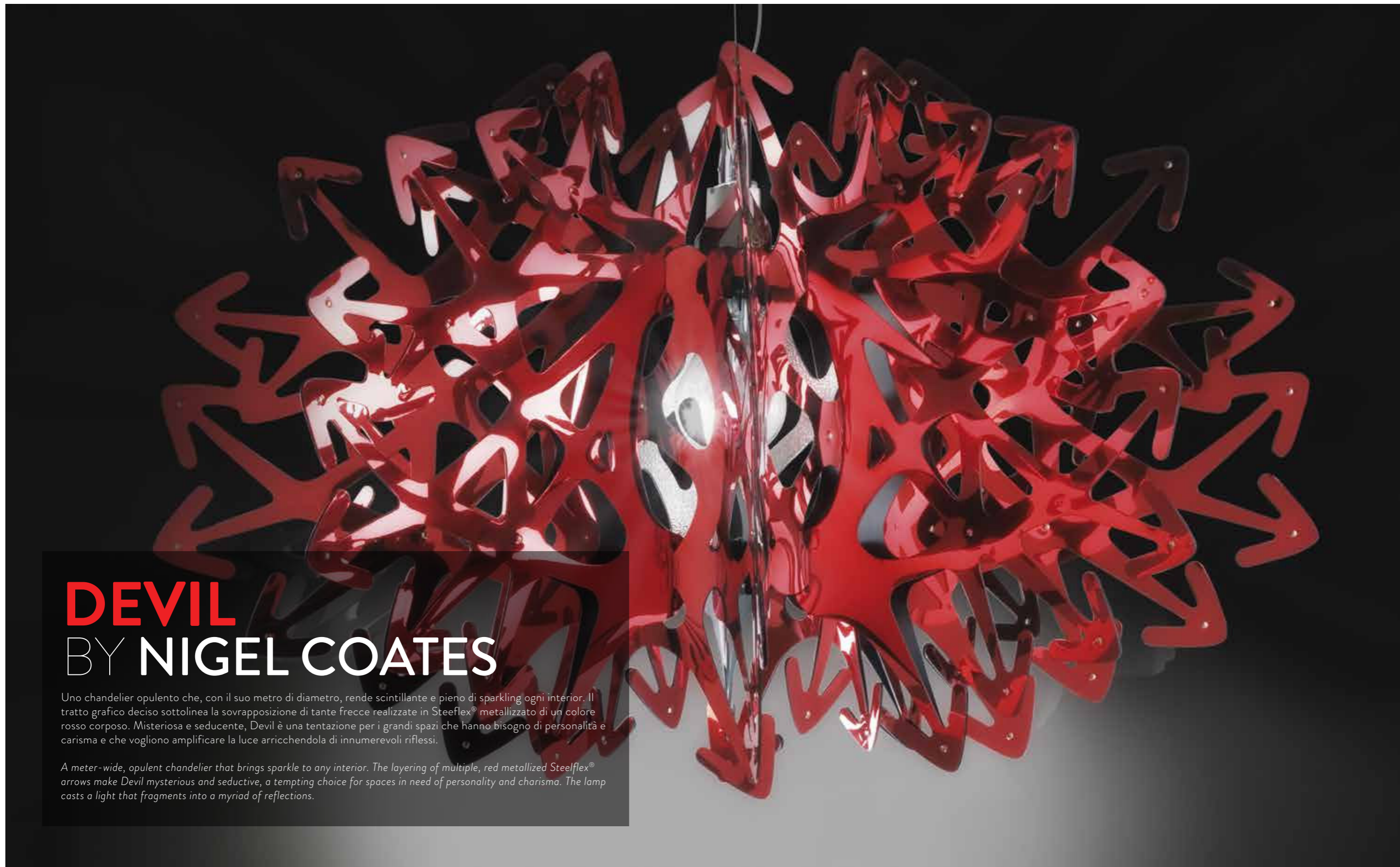

DEVIL BY NIGEL COATES

Uno chandelier opulento che, con il suo metro di diametro, rende scintillante e pieno di sparkling ogni interior. Il tratto grafico deciso sottolinea la sovrapposizione di tante frecce realizzate in Steelflex® metallizzato di un colore rosso corposo. Misteriosa e seducente, Devil è una tentazione per i grandi spazi che hanno bisogno di personalità e carisma e che vogliono amplificare la luce arricchendola di innumerevoli riflessi.

A meter-wide, opulent chandelier that brings sparkle to any interior. The layering of multiple, red metallized Steelflex® arrows make Devil mysterious and seductive, a tempting choice for spaces in need of personality and charisma. The lamp casts a light that fragments into a myriad of reflections.



DEVIL

SUSPENSION

Bulbs: 1 X 10W R7S LED

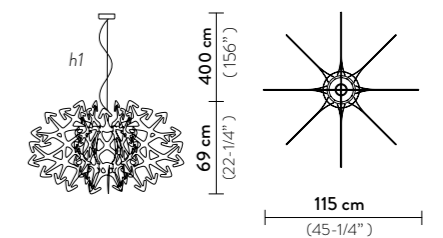

h1: maximum cable length

Made of: Steelflex®

Price List: page 85



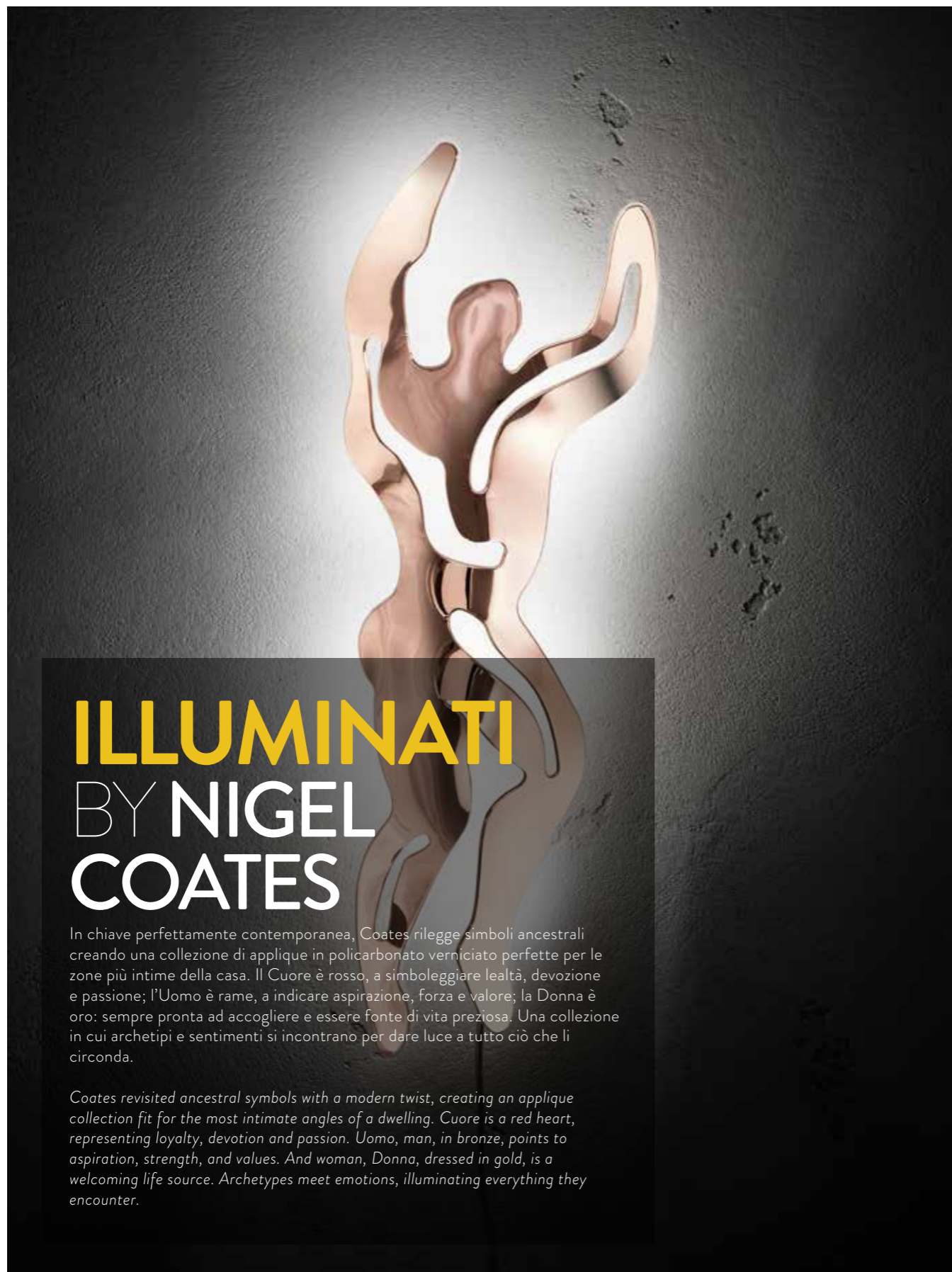

ILLUMINATI BY NIGEL COATES

In chiave perfettamente contemporanea, Coates rilegge simboli ancestrali creando una collezione di applique in policarbonato verniciato perfette per le zone più intime della casa. Il Cuore è rosso, a simboleggiare lealtà, devozione e passione; l'Uomo è rame, a indicare aspirazione, forza e valore; la Donna è oro: sempre pronta ad accogliere e essere fonte di vita preziosa. Una collezione in cui archetipi e sentimenti si incontrano per dare luce a tutto ciò che li circonda.

Coates revisited ancestral symbols with a modern twist, creating an applique collection fit for the most intimate angles of a dwelling. Cuore is a red heart, representing loyalty, devotion and passion. Uomo, man, in bronze, points to aspiration, strength, and values. And woman, Donna, dressed in gold, is a welcoming life source. Archetypes meet emotions, illuminating everything they encounter.

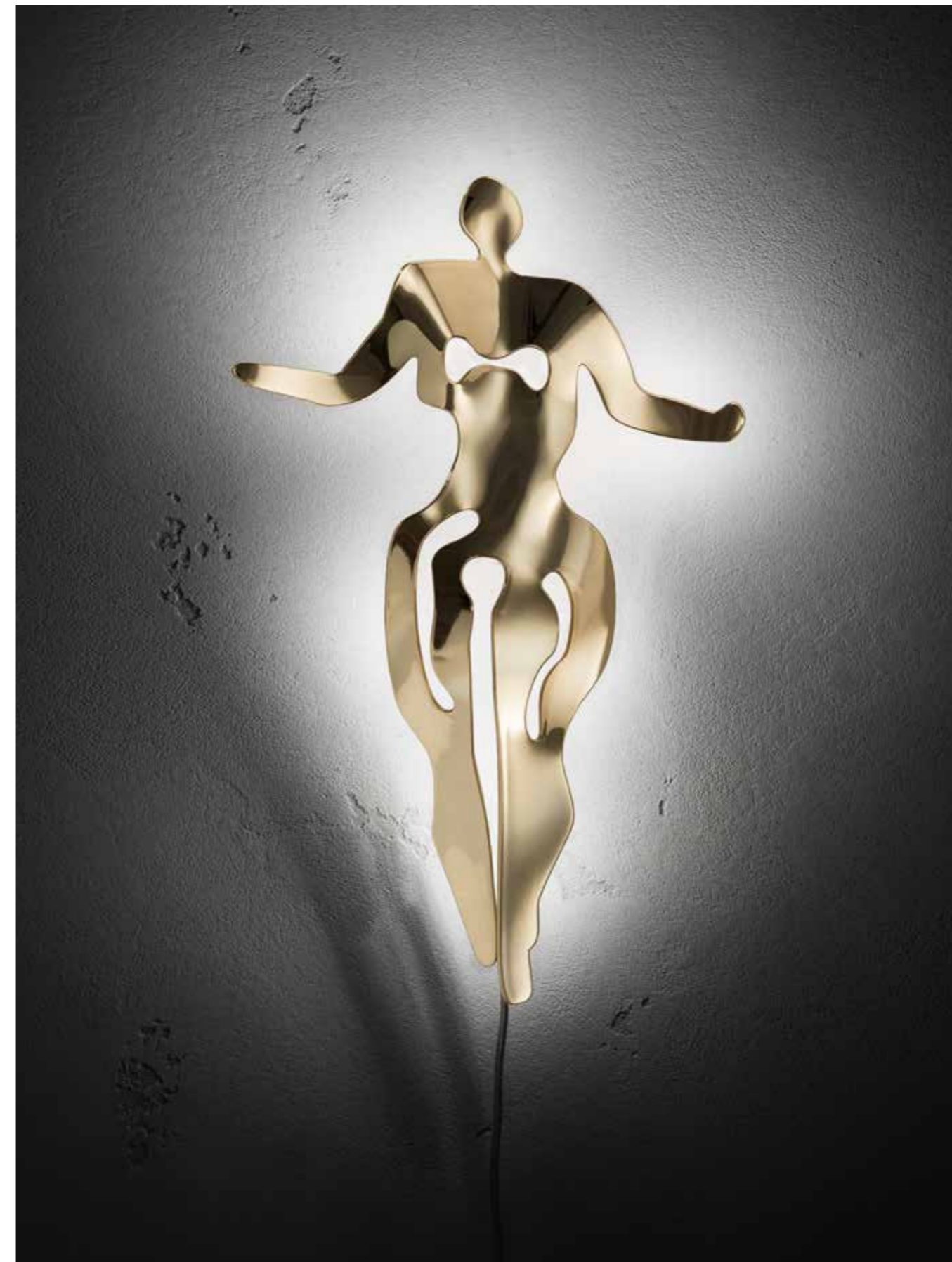



Cuore



Uomo



Donna

CUORE

WALL LAMP

LED: 8W - 220 Vac or 120Vac / 12Vdc
600 Lumen - 2700 Kelvin

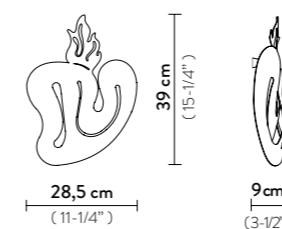

Made of: Plainflex®

Price List: page 80



RED

UOMO

WALL LAMP

LED: 6,5W - 220Vac or 120Vac / 12Vdc
500 Lumen - 2700 Kelvin

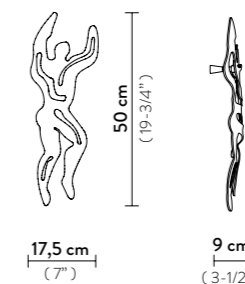

Made of: Plainflex® Bronze Plated



BRONZE

DONNA

WALL LAMP

LED: 6W - 220Vac or 120Vac / 12Vdc
450 Lumen - 2700 Kelvin

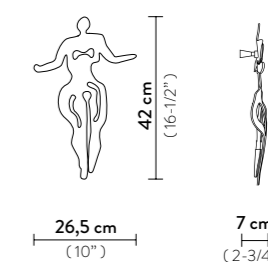

Made of: Plainflex® Gold Plated



GOLD



MEDUSA BY NIGEL COATES

Medusa e Lilibet sono collezioni fortemente scenografiche che hanno segnato un momento di grande evoluzione stilistica nella produzione di Slamp. Realizzate prevedendo una struttura radiale che si aggancia facilmente al cestello centrale in Opalflex®, Medusa e Lilibet, sono arricchite dalla preziosità dei cristalli trasparenti che riflettono la luce dalla sorgente luminosa creando riflessioni multiformi nell'ambiente circostante.

Medusa and Lilibet are dramatic collections that marked Slamp's evolution of stylistic production. The radial structure easily connects to the central Opalflex® cylinder, that reflects the added luxury of transparent crystals. Both Medusa and Lilibet, cast multiple fragments of light.



MEDUSA

SUSPENSION

Bulbs: 1X 8W LED Filament - E27 or E26

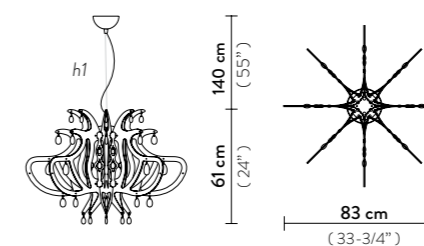

h1: maximum cable length

With: 56 Swarovski® Crystals

Made of: Opalflex® or Cristalflex®

Price List: page 70



WALL LAMP

Bulbs: 1X 8W LED Filament - E27 or E26

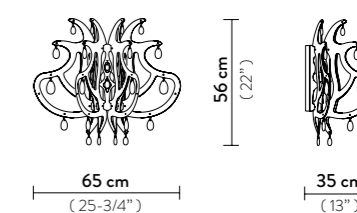

h1: maximum cable length

With: 26 Swarovski® Crystals

Made of: Opalflex® or Cristalflex®





LILLIBET
BY NIGEL COATES



LILLIBET

SUSPENSION

Bulbs: 1X 8W LED Filament - E27 or E26

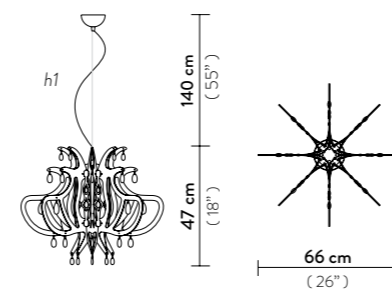

h1: maximum cable length

With: 56 Schöler Crystals
Ceiling rose matching colour

Made of: Opalflex® or Cristalflex® or Goldflex®
or Steelflex® or Copperflex®

Price List: page 71



LILLIBET MINI

SUSPENSION

Bulbs: 1X 4W LED Filament - E14 or E12

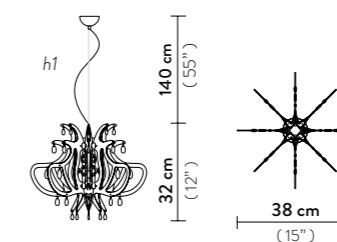

h1: maximum cable length

With: 42 Schöler Crystals
Ceiling rose matching colour

Made of: Opalflex® or Cristalflex® or Goldflex®
or Steelflex® or Copperflex®

Price List: page 71

LILLIBET MINI

WALL LAMP

Bulbs: 1X 4W LED Filament - E14 or E12

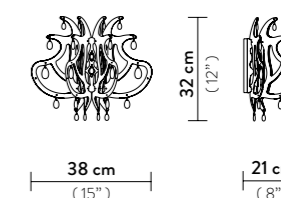

With: 36 Schöler Crystals
Ceiling rose matching colour

Made of: Opalflex® or Cristalflex® or Goldflex®
or Steelflex® or Copperflex®



ATLANTE BY NIGEL COATES

Costretto da Zeus a tenere sulle spalle l'intera volta celeste e descritto poeticamente nell'Odissea come uno dei pilastri del cielo, Atlante ispira il design forte e contemporaneo di questa lampada, legato tanto all'universo quanto alle forme di vita ultraterrene. Realizzato in Cristalflex® con una leggera sfumatura tortora, il suo ambiente terrestre è tra i libri di pittura e racconti di viaggio, tra album di fotografie e progetti di architettura.

The Odyssey described him as one of those chosen to hold up the sky for all eternity, a titan selected by Zeus: Atlas inspired this lamp's strong, modern design, tied to all that is beyond this universe. Made of Cristalflex® shaded slightly in beige, Atlante's earthly home is amongst vintage books, slides of world travels, and architectural sketches.



ATLANTE

SUSPENSION

Bulbs: 8 X 15W max IBC/C - E14 or E12

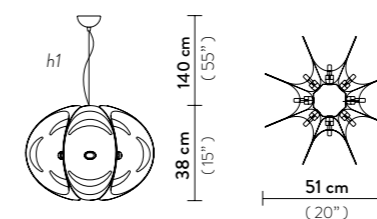

h1: maximum cable length

Made of: Cristalflex®

FLOOR LAMP

Bulbs: 8 X 15W max IBC/C - E14 or E12

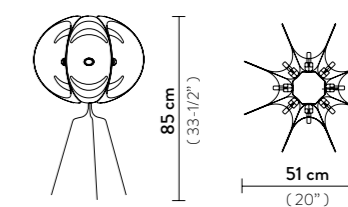

With: Stainless Steel Legs

Made of: Cristalflex®

Price List: page 92



FUMÉ

SUPER MORGANA BY STEFANO PAPI

Splendida e leggendaria, ammalia con le sue forme che richiamano alambicchi ed ampolle. Una lampada alchemica capace di rendere magica se stessa e tutto ciò che la circonda. Anche il filo quasi invisibile a cui è appesa sembra frutto di un incantesimo, simile a quello che crea se la si osserva dal basso: in questa prospettiva, infatti, ricorda il rosone di Piazza del Campidoglio a Roma.

Legendary, splendid, and captivating, with a shape that conjures up images of an alchemist's vials, this lamp brings a touch of magic to any interior. Its almost invisible cable adds to the enchantment, and when seen from below, it resembles the rosette in Rome's Piazza di Campidoglio.



SUPERMORGANA

SUSPENSION

Bulbs: 1 X 2W LED - G9

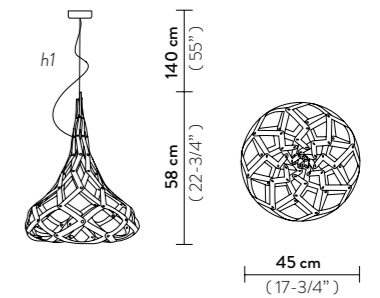

h1: maximum cable length

Made of: Metallized Polycarbonate

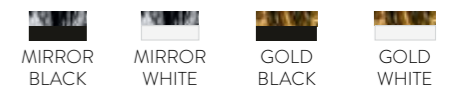

Price List: page 79

MILLE BOLLE BY ADRIANO RACHELE

L'emozione fugace delle bolle di sapone, i ricordi di un passato mai troppo lontano, un romantico gioco di luci e preziosi riflessi senza tempo. Il fascino del diffusore, realizzato a mano piegando ad arte piccoli fogli di policarbonato iridescente, si accende sotto una fonte luminosa quasi invisibile generando un'ampia collezione (wall, floor, table e suspension) che incanta l'osservatore grazie al suo design e ai suoi giochi di riflessi e rifrazione.

Soap bubbles, fleeting emotions from the near past captured in a romantic, timeless play of light and weightless reflections. The handcrafted diffuser is a series of small, folded iridescent polycarbonate pieces, illuminated by an almost invisible light source. The ample collection (wall, floor, table, and suspension) enchants the onlooker with its design and varied refractions.



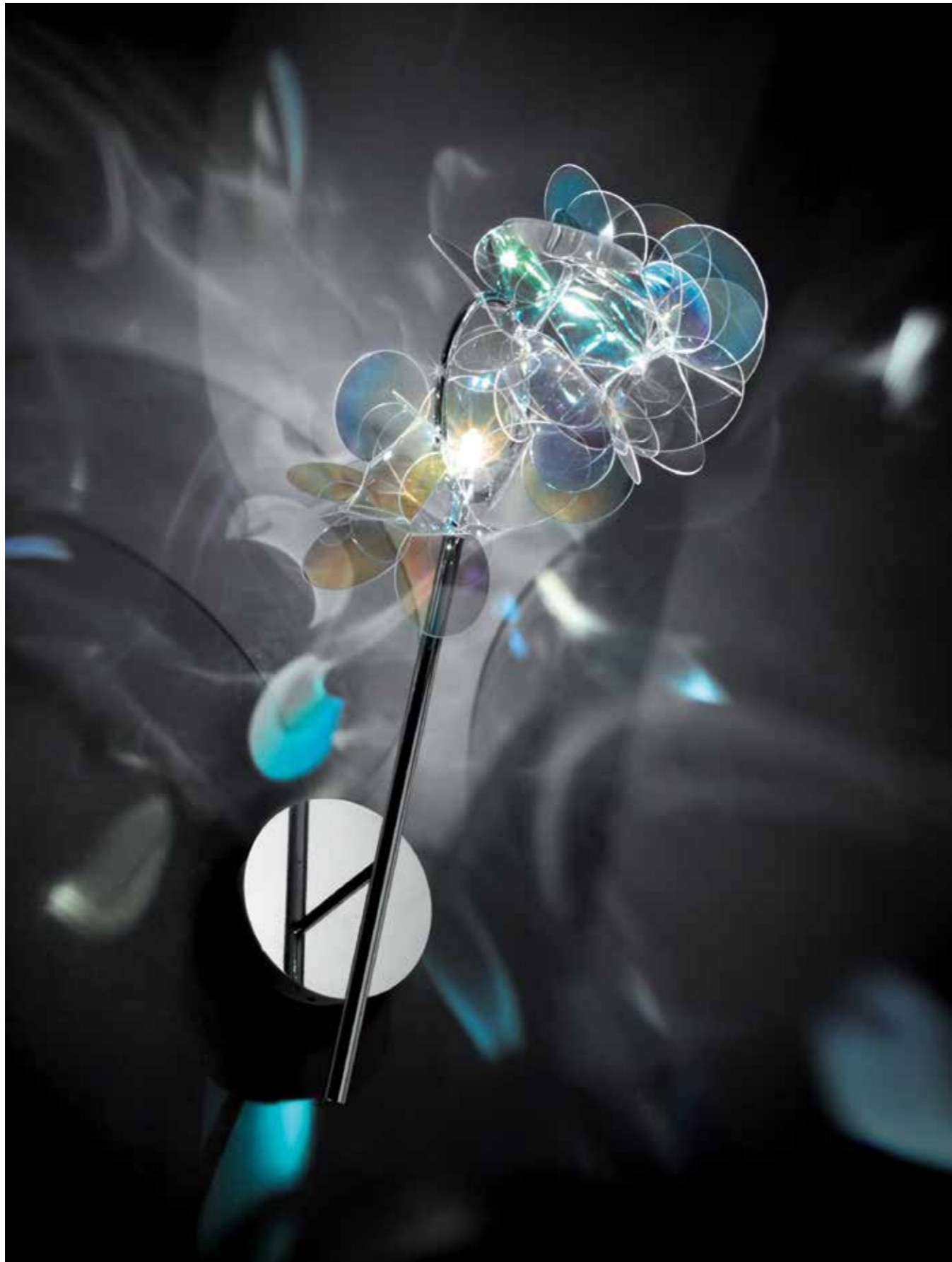

Mille Bolle
Suspension

MILLE BOLLE

SUSPENSION

Bulbs: 1 X 2W LED - G9

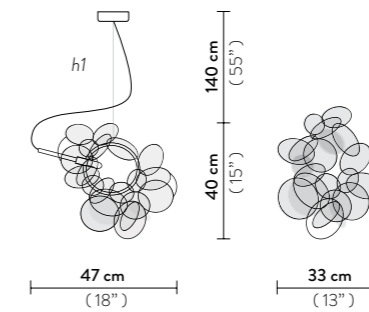

h1: maximum cable length

With: Stainless Steel Structure

Made of: Iridescent Polycarbonate

WALL LAMP

Bulbs: 1 X 3W LED - G4

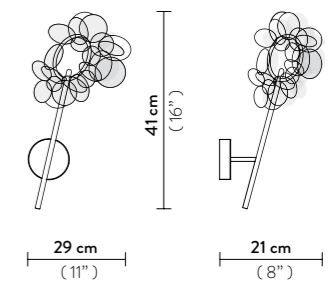

With: Stainless Steel Structure

Made of: Iridescent Polycarbonate

TABLE LAMP

Bulbs: 1 X 3W LED - G4

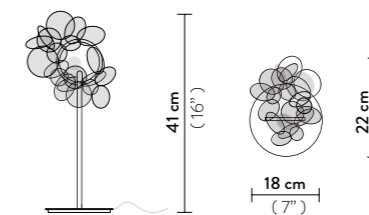

With: Stainless Steel Structure

Made of: Iridescent Polycarbonate

FLOOR LAMP

Bulbs: 1 X 3W LED - G9

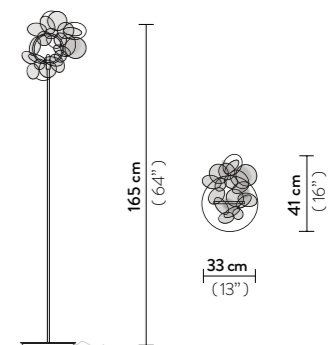

With: Stainless Steel Structure

Made of: Iridescent Polycarbonate

Price List: page 76



IRIDESCENT



VENTI BY ALESSANDRO MENDINI

Come un sasso gettato nell'acqua, il decoro che la caratterizza genera linee morbide e regolari: cerchi concentrici, sempre più grandi, in corrispondenza delle fonti luminose. Le colorazioni neutre tono su tono delle versioni floor, table e wall avvolgono la lampada guidando le vibrazioni della luce, che trasmette un'atmosfera calma e rilassata, delicata e regolare come la marea, capace di adattarsi e arricchire ogni interior.

Like a stone thrown into water, the lamp's lines are soft and uniform; concentric circles that surround the central light sources radiate outwards. The tonal shades guide the lamps vibrations, instilling a calm and relaxed environment. The floor, table and wall versions are delicate and regular like the sea, adapting themselves to any interior.

VENTI XL

FLOOR LAMP

Bulbs: 3 X 8W LED Filament - E27 or E26

VENTI S

TABLE LAMP

Bulbs: 1 X 4W LED Filament - E14 or E12

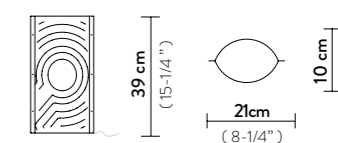
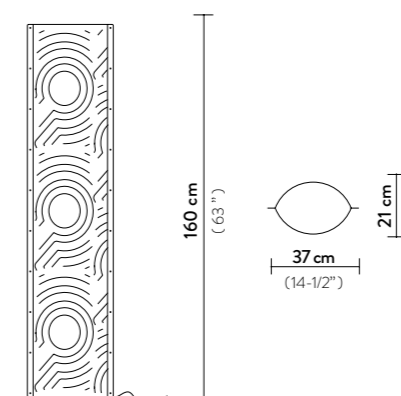

With: Aluminium Profiles - Dimmer Included

Made of: Opalflex®

With: Aluminium Profiles - Dimmer Included

Made of: Opalflex®

Price List: page 88

HYPER-WHITE
EFFECT

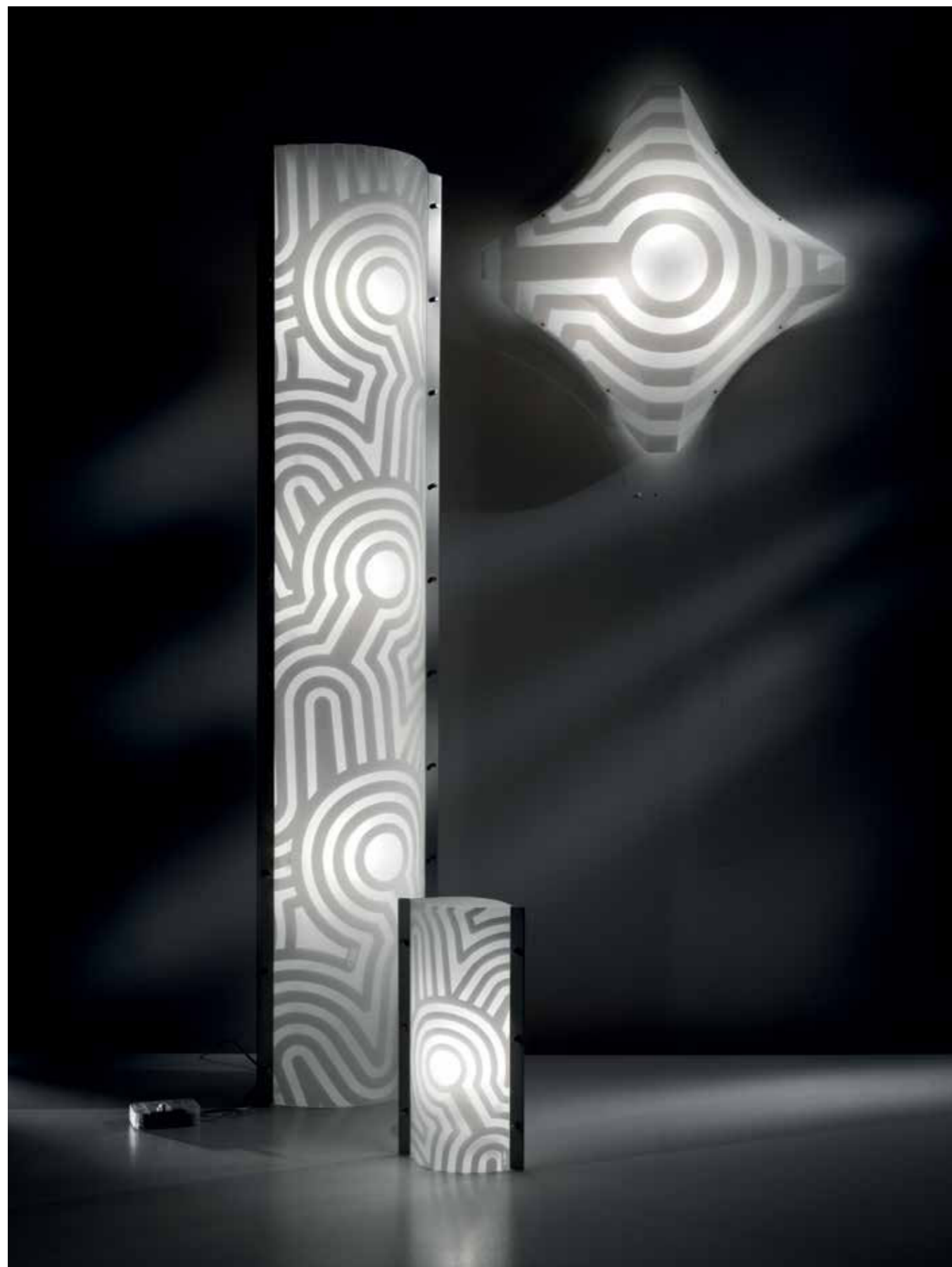

VENTI L

CEILING / WALL LAMP

Bulbs: 4 X 8W LED Filament - E27 or E26

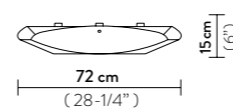

With: MagneticSystem®

Made of: Opalflex®

VENTI M

CEILING / WALL LAMP

Bulbs: 3 X 8W LED Filament - E27 or E26

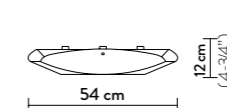

With: MagneticSystem®

Made of: Opalflex®

VENTI S

CEILING / WALL LAMP

Bulbs: 2 X 8W LED Filament - E27 or E26

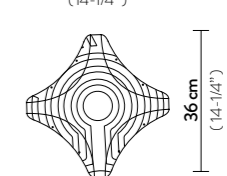
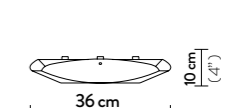

With: MagneticSystem®

Made of: Opalflex®

Price List: page 88

HYPER-WHITE EFFECT



CHAPEAU BY NIGEL COATES

Design contemporaneo, ricco di carattere dinamico e attraente. L'interno è specchiato, avvolto in uno strato nero, per creare una rifrazione particolarmente elegante della luce, sia verso il basso sia verso il soffitto. Disponibile nelle versioni floor, suspension e table, Chapeau è un complemento d'arredo originale e funzionale per ricreare atmosfere intime e di raccoglimento.

A modern design rich in dynamic character. The mirrored inside is enveloped by a black layer, creating particularly elegant refractions of light that extend above and below the lamp. Chapeau is available in floor, suspension, and table versions, and is the perfect original yet functional accessory to create an intimate, welcoming atmosphere.

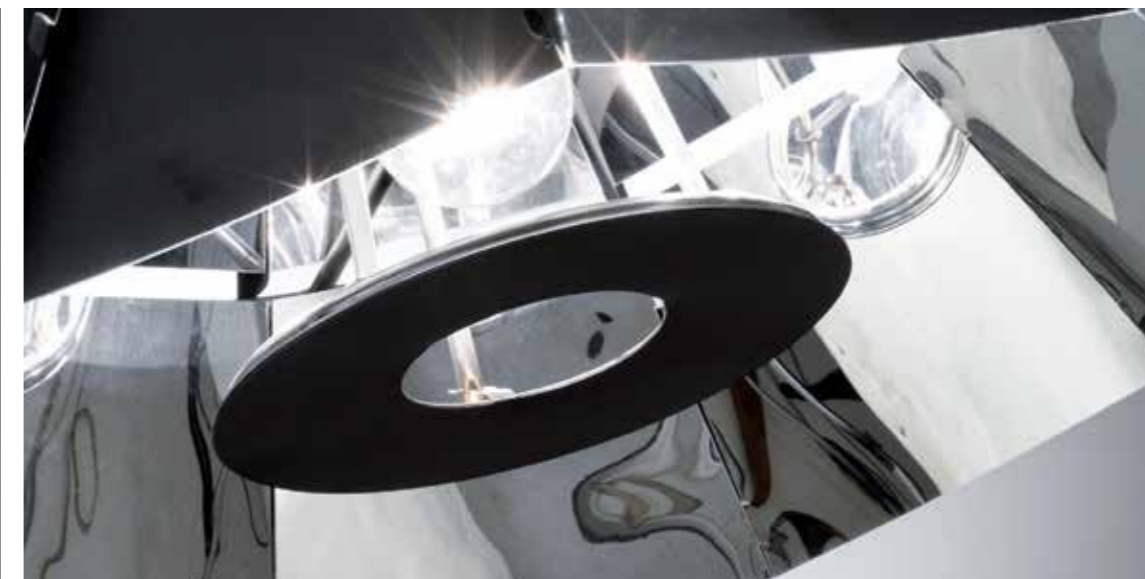

Da sinistra in senso orario: Chapeau Table; dettaglio della superficie specchiata all'interno del cappello della sospensione; vista dal basso della sospensione; Chapeau floor.

Clockwise from the left: Chapeau Table; close-up of the internal, mirrored surface of Chapeau suspension; bottom view of the suspension; Chapeau floor.



CHAPEAU

SUSPENSION

Bulbs: 1X8W LED Filament - E27 or E26

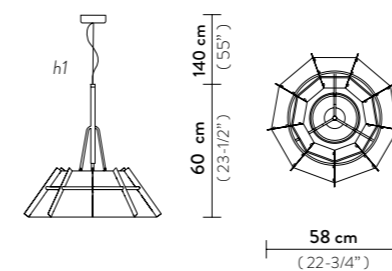

h1: maximum cable length

Made of: Polycarbonate / Stainless Steel

TABLE LAMP

Bulbs: 1X4W LED Filament - E14 or E12

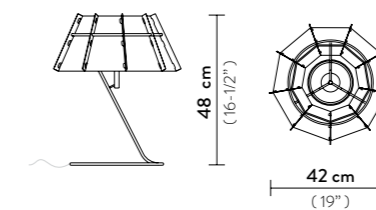

With: Dimmer included

Made of: Polycarbonate / Stainless Steel

FLOOR LAMP

Bulbs: 1X8W LED Filament - E27 or E26

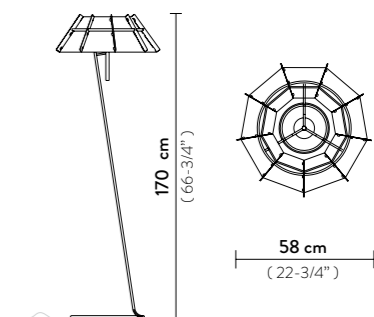

With: Dimmer included

Made of: Polycarbonate / Stainless Steel

Price List: page 82

MIRROR
BLACK

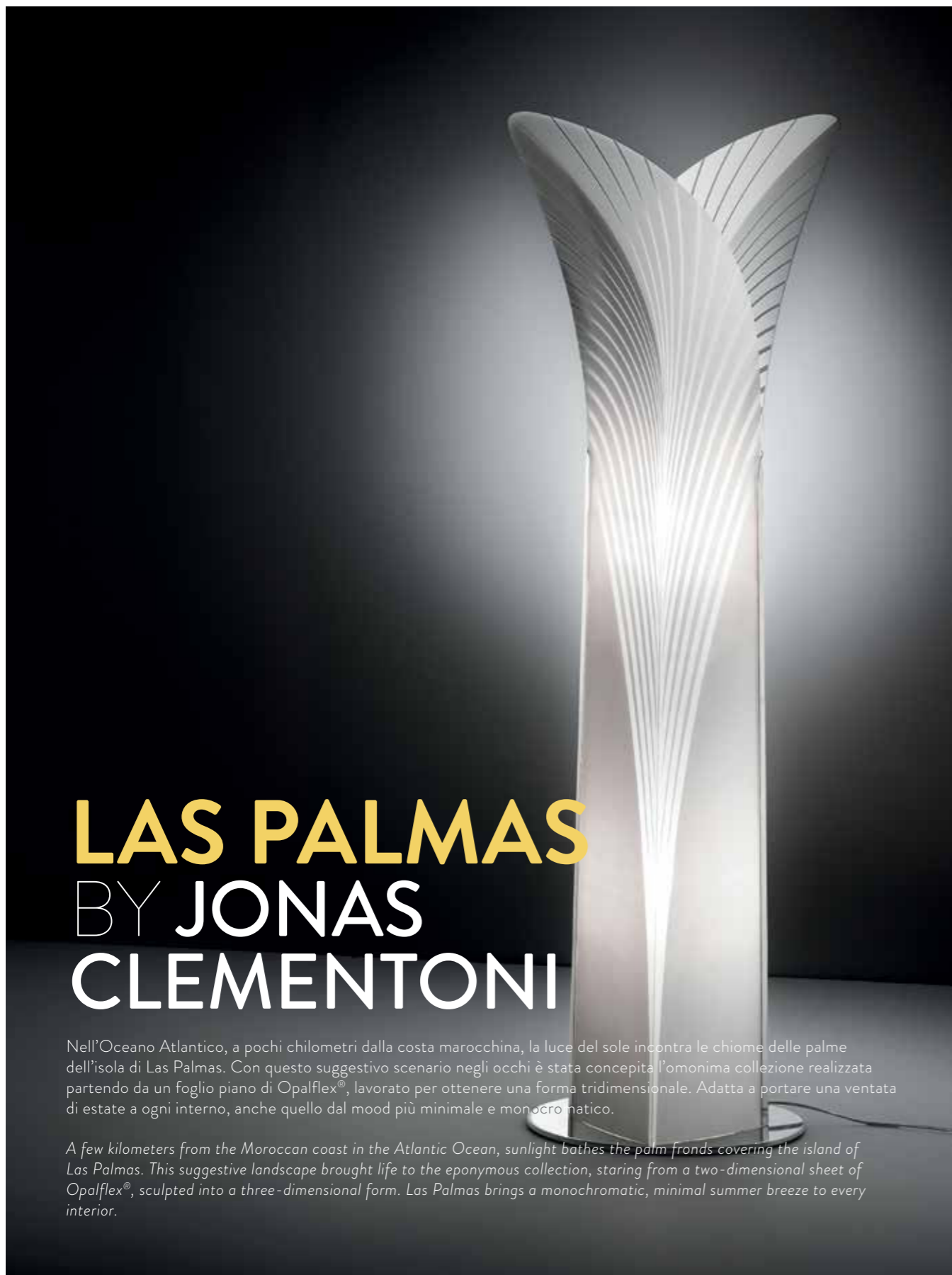

LAS PALMAS BY JONAS CLEMENTONI

Nell'Oceano Atlantico, a pochi chilometri dalla costa marocchina, la luce del sole incontra le chiome delle palme dell'isola di Las Palmas. Con questo suggestivo scenario negli occhi è stata concepita l'omonima collezione realizzata partendo da un foglio piano di Opalflex®, lavorato per ottenere una forma tridimensionale. Adatta a portare una ventata di estate a ogni interno, anche quello dal mood più minimale e monocromatico.

A few kilometers from the Moroccan coast in the Atlantic Ocean, sunlight bathes the palm fronds covering the island of Las Palmas. This suggestive landscape brought life to the eponymous collection, starting from a two-dimensional sheet of Opalflex®, sculpted into a three-dimensional form. Las Palmas brings a monochromatic, minimal summer breeze to every interior.



LAS PALMAS XL

FLOOR LAMP

Bulbs: 3 X 8W LED Filament - E27 or E26

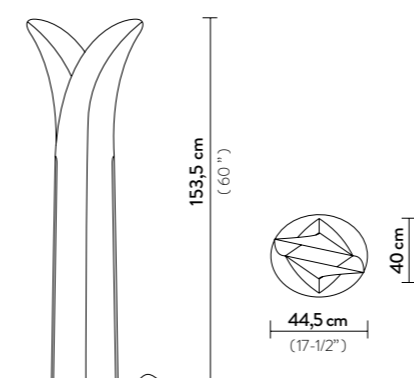

With: Stainless Steel base and profile

Made of: Opalflex® / Polycarbonate

LAS PALMAS L

FLOOR LAMP

Bulbs: 2 X 8W LED Filament - E27 or E26

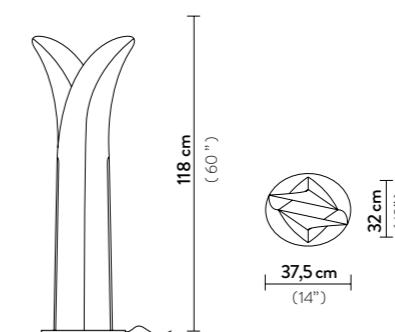

With: Stainless Steel base and profile

Made of: Opalflex® / Polycarbonate

LAS PALMAS S

TABLE LAMP

Bulbs: 1 X 4W LED Filament - E14 or E12

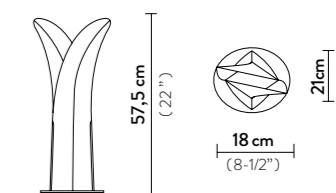

With: Stainless Steel base and profile

Made of: Opalflex® / Polycarbonate

Price List: page 94

WHITE

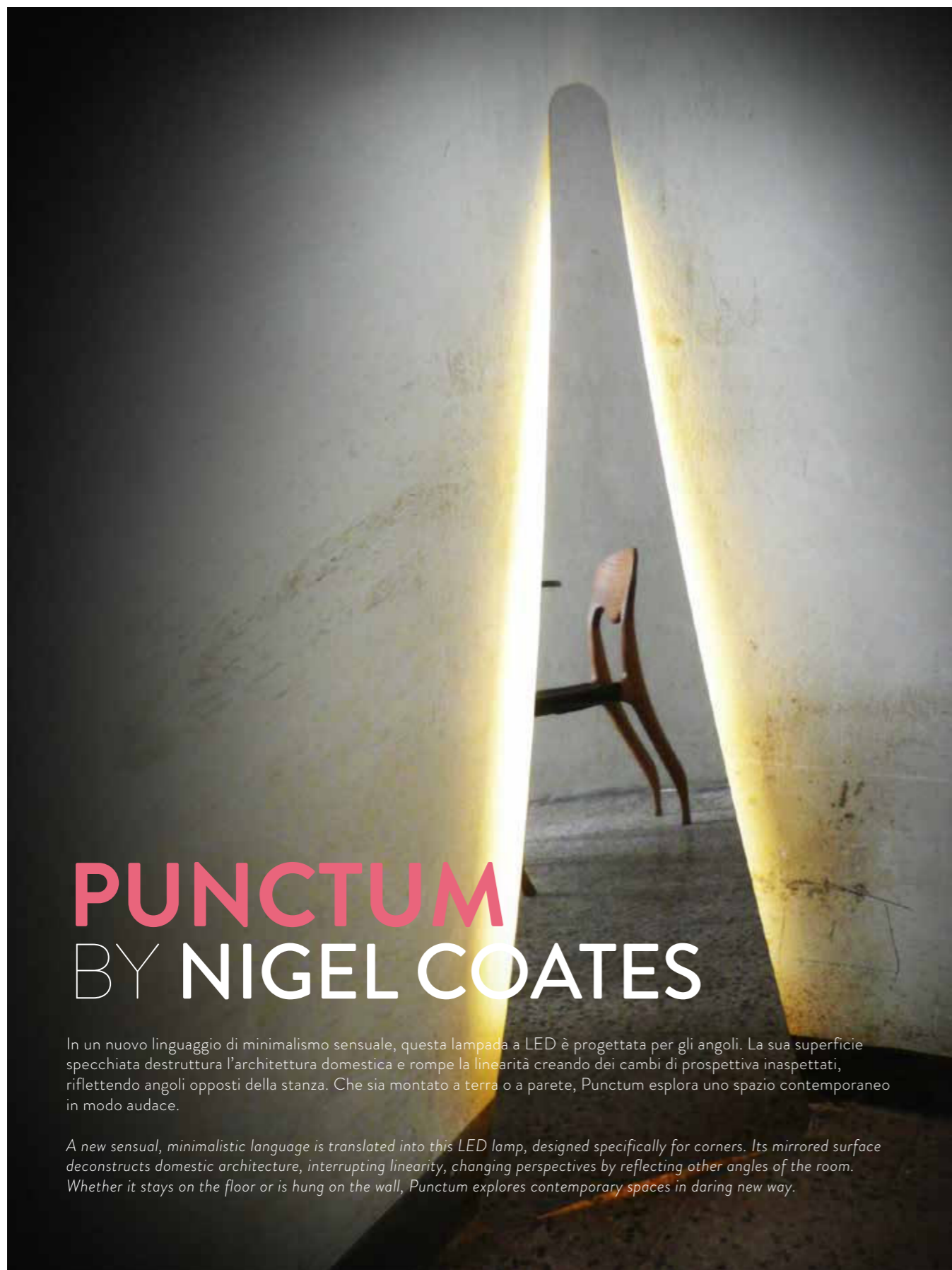

PUNCTUM

BY NIGEL COATES

In un nuovo linguaggio di minimalismo sensuale, questa lampada a LED è progettata per gli angoli. La sua superficie specchiata destruttura l'architettura domestica e rompe la linearità creando dei cambi di prospettiva inaspettati, riflettendo angoli opposti della stanza. Che sia montato a terra o a parete, Punctum esplora uno spazio contemporaneo in modo audace.

A new sensual, minimalistic language is translated into this LED lamp, designed specifically for corners. Its mirrored surface deconstructs domestic architecture, interrupting linearity, changing perspectives by reflecting other angles of the room. Whether it stays on the floor or is hung on the wall, Punctum explores contemporary spaces in daring new way.

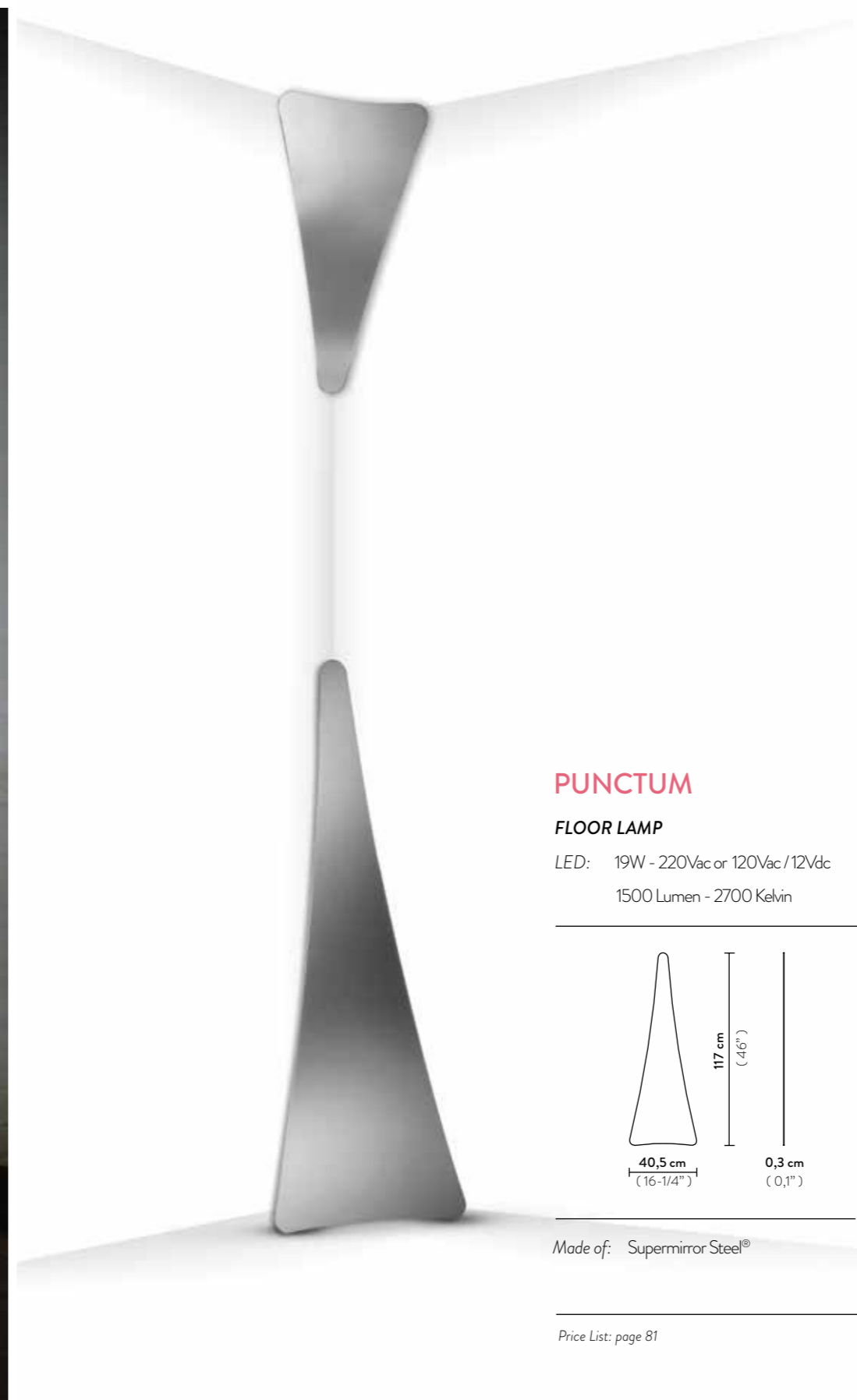

PUNCTUM

FLOOR LAMP

LED: 19W - 220Vac or 120Vac / 12Vdc
1500 Lumen - 2700 Kelvin

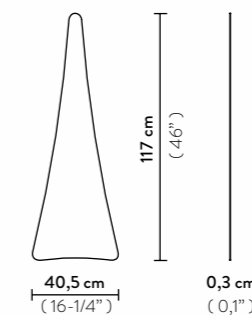

Made of: Supermirror Steel®

WALL LAMP

LED: 12W - 220Vac or 120Vac / 12Vdc
1000 Lumen - 2700 Kelvin

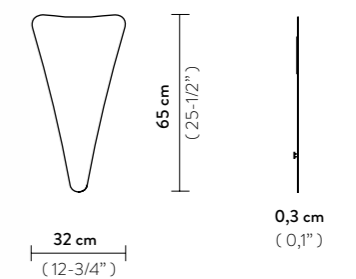

With: MagneticSystem®

Made of: Supermirror Steel®

Price List: page 81



GEMMY

BY SPALLETTA, CROCE RAGNISCO, WIJFFELS

Dinamica e versatile, la collezione ispirata alle preziose gemme desertiche, con le sue poliedriche sfaccettature, avvolge geometricamente la luce e genera intriganti effetti caleidoscopici, capaci di arricchire con carattere ogni interior dal gusto moderno e ricercato. La varietà della gamma, in termini di forme e colori, fa di Gemmy una lampada versatile in grado di definire adeguarsi, senza invadenza, agli interni più contemporanei.

This versatile and dynamic collection was inspired by the polyhedral facets of desert gems. The lamp's geometries create an intriguing contemporary and refined kaleidoscope effect that enriches any interior. The Gemmy collection includes a vast range of colours that adapt seamlessly to any modern space.



GEMMY PRISMA

SUSPENSION

Bulbs: 1X 8W LED Filament - E27 or E26

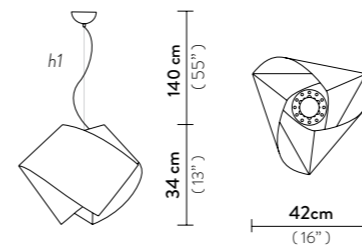

h1: maximum cable length

Made of: Lentiflex®

TABLE LAMP

Bulbs: 1X 4W LED Filament - E14 or E12

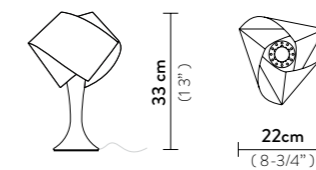

With: White Steel Base

Made of: Lentiflex®

FLOOR LAMP

Bulbs: 1X 8W LED Filament - E27 or E26

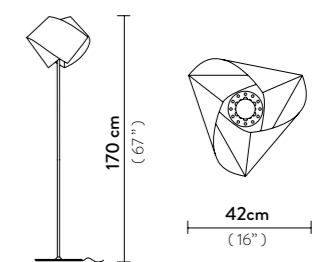

With: White steel Base and Stem

Made of: Lentiflex®

Price List: page 64



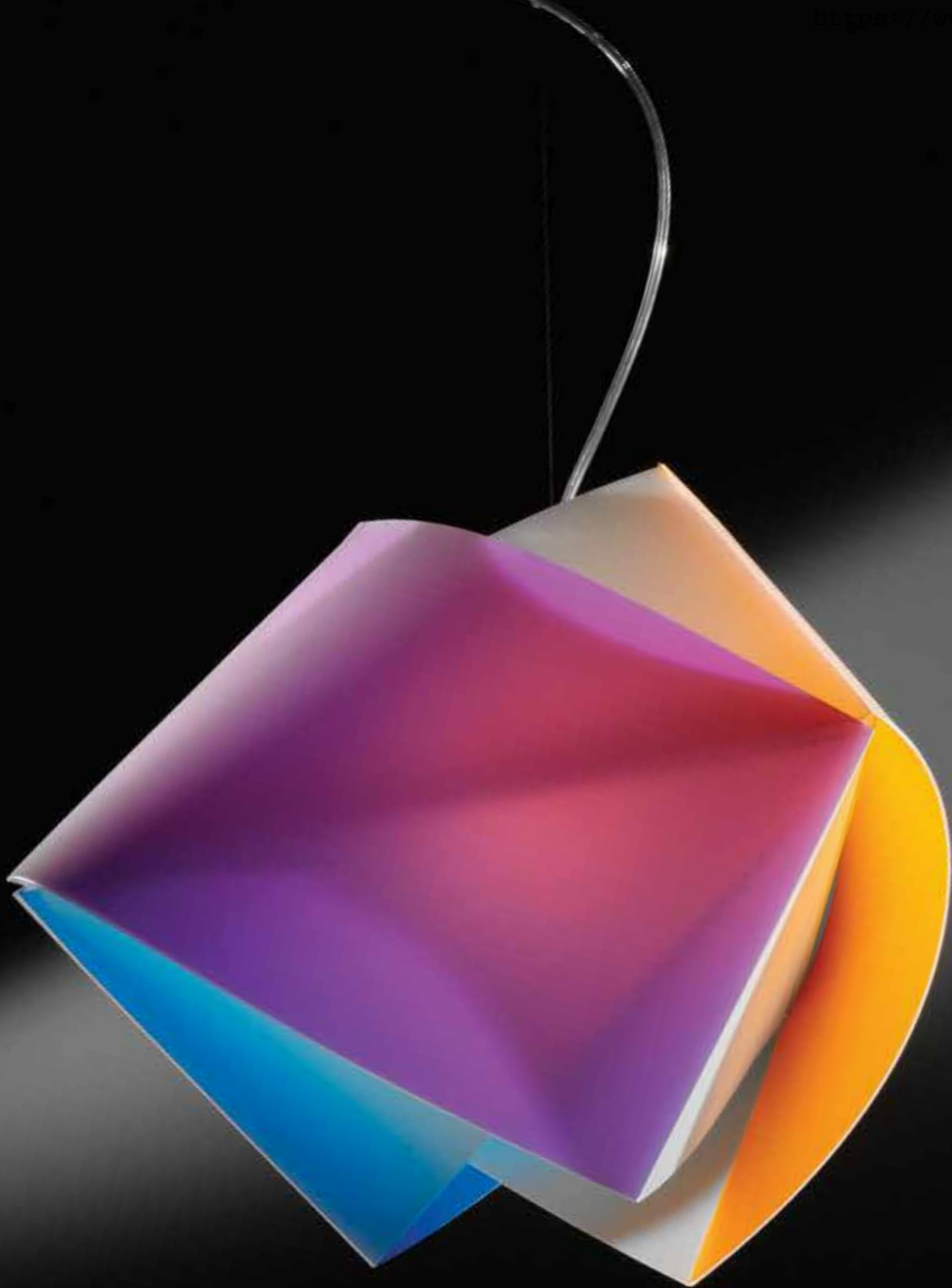

GEMMY

SUSPENSION

Bulbs: 1X8W LED Filament - E27 or E26

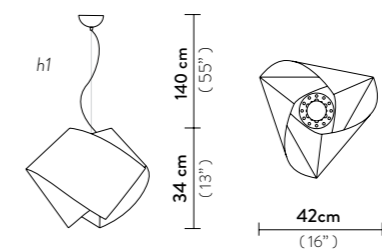

h1: maximum cable length

Made of: Opalflex®

TABLE LAMP

Bulbs: 1X4W LED Filament - E14 or E12

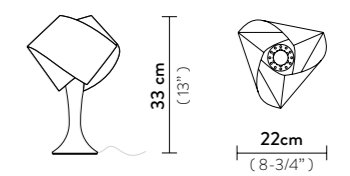

With: White steel base

Made of: Opalflex®



Price List: page 64



BIOS BY NIGEL COATES

Un design morbido ed avvolgente per una lampada lineare, decorata tono su tono. Bios nasce dalla sovrapposizione di due strati di Opalflex® dai quali, attraverso i fori irregolari, filtra una luce che crea suggestivi riflessi e un particolare gioco di luci e di ombre. Disponibile in quattro versioni, ceiling, suspension, floor e table, è una lampada versatile e discreta adatta ad ogni interior.

A linear lamp with a soft, welcoming design that superimposes pale shades, one on another. Bios has two layers of Opalflex®, both with carefully selected incisions that let the light shine through, creating suggestive reflections and shadows. This versatile and discreet lamp is available in four versions: ceiling, suspension, floor and table, bringing warmth to any interior.



BIOS XL

FLOOR LAMP

Bulbs: 3 X 8W LED Filament - E27 or E26

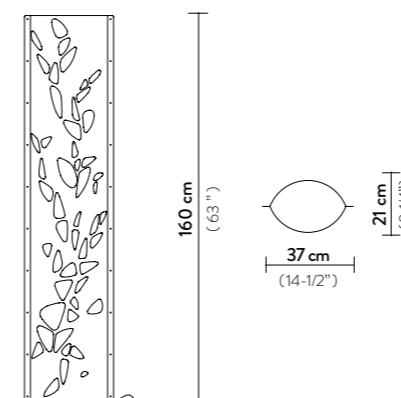

With: Aluminium Profiles - Dimmer Included

Made of: Opalflex®

Price List: page 86



WHITE

BIOS S

TABLE LAMP

Bulbs: 1 X 4W LED Filament - E14 or E12

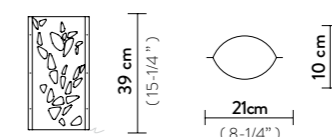

With: Aluminium Profiles - Dimmer Included

Made of: Opalflex®

NODO BIOS

SUSPENSION

Bulbs: 1 X 8W LED Filament - E27 or E26

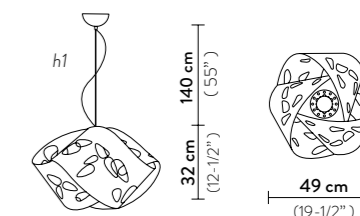

h1: maximum cable length

Made of: Opalflex®

Price List: page 86



WHITE

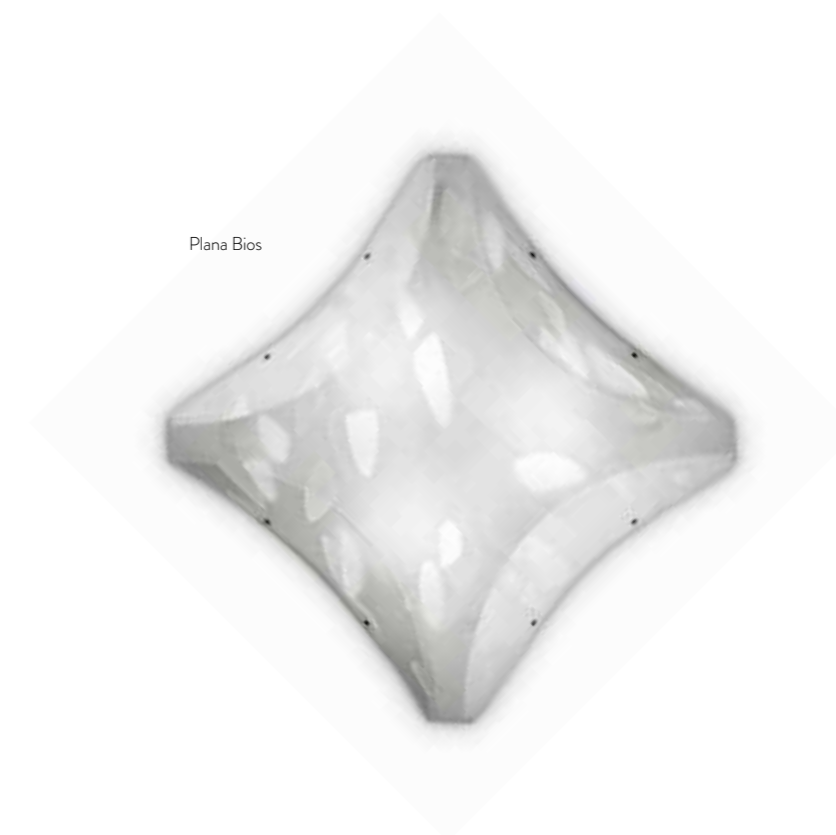

BIOS L

CEILING / WALL LAMP

Bulbs: 4 X 8W LED Filament - E27 or E26

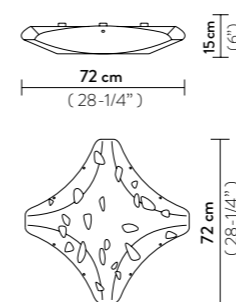

With: MagneticSystem®
Made of: Opalflex®

BIOS M

CEILING / WALL LAMP

Bulbs: 3 X 8W LED Filament - E27 or E26

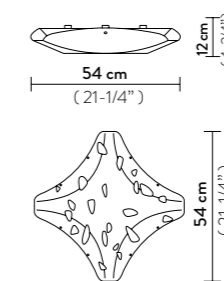

With: MagneticSystem®
Made of: Opalflex®

BIOS S

CEILING / WALL LAMP

Bulbs: 2 X 8W LED Filament - E27 or E26

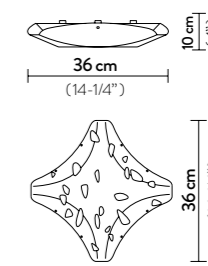

With: MagneticSystem®
Made of: Opalflex®

Price List: page 86

WHITE



LUÌ

BY ADRIANO
RACHELE

Ispirata all'uccellino più piccolo al mondo da cui prende il nome, la sua luce è protettiva ed accogliente, come il nido a cui si vuole sempre tornare. Delicata, sognante e fantasiosa incanta grazie ai giochi di riflessi ed ombre creati dai tanti rami che avvolgono il diffusore luminoso, che sboccia dai rami come fosse un fiore. Aggiunge un tocco di magia ad ogni interior minimal, colorato ed ecosostenibile.

Lui takes its name and inspiration from the smallest bird on earth. Its welcoming, protective light is much like a nest in which one wants to return to again and again. Dreamlike, delicate, and imaginative, the lamp enchants with plays of reflections and shadows created by its numerous branches surrounding the diffusor. Any minimalist or vivacious and sustainable interior receives a touch of magic with Lui.



LUI

SUSPENSION

Bulbs: 1X8W LED Filament - E27 or E26

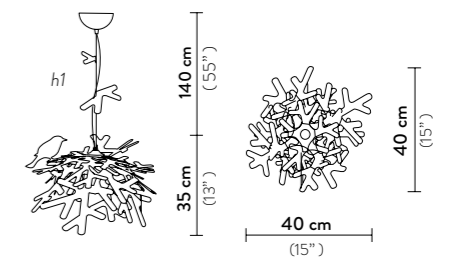

h1: maximum cable length

Made of: Opalflex® / Cristalflex®



Price List: page 93

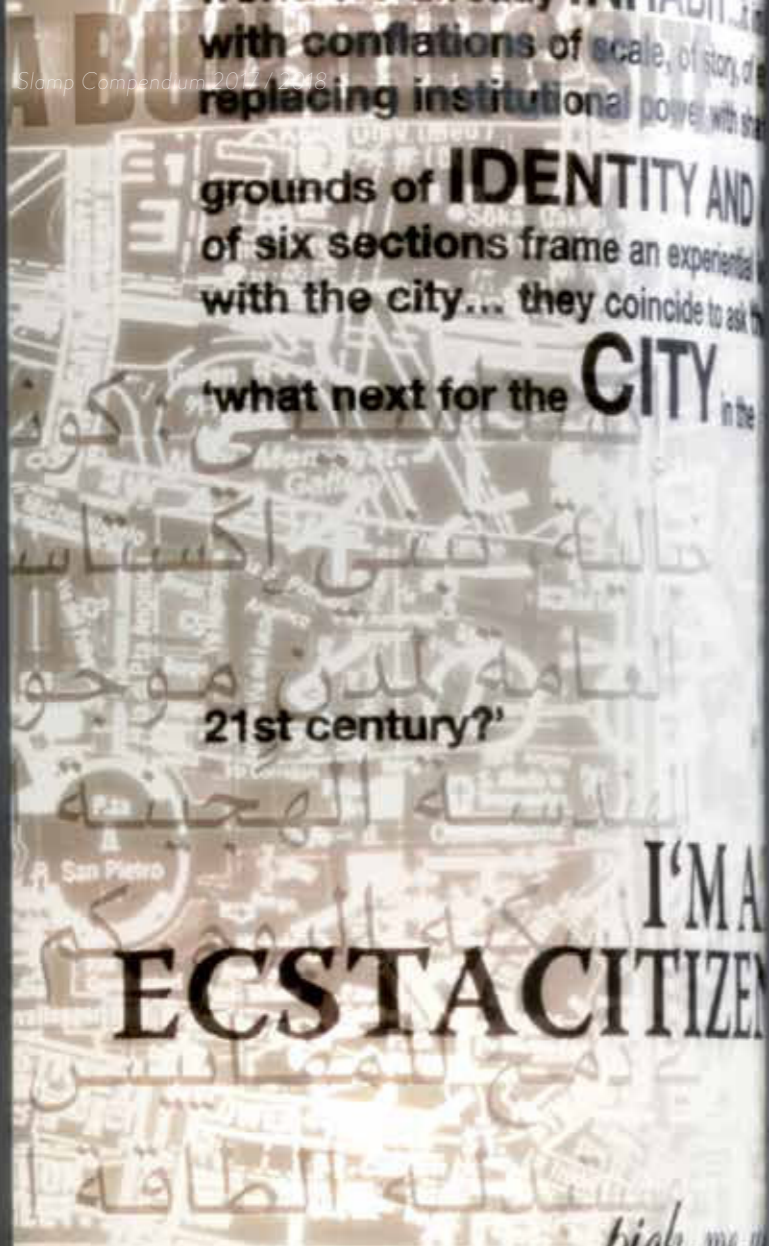

ECSTACITY BY NIGEL COATES

Ecstacity è la realizzazione tridimensionale del concept sull'architettura racchiuso all'interno dell'omonimo libro di Nigel Coates. Esattamente come nel volume si dà spazio all'immaginario di una città ideale incoraggiando una lettura non lineare, allo stesso modo in questa lampada da terra si gioca con una serie di stampe serigrafiche sovrapposte che esaltano la profondità del decoro - frasi originali estratte dal libro - combinando estetica e funzionalità.

Ecstacity is Nigel Coates' three-dimensional version of the architecture described in his book of the same name. Just as his edition made space for an ideal, non-linear imaginary city, the design plays on a series of superimposed graphic printing, phrasing pulled straight from the pages of the book, that brings decorative depth to the functional, aesthetic floor lamp.

ECSTACITY

FLOOR LAMP

Bulbs: 3 X 8W LED Filament - E27 or E26

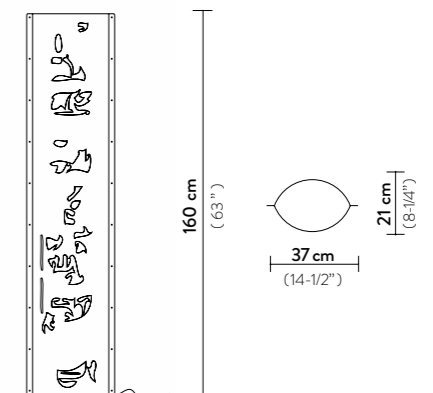

With: Aluminium Profiles - Dimmer Included

Made of: Opalflex®

Price List: page 66



ECSTACITY
DECOR

VISIONARY
ADAPTABLE
SENSUAL
MYSTERIOUS
INNOVATIVE
ACCESSIBLE
RELIABLE
ASPIRATIONAL
ORIGINAL
RESOURCEFUL
EXPERIMENTAL
SUGGESTIVE

SLAMP®
THE LEADING LIGHT

MADE IN ITALY

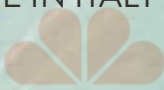
LUSTROGRAD
ОПТОВЫЕ ПРОДАЖИ СВЕТИЛЬНИКОВ